

## Wireless Power Design Kit - Medium Power Order Code: 760308MP, Version 1.0

**Transmitter Module, Receiver Module and LED Load Module compliant to Qi v1.2.2**

### ● Abstract

ROHM Semiconductor and Würth Elektronik (WE) offers this wireless power design kit (order code 760308MP) to demonstrate the advantages of wireless power and to give developers the opportunity to test and integrate a wireless power solution into their application.

This design kit is based on the Qi specification 1.2.2 and supports the Extended Power Profile (EPP) from the Wireless Power Consortium (WPC). Receiver and transmitter are also backwards compatible with the low power mode (Baseline Power Profile).

This manual describes the setup and basic usage of this design kit.

### ● Description of Featured Products

The BD57020MWV is an IC for wireless power transmitter applications. This device is composed of pre-driver inverters for the TX coil, Qi compliant controller for the communication and demodulating circuit, GPIO, XO buffer, and I2C interface. The BD57020MWV works as an analog frontend driven by a general-purpose microcontroller. In this design kit the transmitter is controlled by the MCU ML610Q772-B03, which has all necessary firmware to be compliant with the WPC Qi ver.1.2.2 standard and supports wireless power transmission up to 15W. BD57015GWL is a wireless power receiver IC. The device integrates a fully synchronous rectifier circuit with low-impedance FETs, Qi and PMA compliant packet controller, adjustable regulated voltage output, and an open-drain output terminal to communicate with the power transmitter using amplitude modulation. The BD57015GWL is targeted at mobile applications implementing wireless charging compliant to Qi Medium Power (including Low Power) and PMA standard. For further details, please also consult the relevant product datasheets at <http://www.rohm.com>.

For further details about the TX and RX coils please visit Würth Elektronik at <http://www.we-online.de>.

### ● Key Specifications

- Mains power input voltage .....100-240VAC
- Regulated input voltage.....19VDC
- Maximum transmitted power.....15W
- Maximum receiver output power.....10W (15W <sup>Note 1</sup>)
- WPC Qi compliance.....v1.2.2



### ● Features

- Plug & Play Wireless Power Design Kit
- Meets the Qi Standard of the Wireless Power Consortium (WPC)
- Complete solution consisting of TX, RX and LED Load module
- Flexible and modular approach for fast integration of wireless power in your product design
- Low power (baseline power profile) and Medium power (extended power profile) operation
- Visit [www.rohm.com/web/eu/wirelesspowerkit](http://www.rohm.com/web/eu/wirelesspowerkit) for details

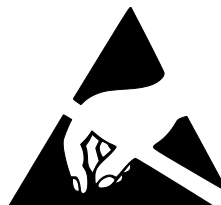

Note 1: Will need simple RX Module modification. If you require 15W get in touch with ROHM customer support (see chapter 4).

## Table of Contents

Cover Page.....	1
Abstract .....	1
Description of Featured Products .....	1
Key Specifications .....	1
Features .....	1
1. Introduction.....	3
2. Hardware Description .....	3
2.1 Block Diagram.....	3
2.2 Key components .....	4
2.3 Schematic, Gerber Files and Bill of Materials.....	4
3. Design Kit Setup and Operating Instructions .....	5
3.1 Warnings.....	5
3.2 Instructions for Safe Use.....	5
3.3 Power Supply.....	5
3.4 Transmitter (TX) Module .....	6
3.5 Receiver (RX) Module.....	8
3.6 LED Load Module .....	9
4. Customer Support.....	9

## 1. Introduction

WPC's Qi standard for medium power has attracted attention as a next-generation standard for inductive power transmission that will enable wireless charging of tablet PCs while allowing smartphones and other mobile devices to be charged up to three times faster than the existing low power standard (5W). In addition, an advanced Foreign Object Detection (FOD) function is included to provide improved safety by detecting foreign metallic right before the power transfer has started to ensure the safety of sensitive electronics and to avoid overheating of foreign metallic objects.

ROHM has developed this design kit to enable engineers to faster develop wireless charging in general and explore the detailed usage of its core components on the transmitter side with the BD57020MWV and on the receiver side with the BD57015GWL.

This manual is valid for Design Kit Version 1.0. It provides guidelines to quickly setup the hardware for fast and easy evaluation of the wireless charging system and the featured key components. For further details and updates about the TX and RX ICs and other ROHM products, please also consult the relevant product datasheets and general information at <http://www.rohm.com>.

Please also check [www.rohm.com/web/eu/wirelesspowerkit](http://www.rohm.com/web/eu/wirelesspowerkit) for downloading the latest version of this document and additional useful information such as application notes, Gerber files, schematics, bill of materials, etc.

## 2. Hardware Description

### 2.1 Block Diagram

The design kit consists of the following components:

- TX Module Demonstration of charging pad function using TX IC, MCU, discrete full bridge, QFOD circuit, TX coil
- RX Module Demonstration of wireless power receiver inside a mobile device using Receiver IC, RX coil
- LED Shield Wireless powered LED light using LED array + driver, MCU
- Power Supply Wide input range mains power supply with different adapters for international use

A block diagram of the design kit is depicted in Figure 1. The transmitter design corresponds to the MP-A7 as defined in the WPC Qi specification 1.2.2. The necessary 19V<sub>DC</sub> input voltage is provided with the included mains adapter.

The key component of the Transmitter Module is the transmitter IC BD57020MWV. This IC integrates all necessary analog functions to operate as a wireless power transmitter such as full bridge pre-driver and demodulation circuit. The digital control is realized by the microcontroller ML610Q772-B03 which is directly supplied by one of the LDO outputs of the TX IC. The quality factor foreign object detection (Q-FOD) circuit is realized with discrete components.

The coil area is the wireless power interface to the receiver. It is covered by a 2mm thick acryl glass plate which acts as distance spacer and physical protection of the resonant circuit which may carry high AC voltages in certain conditions.

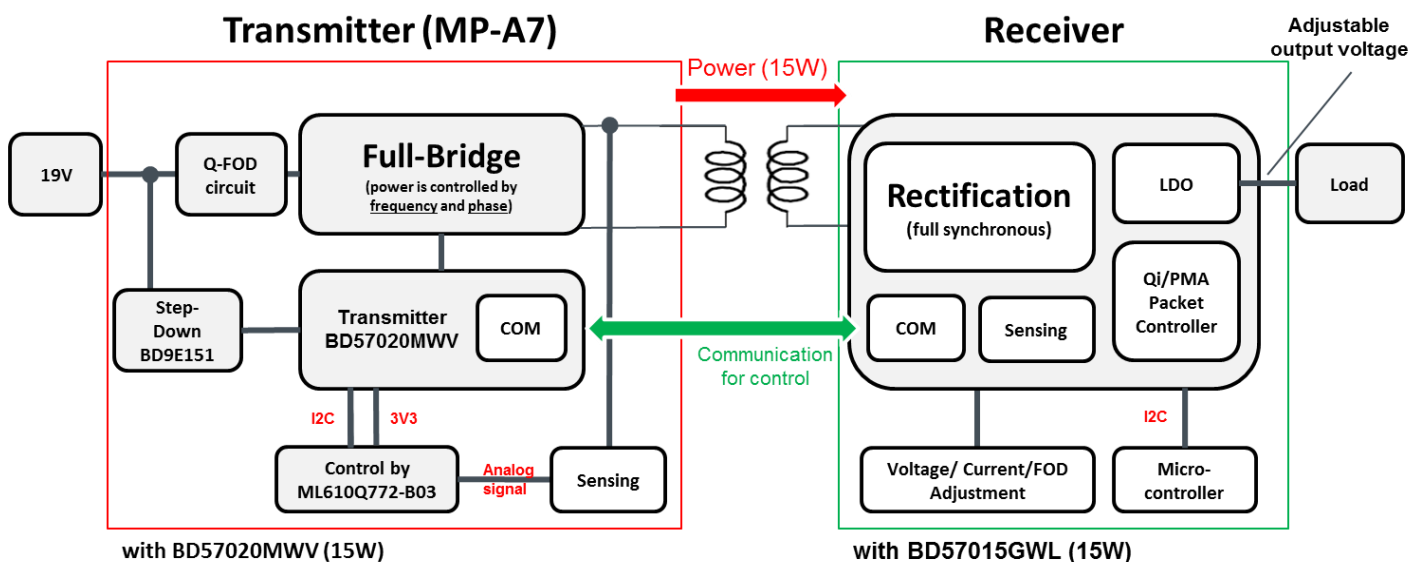

Figure 1: Design Kit Block Diagram

The Receiver Module integrates all necessary functions to act as a wireless power receiver such as full synchronous rectification, power sensing, modulator, Qi/PMA packet controller and an adjustable output LDO. The key component is the BD57015GWL receiver IC.

The MCU on the receiver side is required for the proper configuration of the RX IC. Without the configuration the RX is not sending the needed parameters during the negotiation/calibration phase to enable the medium power transfer mode. The I2C interface is used to set the necessary parameters such as the LDO output voltage, the current limit, FOD and QFOD settings.

The receiver system of this design kit uses a modular approach: The Load Module is designed as stackable shield on top of the Receiver Module. This allows easy replacement of the demonstrative LED matrix load and receiver side MCU. The user may design a custom load/MCU shield or connect to the RX Module pin headers by jumper cables.

Interoperability between transmitter and receiver is achieved by complying with the WPC Qi standard. The Transmitter Module can supply power to any Qi compliant receiver and equally the Receiver Module can receive power from any Qi compliant transmitter. Also, both modules are backwards compatible with a low power (baseline power profile) counterpart.

## 2.2 Key components

The purpose of the EVK is the evaluation of the key components used to realize the wireless power system. Table 1 gives an overview of the different ICs and coils. For more detailed information about these devices please follow the given hyperlinks to the individual web pages and datasheets.

Manufacturer	Product	Part Number	Used in
Rohm Semiconductor	Wireless Power Transmitter IC	<a href="#">BD57020MWV</a>	TX Module
Rohm Semiconductor	Step-Down Switching Regulator	<a href="#">BD9E151NUX</a>	TX Module
Rohm Semiconductor	Wireless Power Receiver IC	<a href="#">BD57015GWL</a>	RX Module
Rohm Semiconductor (Lapis)	Microcontroller	<a href="#">ML610Q772-B03</a>	TX Module
Rohm Semiconductor (Lapis)	Microcontroller	<a href="#">ML610Q112</a>	LED Module
Rohm Semiconductor	LED driver 8ch	<a href="#">BD6142AMUV</a>	LED Module
Würth Elektronik eiSos	Transmitter Coil	<a href="#">760 308 110</a>	TX Module
Würth Elektronik eiSos	Receiver Coil	<a href="#">760 308 102 207</a>	RX Module

Table 1: Key components used in the design kit

## 2.3 Schematic, Gerber Files and Bill of Materials

Please visit [www.rohm.com/web/eu/wirelesspowerkit](http://www.rohm.com/web/eu/wirelesspowerkit) for downloading the latest production data consisting of the schematics, assembly data, Gerber files and Bill of Materials (BOMs) for all three modules of this design kit.

### 3. Design Kit Setup and Operating Instructions

#### 3.1 Warnings

- This design kit must only be operated by trained professionals.
- This design kit should be operated in a well ventilated environment and, if used inside a case, the case should not be covered.
- This design kit should be placed on a stable, flat, non-conductive surface in use and should not be contacted by conductive items.
- All peripherals used with the design kit should comply with relevant standards for the country of use and be marked accordingly to ensure that safety and performance requirements are met.
- Where peripherals are connected that do not include the cable or connector, the cable or connector used must offer adequate insulation and operation in order that the requirements of the relevant performance and safety are met.
- The connection of incompatible devices to the design kit may affect compliance or result in damage to the unit and invalidate the warranty.



## WARNING

*The AC voltage in the resonant tank may reach voltage up to 250Vpp under certain conditions. Therefore, it is covered by acryl glass to ensure human safety. Nevertheless take care not to touch the PCB by bare hand and use the required level of isolation when probing test points on the PCB.*

#### 3.2 Instructions for Safe Use

- Do not expose the design kit to water, moisture or place on a conductive surface whilst in operation.
- Take care whilst handling to avoid mechanical or electrical damage to the printed circuit board and components.
- Avoid handling the printed circuit board while it is powered. Only handle by the edges to minimize the risk of electrostatic discharge damage.
- Do not short any outputs to each other, to the supply or to GND.
- Do not operate the design kit outside its specified ratings.
- Take care to monitor the PCB and IC temperatures in particular when operating with high power loads and do not exceed the absolute maximum ratings of all components.

#### 3.3 Power Supply

Apply one of the included mains plugs (North America / Japan, Great Britain, Central Europe) with the power supply and connect the AC plug to mains. Connect the DC plug of the mains adapter to **CONN1** of the Transmitter Module.

In case another power supply is used please make sure to comply with the electrical characteristics as the provided mains adapter (see Table 2). Take care not to reverse polarize the applied voltage.

Parameter	Specification
Input voltage	100-240V AC, 50/60Hz
Output voltage	19V DC $\pm$ 5%
Output current rating	2A

Table 2: Mains adapter specification



Figure 2: Included power supply with 3 different mains adapter plugs

### 3.4 Transmitter (TX) Module

When power is provided to the TX Module at CONN1, **LED1** will light green to indicate presence of the 19V input voltage. Additionally LED2 will light green when the 5V DC/DC converter has started up. The Transmitter Module is now in low power “idle” mode where it is periodically pinging on the wireless interface to detect presence of a receiver device.

The stacked RX+LED Modules (or any other Qi compliant receiver) can now be placed anywhere on the **Coil Area** (as shown in Figure 3) and the wireless power transmission will start. In low power mode (WPC baseline power profile) the **LED LP** will light green to indicate successful and ongoing power transfer. In addition the **LED MP** will also light in medium power mode (WPC extended power profile).

There is a red color **LED FL** to indicate failure modes. Slow blinking means the power transfer is still established but Field Strength Limitation (FSL) is active. This is usually caused when the receiver has slightly moved out of alignment and safe power transfer is not guaranteed. In this case the ROHM Receiver Module will communicate to stop power transfer if the system will not have recovered from this failure mode within ~3s. This condition is indicated by fast blinking failure mode LED. Other reasons for stopped power transfer can be Foreign Object Detection (FOD), Under Voltage Lockout (UVLO) or “End of Power Transfer” (EPT) requested by the receiver. The system can only recover from this failure mode if the receiver is removed from the coil area. The transmitter will then go to idle mode.

The different operating modes and status LED indications are summarized in Table 3. Please check Figure 4 for the local positions of described LEDs, inputs and outputs.

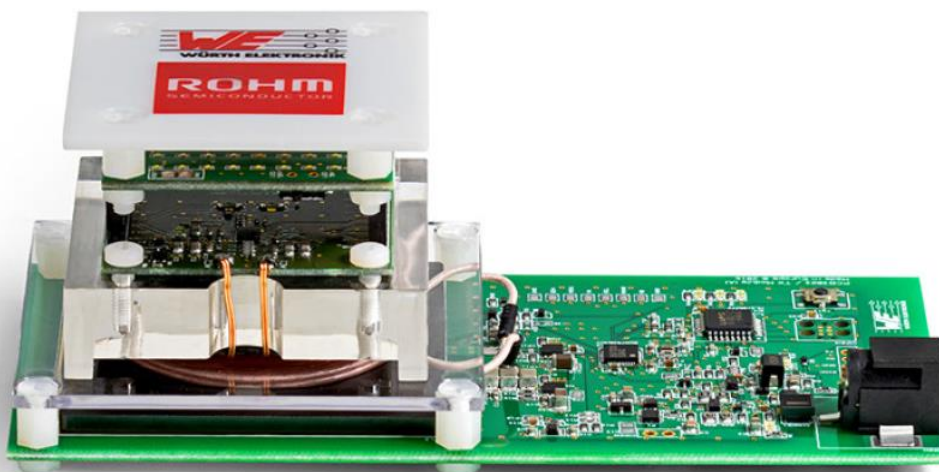

Figure 3: Stacked RX+LED Module placed on coil area of TX Module

LED Name			Operating Mode Description
LP	MP	FL	
Off	Off	Off	Idle mode with periodic pings for receiver detection. Very low power consumption.
On	Off	Off	LP mode (WPC baseline power profile) with up to 5W load power.
On	On	Off	MP mode (WPC extended power profile) with up to 10W (15W) load power.
On	On or Off	Slowly Blinking	Power transfer is still established but Field Strength Limitation (FSL) is active. (see above).
Off	Off	Fast Blinking	Power transfer has been stopped due to Foreign Object Detection (FOD), EPT or Under Voltage Lockout (UVLO). The system can only recover from this failure mode if the receiver is removed from the coil area. The transmitter will then go to idle mode.

Table 3: Operating Modes indicated by status LEDs on the Transmitter Module

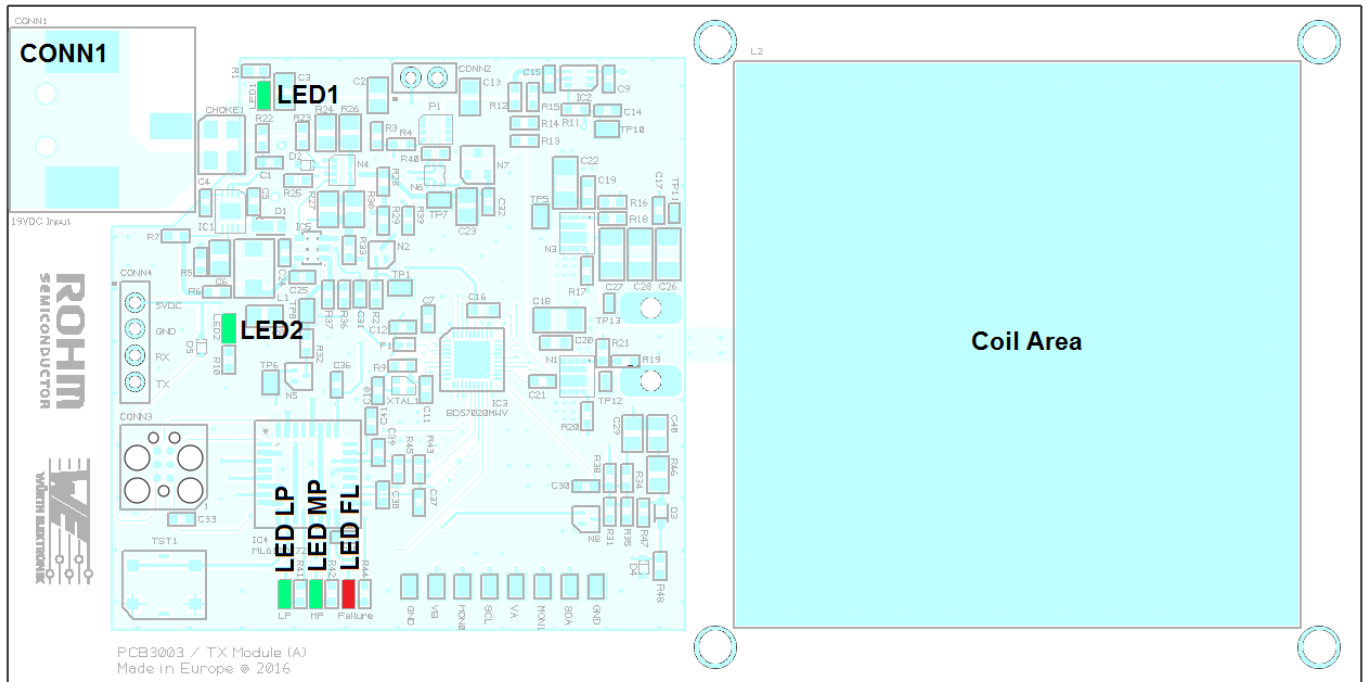

Figure 4: Transmitter Board with indication of inputs, outputs and status LEDs

Parameter	Specification
Input voltage	19V DC $\pm$ 5%
Maximum output AC power	15W
Qi compliance	1.2.2
Transmitter Type	MP-A7

Table 4: Transmitter Module specification

Basic electrical specifications of the Transmitter Module are summarized in Table 4. The AC output power of the transmitter is high enough so that a receiver can deliver 15W maximum to its load.

### 3.5 Receiver (RX) Module

When the wireless transmitted power reaches the Receiver Module, **LED1** will light green to indicate a “power good” function. Also **LED2** and **LED3** are lit white and shine into the acryl glass cube. The push button **TST1** can be used to reset the receiver if necessary. See Figure 5 for LED and push button positions.

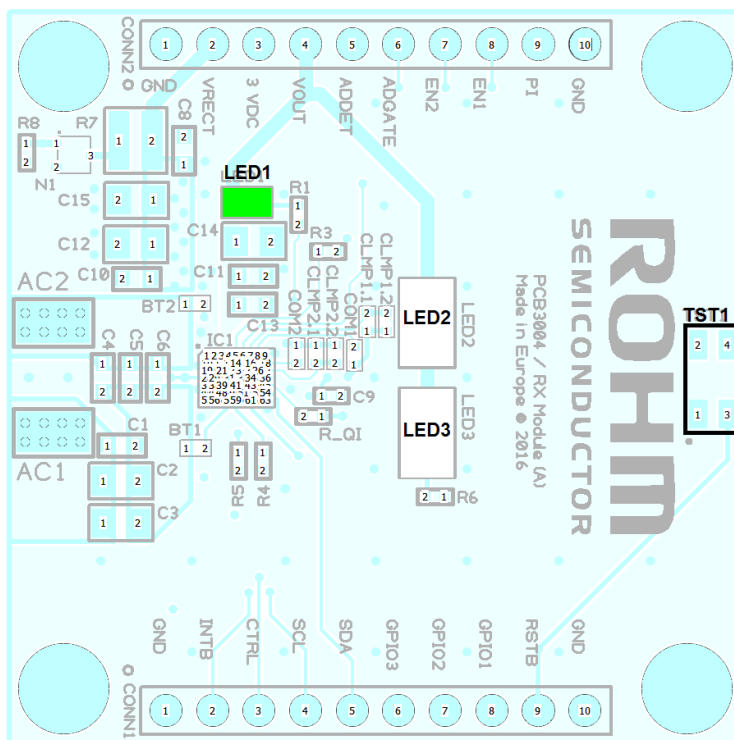

Figure 5: Receiver Module, top view

The basic electrical specifications of the Receiver Module are summarized in Table 5. Please note the maximum receiver load power must not exceed 10W with the version 1.0 of the design kit. If a load power of 15W is really required please get in contact with ROHM customer support for help on necessary hardware and software modifications.

Parameter	Specification
Output voltage delivered to load	10V DC
Maximum power delivered to load (at 20°C ambient temperature)	10W (RX IC case temperature ~ 60°C)
	15W (RX IC case temperature ~ 85°C) <sup>1</sup>
Qi compliance	1.2.2

Note 1: Will need simple RX Module modification. If you require 15W get in touch with ROHM customer support (see chapter 4).

Table 5: Receiver Module specification



### 3.6 LED Load Module

When the LED Load Module is powered by the RX Module via the VOUT pin the **LED69** on the bottom side (see Figure 6) will light white. When **Sw1** is turned on (default setting) the LED driver is enabled and the LED matrix on the top side will light. Turning **Sw2** off will disable the LED matrix load. In this case a user defined load may be attached between **VOUT** and **GND** as indicated in Figure 7. Please take care not to exceed the maximum specified RX load power.

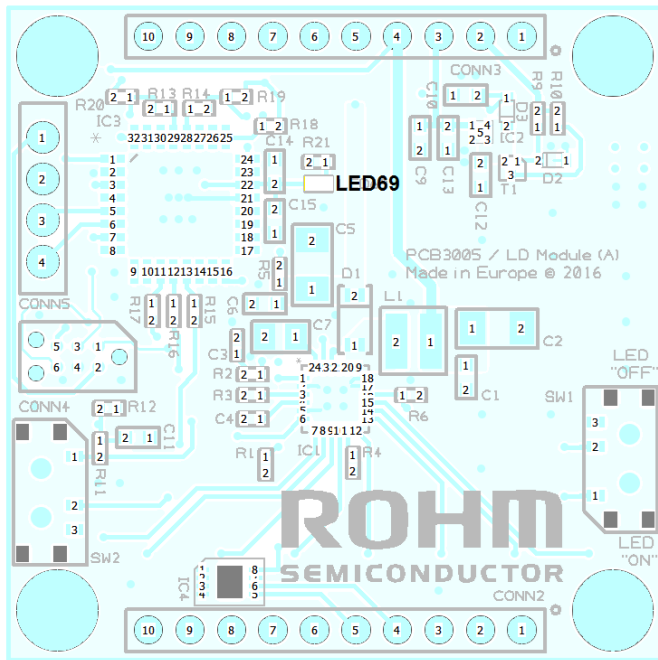

Figure 6: LED Module, bottom view

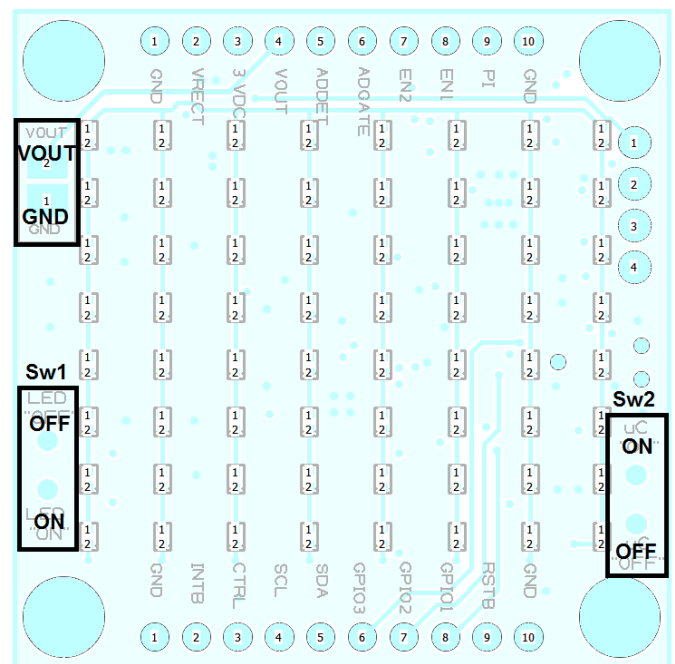

Figure 7: LED Module, top view

Slide switch on LED Module		Configured Mode
Sw1: LED <sup>1</sup>	Sw2: uC <sup>1</sup>	
On	On	Default Mode. The MCU is enabled and uses the I2C interface to configure the RX IC BD57015 in Medium Power Mode. The LED driver is enabled, thus the LED matrix load is lit as a demonstrative load.
Off	On	The MCU is enabled and uses the I2C interface to configure the RX IC BD57015 in Medium Power Mode. The load to the receiver is disabled. A user defined load may be attached to the VOUT pad on the LED Module.
Don't care	Off	The MCU is disabled so the RX IC BD57015 works in Low Power Mode by default. The LED loads are turned off independent from Sw1 setting. The user may attach a custom MCU to the 2.85V supply pin and a load to the VOUT pad of the LED module. In case the 2.85V supply is not needed the LED Module can be removed, and the user may stack a customized MCU/load shield.

Note 1: Please change the position of these switches only when the stacked RX+LED Load Module are unpowered

Table 6: Mode configuration by slide switches of LED Module

## 4. Customer Support

If any further technical support is required when operating with the design kit please contact ROHM Semiconductor or Würth Elektronik with your enquiry.

**ROHM Semiconductor**  
[wirelesspower@de.rohmeurope.com](mailto:wirelesspower@de.rohmeurope.com)

**Würth Elektronik**  
[wirelesspower@we-online.com](mailto:wirelesspower@we-online.com)

## Notes

This EVK is

- only to be used as device under test for research and development purposes.
- only to be operated by trained professionals.
- not to be assembled into a final product.

### **Additional Terms, warnings, restrictions and disclaimers of the Würth Elektronik and ROHM Semiconductor Wireless Power Design Kit (later defined as DESIGN KIT)**

Würth Elektronik (later defined as WE) and ROHM Semiconductor (later defined as ROHM) provide the enclosed DESIGN KIT under the following conditions: The user has to bear all responsibility and liability for the proper and safe handling with regard to this DESIGN KIT. The user shall indemnify WE and ROHM from all claims arising from the handling or utilization of the DESIGN KIT. In the case this DESIGN KIT does not comply with the specifications indicated in the Quick Start Guide and Manual, the DESIGN KIT may be returned within 30 days from the date of delivery for a full reimbursement of the purchase price.

THE FOREGOING LIMITED WARRANTY IS THE EXCLUSIVE WARRANTY MADE BY WE and ROHM TO THE USER AND IS IN LIEU OF ALL OTHER WARRANTIES, EXPRESSED, IMPLIED, OR STATUTORY, INCLUDING ANY WARRANTY OF MERCHANTABILITY OR FITNESS FOR ANY PARTICULAR PURPOSE. EXCEPT TO THE EXTENT OF THE INDEMNITY SET FORTH ABOVE, NEITHER PARTY SHALL BE LIABLE TO THE OTHER FOR ANY INDIRECT, SPECIAL, INCIDENTAL OR CONSEQUENTIAL DAMAGES.

**Please read the Quick Start Guide and Manual carefully prior to handling the DESIGN KIT. This Guide contains essential safety information regarding temperatures and voltages.**

No license is granted under any patent right or other intellectual property rights of WE or ROHM covering or relating to any machine, process and procedure, or combination in which such the DESIGN KIT or services might be or are used. Our arrangement with the user is not exclusive as WE and ROHM are currently working with a large number of customers for DESIGN KITS. WE and ROHM bear no liability for applications assistance, customer product design, software performance, or infringement of patents or services described in the Quick Start Guide and Manual.

### **Code of federal regulations**

As noted in the DESIGN KIT Quick Start Guide and Manual, this DESIGN KIT and/or accompanying hardware may or may not be subject to and compliant with the Code of Federal Regulations, Title 47, Part 15. For DESIGN KITS annotated to comply with the Code of Federal Regulations, Title 47, Part 15. Operation is subject to the following two conditions:

(1) This DESIGN KIT may not cause harmful interference, and (2) this DESIGN KIT must accept any interference received, including interference that may cause undesired operation. Changes or modifications not expressly approved by the party responsible for compliance could void the user's authority to operate the equipment. This DESIGN KIT as a Class A digital apparatus complies with Canadian ICES-003. Changes or modifications not expressly approved by the party responsible for compliance could void the users' authority to operate the equipment.

For DESIGN KITS annotated as not subject to or compliant with the Code of Federal Regulations, Title 47, Part 15. This DESIGN KIT is intended for use for ENGINEERING DEVELOPMENT, DESIGNSTRATION, OR EVALUATION PURPOSES ONLY and is not considered by WE and ROHM to be a finished end product fit for general consumer use. It generates, uses, and can radiate radio frequency energy and has not been tested for compliance with the limits of computing devices pursuant to the Code of Federal Regulations, Title 47, Part 15, which are designed to provide reasonable protection against radio frequency interference. Operation of the equipment may cause interference with radio communications, in which case the user at its own expense will be required to take whatever measures may be required to correct this interference.

**For Feasibility Evaluation Only, in Laboratory/Development Environments.** The DESIGN KIT is not a complete product. It is intended exclusively for preliminary feasibility evaluation in laboratory/development environments by technically qualified electronics experts. Those experts mandatory have to be familiar with the dangers and application risks in connection with handling electrical mechanical components, systems and subsystems. It should not be used as an end product or as a part of an end product.

**Your Sole Responsibility and Risk. You acknowledge, represent and agree that:**

- a) You have unique awareness of the Federal, State and local regulatory requirements (including but not limited to Food and Drug Administration regulations, if applicable) which affects your products and which refers to your use (and/or the use of your employees, affiliates, contractors or designees) of the DESIGN KIT for evaluation, testing and other purposes.
- b) You are unlimited and exclusive responsible for the safety of your DESIGN KIT and for the compliance with all relevant laws and other applicable regulatory requirements. Further you have to assure the safety of any activities to be conducted by you and/or your employees, affiliates, contractors or designees, using the DESIGN KIT. You are also responsible to ensure that any interfaces (electronic and/or mechanical) between the DESIGN KIT and any human body are designed with suitable isolation and means to safely limit the accessible leakage currents to minimize the risk of electrical shock hazard.
- c) Since the DESIGN KIT is not a completed product, it may not meet all applicable regulatory and safety compliance standards (such as UL, CSA, VDE, CE, RoHS and WEEE) which may normally be associated with similar completed products. You assume full responsibility to determine and/ or assure compliance with any such standards and related certifications as may be applicable. You have to use reasonable safeguards to ensure that your use of the DESIGN KIT will not result in any property damage, injury or death, even if the DESIGN KIT should fail to perform as specified or expected.

**Certain Instructions.** It is important to handle this DESIGN KIT within WE's and ROHM's recommended specifications and environmental considerations as described in the Quick Start Guide and Manual. Surpassing the specified DESIGN KIT classifications (including but not limited to input and output voltage, current, power, and environmental ranges) may cause property damage, personal injury or death. If there are questions concerning these classifications please contact a WE external sales representative before connecting interface electronics including input power and intended loads. Any loads applied beyond the specified output range may result in unintended and/or inexact operation and/or possible lasting damage to the DESIGN KIT and/or interface electronics. Please consult the DESIGN KIT Quick Start Guide and Manual prior to connecting any load to the DESIGN KIT output. If there is uncertainty regarding the load specification, please contact a WE or ROHM external sales representative. During normal operation, some circuit components may have case temperatures greater than 60°C as long as the input and output are maintained at a normal ambient operating temperature. These components include but are not limited to linear regulators, switching transistors, pass transistors, and current sense resistors which can be identified by using the DESIGN KIT schematic published in the DESIGN KIT Quick Start Guide and Manual.

Please be aware that the devices of the DESIGN KIT may be very warm in case of placing the measurement test setup close to the DESIGN KIT during normal procedure. Please ensure that only qualified personnel educated in electronic measurement and diagnostics usually found in development environments should use these DESIGN KITS.

**Agreement to Defend, Indemnify and Hold Harmless.** You agree to defend, indemnify and hold WE, ROHM, its licensors and their representatives harmless from and against any and all claims, damages, losses, expenses, costs and liabilities (collectively, „Claims“) arising out of or in connection with any use of the DESIGN KIT that is not in accordance with the terms of the agreement. This obligation shall apply whether Claims arise under law of tort or contract or any other legal theory, and even if the DESIGN KIT fails to perform as specified or expected.

**Safety-Critical or Life-Critical Applications.** If you intend to evaluate the components for possible use in safety critical applications (such as life support) where a failure of the WE or ROHM product would reasonably be expected to cause severe personal injury or death, such as devices which are classified as FDA Class III or similar classification,



Thank you for your accessing to ROHM product information.  
More detailed product information and catalogs are available, please contact us.

**ROHM Customer Support System**

<http://www.rohm.com/contact/>



Компания «ЭлектроПласт» предлагает заключение долгосрочных отношений при поставках импортных электронных компонентов на взаимовыгодных условиях!

Наши преимущества:

- Оперативные поставки широкого спектра электронных компонентов отечественного и импортного производства напрямую от производителей и с крупнейших мировых складов;
- Поставка более 17-ти миллионов наименований электронных компонентов;
- Поставка сложных, дефицитных, либо снятых с производства позиций;
- Оперативные сроки поставки под заказ (от 5 рабочих дней);
- Экспресс доставка в любую точку России;
- Техническая поддержка проекта, помощь в подборе аналогов, поставка прототипов;
- Система менеджмента качества сертифицирована по Международному стандарту ISO 9001;
- Лицензия ФСБ на осуществление работ с использованием сведений, составляющих государственную тайну;
- Поставка специализированных компонентов (Xilinx, Altera, Analog Devices, Intersil, Interpoint, Microsemi, Aeroflex, Peregrine, Syfer, Eurofarad, Texas Instrument, Miteq, Cobham, E2V, MA-COM, Hittite, Mini-Circuits, General Dynamics и др.);

Помимо этого, одним из направлений компании «ЭлектроПласт» является направление «Источники питания». Мы предлагаем Вам помощь Конструкторского отдела:

- Подбор оптимального решения, техническое обоснование при выборе компонента;
- Подбор аналогов;
- Консультации по применению компонента;
- Поставка образцов и прототипов;
- Техническая поддержка проекта;
- Защита от снятия компонента с производства.



#### Как с нами связаться

**Телефон:** 8 (812) 309 58 32 (многоканальный)

**Факс:** 8 (812) 320-02-42

**Электронная почта:** [org@eplast1.ru](mailto:org@eplast1.ru)

**Адрес:** 198099, г. Санкт-Петербург, ул. Калинина, дом 2, корпус 4, литера А.