

NTC Thermistors



⚠Note • Please read rating and ⚠CAUTION (for storage, operating, rating, soldering, mounting and handling) in this catalog to prevent smoking and/or burning, etc.
• This catalog has only typical specifications. Therefore, please approve our product specifications or transact the approval sheet for product specifications before ordering.

EU RoHS Compliant

- All the products in this catalog comply with EU RoHS.
- EU RoHS is "the European Directive 2011/65/EU on the Restriction of the Use of Certain Hazardous Substances in Electrical and Electronic Equipment."
- For more details, please refer to our website 'Murata's Approach for EU RoHS' (<http://www.murata.com/info/rohs.html>).

Contents

Product specifications are as of December 2014.

| | |
|---|-----|
| Part Numbering | p2 |
| Basic Characteristics | p6 |
| <hr/> | |
| 1 Temperature Sensor and Compensation 0201 (0603) Size | p7 |
| <hr/> | |
| 2 Temperature Sensor and Compensation 0402 (1005) Size | p8 |
| <hr/> | |
| 3 Temperature Sensor and Compensation 0603 (1608) Size | p10 |
| <hr/> | |
| 4 Temperature Sensor and Compensation 0805 (2012) Size | p12 |
| <hr/> | |
| Temperature Sensor and Compensation Chip Type Standard Land Pattern Dimensions | p13 |
| Temperature Sensor and Compensation Chip Type Temperature Characteristics (Center Value) | p14 |
| Temperature Sensor and Compensation Chip Type ⚠Caution/Notice | p18 |
| Temperature Sensor and Compensation Chip Type Package | p22 |
| <hr/> | |
| 5 Temperature Sensor Thermo String Type | p25 |
| Temperature Sensor Thermo String Type Specifications and Test Methods | p26 |
| <hr/> | |
| 6 Temperature Sensor Lead Type | p28 |
| Temperature Sensor Lead Type Specifications and Test Methods | p29 |
| <hr/> | |
| 7 Temperature Sensor Lead Insulation Type (Radial Type) | p30 |
| Temperature Sensor Lead Insulation Type (Radial Type) Specifications and Test Methods .. | p31 |
| <hr/> | |
| Temperature Sensor Thermo String/Lead Type Temperature Characteristics (Center Value) | p32 |
| Temperature Sensor Thermo String/Lead Type ⚠Caution/Notice | p33 |
| Temperature Sensor Thermo String/Lead Type Package | p35 |
| <hr/> | |
| 8 Inrush Current Suppression Lead Type | p36 |
| Current - R Ratio (RT/R25)/ Current - Temperature Characteristics (Typical) .. | p38 |
| Inrush Current Suppression Lead Type ⚠Caution/Notice | p42 |
| Inrush Current Suppression Lead Type Package | p44 |

Please check the MURATA home page (<http://www.murata.com/>) if you cannot find the part number in the catalog.

● Part Numbering

NTC Thermistors for Temp. Sensor and Compensation Chip Type

(Part Number)

| | | | | | | | |
|----|---|----|----|-----|---|----|----|
| NC | P | 18 | XH | 103 | J | 03 | RB |
| ① | ② | ③ | ④ | ⑤ | ⑥ | ⑦ | ⑧ |

① Product ID

| Product ID | |
|------------|---------------------------|
| NC | NTC Thermistors Chip Type |

② Series

| Code | Series |
|----------|---------------------------|
| P | Plated Termination Series |

③ Dimensions (L×W)

| Code | Dimensions (L×W) | EIA |
|-----------|------------------|------|
| 03 | 0.60×0.30mm | 0201 |
| 15 | 1.00×0.50mm | 0402 |
| 18 | 1.60×0.80mm | 0603 |
| 21 | 2.00×1.25mm | 0805 |

④ Temperature Characteristics

| Code | Temperature Characteristics |
|-----------|-------------------------------|
| XC | Nominal B-Constant 3100—3149K |
| XF | Nominal B-Constant 3250—3299K |
| XH | Nominal B-Constant 3350—3399K |
| XM | Nominal B-Constant 3500—3549K |
| XQ | Nominal B-Constant 3650—3699K |
| XV | Nominal B-Constant 3900—3949K |
| XW | Nominal B-Constant 3950—3999K |
| WB | Nominal B-Constant 4050—4099K |
| WD | Nominal B-Constant 4150—4199K |
| WF | Nominal B-Constant 4250—4299K |
| WL | Nominal B-Constant 4450—4499K |
| WM | Nominal B-Constant 4500—4549K |

⑤ Resistance

Expressed by three-digit alphanumerics. The unit is ohm (Ω). The first and second figures are significant digits, and the third figure expresses the number of zeros that follow the two figures.

Ex.

| Code | Resistance |
|------------|---------------|
| 102 | 1k Ω |
| 103 | 10k Ω |
| 104 | 100k Ω |

⑥ Resistance Tolerance

| Code | Resistance Tolerance |
|----------|----------------------|
| D | $\pm 0.5\%$ |
| F | $\pm 1\%$ |
| E | $\pm 3\%$ |
| J | $\pm 5\%$ |

⑦ Individual Specifications

Structures and other specifications are expressed by two figures.

Ex.

| Code | Individual Specifications |
|-----------|---------------------------|
| 03 | Standard Type |

⑧ Packaging

| Code | Packaging |
|-----------|--------------------------------------|
| RA | Plastic Taping 4mm Pitch (4000 pcs.) |
| RB | Paper Taping 4mm Pitch (4000 pcs.) |
| RC | Paper Taping 2mm Pitch (10000 pcs.) |
| RL | Paper Taping 2mm Pitch (15000 pcs.) |

NTC Thermistor for Temperature Sensor Thermo String Type

(Part Number)

| | | | | | | | | | |
|------------|----------|-----------|-----------|------------|----------|----------|----------|----------|------------|
| NXF | T | 15 | XH | 103 | F | A | 2 | B | 025 |
| ① | ② | ③ | ④ | ⑤ | ⑥ | ⑦ | ⑧ | ⑨ | ⑩ |

① Product ID

| Product ID | |
|------------|---|
| NXF | NTC Thermistors Sensor Thermo String Type |

② Individual Specifications

| Code | Individual Specifications |
|----------|---------------------------|
| T | Commercial Type |

③ Chip Dimensions

| Code | Dimensions (LxT) | EIA |
|-----------|------------------|------|
| 15 | 1.00 x 0.50mm | 0402 |

④ Temperature Characteristics

| Code | Temperature Characteristics |
|-----------|-------------------------------|
| XH | Nominal B-Constant 3350–3399K |
| XV | Nominal B-Constant 3900–3949K |
| WB | Nominal B-Constant 4050–4099K |
| WF | Nominal B-Constant 4250–4299K |

⑤ Resistance

Expressed by three figures. The unit is (Ω). The first and second figures are significant digits, and the third figure expresses the number of zeros that follow the two figures.

Ex.

| Code | Resistance |
|------------|------------|
| 103 | 10kΩ |
| 104 | 100kΩ |

⑥ Resistance Tolerance

| Code | Resistance Tolerance |
|----------|----------------------|
| F | ±1% |

⑦ Lead Wire Type

| Code | Lead Wire Type |
|----------|--|
| A | ø0.3mm Copper Lead Wire with Polyurethane Coat |

⑧ Shape of the Lead Wire Kink

| Code | Shape of the Lead Wire Kink |
|----------|-----------------------------|
| 1 | Twisted Lead Wire Type |
| 2 | Standard Type |

⑨ Packaging

| Code | Packaging |
|----------|-----------|
| B | Bulk |

⑩ Dimensions (Full Length)

| Code | Dimensions (Full Length) |
|------------|--------------------------|
| 025 | 25mm |
| 030 | 30mm |
| 040 | 40mm |
| 050 | 50mm |
| 060 | 60mm |
| 070 | 70mm |
| 080 | 80mm |
| 090 | 90mm |
| 100 | 100mm |
| 110 | 110mm |
| 120 | 120mm |
| 130 | 130mm |
| 140 | 140mm |
| 150 | 150mm |

NTC Thermistor for Temperature Sensor/Lead Type

(Part Number)

| | | | | | | | | | |
|------------|----------|-----------|-----------|------------|----------|----------|----------|----------|------------|
| NXR | T | 15 | XH | 103 | F | A | 1 | B | 040 |
| ① | ② | ③ | ④ | ⑤ | ⑥ | ⑦ | ⑧ | ⑨ | ⑩ |

① Product ID

| Product ID | |
|------------|---------------------------------|
| NXR | NTC Thermistor Sensor/Lead Type |

② Individual Specifications

| Code | Individual Specifications |
|----------|---------------------------|
| T | Commercial Type |

③ Chip Dimensions

| Code | Dimensions (LxT) |
|-----------|------------------|
| 15 | 1.00 x 0.50mm |

④ Temperature Characteristics

| Code | Temperature Characteristics |
|-----------|-------------------------------|
| XH | Nominal B-Constant 3350–3399K |
| XM | Nominal B-Constant 3500–3549K |
| XV | Nominal B-Constant 3900–3949K |
| WB | Nominal B-Constant 4050–4099K |
| WF | Nominal B-Constant 4250–4299K |

⑤ Resistance

Expressed by three figures. The unit is (Ω). The first and second figures are significant digits, and the third figure expresses the number of zeros that follow the two figures.

Ex.

| Code | Resistance |
|------------|------------|
| 202 | 2.0kΩ |
| 103 | 10kΩ |
| 104 | 100kΩ |

⑥ Resistance Tolerance

| Code | Resistance Tolerance |
|----------|----------------------|
| F | ±1% |
| E | ±3% |
| J | ±5% |

⑦ Lead Wire Type

| Code | Lead Wire Type |
|----------|--|
| A | Lead Type: ø0.4mm Copper-clad Fe Wire, Tinned Lead Insulation Type: ø0.46mm Cu Wire with Coat |

⑧ Shape of the Lead Wire

| Code | Shape of the Lead Wire |
|----------|--------------------------------------|
| 1 | Lead Spacing 2.5mm |
| 3 | Lead Spacing 5.0mm |
| 5 | Lead Spacing 2.5mm (Insulation Type) |

⑨ Packaging

| Code | Packaging |
|----------|------------------|
| A | Ammo Pack Taping |
| B | Bulk |

⑩ Dimensions (Full Length)

| Code | Dimensions (Full Length) |
|------------|--|
| 010 | 10mm |
| 020 | 20mm |
| 025 | 25mm (Insulation Type only) |
| 030 | 30mm |
| 035 | 35mm (Insulation Type only) |
| 040 | 40mm |
| 045 | 45mm (Insulation Type only) |
| 016 | 16mm (Taping Type/Lead distance between reference and bottom planes) |

NTC Thermistors for Inrush Current Suppression Lead Type

(Part Number)

| | | | | | |
|-----------|------------|------------|----------|-----------|-----------|
| NT | PA7 | 160 | L | BM | B0 |
| ① | ② | ③ | ④ | ⑤ | ⑥ |

① Product ID

| Product ID | |
|------------|-----------------|
| NT | NTC Thermistors |

② Series

| Code | Series | Nominal Body Diameter |
|------------|--------------------------------------|-----------------------|
| PA5 | Inrush Current Suppression Lead Type | ø5mm |
| PA6 | | ø6mm |
| PA7 | | ø7mm |
| PA9 | | ø9mm |
| PAA | | ø10mm |
| PAD | | ø13mm |
| PAJ | | ø18mm |
| PAN | | ø22mm |

③ Resistance

Expressed by three-digit alphanumerics. The unit is ohm (Ω). The first and second figures are significant digits, and the third figure expresses the number of zeros that follow the two figures. If there is a decimal point, it is expressed by the capital letter "R." In this case, all figures are significant digits.

Ex.

| Code | Resistance |
|------------|-------------|
| 3R0 | 3 Ω |
| 100 | 10 Ω |

④ Resistance Tolerance

| Code | Resistance Tolerance |
|----------|----------------------|
| L | ±15% |

⑤ Individual Specifications

The lead structure and other specifications are expressed by two-digit alphanumerics.

| Code | Individual Specifications | Body Diameter |
|-----------|---------------------------|---------------|
| B1 | Standard Type (Ammo Pack) | ø7mm, ø9mm |
| BM | Standard Type (Bulk) | ø7mm, ø9mm |
| D6 | Standard Type (Ammo Pack) | ø10mm, ø13mm |
| DK | Standard (Bulk) | ø18mm, ø22mm |
| DN | Standard (Bulk) | ø10mm, ø13mm |

⑥ Packaging

| Code | Packaging |
|-----------|------------------|
| A0 | Ammo Pack Taping |
| B0 | Bulk |

Basic Characteristics

Basic Characteristics

1. Zero-power Resistance of Thermistor: R

$$R = R_0 \exp B (1/T - 1/T_0) \quad \dots\dots\dots(1)$$

R: Resistance in ambient temperature T (K)
 (K: absolute temperature)

R₀: Resistance in ambient temperature T₀ (K)

B: B-Constant of Thermistor

2. B-Constant

as (1) formula

$$B = \ell n (R/R_0) / (1/T - 1/T_0) \quad \dots\dots\dots(2)$$

3. Thermal Dissipation Constant

When electric power P (mW) is spent in ambient temperature T₁ and thermistor temperature rises T₂, the formula is as follows

$$P = C (T_2 - T_1) \quad \dots\dots\dots(3)$$

C: Thermal dissipation constant (mW/°C)

Thermal dissipation constant is varied with dimensions, measurement conditions, etc.



4. Thermal Time Constant

Period in which the thermistor's temperature will change 63.2% of its temperature difference from ambient temperature T₀ (°C) to T₁ (°C).



Performance

| Item | Condition |
|-------------------------------|---|
| Resistance | Measured by zero-power in specified ambient temperature. |
| B-Constant | Calculated between two specified ambient temperatures by the next formula. T and T ₀ is absolute temperature (K). $B = \frac{\ell n (R/R_0)}{1/T - 1/T_0}$ |
| Thermal Dissipation Constant | Shows necessary electric power that Thermistor's temperature rises 1°C by self-heating. It is calculated by the next formula (mW/°C). $C = \frac{P}{T - T_0}$ |
| Rated Electric Power | Shows the required electric power that causes the thermistor's temperature to rise to a specified temperature by self-heating, at ambient temperature of 25 °C. |
| Permissible Operating Current | It is possible to keep the thermistor's temperature rising max. 1°C. |

Please inquire about test conditions and ratings.

NTC Thermistors

Temperature Sensor and Compensation 0201 (0603) Size

Chip NTC Thermistors' Ni barrier termination provides excellent solderability and their unique construction offers high stability in the application's environment.

■ Features

1. Excellent solderability and high stability in the application's environment
2. Excellent long-term stability
3. High accuracy in resistance and B-Constant
4. Reflow soldering possible
5. NCP series are recognized by UL/cUL.
(UL1434, File No.E137188)

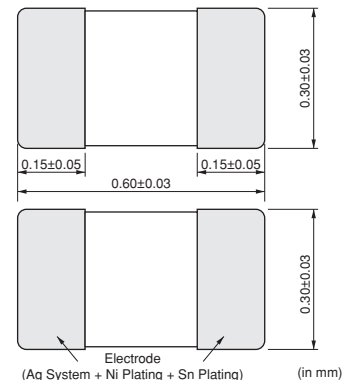

■ Applications

1. Temperature compensation for transistors, ICs, and crystal oscillators in mobile communications
2. Temperature sensor for rechargeable batteries

| Part Number | Resistance (25°C) (ohm) | B-Constant (25-50°C) (K) | B-Constant (25-80°C) (Reference Value) (K) | B-Constant (25-85°C) (Reference Value) (K) | B-Constant (25-100°C) (Reference Value) (K) | Permissible Operating Current (25°C) (mA) | Rated Electric Power (25°C) (mW) | Typical Dissipation Constant (25°C) (mW/°C) |
|-----------------|-------------------------|--------------------------|--|--|---|---|----------------------------------|---|
| NCP03XM102□05RL | 1.0k | 3500 ±1% | 3539 | 3545 | 3560 | 1.00 | 100 | 1 |
| NCP03XM152□05RL | 1.5k | 3500 ±1% | 3539 | 3545 | 3560 | 0.81 | 100 | 1 |
| NCP03XM222□05RL | 2.2k | 3500 ±1% | 3539 | 3545 | 3560 | 0.67 | 100 | 1 |
| NCP03XM332□05RL | 3.3k | 3500 ±1% | 3539 | 3545 | 3560 | 0.55 | 100 | 1 |
| NCP03XM472□05RL | 4.7k | 3500 ±1% | 3539 | 3545 | 3560 | 0.46 | 100 | 1 |
| NCP03XH682□05RL | 6.8k | 3380 ±1% | 3428 | 3434 | 3455 | 0.38 | 100 | 1 |
| NCP03XH103F05RL | 10k ±1% | 3380 ±1% | 3428 | 3434 | 3455 | 0.31 | 100 | 1 |
| NCP03XH103□05RL | 10k | 3380 ±1% | 3428 | 3434 | 3455 | 0.31 | 100 | 1 |
| NCP03XV103□05RL | 10k | 3900 ±1% | 3930 | 3934 | 3944 | 0.31 | 100 | 1 |
| NCP03XH153□05RL | 15k | 3380 ±1% | 3428 | 3434 | 3455 | 0.25 | 100 | 1 |
| NCP03XH223□05RL | 22k | 3380 ±1% | 3428 | 3434 | 3455 | 0.21 | 100 | 1 |
| NCP03WF333□05RL | 33k | 4250 ±1% | 4303 | 4311 | 4334 | 0.17 | 100 | 1 |
| NCP03WB473□05RL | 47k | 4050 ±3% | 4101 | 4108 | 4131 | 0.14 | 100 | 1 |
| NCP03WL473□05RL | 47k | 4485 ±1% | 4537 | 4543 | 4557 | 0.14 | 100 | 1 |
| NCP03WF683□05RL | 68k | 4250 ±1% | 4303 | 4311 | 4334 | 0.12 | 100 | 1 |
| NCP03WL683□05RL | 68k | 4485 ±1% | 4537 | 4543 | 4557 | 0.12 | 100 | 1 |
| NCP03WF104F05RL | 100k ±1% | 4250 ±1% | 4303 | 4311 | 4334 | 0.10 | 100 | 1 |
| NCP03WF104□05RL | 100k | 4250 ±1% | 4303 | 4311 | 4334 | 0.10 | 100 | 1 |
| NCP03WL104□05RL | 100k | 4485 ±1% | 4537 | 4543 | 4557 | 0.10 | 100 | 1 |
| NCP03WL154□05RL | 150k | 4485 ±1% | 4537 | 4543 | 4557 | 0.08 | 100 | 1 |
| NCP03WL224□05RL | 220k | 4485 ±1% | 4537 | 4543 | 4557 | 0.06 | 100 | 1 |

□ is filled with resistance tolerance codes (E: ±3%, J: ±5%).

Rated Electric Power shows the required electric power that the thermistor's temperature rise to 125°C by self-heating, at ambient temperature of 25 °C.

Operating Temperature Range: -40°C to +125°C

NTC Thermistors

Temperature Sensor and Compensation 0402 (1005) Size

2

Chip NTC Thermistors' Ni barrier termination provides excellent solderability and their unique construction offers high stability in the application's environment.

■ Features

1. Excellent solderability and high stability in the application's environment
2. Excellent long-term stability
3. High accuracy in resistance and B-Constant
4. Reflow soldering possible
5. Same B-constant in the same resistance in the three sizes (0805 size / 0603 size / 0402 size)
Downsize is easy for design.
6. NCP series are recognized by UL/cUL.
(UL1434, File No.E137188)

■ Applications

1. Temperature compensation for transistors, ICs, and crystal oscillators in mobile communications
2. Temperature sensor for rechargeable batteries
3. Temperature compensation of LCD
4. Temperature compensation in general use of electric circuits

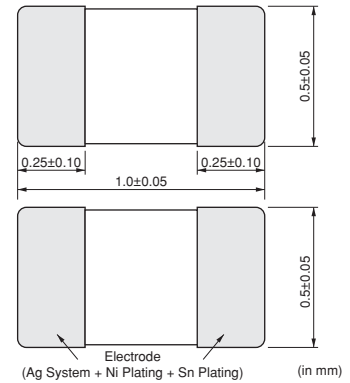

| Part Number | Resistance (25°C) (ohm) | B-Constant (25-50°C) (K) | B-Constant (25-80°C) (Reference Value) (K) | B-Constant (25-85°C) (Reference Value) (K) | B-Constant (25-100°C) (Reference Value) (K) | Permissible Operating Current (25°C) (mA) | Rated Electric Power (25°C) (mW) | Typical Dissipation Constant (25°C) (mW/°C) |
|-----------------|-------------------------|--------------------------|--|--|---|---|----------------------------------|---|
| NCP15XC220□03RC | 22 | 3100 ±3% | 3126 | 3128 | 3136 | 6.70 | 100 | 1 |
| NCP15XC330□03RC | 33 | 3100 ±3% | 3126 | 3128 | 3136 | 5.50 | 100 | 1 |
| NCP15XC470□03RC | 47 | 3100 ±3% | 3126 | 3128 | 3136 | 4.60 | 100 | 1 |
| NCP15XC680□03RC | 68 | 3100 ±3% | 3126 | 3128 | 3136 | 3.80 | 100 | 1 |
| NCP15XF101□03RC | 100 | 3250 ±3% | 3282 | 3284 | 3296 | 3.10 | 100 | 1 |
| NCP15XF151□03RC | 150 | 3250 ±3% | 3282 | 3284 | 3296 | 2.50 | 100 | 1 |
| NCP15XM221□03RC | 220 | 3500 ±3% | 3539 | 3545 | 3560 | 2.10 | 100 | 1 |
| NCP15XM331□03RC | 330 | 3500 ±3% | 3539 | 3545 | 3560 | 1.70 | 100 | 1 |
| NCP15XQ471□03RC | 470 | 3650 ±2% | 3688 | 3693 | 3706 | 1.40 | 100 | 1 |
| NCP15XQ681□03RC | 680 | 3650 ±3% | 3688 | 3693 | 3706 | 1.20 | 100 | 1 |
| NCP15XQ102□03RC | 1.0k | 3650 ±2% | 3688 | 3693 | 3706 | 1.00 | 100 | 1 |
| NCP15XW152□03RC | 1.5k | 3950 ±3% | 3982 | 3987 | 3998 | 0.81 | 100 | 1 |
| NCP15XW222□03RC | 2.2k | 3950 ±3% | 3982 | 3987 | 3998 | 0.67 | 100 | 1 |
| NCP15XW332□03RC | 3.3k | 3950 ±3% | 3982 | 3987 | 3998 | 0.55 | 100 | 1 |
| NCP15XM472□03RC | 4.7k | 3500 ±2% | 3539 | 3545 | 3560 | 0.46 | 100 | 1 |
| NCP15XW472□03RC | 4.7k | 3950 ±3% | 3982 | 3987 | 3998 | 0.46 | 100 | 1 |
| NCP15XW682□03RC | 6.8k | 3950 ±3% | 3982 | 3987 | 3998 | 0.38 | 100 | 1 |
| NCP15XH103D03RC | 10k ±0.5% | 3380 ±0.7% | 3428 | 3434 | 3455 | 0.31 | 100 | 1 |
| NCP15XH103F03RC | 10k ±1% | 3380 ±1% | 3428 | 3434 | 3455 | 0.31 | 100 | 1 |
| NCP15XH103□03RC | 10k | 3380 ±1% | 3428 | 3434 | 3455 | 0.31 | 100 | 1 |
| NCP15XV103□03RC | 10k | 3900 ±3% | 3930 | 3934 | 3944 | 0.31 | 100 | 1 |
| NCP15XW153□03RC | 15k | 3950 ±3% | 3982 | 3987 | 3998 | 0.25 | 100 | 1 |
| NCP15XW223□03RC | 22k | 3950 ±3% | 3982 | 3987 | 3998 | 0.21 | 100 | 1 |
| NCP15WL223□03RC | 22k | 4485 ±1% | 4537 | 4543 | 4557 | 0.21 | 100 | 1 |
| NCP15WB333□03RC | 33k | 4050 ±3% | 4101 | 4108 | 4131 | 0.17 | 100 | 1 |
| NCP15WL333□03RC | 33k | 4485 ±1% | 4537 | 4543 | 4557 | 0.17 | 100 | 1 |

Continued on the following page. ↗

⚠Note • Please read rating and ⚠CAUTION (for storage, operating, rating, soldering, mounting and handling) in this catalog to prevent smoking and/or burning, etc.
 • This catalog has only typical specifications. Therefore, please approve our product specifications or transact the approval sheet for product specifications before ordering.

↳ Continued from the preceding page.

| Part Number | Resistance (25°C) (ohm) | B-Constant (25-50°C) (K) | B-Constant (25-80°C) (Reference Value) (K) | B-Constant (25-85°C) (Reference Value) (K) | B-Constant (25-100°C) (Reference Value) (K) | Permissible Operating Current (25°C) (mA) | Rated Electric Power (25°C) (mW) | Typical Dissipation Constant (25°C) (mW/°C) |
|------------------------|-------------------------|--------------------------|--|--|---|---|----------------------------------|---|
| NCP15WB473D03RC | 47k ±0.5% | 4050 ±0.5% | 4101 | 4108 | 4131 | 0.14 | 100 | 1 |
| NCP15WB473F03RC | 47k ±1% | 4050 ±1% | 4101 | 4108 | 4131 | 0.14 | 100 | 1 |
| NCP15WB473□03RC | 47k | 4050 ±1% | 4101 | 4108 | 4131 | 0.14 | 100 | 1 |
| NCP15WL473□03RC | 47k | 4485 ±1% | 4537 | 4543 | 4557 | 0.14 | 100 | 1 |
| NCP15WD683□03RC | 68k | 4150 ±3% | 4201 | 4209 | 4232 | 0.12 | 100 | 1 |
| NCP15WL683□03RC | 68k | 4485 ±1% | 4537 | 4543 | 4557 | 0.12 | 100 | 1 |
| NCP15WF104D03RC | 100k ±0.5% | 4250 ±0.5% | 4303 | 4311 | 4334 | 0.10 | 100 | 1 |
| NCP15WF104F03RC | 100k ±1% | 4250 ±1% | 4303 | 4311 | 4334 | 0.10 | 100 | 1 |
| NCP15WF104□03RC | 100k | 4250 ±1% | 4303 | 4311 | 4334 | 0.10 | 100 | 1 |
| NCP15WL104□03RC | 100k | 4485 ±1% | 4537 | 4543 | 4557 | 0.10 | 100 | 1 |
| NCP15WL154□03RC | 150k | 4485 ±1% | 4537 | 4543 | 4557 | 0.08 | 100 | 1 |
| NCP15WM154□03RC | 150k | 4500 ±3% | 4571 | 4582 | 4614 | 0.08 | 100 | 1 |
| NCP15WM224□03RC | 220k | 4500 ±3% | 4571 | 4582 | 4614 | 0.06 | 100 | 1 |
| NCP15WM474□03RC | 470k | 4500 ±3% | 4571 | 4582 | 4614 | 0.04 | 100 | 1 |

□ is filled with resistance tolerance codes (E: ±3%, J: ±5%).

Rated Electric Power shows the required electric power that the thermistor's temperature rise to 125°C by self-heating, at ambient temperature of 25 °C.

Operating Temperature Range: -40°C to +125°C

2

NTC Thermistors

Temperature Sensor and Compensation 0603 (1608) Size

Chip NTC Thermistors' Ni barrier termination provides excellent solderability and their unique construction offers high stability in the application's environment.

■ Features

1. Excellent solderability and high stability in the application's environment
2. Excellent long-term stability
3. High accuracy in resistance and B-constant
4. Flow / Reflow soldering possible
5. Same B-Constant in the same resistance in the three sizes (0805 size / 0603 size / 0402 size)
Downsize is easy for design.
6. NCP series are recognized by UL/cUL.
(UL1434, File No.E137188)

■ Applications

1. Temperature compensation for transistors, ICs, and crystal oscillators in mobile communications
2. Temperature sensor for rechargeable batteries
3. Temperature compensation of LCD
4. Temperature compensation in general use of electric circuits



| Part Number | Resistance (25°C) (ohm) | B-Constant (25-50°C) (K) | B-Constant (25-80°C) (Reference Value) (K) | B-Constant (25-85°C) (Reference Value) (K) | B-Constant (25-100°C) (Reference Value) (K) | Permissible Operating Current (25°C) (mA) | Rated Electric Power (25°C) (mW) | Typical Dissipation Constant (25°C) (mW/°C) |
|-----------------|-------------------------|--------------------------|--|--|---|---|----------------------------------|---|
| NCP18XF101□03RB | 100 | 3250 ±3% | 3282 | 3284 | 3296 | 3.10 | 100 | 1 |
| NCP18XF151□03RB | 150 | 3250 ±3% | 3282 | 3284 | 3296 | 2.50 | 100 | 1 |
| NCP18XM221□03RB | 220 | 3500 ±3% | 3539 | 3545 | 3560 | 2.10 | 100 | 1 |
| NCP18XM331□03RB | 330 | 3500 ±3% | 3539 | 3545 | 3560 | 1.70 | 100 | 1 |
| NCP18XQ471□03RB | 470 | 3650 ±2% | 3688 | 3693 | 3706 | 1.40 | 100 | 1 |
| NCP18XQ681□03RB | 680 | 3650 ±3% | 3688 | 3693 | 3706 | 1.20 | 100 | 1 |
| NCP18XQ102□03RB | 1.0k | 3650 ±2% | 3688 | 3693 | 3706 | 1.00 | 100 | 1 |
| NCP18XW152□03RB | 1.5k | 3950 ±3% | 3982 | 3987 | 3998 | 0.81 | 100 | 1 |
| NCP18XW222□03RB | 2.2k | 3950 ±3% | 3982 | 3987 | 3998 | 0.67 | 100 | 1 |
| NCP18XW332□03RB | 3.3k | 3950 ±3% | 3982 | 3987 | 3998 | 0.55 | 100 | 1 |
| NCP18XM472□03RB | 4.7k | 3500 ±2% | 3539 | 3545 | 3560 | 0.46 | 100 | 1 |
| NCP18XW472□03RB | 4.7k | 3950 ±3% | 3982 | 3987 | 3998 | 0.46 | 100 | 1 |
| NCP18XW682□03RB | 6.8k | 3950 ±3% | 3982 | 3987 | 3998 | 0.38 | 100 | 1 |
| NCP18XH103D03RB | 10k ±0.5% | 3380 ±0.7% | 3428 | 3434 | 3455 | 0.31 | 100 | 1 |
| NCP18XH103F03RB | 10k ±1% | 3380 ±1% | 3428 | 3434 | 3455 | 0.31 | 100 | 1 |
| NCP18XH103□03RB | 10k | 3380 ±1% | 3428 | 3434 | 3455 | 0.31 | 100 | 1 |
| NCP18XV103□03RB | 10k | 3900 ±3% | 3930 | 3934 | 3944 | 0.31 | 100 | 1 |
| NCP18XW153□03RB | 15k | 3950 ±3% | 3982 | 3987 | 3998 | 0.25 | 100 | 1 |
| NCP18XW223□03RB | 22k | 3950 ±3% | 3982 | 3987 | 3998 | 0.21 | 100 | 1 |
| NCP18WB333□03RB | 33k | 4050 ±3% | 4101 | 4108 | 4131 | 0.17 | 100 | 1 |
| NCP18WB473D03RB | 47k ±0.5% | 4030 ±0.5% | 4101 | 4108 | 4131 | 0.14 | 100 | 1 |
| NCP18WB473F10RB | 47k ±1% | 4050 ±1.5% | 4101 | 4108 | 4131 | 0.14 | 100 | 1 |
| NCP18WB473□03RB | 47k | 4050 ±2% | 4101 | 4108 | 4131 | 0.14 | 100 | 1 |
| NCP18WD683□03RB | 68k | 4150 ±3% | 4201 | 4209 | 4232 | 0.12 | 100 | 1 |
| NCP18WF104D03RB | 100k ±0.5% | 4200 ±0.5% | 4255 | 4260 | 4282 | 0.10 | 100 | 1 |
| NCP18WF104F12RB | 100k ±1% | 4200 ±1% | 4255 | 4260 | 4282 | 0.10 | 100 | 1 |

Continued on the following page. ↗

⚠Note • Please read rating and ⚠CAUTION (for storage, operating, rating, soldering, mounting and handling) in this catalog to prevent smoking and/or burning, etc.
 • This catalog has only typical specifications. Therefore, please approve our product specifications or transact the approval sheet for product specifications before ordering.

Continued from the preceding page.

| Part Number | Resistance (25°C) (ohm) | B-Constant (25-50°C) (K) | B-Constant (25-80°C) (Reference Value) (K) | B-Constant (25-85°C) (Reference Value) (K) | B-Constant (25-100°C) (Reference Value) (K) | Permissible Operating Current (25°C) (mA) | Rated Electric Power (25°C) (mW) | Typical Dissipation Constant (25°C) (mW/°C) |
|------------------------|-------------------------|--------------------------|--|--|---|---|----------------------------------|---|
| NCP18WF104□03RB | 100k | 4250 ±2% | 4303 | 4311 | 4334 | 0.10 | 100 | 1 |
| NCP18WM154□03RB | 150k | 4500 ±3% | 4571 | 4582 | 4614 | 0.08 | 100 | 1 |
| NCP18WM224□03RB | 220k | 4500 ±3% | 4571 | 4582 | 4614 | 0.06 | 100 | 1 |
| NCP18WM474□03RB | 470k | 4500 ±3% | 4571 | 4582 | 4614 | 0.04 | 100 | 1 |

□ is filled with resistance tolerance codes (E: ±3%, J: ±5%).

Rated Electric Power shows the required electric power that the thermistor's temperature rise to 125°C by self-heating, at ambient temperature of 25 °C.

Operating Temperature Range: -40°C to +125°C

NTC Thermistors

Temperature Sensor and Compensation 0805 (2012) Size

Chip NTC Thermistors' Ni barrier termination provides excellent solderability and their unique construction offers high stability in the application's environment.

■ Features

1. Excellent solderability and high stability in the application's environment
2. Excellent long-term stability
3. High accuracy in resistance and B-constant
4. Flow / Reflow soldering possible
5. Same B-Constant in the same resistance in the three sizes (0805 size / 0603 size / 0402 size)
Downsize is easy for design.
6. NCP series are recognized by UL/cUL.
(UL1434, File No.E137188)

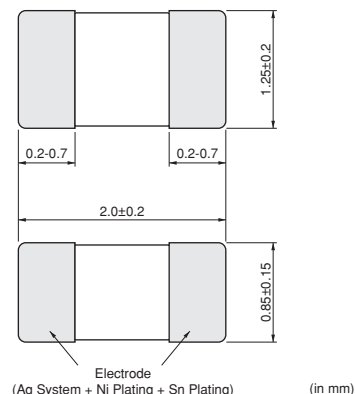
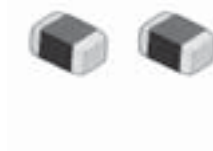

4

■ Applications

1. Temperature compensation for transistors, ICs, and crystal oscillators in mobile communications
2. Temperature sensor for rechargeable batteries
3. Temperature compensation of LCD
4. Temperature compensation in general use of electric circuits

| Part Number | Resistance (25°C) (ohm) | B-Constant (25-50°C) (K) | B-Constant (25-80°C) (Reference Value) (K) | B-Constant (25-85°C) (Reference Value) (K) | B-Constant (25-100°C) (Reference Value) (K) | Permissible Operating Current (25°C) (mA) | Rated Electric Power (25°C) (mW) | Typical Dissipation Constant (25°C) (mW/°C) |
|-----------------|-------------------------|--------------------------|--|--|---|---|----------------------------------|---|
| NCP21XM221J03RA | 220 ±5% | 3500 ±3% | 3539 | 3545 | 3560 | 3.00 | 200 | 2 |
| NCP21XQ471J03RA | 470 ±5% | 3650 ±3% | 3688 | 3693 | 3706 | 2.00 | 200 | 2 |
| NCP21XQ102J03RA | 1.0k ±5% | 3650 ±3% | 3688 | 3693 | 3706 | 1.40 | 200 | 2 |
| NCP21XW222J03RA | 2.2k ±5% | 3950 ±3% | 3982 | 3987 | 3998 | 0.90 | 200 | 2 |
| NCP21XM472J03RA | 4.7k ±5% | 3500 ±3% | 3539 | 3545 | 3560 | 0.65 | 200 | 2 |
| NCP21XV103J03RA | 10k ±5% | 3900 ±3% | 3930 | 3934 | 3944 | 0.44 | 200 | 2 |
| NCP21XW153J03RA | 15k ±5% | 3950 ±3% | 3982 | 3987 | 3998 | 0.36 | 200 | 2 |
| NCP21XW223J03RA | 22k ±5% | 3950 ±3% | 3982 | 3987 | 3998 | 0.30 | 200 | 2 |
| NCP21WB333J03RA | 33k ±5% | 4050 ±3% | 4101 | 4108 | 4131 | 0.24 | 200 | 2 |
| NCP21WB473J03RA | 47k ±5% | 4050 ±3% | 4101 | 4108 | 4131 | 0.20 | 200 | 2 |
| NCP21WF104J03RA | 100k ±5% | 4250 ±3% | 4303 | 4311 | 4334 | 0.14 | 200 | 2 |

Rated Electric Power shows the required electric power that the thermistor's temperature rise to 125°C by self-heating, at ambient temperature of 25 °C.
 Operating Temperature Range: -40°C to +125°C

Temperature Sensor and Compensation Chip Type Standard Land Pattern Dimensions



| Part Number | Soldering Methods | Dimensions (mm) | | | |
|--------------|-------------------|-----------------|---------|---------|---------|
| | | Chip (LxW) | a | b | c |
| NCP03 | Reflow Soldering | 0.6x0.3 | 0.25 | 0.3 | 0.3 |
| NCP15 | Reflow Soldering | 1.0x0.5 | 0.4 | 0.4-0.5 | 0.5 |
| NCP18 | Flow Soldering | 1.6x0.8 | 0.6-1.0 | 0.8-0.9 | 0.6-0.8 |
| | Reflow Soldering | | 0.6-0.8 | 0.6-0.7 | 0.6-0.8 |
| NCP21 | Flow Soldering | 2.0x1.25 | 1.0-1.1 | 0.9-1.0 | 1.0-1.2 |
| | Reflow Soldering | | 1.0-1.1 | 0.6-0.7 | 1.0-1.2 |

Temperature Sensor and Compensation Chip Type Temperature Characteristics (Center Value)

| Part Number | NCP15XC220 | NCP15XC330 | NCP15XC470 | NCP15XC680 | NCP□□XF101 | NCP□□XF151 | NCP□□XM221 | NCP□□XM331 |
|-------------|----------------|----------------|----------------|----------------|----------------|----------------|----------------|----------------|
| Resistance | 22Ω | 33Ω | 47Ω | 68Ω | 100Ω | 150Ω | 220Ω | 330Ω |
| B-Constant | 3100K | 3100K | 3100K | 3100K | 3250K | 3250K | 3500K | 3500K |
| Temp. (°C) | Resistance (Ω) | Resistance (Ω) | Resistance (Ω) | Resistance (Ω) | Resistance (Ω) | Resistance (Ω) | Resistance (Ω) | Resistance (Ω) |
| -40 | 355.823 | 533.734 | 760.166 | 1099.815 | 1824.175 | 2736.262 | 4947.904 | 7421.856 |
| -35 | 273.975 | 410.962 | 585.310 | 846.832 | 1390.685 | 2086.028 | 3703.755 | 5555.632 |
| -30 | 213.003 | 319.504 | 455.051 | 658.372 | 1070.653 | 1605.979 | 2798.873 | 4198.309 |
| -25 | 166.943 | 250.415 | 356.652 | 516.007 | 831.138 | 1246.708 | 2135.887 | 3203.831 |
| -20 | 131.997 | 197.996 | 281.994 | 407.991 | 650.960 | 976.440 | 1645.037 | 2467.555 |
| -15 | 105.318 | 157.978 | 224.998 | 325.529 | 514.441 | 771.661 | 1278.034 | 1917.051 |
| -10 | 84.670 | 127.005 | 180.886 | 261.707 | 409.700 | 614.550 | 1000.620 | 1500.930 |
| -5 | 68.628 | 102.942 | 146.614 | 212.123 | 328.877 | 493.315 | 789.612 | 1184.418 |
| 0 | 55.981 | 83.972 | 119.596 | 173.033 | 265.759 | 398.639 | 627.752 | 941.628 |
| 5 | 45.859 | 68.789 | 97.972 | 141.747 | 215.785 | 323.677 | 502.474 | 753.711 |
| 10 | 37.819 | 56.728 | 80.794 | 116.894 | 176.395 | 264.592 | 405.010 | 607.514 |
| 15 | 31.396 | 47.094 | 67.073 | 97.042 | 145.161 | 217.742 | 328.480 | 492.720 |
| 20 | 26.211 | 39.317 | 55.997 | 81.016 | 120.152 | 180.228 | 268.044 | 402.066 |
| 25 | 22.000 | 33.000 | 47.000 | 68.000 | 100.000 | 150.000 | 220.000 | 330.000 |
| 30 | 18.560 | 27.840 | 39.651 | 57.368 | 83.669 | 125.503 | 181.576 | 272.365 |
| 35 | 15.735 | 23.603 | 33.616 | 48.636 | 70.361 | 105.541 | 150.668 | 226.002 |
| 40 | 13.403 | 20.104 | 28.633 | 41.426 | 59.456 | 89.184 | 125.681 | 188.521 |
| 45 | 11.462 | 17.193 | 24.487 | 35.428 | 50.470 | 75.705 | 105.336 | 158.004 |
| 50 | 9.842 | 14.763 | 21.026 | 30.421 | 43.029 | 64.543 | 88.717 | 133.076 |
| 55 | 8.488 | 12.732 | 18.133 | 26.235 | 36.830 | 55.246 | 75.059 | 112.588 |
| 60 | 7.348 | 11.022 | 15.698 | 22.712 | 31.649 | 47.473 | 63.777 | 95.666 |
| 65 | 6.399 | 9.598 | 13.670 | 19.778 | 27.364 | 41.045 | 54.415 | 81.622 |
| 70 | 5.595 | 8.392 | 11.952 | 17.293 | 23.756 | 35.634 | 46.631 | 69.946 |
| 75 | 4.896 | 7.345 | 10.461 | 15.134 | 20.651 | 30.976 | 40.115 | 60.172 |
| 80 | 4.299 | 6.448 | 9.184 | 13.288 | 18.011 | 27.016 | 34.637 | 51.955 |
| 85 | 3.795 | 5.692 | 8.107 | 11.729 | 15.800 | 23.700 | 30.013 | 45.019 |
| 90 | 3.360 | 5.040 | 7.179 | 10.386 | 13.908 | 20.862 | 26.110 | 39.165 |
| 95 | 2.983 | 4.474 | 6.373 | 9.220 | 12.263 | 18.394 | 22.790 | 34.186 |
| 100 | 2.656 | 3.983 | 5.673 | 8.208 | 10.844 | 16.265 | 19.957 | 29.935 |
| 105 | 2.367 | 3.551 | 5.057 | 7.317 | 9.622 | 14.434 | 17.541 | 26.312 |
| 110 | 2.116 | 3.173 | 4.520 | 6.539 | 8.563 | 12.844 | 15.453 | 23.180 |
| 115 | 1.901 | 2.851 | 4.060 | 5.874 | 7.648 | 11.472 | 13.663 | 20.494 |
| 120 | 1.712 | 2.568 | 3.657 | 5.291 | 6.850 | 10.275 | 12.114 | 18.171 |
| 125 | 1.543 | 2.314 | 3.296 | 4.768 | 6.162 | 9.243 | 10.778 | 16.168 |

| Part Number | NCP□□XQ471 | NCP□□XQ681 | NCP□□XM102 | NCP□□XQ102 | NCP□□XM152 | NCP□□XW152 | NCP□□XM222 | NCP□□XW222 |
|-------------|----------------|----------------|-----------------|-----------------|-----------------|-----------------|-----------------|-----------------|
| Resistance | 470Ω | 680Ω | 1.0kΩ | 1.0kΩ | 1.5kΩ | 1.5kΩ | 2.2kΩ | 2.2kΩ |
| B-Constant | 3650K | 3650K | 3500K | 3650K | 3500K | 3950K | 3500K | 3950K |
| Temp. (°C) | Resistance (Ω) | Resistance (Ω) | Resistance (kΩ) | Resistance (kΩ) | Resistance (kΩ) | Resistance (kΩ) | Resistance (kΩ) | Resistance (kΩ) |
| -40 | 11822.473 | 17104.854 | 21.266 | 25.154 | 31.899 | 51.791 | 46.786 | 75.961 |
| -35 | 8767.745 | 12685.248 | 16.150 | 18.655 | 24.225 | 37.172 | 35.530 | 54.520 |
| -30 | 6570.224 | 9505.855 | 12.347 | 13.979 | 18.520 | 27.005 | 27.162 | 39.607 |
| -25 | 4971.784 | 7193.219 | 9.503 | 10.578 | 14.255 | 19.843 | 20.907 | 29.103 |
| -20 | 3796.933 | 5493.436 | 7.365 | 8.079 | 11.047 | 14.728 | 16.203 | 21.601 |
| -15 | 2923.400 | 4229.599 | 5.747 | 6.220 | 8.621 | 11.044 | 12.644 | 16.198 |
| -10 | 2269.599 | 3283.675 | 4.516 | 4.829 | 6.773 | 8.362 | 9.934 | 12.264 |
| -5 | 1775.225 | 2568.411 | 3.572 | 3.777 | 5.358 | 6.389 | 7.858 | 9.370 |
| 0 | 1399.050 | 2024.158 | 2.844 | 2.977 | 4.266 | 4.922 | 6.257 | 7.219 |
| 5 | 1110.220 | 1606.275 | 2.280 | 2.362 | 3.419 | 3.825 | 5.015 | 5.609 |
| 10 | 887.257 | 1283.691 | 1.839 | 1.888 | 2.758 | 2.994 | 4.045 | 4.391 |
| 15 | 713.463 | 1032.245 | 1.492 | 1.518 | 2.238 | 2.361 | 3.283 | 3.463 |
| 20 | 577.375 | 835.351 | 1.218 | 1.229 | 1.827 | 1.876 | 2.680 | 2.751 |
| 25 | 470.000 | 680.000 | 1.000 | 1.000 | 1.500 | 1.500 | 2.200 | 2.200 |
| 30 | 384.800 | 556.733 | 0.825 | 0.819 | 1.238 | 1.207 | 1.816 | 1.771 |
| 35 | 316.757 | 458.287 | 0.685 | 0.674 | 1.027 | 0.978 | 1.507 | 1.434 |
| 40 | 262.177 | 379.320 | 0.571 | 0.558 | 0.857 | 0.797 | 1.257 | 1.169 |
| 45 | 218.069 | 315.504 | 0.479 | 0.464 | 0.718 | 0.653 | 1.053 | 0.958 |
| 50 | 182.297 | 263.749 | 0.403 | 0.388 | 0.605 | 0.538 | 0.887 | 0.789 |
| 55 | 153.150 | 221.579 | 0.341 | 0.326 | 0.512 | 0.446 | 0.751 | 0.654 |
| 60 | 129.249 | 186.998 | 0.290 | 0.275 | 0.435 | 0.371 | 0.638 | 0.545 |
| 65 | 109.551 | 158.499 | 0.247 | 0.233 | 0.371 | 0.311 | 0.544 | 0.456 |
| 70 | 93.281 | 134.960 | 0.212 | 0.199 | 0.318 | 0.261 | 0.466 | 0.383 |
| 75 | 79.750 | 115.383 | 0.182 | 0.170 | 0.274 | 0.221 | 0.401 | 0.324 |
| 80 | 68.446 | 99.029 | 0.157 | 0.146 | 0.236 | 0.187 | 0.346 | 0.275 |
| 85 | 58.996 | 85.356 | 0.136 | 0.126 | 0.205 | 0.160 | 0.300 | 0.234 |
| 90 | 51.036 | 73.839 | 0.119 | 0.109 | 0.178 | 0.137 | 0.261 | 0.200 |
| 95 | 44.332 | 64.140 | 0.104 | 0.094 | 0.155 | 0.117 | 0.228 | 0.172 |
| 100 | 38.640 | 55.905 | 0.091 | 0.082 | 0.136 | 0.101 | 0.200 | 0.149 |
| 105 | 33.790 | 48.888 | 0.080 | 0.072 | 0.120 | 0.088 | 0.175 | 0.129 |
| 110 | 29.664 | 42.918 | 0.070 | 0.063 | 0.105 | 0.076 | 0.155 | 0.112 |
| 115 | 26.123 | 37.795 | 0.062 | 0.056 | 0.093 | 0.067 | 0.137 | 0.098 |
| 120 | 23.091 | 33.409 | 0.055 | 0.049 | 0.083 | 0.058 | 0.121 | 0.085 |
| 125 | 20.472 | 29.618 | 0.049 | 0.044 | 0.074 | 0.051 | 0.108 | 0.075 |

Detailed Resistance - Temperature Tables are downloadable from the following URL.
<http://search.murata.co.jp/Ceramy/CatsearchAction.do?sLang=en>

Continued on the following page.

Temperature Sensor and Compensation Chip Type Temperature Characteristics (Center Value)

Continued from the preceding page.

| Part Number | NCP□□XM332 | NCP□□XW332 | NCP□□XM472 | NCP□□XW472 | NCP□□XH682 | NCP□□XW682 | NCP□□XH103D | NCP□□XH103 |
|-------------|-----------------|-----------------|-----------------|-----------------|-----------------|-----------------|-----------------|-----------------|
| Resistance | 3.3kΩ | 3.3kΩ | 4.7kΩ | 4.7kΩ | 6.8kΩ | 6.8kΩ | 10kΩ±0.5% | 10kΩ |
| B-Constant | 3500K | 3950K | 3500K | 3950K | 3380K | 3950K | 3380K | 3380K |
| Temp. (°C) | Resistance (kΩ) | Resistance (kΩ) | Resistance (kΩ) | Resistance (kΩ) | Resistance (kΩ) | Resistance (kΩ) | Resistance (kΩ) | Resistance (kΩ) |
| -40 | 70.179 | 113.941 | 105.705 | 162.279 | 133.043 | 234.787 | 197.390 | 195.652 |
| -35 | 53.295 | 81.779 | 79.126 | 116.474 | 100.756 | 168.515 | 149.390 | 148.171 |
| -30 | 40.743 | 59.411 | 59.794 | 84.615 | 77.076 | 122.422 | 114.340 | 113.347 |
| -25 | 31.360 | 43.654 | 45.630 | 62.173 | 59.540 | 89.953 | 88.381 | 87.559 |
| -20 | 24.304 | 32.401 | 35.144 | 46.147 | 46.401 | 66.766 | 68.915 | 68.237 |
| -15 | 18.966 | 24.297 | 27.303 | 34.604 | 36.482 | 50.066 | 54.166 | 53.650 |
| -10 | 14.901 | 18.396 | 21.377 | 26.200 | 28.904 | 37.906 | 42.889 | 42.506 |
| -5 | 11.787 | 14.055 | 16.869 | 20.018 | 23.047 | 28.963 | 34.196 | 33.892 |
| 0 | 9.386 | 10.829 | 13.411 | 15.423 | 18.509 | 22.313 | 27.445 | 27.219 |
| 5 | 7.523 | 8.414 | 10.735 | 11.984 | 14.974 | 17.338 | 22.165 | 22.021 |
| 10 | 6.067 | 6.586 | 8.653 | 9.380 | 12.189 | 13.571 | 18.010 | 17.926 |
| 15 | 4.924 | 5.195 | 7.018 | 7.399 | 9.978 | 10.705 | 14.720 | 14.674 |
| 20 | 4.019 | 4.126 | 5.726 | 5.877 | 8.215 | 8.503 | 12.099 | 12.081 |
| 25 | 3.300 | 3.300 | 4.700 | 4.700 | 6.800 | 6.800 | 10.000 | 10.000 |
| 30 | 2.724 | 2.656 | 3.879 | 3.783 | 5.654 | 5.474 | 8.309 | 8.315 |
| 35 | 2.260 | 2.152 | 3.219 | 3.064 | 4.725 | 4.434 | 6.939 | 6.948 |
| 40 | 1.885 | 1.753 | 2.685 | 2.497 | 3.967 | 3.613 | 5.824 | 5.834 |
| 45 | 1.580 | 1.437 | 2.250 | 2.046 | 3.344 | 2.961 | 4.911 | 4.917 |
| 50 | 1.331 | 1.184 | 1.895 | 1.686 | 2.829 | 2.440 | 4.160 | 4.161 |
| 55 | 1.126 | 0.981 | 1.604 | 1.397 | 2.404 | 2.022 | 3.539 | 3.535 |
| 60 | 0.957 | 0.817 | 1.363 | 1.164 | 2.050 | 1.683 | 3.024 | 3.014 |
| 65 | 0.816 | 0.684 | 1.163 | 0.974 | 1.759 | 1.409 | 2.593 | 2.586 |
| 70 | 0.700 | 0.575 | 0.996 | 0.819 | 1.515 | 1.185 | 2.233 | 2.228 |
| 75 | 0.602 | 0.486 | 0.857 | 0.692 | 1.309 | 1.001 | 1.929 | 1.925 |
| 80 | 0.520 | 0.412 | 0.740 | 0.587 | 1.135 | 0.849 | 1.673 | 1.669 |
| 85 | 0.450 | 0.351 | 0.641 | 0.500 | 0.988 | 0.724 | 1.455 | 1.452 |
| 90 | 0.392 | 0.301 | 0.558 | 0.428 | 0.862 | 0.620 | 1.270 | 1.268 |
| 95 | 0.342 | 0.258 | 0.487 | 0.368 | 0.755 | 0.532 | 1.112 | 1.110 |
| 100 | 0.299 | 0.223 | 0.426 | 0.318 | 0.662 | 0.459 | 0.976 | 0.974 |
| 105 | 0.263 | 0.193 | 0.375 | 0.275 | 0.583 | 0.398 | 0.860 | 0.858 |
| 110 | 0.232 | 0.168 | 0.330 | 0.239 | 0.515 | 0.346 | 0.759 | 0.758 |
| 115 | 0.205 | 0.146 | 0.292 | 0.208 | 0.457 | 0.302 | 0.673 | 0.672 |
| 120 | 0.182 | 0.128 | 0.259 | 0.182 | 0.406 | 0.264 | 0.598 | 0.596 |
| 125 | 0.162 | 0.113 | 0.230 | 0.160 | 0.361 | 0.232 | 0.532 | 0.531 |

| Part Number | NCP□□XV103 | NCP□□XH153 | NCP□□XW153 | NCP□□XH223 | NCP□□XW223 | NCP□□WL223 | NCP□□WB333 | NCP□□WF333 |
|-------------|-----------------|-----------------|-----------------|-----------------|-----------------|-----------------|-----------------|-----------------|
| Resistance | 10kΩ | 15kΩ | 15kΩ | 22kΩ | 22kΩ | 22kΩ | 33kΩ | 33kΩ |
| B-Constant | 3900K | 3380K | 3950K | 3380K | 3950K | 4485K | 4050K | 4250K |
| Temp. (°C) | Resistance (kΩ) | Resistance (kΩ) | Resistance (kΩ) | Resistance (kΩ) | Resistance (kΩ) | Resistance (kΩ) | Resistance (kΩ) | Resistance (kΩ) |
| -40 | 328.996 | 293.478 | 517.912 | 430.434 | 759.605 | 1073.436 | 1227.263 | 1451.049 |
| -35 | 237.387 | 222.256 | 371.724 | 325.976 | 545.196 | 753.900 | 874.449 | 1019.238 |
| -30 | 173.185 | 170.021 | 270.048 | 249.364 | 396.070 | 535.073 | 630.851 | 725.084 |
| -25 | 127.773 | 131.338 | 198.426 | 192.629 | 291.025 | 383.590 | 460.457 | 522.021 |
| -20 | 95.327 | 102.355 | 147.278 | 150.121 | 216.008 | 277.643 | 339.797 | 379.842 |
| -15 | 71.746 | 80.474 | 110.439 | 118.029 | 161.977 | 202.813 | 253.363 | 279.371 |
| -10 | 54.564 | 63.759 | 83.617 | 93.514 | 122.638 | 149.462 | 190.766 | 207.566 |
| -5 | 41.813 | 50.838 | 63.888 | 74.563 | 93.702 | 111.082 | 144.964 | 155.639 |
| 0 | 32.330 | 40.828 | 49.221 | 59.881 | 72.191 | 83.233 | 111.087 | 117.814 |
| 5 | 25.194 | 33.032 | 38.245 | 48.446 | 56.093 | 62.858 | 85.842 | 89.925 |
| 10 | 19.785 | 26.888 | 29.936 | 39.436 | 43.907 | 47.831 | 66.861 | 69.204 |
| 15 | 15.651 | 22.010 | 23.613 | 32.282 | 34.633 | 36.664 | 52.470 | 53.675 |
| 20 | 12.468 | 18.121 | 18.756 | 26.577 | 27.509 | 28.304 | 41.471 | 41.937 |
| 25 | 10.000 | 15.000 | 15.000 | 22.000 | 22.000 | 22.000 | 33.000 | 33.000 |
| 30 | 8.072 | 12.472 | 12.074 | 18.292 | 17.709 | 17.214 | 26.430 | 26.143 |
| 35 | 6.556 | 10.422 | 9.780 | 15.285 | 14.344 | 13.557 | 21.298 | 20.845 |
| 40 | 5.356 | 8.751 | 7.969 | 12.834 | 11.688 | 10.744 | 17.266 | 16.723 |
| 45 | 4.401 | 7.375 | 6.531 | 10.817 | 9.578 | 8.566 | 14.076 | 13.498 |
| 50 | 3.635 | 6.241 | 5.382 | 9.154 | 7.894 | 6.871 | 11.538 | 10.954 |
| 55 | 3.019 | 5.302 | 4.459 | 7.777 | 6.540 | 5.544 | 9.506 | 8.940 |
| 60 | 2.521 | 4.521 | 3.713 | 6.631 | 5.446 | 4.498 | 7.870 | 7.334 |
| 65 | 2.115 | 3.879 | 3.108 | 5.690 | 4.559 | 3.669 | 6.549 | 6.046 |
| 70 | 1.781 | 3.341 | 2.613 | 4.901 | 3.832 | 3.009 | 5.475 | 5.011 |
| 75 | 1.509 | 2.887 | 2.208 | 4.234 | 3.239 | 2.479 | 4.595 | 4.170 |
| 80 | 1.284 | 2.503 | 1.873 | 3.671 | 2.748 | 2.052 | 3.874 | 3.487 |
| 85 | 1.097 | 2.178 | 1.597 | 3.195 | 2.342 | 1.707 | 3.282 | 2.928 |
| 90 | 0.941 | 1.902 | 1.367 | 2.790 | 2.004 | 1.426 | 2.789 | 2.469 |
| 95 | 0.810 | 1.664 | 1.174 | 2.441 | 1.722 | 1.196 | 2.379 | 2.091 |
| 100 | 0.701 | 1.461 | 1.013 | 2.142 | 1.486 | 1.008 | 2.038 | 1.777 |
| 105 | 0.608 | 1.287 | 0.878 | 1.888 | 1.287 | 0.852 | 1.751 | 1.516 |
| 110 | 0.530 | 1.137 | 0.763 | 1.668 | 1.119 | 0.724 | 1.509 | 1.298 |
| 115 | 0.463 | 1.007 | 0.665 | 1.477 | 0.975 | 0.617 | 1.306 | 1.116 |
| 120 | 0.406 | 0.895 | 0.582 | 1.312 | 0.854 | 0.528 | 1.134 | 0.962 |
| 125 | 0.358 | 0.797 | 0.511 | 1.169 | 0.750 | 0.454 | 0.987 | 0.832 |

Detailed Resistance - Temperature Tables are downloadable from the following URL.
<http://search.murata.co.jp/Ceramy/CatsearchAction.do?sLang=en>

Continued on the following page.

Temperature Sensor and Compensation Chip Type Temperature Characteristics (Center Value)

↳ Continued from the preceding page.

| Part Number | NCP□□WL333 | NCP15WB473D | NCP18WB473D | NCP□□WB473 | NCP□□WL473 | NCP□□WD683 | NCP□□WF683 | NCP□□WL683 |
|-------------|-----------------|-----------------|-----------------|-----------------|-----------------|-----------------|-----------------|-----------------|
| Resistance | 33kΩ | 47kΩ | 47kΩ | 47kΩ | 47kΩ | 68kΩ | 68kΩ | 68kΩ |
| B-Constant | 4485K | 4050K | 4030K | 4050K | 4485K | 4150K | 4250K | 4485K |
| Temp. (°C) | Resistance (kΩ) | Resistance (kΩ) | Resistance (kΩ) | Resistance (kΩ) | Resistance (kΩ) | Resistance (kΩ) | Resistance (kΩ) | Resistance (kΩ) |
| -40 | 1610.154 | 1690.586 | 1743.085 | 1747.920 | 2293.249 | 2735.359 | 2990.041 | 3317.893 |
| -35 | 1130.850 | 1215.318 | 1241.814 | 1245.428 | 1610.605 | 1937.391 | 2100.247 | 2330.237 |
| -30 | 802.609 | 882.908 | 896.201 | 898.485 | 1143.110 | 1389.345 | 1494.113 | 1653.862 |
| -25 | 575.385 | 647.911 | 654.460 | 655.802 | 819.487 | 1008.014 | 1075.679 | 1185.641 |
| -20 | 416.464 | 480.069 | 483.172 | 483.954 | 593.146 | 738.978 | 782.705 | 858.168 |
| -15 | 304.219 | 359.009 | 360.367 | 360.850 | 433.281 | 547.456 | 575.674 | 626.875 |
| -10 | 224.193 | 270.868 | 271.363 | 271.697 | 319.305 | 409.600 | 427.712 | 461.974 |
| -5 | 166.623 | 206.113 | 206.204 | 206.463 | 237.312 | 309.217 | 320.710 | 343.345 |
| 0 | 124.850 | 158.126 | 158.051 | 158.214 | 177.816 | 235.606 | 242.768 | 257.266 |
| 5 | 94.287 | 122.267 | 122.145 | 122.259 | 134.287 | 180.980 | 185.300 | 194.287 |
| 10 | 71.747 | 95.256 | 95.145 | 95.227 | 102.184 | 140.139 | 142.603 | 147.841 |
| 15 | 54.996 | 74.754 | 74.676 | 74.730 | 78.327 | 109.344 | 110.602 | 113.325 |
| 20 | 42.455 | 59.075 | 59.038 | 59.065 | 60.467 | 85.929 | 86.415 | 87.484 |
| 25 | 33.000 | 47.000 | 47.000 | 47.000 | 47.000 | 68.000 | 68.000 | 68.000 |
| 30 | 25.822 | 37.636 | 37.667 | 37.643 | 36.776 | 54.167 | 53.871 | 53.208 |
| 35 | 20.335 | 30.326 | 30.381 | 30.334 | 28.962 | 43.421 | 42.954 | 41.903 |
| 40 | 16.115 | 24.583 | 24.654 | 24.591 | 22.952 | 35.016 | 34.460 | 33.208 |
| 45 | 12.849 | 20.043 | 20.124 | 20.048 | 18.301 | 28.406 | 27.814 | 26.477 |
| 50 | 10.306 | 16.433 | 16.518 | 16.433 | 14.679 | 23.166 | 22.572 | 21.237 |
| 55 | 8.317 | 13.545 | 13.631 | 13.539 | 11.845 | 18.997 | 18.422 | 17.137 |
| 60 | 6.748 | 11.223 | 11.306 | 11.209 | 9.610 | 15.657 | 15.113 | 13.904 |
| 65 | 5.504 | 9.345 | 9.424 | 9.328 | 7.839 | 12.967 | 12.459 | 11.342 |
| 70 | 4.513 | 7.818 | 7.892 | 7.798 | 6.427 | 10.794 | 10.325 | 9.299 |
| 75 | 3.718 | 6.571 | 6.639 | 6.544 | 5.296 | 9.021 | 8.592 | 7.662 |
| 80 | 3.078 | 5.548 | 5.609 | 5.518 | 4.384 | 7.575 | 7.185 | 6.343 |
| 85 | 2.560 | 4.704 | 4.759 | 4.674 | 3.646 | 6.387 | 6.033 | 5.276 |
| 90 | 2.139 | 4.004 | 4.054 | 3.972 | 3.046 | 5.407 | 5.087 | 4.407 |
| 95 | 1.794 | 3.422 | 3.468 | 3.388 | 2.555 | 4.598 | 4.309 | 3.697 |
| 100 | 1.511 | 2.936 | 2.977 | 2.902 | 2.152 | 3.922 | 3.661 | 3.114 |
| 105 | 1.278 | 2.528 | 2.566 | 2.494 | 1.820 | 3.359 | 3.124 | 2.634 |
| 110 | 1.085 | 2.184 | 2.220 | 2.150 | 1.546 | 2.887 | 2.675 | 2.236 |
| 115 | 0.925 | 1.893 | 1.927 | 1.860 | 1.318 | 2.489 | 2.299 | 1.907 |
| 120 | 0.792 | 1.646 | 1.679 | 1.615 | 1.128 | 2.155 | 1.983 | 1.632 |
| 125 | 0.681 | 1.436 | 1.468 | 1.406 | 0.970 | 1.870 | 1.715 | 1.403 |

| Part Number | NCP15WF104D | NCP18WF104D/F | NCP□□WF104 | NCP□□WL104 | NCP□□WL154 | NCP□□WM154 | NCP□□WL224 | NCP□□WM224 |
|-------------|-----------------|-----------------|-----------------|-----------------|-----------------|-----------------|-----------------|-----------------|
| Resistance | 100kΩ±0.5% | 100kΩ±1% | 100kΩ | 100kΩ | 150kΩ | 150kΩ | 220kΩ | 220kΩ |
| B-Constant | 4250K | 4200K | 4250K | 4485K | 4485K | 4500K | 4485K | 4500K |
| Temp. (°C) | Resistance (kΩ) | Resistance (kΩ) | Resistance (kΩ) | Resistance (kΩ) | Resistance (kΩ) | Resistance (kΩ) | Resistance (kΩ) | Resistance (kΩ) |
| -40 | 4221.283 | 4205.686 | 4397.119 | 4879.254 | 7318.881 | 7899.466 | 10734.358 | 11585.884 |
| -35 | 2995.044 | 2966.436 | 3088.599 | 3426.818 | 5140.228 | 5466.118 | 7539.001 | 8016.973 |
| -30 | 2146.996 | 2118.789 | 2197.225 | 2432.149 | 3648.224 | 3834.499 | 5350.729 | 5623.931 |
| -25 | 1554.599 | 1531.319 | 1581.881 | 1743.590 | 2615.385 | 2720.523 | 3835.898 | 3990.100 |
| -20 | 1136.690 | 1118.422 | 1151.037 | 1262.012 | 1893.018 | 1951.216 | 2776.427 | 2861.784 |
| -15 | 839.019 | 825.570 | 846.579 | 921.875 | 1382.813 | 1415.565 | 2028.126 | 2076.162 |
| -10 | 624.987 | 615.526 | 628.988 | 679.373 | 1019.059 | 1036.984 | 1494.620 | 1520.909 |
| -5 | 469.678 | 463.104 | 471.632 | 504.919 | 757.379 | 767.079 | 1110.822 | 1125.049 |
| 0 | 355.975 | 351.706 | 357.012 | 378.333 | 567.499 | 572.667 | 832.332 | 839.912 |
| 5 | 272.011 | 269.305 | 272.500 | 285.717 | 428.575 | 431.264 | 628.577 | 632.521 |
| 10 | 209.489 | 207.891 | 209.710 | 217.414 | 326.121 | 327.405 | 478.310 | 480.194 |
| 15 | 162.559 | 161.722 | 162.651 | 166.654 | 249.981 | 250.538 | 366.639 | 367.455 |
| 20 | 127.057 | 126.723 | 127.080 | 128.653 | 192.979 | 193.166 | 283.036 | 283.310 |
| 25 | 100.000 | 100.000 | 100.000 | 100.000 | 150.000 | 150.000 | 220.000 | 220.000 |
| 30 | 79.222 | 79.439 | 79.222 | 78.247 | 117.370 | 117.281 | 172.143 | 172.012 |
| 35 | 63.167 | 63.509 | 63.167 | 61.622 | 92.433 | 92.293 | 135.569 | 135.364 |
| 40 | 50.677 | 51.084 | 50.677 | 48.835 | 73.252 | 73.090 | 107.436 | 107.198 |
| 45 | 40.904 | 41.336 | 40.904 | 38.937 | 58.406 | 58.240 | 85.662 | 85.419 |
| 50 | 33.195 | 33.628 | 33.195 | 31.231 | 46.846 | 46.665 | 68.708 | 68.441 |
| 55 | 27.091 | 27.510 | 27.091 | 25.202 | 37.803 | 37.605 | 55.444 | 55.153 |
| 60 | 22.224 | 22.621 | 22.224 | 20.448 | 30.671 | 30.453 | 44.984 | 44.665 |
| 65 | 18.323 | 18.692 | 18.323 | 16.679 | 25.018 | 24.804 | 36.694 | 36.379 |
| 70 | 15.184 | 15.525 | 15.184 | 13.675 | 20.513 | 20.293 | 30.085 | 29.763 |
| 75 | 12.635 | 12.947 | 12.635 | 11.268 | 16.902 | 16.679 | 24.789 | 24.462 |
| 80 | 10.566 | 10.849 | 10.566 | 9.329 | 13.993 | 13.776 | 20.523 | 20.205 |
| 85 | 8.873 | 9.129 | 8.873 | 7.758 | 11.638 | 11.428 | 17.068 | 16.761 |
| 90 | 7.481 | 7.713 | 7.481 | 6.481 | 9.721 | 9.520 | 14.258 | 13.962 |
| 95 | 6.337 | 6.546 | 6.337 | 5.437 | 8.155 | 7.966 | 11.961 | 11.684 |
| 100 | 5.384 | 5.572 | 5.384 | 4.580 | 6.869 | 6.688 | 10.075 | 9.809 |
| 105 | 4.594 | 4.764 | 4.594 | 3.873 | 5.810 | 5.639 | 8.521 | 8.270 |
| 110 | 3.934 | 4.087 | 3.934 | 3.289 | 4.933 | 4.772 | 7.236 | 6.998 |
| 115 | 3.380 | 3.518 | 3.380 | 2.804 | 4.206 | 4.052 | 6.169 | 5.942 |
| 120 | 2.916 | 3.040 | 2.916 | 2.400 | 3.601 | 3.454 | 5.281 | 5.067 |
| 125 | 2.522 | 2.634 | 2.522 | 2.064 | 3.096 | 2.955 | 4.540 | 4.334 |

Detailed Resistance - Temperature Tables are downloadable from the following URL.
<http://search.murata.co.jp/Ceramy/CatsearchAction.do?sLang=en>

Continued on the following page. ↗

Temperature Sensor and Compensation Chip Type Temperature Characteristics (Center Value)

↳ Continued from the preceding page.

| Part Number | NCP□□WM474 |
|-------------|-----------------|
| Resistance | 470kΩ |
| B-Constant | 4500K |
| Temp. (°C) | Resistance (kΩ) |
| -40 | 24751.661 |
| -35 | 17127.169 |
| -30 | 12014.762 |
| -25 | 8524.305 |
| -20 | 6113.811 |
| -15 | 4435.437 |
| -10 | 3249.216 |
| -5 | 2403.515 |
| 0 | 1794.358 |
| 5 | 1351.294 |
| 10 | 1025.870 |
| 15 | 785.018 |
| 20 | 605.252 |
| 25 | 470.000 |
| 30 | 367.480 |
| 35 | 289.186 |
| 40 | 229.014 |
| 45 | 182.485 |
| 50 | 146.215 |
| 55 | 117.828 |
| 60 | 95.420 |
| 65 | 77.718 |
| 70 | 63.584 |
| 75 | 52.260 |
| 80 | 43.166 |
| 85 | 35.808 |
| 90 | 29.828 |
| 95 | 24.961 |
| 100 | 20.955 |
| 105 | 17.668 |
| 110 | 14.951 |
| 115 | 12.695 |
| 120 | 10.824 |
| 125 | 9.259 |

Detailed Resistance - Temperature Tables are downloadable from the following URL.
<http://search.murata.co.jp/Ceramy/CatsearchAction.do?sLang=en>

Temperature Sensor and Compensation Chip Type ⚠Caution/Notice

■ ⚠Caution (Storage and Operating Conditions)

This product is designed for application in an ordinary environment (normal room temperature, humidity and atmospheric pressure).

Do not use under the following conditions because all of these factors can deteriorate the product characteristics or cause failures and burn-out.

1. Corrosive gas or deoxidizing gas

(Chlorine gas, Hydrogen sulfide gas, Ammonia gas, Sulfuric acid gas, Nitric oxide gas, etc.)

2. Volatile or flammable gas

3. Dusty conditions

4. Under vacuum, or under high or low pressure

5. Wet or humid locations

6. Places with salt water, oils, chemical liquids or organic solvents

7. Strong vibrations

8. Other places where similar hazardous conditions exist

■ ⚠Caution (Others)

Be sure to provide an appropriate fail-safe function on your product to prevent secondary damage that may be caused by the abnormal function or the failure of our product.

■ Notice (Storage and Operating Conditions)

To keep the solderability of the product from degrading, the following storage conditions are recommended.

1. Storage condition:

Temperature -10 to +40°C

Humidity less than 75%RH (not dewing condition)

2. Storage term:

Use this product within 6 months after delivery by first-in and first-out stocking system.

3. Storage place:

Do not store this product in corrosive gas (Sulfuric acid gas, Chlorine gas, etc.) or in direct sunlight.

■ Notice (Rating)

Use this product within the specified temperature range.

Higher temperature may cause deterioration of the characteristics or the material quality of this product.

■ Notice (Handling)

The ceramic of this product is fragile, and care must be taken not to load an excessive press-force or to cause a shock at handling.

Such forces may cause cracking or chipping.

Temperature Sensor and Compensation Chip Type ⚠Caution/Notice

■ Notice (Soldering and Mounting)

1. Mounting Position

Choose a mounting position that minimizes the stress imposed on the chip during flexing or bending of the board.



2. Allowable Soldering Temperature and Time

- (a) Solder within the temperature and time combinations indicated by the slanted lines in the following graphs.
- (b) Excessive soldering conditions may cause dissolution of metallization or deterioration of solder-wetting on the external electrode.
- (c) In case of repeated soldering, the accumulated soldering time should be within the range shown in the figure below. (For example, Reflow peak temperature: 260°C, twice -> The total accumulated soldering time at 260°C is within 30 seconds.)



Continued on the following page.

Temperature Sensor and Compensation Chip Type ⚠Caution/Notice

☐ Continued from the preceding page.

3. Recommended Temperature Profile for Soldering

- (a) Insufficient preheating may cause a crack on the ceramic body. The difference between preheating temperature and maximum temperature in the profile shall be 100 °C.
 (b) Rapid cooling by dipping in solvent or by other means is not recommended.

* In case of repeated soldering, the accumulated soldering time should be within the range shown in the figure of section 2.

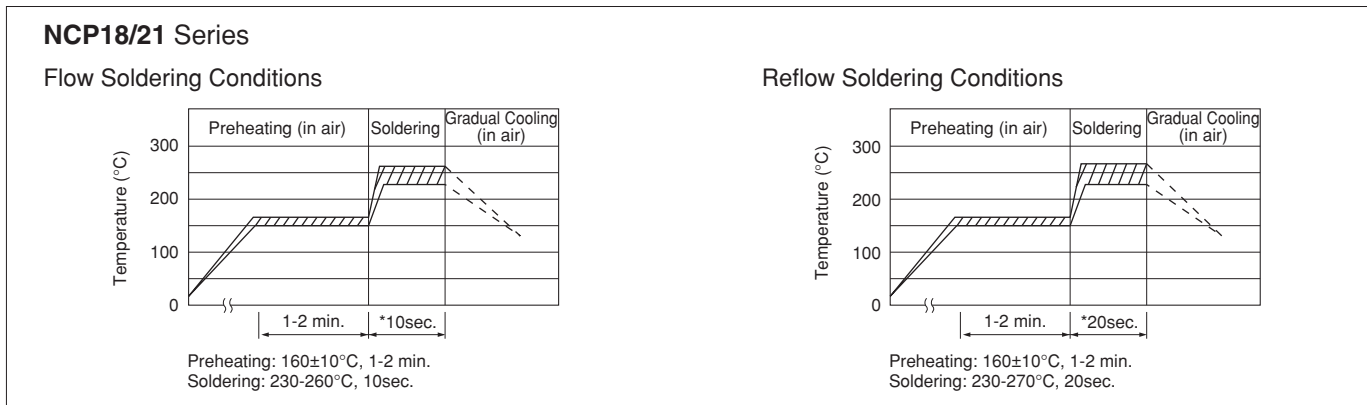
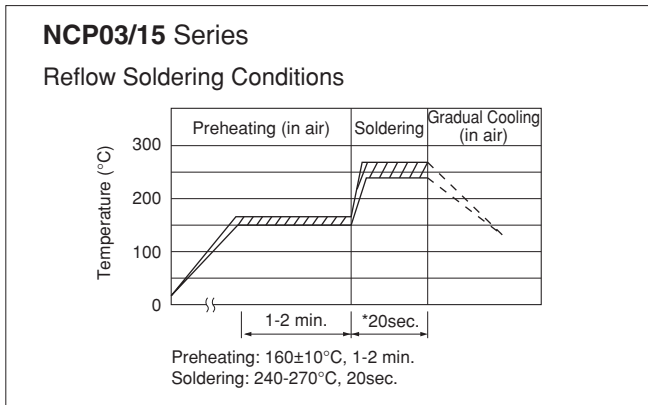

4. Solder and Flux

(1) Solder and Paste

(a) Reflow Soldering: NCP03/15/18/21 Series

Use RA/RMA type or equivalent type of solder paste. For your reference, we use the solder paste below for any internal tests of this product.

- RMA9086 90-4-M20 (Sn:Pb=63wt%:37wt%)
 (Manufactured by Alpha Metals Japan Ltd.)
- M705-221BM5-42-11 (Sn:Ag:Cu=96.5wt%:3.0wt%:0.5wt%)
 (Manufactured by Senju Metal Industry Co., Ltd.)

(b) Flow Soldering: NCP18/21 Series

We use the solder paste below for any internal tests of this product.

- Sn:Pb=63wt%:37wt%
- Sn:Ag:Cu=96.5wt%:3.0wt%:0.5wt%

(2) Flux

Use rosin type flux in the soldering process.

If the flux listed below is used, some problems might be caused in the product characteristics and reliability.

Please do not use the following flux.

- Strong acidic flux (with halide content exceeding 0.1wt%).
- Water-soluble flux
 (*Water-soluble flux can be defined as non-rosin type flux including wash-type flux and non-wash-type flux.)

5. Cleaning Conditions

For removing the flux after soldering, observe the following points in order to avoid deterioration of the characteristics or any change of the external electrodes' quality.

- Please keep mounted parts and a substrate from an occurrence of resonance in ultrasonic cleaning.
- Please do not clean the products in the case of using a non-wash-type flux.

| | NCP03/15 | NCP18/21 |
|---------------------|---|---|
| Solvent | Isopropyl Alcohol | Isopropyl Alcohol |
| Dipping Cleaning | Less than 5 minutes at room temp. or less than 2 minutes at 40°C max. | Less than 5 minutes at room temp. or less than 2 minutes at 40°C max. |
| Ultrasonic Cleaning | Less than 5 minutes and 20W/ℓ Frequency of 28kHz to 40kHz | Less than 1 minute and 20W/ℓ Frequency of several 10kHz to 100kHz |

6. Drying

After cleaning, promptly dry this product.

Temperature Sensor and Compensation Chip Type ⚠Caution/Notice

☐ Continued from the preceding page.

7. Printing Conditions of Solder Paste

- The amount of solder is critical. Standard height of fillet is shown in the table below.
- Too much solder may cause mechanical stress, resulting in cracking, mechanical and/or electronic damage.



| Part Number | Solder Paste Thickness | T |
|-------------|------------------------|------------------------------|
| NCP03 | 100μm | $1/3E \leq T \leq E$ |
| NCP15 | 150μm | $1/3E \leq T \leq E$ |
| NCP18/NCP21 | 200μm | $0.2\text{mm} \leq T \leq E$ |

8. Adhesive Application and Curing

- Thin or insufficient adhesive may result in loose component contact with land during flow soldering.
- Low viscosity adhesive causes chips to slip after mounting.

Temperature Sensor and Compensation Chip Type Package

■ Minimum Quantity Guide

| Part Number | Quantity (pcs.) | |
|-------------|-----------------|---------------|
| | Paper Tape | Embossed Tape |
| NCP03 | 15,000 | - |
| NCP15 | 10,000 | |
| NCP18 | 4,000 | |
| NCP21 | - | 4,000 |

■ Tape Carrier Packaging

1. Dimensions of Reel



2. Taping Method

- (1) A tape in a reel contains Leader unit and Trailer unit where products are not packed. (Please refer to the figure at the right.)
- (2) The top and base tapes or plastic and cover tape are not stuck at the first five pitches minimum.
- (3) A label should be attached on the reel. (MURATA's part number, inspection number and quantity should be marked on the label.)
- (4) Taping reels are packed in a package.



Continued on the following page.

Temperature Sensor and Compensation Chip Type Package

☞ Continued from the preceding page.

3. Paper Tape (NCP03/15/18 Series)



(1) Other Conditions

(a) Packaging

Products are packaged in the cavity of the base tape and sealed by a top tape and bottom tape.

(b) Tape

The top tape and bottom tape have no joints and products are packaged and sealed in the cavity of the base tape, continuously.

(2) Peeling Force of Top Tape



(3) Pull Strength

Pull strength of top tape is specified at 10N minimum.

Pull strength of bottom tape should be specified 5N minimum.

Continued on the following page. ☞

Temperature Sensor and Compensation Chip Type Package

☐ Continued from the preceding page.

4. Embossed Tape (NCP21 Series)

(1) Other Conditions

(a) Packaging

Products are packaged in the each cavity of Embossed tape and sealed by Cover tape.

(b) Tape

Cover tape has no joints.



(2) Peeling Force of Cover Tape



(3) Tape Strength

Pull strength of Embossed tape and Cover tape should be specified 10N minimum.

NTC Thermistors

Temperature Sensor Thermo String Type

This product is a small flexible lead type NTC Thermistor with a small head and a thin lead wire.

■ Features

1. This small and highly accurate NTC Thermistor provides extremely precise temperature sensing.
2. The small sensing head and thin lead wire deliver temperature sensing in a narrow space.
3. Flexibility and a wide variety of lengths (25mm to 150mm) enable the design of flexible temperature sensing architectures.
4. This product is compatible with our 0402 (EIA) size chip Thermistor.
5. Excellent long-term stability
6. This is a halogen free product. *
 * Cl= max.900ppm, Br=max.900ppm and
 Cl+Br=max.1500ppm
7. NXFT series are recognized by UL/cUL.
 (UL1434, File No.E137188).

■ Applications

1. Temperature compensation for transistors, ICs, and crystal oscillators in mobile communications
2. Temperature sensor for rechargeable batteries
3. Temperature compensation of LCD
4. Temperature compensation in general use of electric circuits

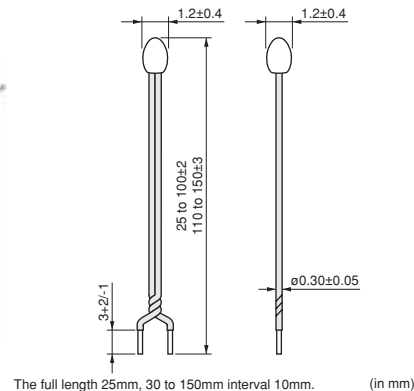

NXFT15_1B Type (twist)



NXFT15_2B Type (without twist)

| Part Number | Resistance (25°C) (ohm) | B-Constant (25-50°C) (K) | B-Constant (25-80°C) (Reference Value) (K) | B-Constant (25-85°C) (Reference Value) (K) | B-Constant (25-100°C) (Reference Value) (K) | Operating Current for Sensor (25°C) (mA) | Rated Electric Power (25°C) (mW) | Typical Dissipation Constant (25°C) (mW/°C) | Thermal Time Constant (25°C) (s) |
|--------------------|-------------------------|--------------------------|--|--|---|--|----------------------------------|---|----------------------------------|
| NXFT15XH103FA□B□□□ | 10k ±1% | 3380 ±1% | 3428 | 3434 | 3455 | 0.12 | 7.5 | 1.5 | 4 |
| NXFT15XV103FA□B□□□ | 10k ±1% | 3936 ±1% | 3971 | 3977 | 3988 | 0.12 | 7.5 | 1.5 | 4 |
| NXFT15WB473FA□B□□□ | 47k ±1% | 4050 ±1% | 4101 | 4108 | 4131 | 0.06 | 7.5 | 1.5 | 4 |
| NXFT15WF104FA□B□□□ | 100k ±1% | 4250 ±1% | 4303 | 4311 | 4334 | 0.04 | 7.5 | 1.5 | 4 |

□ is filled with lead shape (1: twist, 2: without twist).

□□□ is filled with Total-length codes. (25mm, 30 to 150mm interval 10mm, ex. 050=50mm)

Operating Current for Sensor rises Thermistor's temperature by 0.1°C

Rated Electric Power shows the required electric power that the thermistor's temperature rise to 30°C by self-heating, at ambient temperature of 25 °C.

Operating Temperature Range: -40°C to +125°C

Temperature Sensor Thermo String Type Specifications and Test Methods

| No. | Item | Specifications | Test Methods |
|-----|---------------------------------|---|---|
| 1 | High Temperature Storage Test | · Resistance (R25°C) fluctuation rate: less than ±1%. · B-Constant (B25/50°C) fluctuation rate: less than ±1%. | 125±2°C in air, for 1000 +48/-0 hours without loading. |
| 2 | Low Temperature Storage Test | | -40 +0/-3°C in air, for 1000 +48/-0 hours without loading. |
| 3 | Humidity Storage Test | | 60±2°C, 90 to 95%RH in air, for 1000 +48/-0 hours without loading. |
| 4 | Temperature Cycle | · Resistance (R25°C) fluctuation rate: less than ±2%. · B-Constant (B25/50°C) fluctuation rate: less than ±1%. | -40 +0/-3°C, 30 minutes in air +25±2°C, 10 to 15 minutes in air +125±2°C, 30 minutes in air +25 +2/-0°C, 10 to 15 minutes in air (1 cycle) Continuous 100 cycles, without loading. |
| 5 | High Temperature Load | | 85±2°C in air, with 'Operating Current for Sensor' for 1000 +48/-0 hrs. |
| 6 | Insulation Break - down Voltage | · No damage electrical characteristics at DC100 V, 1 min. | 2mm length of coating resin from the top of Thermistor is to be dipped into beads of lead (Pb), and DC100V 1 minute is applied to circuit between beads of lead (Pb) and lead wire. |
| 7 | Resistance to Soldering Heat | · Resistance (R25°C) fluctuation rate: less than ±1%. · B-Constant (B25/50°C) fluctuation rate: less than ±1%. | Both lead wires are dipped into 350±10°C solder for 3.5±0.5 seconds, or 260±5°C solder for 10±1 seconds according to Fig-1 (solder <JIS Z 3282 SnAgCu>).  Fig-1 |
| 8 | Solderability | More than 90% of lead wire surface shall be covered by solder. | Both lead wires are dipped into flux (25wt% colophony <JIS K 5902> isopropyl alcohol <JIS K 8839>) for 5 to 10 seconds. Then both lead wires are dipped into 245±5°C solder <JIS Z 3282 SnAgCu> for 2±0.5 seconds according to Fig-1. |
| 9 | Lead Wire Pull Strength | · Resistance (R25°C) fluctuation rate: less than ±1%. · B-Constant (B25/50°C) fluctuation rate: less than ±1%. | The lead wire shall be inserted in a ø1.0mm hole until resin part contacts with a substrate as shown in fig.-2, and 1N force for 10 seconds shall be applied to the lead wire.  Fig-2 |
| 10 | Lead Wire Bending Strength | · Lead wire does not break. | Hold the lead wires as in Fig-3. Bend by 90 degrees and again bend back to the initial position. Then bend to the other side by 90 degrees and again bend back to the initial position. After bending process, 10N force for 3 seconds shall be applied to the lead wire.  Fig-3 |

* · R25 is zero-power resistance at 25°C.
 · B25/50 is calculated by zero-power resistance of Thermistor in 25°C-50°C.
 · After each test, NTC Thermistor should be kept for 1 hour at room temperature (normal humidity and normal atmospheric pressure).

Temperature Sensor Thermo String Type Specifications and Test Methods

☞ Continued from the preceding page.

| No. | Item | Specifications | Test Methods |
|-----|-----------|---|--|
| 11 | Free Fall | | NTC Thermistor shall be dropped without any force onto concrete floor from 1 meter height one time. |
| 12 | Vibration | <ul style="list-style-type: none"> · Resistance (R25°C) fluctuation rate: less than ±1%. · B-Constant (B25/50°C) fluctuation rate: less than ±1%. · No visible damage at resin part. | <p>NTC Thermistor shall be fixed to the vibration test equipment. Vibration of total 1.5 mm amplitude, Frequency sequence of 10Hz - 55Hz - 10Hz in 1 minute shall be applied for right angled 3 directions for 2 hours duration each.</p>  |

- * · R25 is zero-power resistance at 25°C.
- B25/50 is calculated by zero-power resistance of Thermistor in 25°C-50°C.
- After each test, NTC Thermistor should be kept for 1 hour at room temperature (normal humidity and normal atmospheric pressure).

NTC Thermistors

Temperature Sensor Lead Type

This thermistor is for normal temperature level sensors having self-subsistence due to strong lead strength based on chip NTC.

■ Features

1. This highly accurate NTC Thermistor provides extremely precise temperature sensing.
2. This product is compatible with 1005 (1.0mm x 0.5mm) size NTC Thermistor.
3. The variation per hour of this product is highly stable.
4. This product is produced with an automation line that was consistent from lead to packaging so that a product of uniform quality may be obtained at low cost in large quantities.
5. Since this product has strong lead intensity with original lead mounting technique, it is bent at the time of use and can withstand processing, etc., readily.
Taping package can be supported.



■ Applications

1. For temperature detection of a rechargeable battery pack
2. For temperature detection of a charge circuit
3. For temperature detection of a printer head
4. For temperature detection of a DC fan motor
5. For temperature detection of home electronics

6

| Part Number | Resistance (25°C) (ohm) | B-Constant (25-50°C) (K) | B-Constant (25-80°C) (Reference Value) (K) | B-Constant (25-85°C) (Reference Value) (K) | B-Constant (25-100°C) (Reference Value) (K) | Operating Current for Sensor (25°C) (mA) | Rated Electric Power (25°C) (mW) | Typical Dissipation Constant (25°C) (mW/°C) | Thermal Time Constant (25°C) (s) |
|---------------------|-------------------------|--------------------------|--|--|---|--|----------------------------------|---|----------------------------------|
| NXRT15XM202EA1B□□□□ | 2k ±3% | 3500 ±1% | 3539 | 3545 | 3560 | 0.27 | 7.5 | 1.5 | 4 |
| NXRT15XV502FA1B□□□□ | 5k ±1% | 3936 ±1% | 3972 | 3977 | 3989 | 0.17 | 7.5 | 1.5 | 4 |
| NXRT15XH103FA1B□□□□ | 10k ±1% | 3380 ±1% | 3428 | 3434 | 3455 | 0.12 | 7.5 | 1.5 | 4 |
| NXRT15XV103FA1B□□□□ | 10k ±1% | 3936 ±1% | 3971 | 3977 | 3988 | 0.12 | 7.5 | 1.5 | 4 |
| NXRT15WB333JA1B□□□□ | 33k ±5% | 4050 ±3% | 4101 | 4108 | 4131 | 0.07 | 7.5 | 1.5 | 4 |
| NXRT15WB473FA1B□□□□ | 47k ±1% | 4050 ±1% | 4101 | 4108 | 4131 | 0.06 | 7.5 | 1.5 | 4 |
| NXRT15WF104FA1B□□□□ | 100k ±1% | 4250 ±1% | 4303 | 4311 | 4334 | 0.04 | 7.5 | 1.5 | 4 |

□□□□ is filled with Total-length codes. (10 to 40mm interval 10mm, ex. 040=40mm)

Operating Current for Sensor rises Thermistor's temperature by 0.1°C.

Rated Electric Power is necessary electric power that thermistor's temperature rises 5°C by self-heating at 25°C in still air.

Taping type of part numbers with "3A016" is available (Lead Spacing=5mm).

Operating Temperature Range: -40°C to +125°C

Temperature Sensor Lead Type Specifications and Test Methods

| No. | Item | Specifications | Test Methods |
|-----|---------------------------------|---|---|
| 1 | Low Temperature Storage Test | <ul style="list-style-type: none"> · Resistance (R25°C) fluctuation rate: less than ±1%. · B-Constant (B25/50°C) fluctuation rate: less than ±1%. | -40 +0/-3°C in air, for 1000 +48/-0 hours without loading. |
| 2 | High Temperature Storage Test | | 125±2°C in air, for 1000 +48/-0 hours without loading. |
| 3 | High Temperature Load | <ul style="list-style-type: none"> · Resistance (R25°C) fluctuation rate: less than ±2%. · B-Constant (B25/50°C) fluctuation rate: less than ±1%. | 85±2°C in air, with 'Operating Current for Sensor' for 1000 +48/-0 hrs. |
| 4 | Humidity Storage Test | | 60±2°C, 90 to 95%RH in air, for 1000 +48/-0 hours without loading. |
| 5 | Temperature Cycle | | -40°C +0/-3°C, 30 minutes in air +25°C±2°C, 10 to 15 minutes in air +125°C +3/-0°C, 30 minutes in air +25°C +2/-0°C, 10 to 15 minutes in air (1 cycle) Continuous 100 cycles, without loading. |
| 6 | Insulation Break - down Voltage | <ul style="list-style-type: none"> · No damage electrical characteristics on D.C.100 V, 1 min. | 2mm length of coating resin from the top of thermistor is to be dipped into beads of lead (Pb), and DC100V 1 minute is applied to circuit between beads of lead (Pb) and lead wire. |
| 7 | Resistance to Soldering Heat | <ul style="list-style-type: none"> · Resistance (R25°C) fluctuation rate: less than ±1%. · B-Constant (B25/50°C) fluctuation rate: less than ±1%. | Both lead wires are dipped into 350±10°C solder for 3.5±0.5 seconds, or 260±5°C solder for 10±1 seconds according to Fig-1. (solder <Sn-3Ag-0.5Cu>) <div style="text-align: center; margin-top: 10px;">  <p>Fig-1</p> </div> |
| 8 | Solderability | <ul style="list-style-type: none"> · More than 90% of lead wire surface shall be covered by solder. | Both lead wires are dipped into flux (25wt% colophony <JIS K 5902> isopropyl alcohol <JIS K 8839>) for 5 to 10 seconds. Then both lead wires are dipped into 245±5°C solder <Sn-3Ag-0.5Cu> for 2±0.5 seconds according to Fig-1. |
| 9 | Lead Wire Pull Strength | <ul style="list-style-type: none"> · Resistance(R25°C) fluctuation rate: less than ±1%. · B-Constant(B25/50°C) fluctuation rate: less than ±1%. · No visible damage at resin part. | One end of a lead wire shall be fixed and 2.5N force for 10 seconds shall be applied to the other lead wire as shown in Fig-2. <div style="text-align: center; margin-top: 10px;">  <p>Fig-2</p> </div> |
| 10 | Lead Wire Bending Strength | <ul style="list-style-type: none"> · Lead wire does not break. | One lead wire is held and 2.5N force is applied. Then the body of NTC thermistor is bent by 90° and again bent back to the initial position. This sequence shall be completed twice. See Fig-3. <div style="text-align: center; margin-top: 10px;">  <p>Fig-3</p> </div> |
| 11 | Free Fall | <ul style="list-style-type: none"> · Resistance (R25°C) fluctuation rate: less than ±1%. · B-Constant (B25/50°C) fluctuation rate: less than ±1%. · No visible damage at resin part. | NTC thermistor shall be dropped without any force onto concrete floor from 1 meter height one time. |
| 12 | Vibration | | NTC thermistor shall be fixed to the vibration test Equipment. Vibration of total 1.5mm amplitude, Frequency sequence of 10Hz – 55Hz – 10Hz in 1 minute, shall be applied for right angled 3 directions for 2 hours duration each. |

* · R25 is zero-power resistance at 25°C.
 · B25/50 is calculated by zero-power resistance of Thermistor in 25°C-50°C.
 · After each test, NTC Thermistor should be kept for 1 hour at room temperature (normal humidity and normal atmospheric pressure).

NTC Thermistors

Temperature Sensor Lead Insulation Type (Radial Type)

This thermistor is for normal temperature level sensors having self-subsistence due to strong lead strength based on chip NTC.

■ Features

1. NXR series can accurately detect temperature with NCP15 series on the head of parts.
2. The insulation coat with polyurethane on the surface of lead wire : 100VDC.
3. You can choose NTC characteristics from NCP15 series.
4. The resistance drift is low in the reliability test.
5. The production capacity is bigger and NXR is produced almost entirely in an automation line.
6. Adopt to Sb regulation

■ Applications

1. Secondary battery
2. Temperature detection for charging
3. Temperature detection for DC fan motor
4. Temperature sensing for appliance
5. Self-standing temperature sensing for fire detector



| Part Number | Resistance (25°C) (ohm) | B-Constant (25-50°C) (K) | B-Constant (25-80°C) (Reference Value) (K) | B-Constant (25-85°C) (Reference Value) (K) | B-Constant (25-100°C) (Reference Value) (K) | Operating Current for Sensor (25°C) (mA) | Rated Electric Power (25°C) (mW) | Typical Dissipation Constant (25°C) (mW/°C) | Thermal Time Constant (25°C) (s) |
|--------------------|-------------------------|--------------------------|--|--|---|--|----------------------------------|---|----------------------------------|
| NXRT15XM202EA5B□□□ | 2k ±3% | 3500 ±1% | 3539 | 3545 | 3560 | 0.36 | 13 | 2.6 | 4 |
| NXRT15XV502FA5B□□□ | 5k ±1% | 3936 ±1% | 3972 | 3977 | 3989 | 0.22 | 13 | 2.6 | 4 |
| NXRT15XH103FA5B□□□ | 10k ±1% | 3380 ±1% | 3428 | 3434 | 3455 | 0.16 | 13 | 2.6 | 4 |
| NXRT15XV103FA5B□□□ | 10k ±1% | 3936 ±1% | 3971 | 3977 | 3988 | 0.16 | 13 | 2.6 | 4 |
| NXRT15WB333JA5B□□□ | 33k ±5% | 4050 ±3% | 4101 | 4108 | 4131 | 0.08 | 13 | 2.6 | 4 |
| NXRT15WB473FA5B□□□ | 47k ±1% | 4050 ±1% | 4101 | 4108 | 4131 | 0.07 | 13 | 2.6 | 4 |
| NXRT15WF104FA5B□□□ | 100k ±1% | 4250 ±1% | 4303 | 4311 | 4334 | 0.05 | 13 | 2.6 | 4 |

□□□ is filled with Total-length codes. (25 to 45mm interval 5mm, ex. 040=40mm)

Operating Current for Sensor rises Thermistor's temperature by 0.1°C.

Rated Electric Power is necessary electric power that thermistor's temperature rises 5°C by self-heating at 25°C in still air.

Operating Temperature Range: -40°C to +125°C

Temperature Sensor Lead Insulation Type (Radial Type) Specifications and Test Methods

| No. | Item | Specifications | Test Methods |
|-----|--|---|--|
| 1 | Resistance to Soldering Heat (Flow) | <ul style="list-style-type: none"> · Resistance (R25°C) fluctuation rate: less than ±1%. · B-Constant (B25/50°C) fluctuation rate: less than ±1%. | <p>Both lead wires are dipped into 350±10°C solder for 3.5±0.5 seconds, or 260 ±5°C solder for 10±1 seconds according to Fig-1. (solder <SnAgCu>)</p> <div style="text-align: center;">  <p>Fig-1</p> </div> |
| 2 | Solderability (Flow) | <ul style="list-style-type: none"> · More than 90% of lead wire surface shall be covered by solder. | <p>Both lead wires are dipped into flux (25wt% colophony <JIS K 5902> isopropyl alcohol <JIS K 8839>) for 5 to 10 seconds. Then both lead wire are dipped into 245±5°C solder <SnAgCu> for 2±0.5 seconds according to Fig-1.</p> |
| 3 | Lead Wire Breaking Strength | <ul style="list-style-type: none"> · Resistance (R25°C) fluctuation rate: less than ±1%. · B-Constant (B25/50°C) fluctuation rate: less than ±1%. | <p>One end of a lead wire shall be fixed and 2.5N force for 10 seconds shall be applied to the other lead wire as shown in Fig-2.</p> <div style="text-align: center;">  <p>Fig-2</p> </div> |
| 4 | Lead Wire Bending Strength | <ul style="list-style-type: none"> · Lead wire does not break. | <p>One lead wire is held and 2.5N force is applied. Then the body of NTC thermistor is bent by 90° and again bent back to the initial position. This sequence shall be completed twice. See Fig-3.</p> <div style="text-align: center;">  <p>Fig-3</p> </div> |
| 5 | Free Fall | <ul style="list-style-type: none"> · Resistance (R25°C) fluctuation rate: less than ±1%. | <p>NTC thermistor shall be dropped without any force onto concrete floor from 1 meter height one time.</p> |
| 6 | Vibration | <ul style="list-style-type: none"> · B-Constant (B25/50°C) fluctuation rate: less than ±1%. · No visible damage at resin part. | <p>NTC thermistor shall be fixed to the vibration test equipment. Vibration of total 1.5 mm amplitude, frequency sequence of 10Hz - 55Hz - 10Hz in 1 minute, shall be applied for right angled 3 directions for 2 hours duration each.</p> |
| 7 | Cold | <ul style="list-style-type: none"> · Resistance (R25°C) fluctuation rate: less than ±1%. | <p>-40 +0/-3°C in air, for 1000 +48/-0 hours without loading.</p> |
| 8 | Dry Heat | <ul style="list-style-type: none"> · B-Constant (B25/50°C) fluctuation rate: less than ±1%. | <p>125±2°C in air, for 1000 +48/-0 hours without loading.</p> |
| 9 | High Temperature with Continuous Load | | <p>85±2°C in air, with 'Operating Current for Sensor' for 1000 +48/-0 hrs.</p> |
| 10 | Damp Heat | <ul style="list-style-type: none"> · Resistance (R25°C) fluctuation rate: less than ±2%. · B-Constant (B25/50°C) fluctuation rate: less than ±1%. | <p>60±2°C, 90 to 95%RH in air, for 1000 +48/-0 hours without loading.</p> |
| 11 | Change of Temperature | | <p>-40°C +0/-3°C, 30 minutes in air +25°C±2°C, 10 to 15 minutes in air +125°C +3/-0°C, 30 minutes in air +25°C +2/-0°C, 10 to 15 minutes in air (1 cycle) Continuous 100 +4/-0 cycles, without loading.</p> |
| 12 | Dielectric Breakdown Voltage | <ul style="list-style-type: none"> · No damage electrical characteristics on D.C.100V, 1 min. | <p>2mm length of coating resin from the top of thermistor is to be dipped into beads of lead (Pb), and DC100V 1 minute is applied to circuit between beads of lead (Pb) and lead wire.</p> |

Temperature Sensor Thermo String/Lead Type Temperature Characteristics (Center Value)

| Part Number | NXFT15XH103 | NXFT15XV103 | NXFT15WB473 | NXFT15WF104 |
|-------------|-----------------|-----------------|-----------------|-----------------|
| Resistance | 10kΩ | 10kΩ | 47kΩ | 100kΩ |
| B-Constant | 3380K | 3936K | 4050K | 4250K |
| Temp. (°C) | Resistance (kΩ) | Resistance (kΩ) | Resistance (kΩ) | Resistance (kΩ) |
| -40 | 197.388 | 337.503 | 1690.590 | 4221.280 |
| -35 | 149.395 | 243.332 | 1215.320 | 2995.040 |
| -30 | 114.345 | 177.496 | 882.908 | 2147.000 |
| -25 | 88.381 | 130.859 | 647.911 | 1554.600 |
| -20 | 68.915 | 97.428 | 480.069 | 1136.690 |
| -15 | 54.166 | 73.230 | 359.009 | 839.019 |
| -10 | 42.889 | 55.529 | 270.868 | 624.987 |
| -5 | 34.196 | 42.467 | 206.113 | 469.678 |
| 0 | 27.445 | 32.747 | 158.126 | 355.975 |
| 5 | 22.165 | 25.450 | 122.267 | 272.011 |
| 10 | 18.010 | 19.932 | 95.256 | 209.489 |
| 15 | 14.720 | 15.727 | 74.754 | 162.559 |
| 20 | 12.099 | 12.498 | 59.075 | 127.057 |
| 25 | 10.000 | 10.000 | 47.000 | 100.000 |
| 30 | 8.309 | 8.054 | 37.636 | 79.222 |
| 35 | 6.939 | 6.529 | 30.326 | 63.167 |
| 40 | 5.824 | 5.324 | 24.583 | 50.677 |
| 45 | 4.911 | 4.366 | 20.043 | 40.904 |
| 50 | 4.160 | 3.601 | 16.433 | 33.195 |
| 55 | 3.539 | 2.985 | 13.545 | 27.091 |
| 60 | 3.024 | 2.488 | 11.223 | 22.224 |
| 65 | 2.593 | 2.083 | 9.345 | 18.323 |
| 70 | 2.233 | 1.752 | 7.818 | 15.184 |
| 75 | 1.929 | 1.480 | 6.571 | 12.635 |
| 80 | 1.673 | 1.256 | 5.548 | 10.566 |
| 85 | 1.455 | 1.070 | 4.704 | 8.873 |
| 90 | 1.270 | 0.916 | 4.004 | 7.481 |
| 95 | 1.112 | 0.787 | 3.422 | 6.337 |
| 100 | 0.976 | 0.679 | 2.936 | 5.384 |
| 105 | 0.860 | 0.588 | 2.528 | 4.594 |
| 110 | 0.759 | 0.512 | 2.184 | 3.934 |
| 115 | 0.673 | 0.446 | 1.893 | 3.380 |
| 120 | 0.598 | 0.391 | 1.646 | 2.916 |
| 125 | 0.532 | 0.343 | 1.436 | 2.522 |

| Part Number | NXRT15XM202 | NXRT15XV502 | NXRT15XH103 | NXRT15XV103 | NXRT15WB333 | NXRT15WB473 | NXRT15WF104 |
|-------------|-----------------|-----------------|-----------------|-----------------|-----------------|-----------------|-----------------|
| Resistance | 2.0kΩ | 5.0kΩ | 10kΩ | 10kΩ | 33kΩ | 47kΩ | 100kΩ |
| B-Constant | 3500K | 3936K | 3380K | 3936K | 4050K | 4050K | 4250K |
| Temp. (°C) | Resistance (kΩ) | Resistance (kΩ) | Resistance (kΩ) | Resistance (kΩ) | Resistance (kΩ) | Resistance (kΩ) | Resistance (kΩ) |
| -40 | 44.981 | 168.752 | 195.652 | 337.503 | 1227.263 | 1747.920 | 4397.119 |
| -35 | 33.671 | 121.666 | 148.171 | 243.332 | 874.449 | 1245.428 | 3088.599 |
| -30 | 25.444 | 88.748 | 113.347 | 177.496 | 630.851 | 898.485 | 2197.225 |
| -25 | 19.417 | 65.430 | 87.559 | 130.859 | 460.457 | 655.802 | 1581.881 |
| -20 | 14.955 | 48.714 | 68.237 | 97.428 | 339.797 | 483.954 | 1151.037 |
| -15 | 11.619 | 36.615 | 53.650 | 73.230 | 253.363 | 360.850 | 846.579 |
| -10 | 9.097 | 27.764 | 42.506 | 55.529 | 190.766 | 271.697 | 628.988 |
| -5 | 7.178 | 21.233 | 33.892 | 42.467 | 144.964 | 206.463 | 471.632 |
| 0 | 5.707 | 16.374 | 27.219 | 32.747 | 111.087 | 158.214 | 357.012 |
| 5 | 4.568 | 12.725 | 22.021 | 25.450 | 85.842 | 122.259 | 272.500 |
| 10 | 3.682 | 9.966 | 17.926 | 19.932 | 66.861 | 95.227 | 209.710 |
| 15 | 2.986 | 7.864 | 14.674 | 15.727 | 52.470 | 74.730 | 162.651 |
| 20 | 2.437 | 6.249 | 12.081 | 12.498 | 41.471 | 59.065 | 127.080 |
| 25 | 2.000 | 5.000 | 10.000 | 10.000 | 33.000 | 47.000 | 100.000 |
| 30 | 1.651 | 4.027 | 8.315 | 8.054 | 26.430 | 37.643 | 79.222 |
| 35 | 1.370 | 3.264 | 6.948 | 6.529 | 21.298 | 30.334 | 63.167 |
| 40 | 1.143 | 2.662 | 5.834 | 5.324 | 17.266 | 24.591 | 50.677 |
| 45 | 0.958 | 2.183 | 4.917 | 4.366 | 14.076 | 20.048 | 40.904 |
| 50 | 0.807 | 1.801 | 4.161 | 3.601 | 11.538 | 16.433 | 33.195 |
| 55 | 0.682 | 1.493 | 3.535 | 2.985 | 9.506 | 13.539 | 27.091 |
| 60 | 0.580 | 1.244 | 3.014 | 2.488 | 7.870 | 11.209 | 22.224 |
| 65 | 0.495 | 1.041 | 2.586 | 2.083 | 6.549 | 9.328 | 18.323 |
| 70 | 0.424 | 0.876 | 2.228 | 1.752 | 5.475 | 7.798 | 15.184 |
| 75 | 0.365 | 0.740 | 1.925 | 1.480 | 4.595 | 6.544 | 12.635 |
| 80 | 0.315 | 0.628 | 1.669 | 1.256 | 3.874 | 5.518 | 10.566 |
| 85 | 0.273 | 0.535 | 1.452 | 1.070 | 3.282 | 4.674 | 8.873 |
| 90 | 0.237 | 0.458 | 1.268 | 0.916 | 2.789 | 3.972 | 7.481 |
| 95 | 0.207 | 0.394 | 1.110 | 0.787 | 2.379 | 3.388 | 6.337 |
| 100 | 0.181 | 0.340 | 0.974 | 0.679 | 2.038 | 2.902 | 5.384 |
| 105 | 0.160 | 0.294 | 0.858 | 0.588 | 1.751 | 2.494 | 4.594 |
| 110 | 0.141 | 0.256 | 0.758 | 0.512 | 1.509 | 2.150 | 3.934 |
| 115 | 0.124 | 0.223 | 0.672 | 0.446 | 1.306 | 1.860 | 3.380 |
| 120 | 0.110 | 0.195 | 0.596 | 0.391 | 1.134 | 1.615 | 2.916 |
| 125 | 0.098 | 0.172 | 0.531 | 0.343 | 0.987 | 1.406 | 2.522 |

Detailed Resistance - Temperature Tables are downloadable from the following URL.
<http://search.murata.co.jp/Ceramy/CatsearchAction.do?sLang=en>

Temperature Sensor Thermo String/Lead Type ⚠Caution/Notice

■ ⚠Caution (Storage and Operating Conditions)

This product is designed for application in an ordinary environment (normal room temperature, humidity and atmospheric pressure).

Do not use under the following conditions because all of these factors can deteriorate the product characteristics or cause failures and burn-out.

1. Corrosive gas or deoxidizing gas

(Chlorine gas, Hydrogen sulfide gas, Ammonia gas, Sulfuric acid gas, Nitric oxide gas, etc.)

2. Volatile or flammable gas

3. Dusty conditions

4. Under vacuum, or under high or low pressure

5. Wet or humid locations

6. Places with salt water, oils, chemical liquids or organic solvents

7. Strong vibrations

8. Other places where similar hazardous conditions exist

■ ⚠Caution (Others)

Be sure to provide an appropriate fail-safe function on your product to prevent secondary damage that may be caused by the abnormal function or the failure of our product.

■ Notice (Storage and Operating Conditions)

To keep the solderability of the product from degrading, the following storage condition is recommended.

1. Storage condition:

Temperature -10 to +40°C

Humidity less than 75%RH (not dewing condition)

2. Storage term:

Use this product within 6 months after delivery by first-in and first-out stocking system.

3. Handling after unpacking:

After unpacking, reseal product promptly or store it in a sealed container with a drying agent.

4. Storage place:

Do not store this product in corrosive gas (Sulfuric acid gas, Chlorine gas, etc.) or in direct sunlight.

■ Notice (Rating)

Use this product within the specified temperature range.

Higher temperature may cause deterioration of the characteristics or the material quality of this product.

■ Notice (Soldering and Mounting) NXF Series

Please note as shown below when you mount this product.

1. Do not melt the solder in the resin head when you solder this product. If you do so, there is a possibility of wire breakage, electric short mode failure and wire coating breakage. If you cut the lead wire of this product less than 20mm from the resin head, the heat of the melted solder at the lead wire edge is propagated easily to the resin head along the lead wire.

2. Do not touch the resin head directly with the soldering iron. It may cause the melting of solder in the resin head.
3. Do not separate the parallel lead wires 10mm or less from the resin.
4. If you mold this product with resin, please evaluate the quality of this product before you use it.
5. Do not bend the lead wire radius 1mm or more.

Continued on the following page. 

Temperature Sensor Thermo String/Lead Type ⚠Caution/Notice

☐ Continued from the preceding page.

■ Notice (Soldering and Mounting) NXR Series

Please note as shown below when you mount this product.

1. Do not melt the solder in the resin head, when you solder this product. If you melt the solder in resin the head, the wire could break and short.

If you cut the lead wire of this product less than 8mm from the resin head, the heat of the melted solder at the lead wire edge is propagated easily to the resin head along the lead wire. Please do not cut this product below 9mm.

2. Do not touch the resin head directly with the solder iron. It may cause the melting of solder in the resin head.
3. If you mold this product with resin, please evaluate the quality of this product before you use it.

■ Notice (Soldering and Mounting) NXR Series (Insulation Type)

Please note as shown below when you mount this product.

1. Do not melt the solder in the resin head when you solder this product. (more than 25mm in full length of the product).

If you melt the solder in the resin head, it has possibility that the wire could break and short.

2. Do not touch the resin head directly with the solder iron. It may cause the melting of solder in the resin head.
3. When additional processing is carried out on this product (such as bonding, resin molding, and resin coating, etc.), please perform an audit of quality level on an automated machine and only use the product after confirming its reliability.

Please talk to us if you have concern matter, like process it under the high temperature and the high pressure.

(For example, exposed to high-temperature and high-pressure environment as mold sealing with injection molding.)

■ Notice (Handling) NXF/NXR Series

1. The ceramic element of this product is fragile, and care must be taken not to load an excessive press-force or not to cause a shock at handling. Such forces may cause cracking or chipping.
2. Do not apply excessive force to the lead. Otherwise, it may cause the junction between lead and element to break or crack. Holding the element by the side lead wire is recommended when lead wire is bent or cut.

■ Notice (Handling) NXR Series (Insulation Type)

1. The ceramic element of this product is fragile, and care must be taken not to load an excessive press-force or not to cause a shock at handling. Such forces may cause cracking or chipping. Especially under high-temperature environment, there is a possibility that epoxy resin will become soft. When you set up the processing environment, please examine the processing method after evaluating the quality of this product.

2. Do not apply excessive force to the lead. Otherwise, it may cause the junction between lead and element to break or crack. Holding the element by the side lead wire is recommended when lead wire is bent or cut. Handle the lead with care; there is a possibility that a crack may go into the polyurethane insulated coat when bending the lead.

Temperature Sensor Thermo String/Lead Type Package

■ Minimum Order Quantity

| Bulk | | Ammo Pack Taping | |
|-------------|-------------------------|------------------|-------------------------|
| Part Number | Minimum Quantity (pcs.) | Part Number | Minimum Quantity (pcs.) |
| NXFT | 1,000 | - | - |
| NXRT | 500 | NXRT_3A016 | 2,500 |

■ Taping Dimensions (NXRT_3A016 Series)



| Item | Code | Dimensions (mm) |
|---|----------|------------------------------------|
| Pitch of Component | P | 12.7±1.0 |
| Pitch of Sprocket Hole | P0 | 12.7±0.3 |
| Lead Spacing | F | 5.0±1.0 |
| Length from Hole Center to Component Center | P2 | 6.35±1.3 |
| Length from Hole Center to Lead | P1 | 3.85±0.7 |
| Body Diameter | D | 4.0 max. |
| Deviation Along Tape, Left or Right | ΔS | 0±2.0 |
| Carrier Tape Width | W3 | 18.0±0.5 |
| Position of Sprocket Hole | W1 | 9.0±0.5 |
| Lead Distance between Reference and Bottom Planes | H0 | 16.0±1.0 |
| Height of Component | H3 | 7.5±1.0 |
| Protrusion Length | l | +0.5 to -1.0 |
| Diameter of Sprocket Hole | øD0 | 4.0±0.1 |
| Lead Diameter | ød | 0.40±0.05 |
| Total Tape Thickness | t1 | 0.6±0.3 |
| Total Thickness, Tape and Lead Wire | t2 | 1.6 max. |
| Deviation Across Tape | Δh1, Δh2 | 1.0 max. |
| Portion to Cut in Case of Defect | L3 | 11.0 ⁺⁰ _{-2.0} |
| Hold down Tape Width | W0 | 9.5 min. |
| Hold down Tape Position | W2 | 1.5±1.5 |
| Thickness | T | 2.0 max. |

NTC Thermistors

Inrush Current Suppression Lead Type

This product effectively suppresses surge currents that are generated when switching power regulators are turned on.

■ Features

1. Lead is not contained in the ceramic element, the terminations, the solder for inner connection and the coating resin.
2. Most suitable for power supplies of less than 100W
3. Excellent recovery characteristics due to resin coating with excellent heat characteristics
4. Highly reliable

■ Applications

1. Switching power supplies
2. CRT monitors
3. Color televisions
4. VCR power supplies
5. Other power circuits



| Part Number | Resistance (25°C) (ohm) | Permissible Max. Current (25°C) (A) | Permissible Max. Current (55°C) (A) | Thermal Time Constant (25°C) (s) | Thermal Dissipation Constant (25°C) (mW/°C) |
|---------------|-------------------------|-------------------------------------|-------------------------------------|----------------------------------|---|
| NTPAN3R0LDKB0 | 3.0 ±15% | 5.4 | 4.7 | 135 | 26.8 |
| NTPAN4R0LDKB0 | 4.0 ±15% | 4.7 | 4.1 | 130 | 26.8 |
| NTPAN6R0LDKB0 | 6.0 ±15% | 3.9 | 3.4 | 130 | 26.8 |
| NTPAJ4R0LDKB0 | 4.0 ±15% | 4.0 | 3.5 | 125 | 21.8 |
| NTPAJ6R0LDKB0 | 6.0 ±15% | 3.4 | 2.9 | 125 | 21.8 |
| NTPAJ8R0LDKB0 | 8.0 ±15% | 3.0 | 2.6 | 130 | 21.8 |
| NTPAJ100LDKB0 | 10.0 ±15% | 2.6 | 2.2 | 130 | 21.8 |
| NTPAD3R9LDNB0 | 3.9 ±15% | 3.3 | 2.9 | 65 | 18.2 |
| NTPAD5R1LDNB0 | 5.1 ±15% | 3.0 | 2.6 | 85 | 18.8 |
| NTPAD8R0LDNB0 | 8.0 ±15% | 2.7 | 2.3 | 65 | 18.7 |
| NTPAD160LDNB0 | 16.0 ±15% | 2.0 | 1.7 | 100 | 19.1 |
| NTPAA2R2LDNB0 | 2.2 ±15% | 3.7 | 3.2 | 70 | 13.5 |

Continued on the following page. ↗

☞ Continued from the preceding page.

| Part Number | Resistance (25°C) (ohm) | Permissible Max. Current (25°C) (A) | Permissible Max. Current (55°C) (A) | Thermal Time Constant (25°C) (s) | Thermal Dissipation Constant (25°C) (mW/°C) |
|---------------|-------------------------|-------------------------------------|-------------------------------------|----------------------------------|---|
| NTPAA3R9LDNB0 | 3.9 ±15% | 2.7 | 2.3 | 70 | 13.5 |
| NTPAA5R1LDNB0 | 5.1 ±15% | 2.5 | 2.2 | 70 | 13.5 |
| NTPAA8R2LDNB0 | 8.2 ±15% | 2.0 | 1.7 | 70 | 13.5 |
| NTPAA100LDNB0 | 10.0 ±15% | 1.7 | 1.5 | 70 | 13.5 |
| NTPA94R0LBMB0 | 4.0 ±15% | 2.5 | 2.2 | 65 | 11.6 |
| NTPA95R0LBMB0 | 5.0 ±15% | 2.3 | 2.0 | 65 | 11.6 |
| NTPA98R0LBMB0 | 8.0 ±15% | 1.8 | 1.6 | 65 | 11.6 |
| NTPA9100LBMB0 | 10.0 ±15% | 1.7 | 1.5 | 65 | 11.6 |
| NTPA9160LBMB0 | 16.0 ±15% | 1.4 | 1.2 | 65 | 11.6 |
| NTPA74R0LBMB0 | 4.0 ±15% | 2.3 | 2.0 | 40 | 9.4 |
| NTPA75R0LBMB0 | 5.0 ±15% | 1.9 | 1.6 | 40 | 9.4 |
| NTPA78R0LBMB0 | 8.0 ±15% | 1.7 | 1.5 | 40 | 9.5 |
| NTPA7100LBMB0 | 10.0 ±15% | 1.4 | 1.2 | 40 | 9.5 |
| NTPA7160LBMB0 | 16.0 ±15% | 1.2 | 1.0 | 40 | 9.9 |
| NTPA7220LBMB0 | 22.0 ±15% | 1.0 | 0.88 | 40 | 9.1 |
| NTPA64R0LBMB0 | 4.0 ±15% | 2.3 | 2.0 | 30 | 7.5 |
| NTPA64R7LBMB0 | 4.7 ±15% | 2.1 | 1.9 | 30 | 7.5 |
| NTPA68R0LBMB0 | 8.0 ±15% | 1.7 | 1.5 | 30 | 7.5 |
| NTPA55R0LBMB0 | 5.0 ±15% | 1.7 | 1.5 | 20 | 5.6 |
| NTPA5100LBMB0 | 10.0 ±15% | 1.2 | 1.1 | 20 | 5.6 |

NTPAD/NTPAA/NTPA9/NTPA7 series are also available on tape. The final alphabet of the part number should be "DNB0=>D6A0", "BNB0 =>B1A0".
 Operating Temperature Range: -20°C to +160°C

■ Permissible Electrolytic Capacitor

| Part Number | Voltage (AC) | | | | | |
|-------------|--------------|---------|---------|---------|---------|---------|
| | 100Vrms | 120Vrms | 132Vrms | 220Vrms | 240Vrms | 264Vrms |
| NTPAN | 8600μF | 5972μF | 4936μF | 1777μF | 1493μF | 1234μF |
| NTPAJ | 5000μF | 3472μF | 2870μF | 1033μF | 868μF | 717μF |
| NTPAD | 2700μF | 1875μF | 1550μF | 558μF | 469μF | 387μF |
| NTPAA | 1400μF | 972μF | 803μF | 289μF | 243μF | 201μF |
| NTPA9 | 800μF | 556μF | 459μF | 165μF | 139μF | 115μF |
| NTPA74R0 | 700μF | 486μF | 402μF | 145μF | 122μF | 100μF |
| NTPA75R0 | | | | | | |
| NTPA78R0 | 570μF | 396μF | 327μF | 118μF | 99μF | 82μF |
| NTPA7100 | | | | | | |
| NTPA7160 | 400μF | 278μF | 230μF | 83μF | 69μF | 57μF |
| NTPA7220 | | | | | | |
| NTPA64R0 | 620μF | 431μF | 356μF | 128μF | 108μF | 89μF |
| NTPA64R7 | | | | | | |
| NTPA68R0 | 560μF | 389μF | 321μF | 116μF | 97μF | 80μF |
| NTPA5 | 346μF | 240μF | 198μF | 71μF | 60μF | 50μF |

■ Application Circuit



■ Determination of Allowable Current



Current - R Ratio (RT/R25)/Current - Temperature Characteristics (Typical)

■ NTPAN3R0L Type



■ NTPAN4R0L Type



■ NTPAN6R0L Type



■ NTPAJ4R0L Type



■ NTPAJ6R0L Type



■ NTPAJ8R0L Type



8

■ NTPAJ100L Type



■ NTPAD3R9L Type



Continued on the following page. ↗

Current - R Ratio (RT/R25)/Current - Temperature Characteristics (Typical)

↳ Continued from the preceding page.

■ NTPAD5R1L Type



■ NTPAD8R0L Type



■ NTPAD160L Type



■ NTPAA2R2L Type



■ NTPAA3R9L Type



■ NTPAA5R1L Type



■ NTPAA8R2L Type



■ NTPAA100L Type



Continued on the following page. ↗

Current - R Ratio (RT/R25)/Current - Temperature Characteristics (Typical)

Continued from the preceding page.

■ NTPA94R0L Type



■ NTPA95R0L Type



■ NTPA98R0L Type



■ NTPA9100L Type



■ NTPA9160L Type



■ NTPA74R0L Type

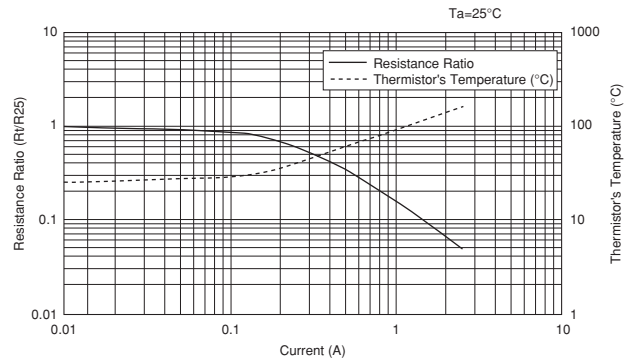

8

■ NTPA75R0L Type



■ NTPA78R0L Type

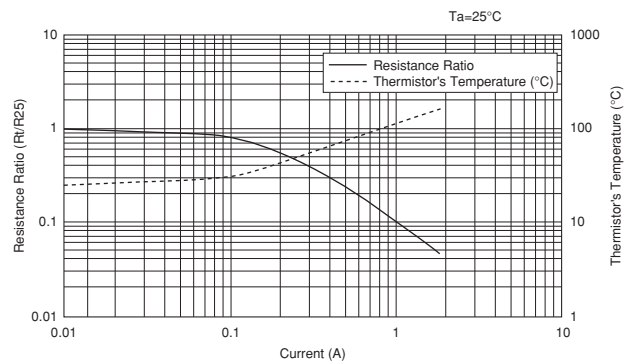

Continued on the following page. ↗

Current - R Ratio (RT/R25)/Current - Temperature Characteristics (Typical)

Continued from the preceding page.

■ NTPA7100L Type



■ NTPA7160L Type



■ NTPA7220L Type



■ NTPA64R0L Type



■ NTPA64R7L Type



■ NTPA68R0L Type



■ NTPA55R0L Type



■ NTPA5100L Type



Inrush Current Suppression Lead Type ⚠Caution/Notice

■ ⚠Caution (Storage and Operating Conditions)

1. This product is designed for Switching Power Supplies with smoothing capacitors.
Other applications of this product may result in fire.
2. Use this product within the specified maximum current.
Otherwise it may catch fire in the worst case.
3. Use this product with smoothing capacitors within the specified maximum capacitance value. Otherwise it may catch fire in the worst case.
4. This product is designed for application in an ordinary environment
(normal room temperature, humidity and atmospheric pressure).

Do not use under the following conditions because all these factors can deteriorate the product characteristics cause failure and burn-out.

- (1) Corrosive gas or deoxidizing gas.
(Chlorine gas, Hydrogen sulfide gas, Ammonia gas, Sulfuric acid gas, Nitric oxide gas, etc.)
- (2) Volatile or flammable gas
- (3) Dusty conditions
- (4) Under high or low pressure
- (5) Wet or humid conditions
- (6) Near with salt water, oils, chemical liquids or organic solvents
- (7) Strong vibrations
- (8) Other places where similar hazardous conditions exist.

■ ⚠Caution (Others)

Be sure to provide an appropriate fail-safe function on your product to prevent secondary damage that may be caused by the abnormal function or the failure of our product.

■ Notice (Storage and Operating Conditions)

To keep the solderability of the product from degrading, the following storage condition is recommended.

1. Storage condition:
Temperature -10 to +40°C
Humidity less than 75%RH (not dewing condition)
2. Storage term:
Use this product within 6 months after delivery by first-in and first-out stocking system.

3. Handling after unpacking:
After unpacking, reseal product promptly or store it in a sealed container with a drying agent.
4. Storage place:
Do not store this product in corrosive gas (Sulfuric acid gas, Chlorine gas, etc.) or in direct sunlight.

■ Notice (Rating)

Use this product within the specified temperature range.
Higher temperature may cause deterioration of the characteristics or the material quality of this product.

■ Notice (Soldering and Mounting)

1. Be sure that the preheat-up does not melt the soldering of this product. Excessive heat may cause failure to open, short or insulation break down.
2. Do not touch the body with the soldering iron.
The soldering point should be min. 5mm away from the root of the lead wire.

Inrush Current Suppression Lead Type ⚠Caution/Notice

■ Notice (Handling)

1. When this product is operated, the temperature of some areas may be about 160°C.
Use proper surrounding parts and material that withstand such temperature. If they are inadequate and kept at high temperature for a long time, they may be deteriorated or may produce harmful gas. Such harmful gas may deteriorate the element of this product.
2. This product does not have waterproof construction. Splashed water may cause failure mode such as deterioration of characteristics or current leak. Therefore, do not apply clean by immersing it into water or any solvent.

3. The ceramic element of this product is fragile, and care must be taken not to load an excessive press-force or not to cause a shock at handling. Such forces may cause cracking or chipping to the element.
4. Do not apply excessive force to the lead wire. Otherwise, it may cause the junction between lead wire and element to break or crack, or may crack the element. Therefore, fix the lead wire of the element side when the lead wire is bent or cut.

■ Notice (Others)

1. This product may allow the passing of higher current than its initial value if it receives inrush current again before it cools down enough to recover its original resistance.
Be sure to consider the highest current under actual operating conditions operating temperature.
2. The resin coating of this product does not guarantee insulating. Keep an adequate insulating distance from surrounding parts.

Inrush Current Suppression Lead Type Package

Minimum Order Quantity

| Bulk | | Ammo Pack Taping | |
|-------------|-------------------------|------------------|-------------------------|
| Part Number | Minimum Quantity (pcs.) | Part Number | Minimum Quantity (pcs.) |
| NTPAN_DKB0 | 50 | - | - |
| NTPAJ_DKB0 | 100 | - | - |
| NTPAD_DNB0 | 150 | NTPAD_D6A0 | 400 |
| NTPAA_DNB0 | 300 | NTPAA_D6A0 | 750 |
| NTPA9_BMB0 | 300 | NTPA9_B1A0 | 1,000 |
| NTPA7_BMB0 | 500 | NTPA7_B1A0 | 1,000 |
| NTPA6_BMB0 | 500 | NTPA6_B1A0 | 1,000 |
| NTPA5_BMB0 | 500 | NTPA5_B1A0 | 1,500 |

Taping Dimensions (NTPAD/A_D6A0 Series)



| Item | Code | Dimensions (mm) |
|--|-----------------------------------|------------------------------------|
| Pitch of Component | P | 30.0 |
| Pitch of Sprocket Hole | P ₀ | 15.0±0.3 |
| Lead Spacing | F | 7.5±0.5 |
| Length from Hole Center to Component Center | P ₂ | 7.5±1.5 |
| Length from Hole Center to Lead | P ₁ | 3.75±1.0 |
| Body Diameter | D | (refer to the table below) |
| Body Thickness | T | (refer to the table below) |
| Deviation Along Tape, Left or Right | ΔS | ±2.0 |
| Carrier Tape Width | W | 18.0±0.5 |
| Position of Sprocket Hole | W ₁ | 9.0±0.5 |
| Lead Distance between Reference and Bottom Plane | H ₀ | 16.0±0.5 |
| Height of Component | H ₂ | 10.0 max. |
| Protrusion Length | l | +0.5 to -6.0 |
| Diameter of Sprocket Hole | D ₀ | 4.0±0.1 |
| Lead Diameter | d | 0.8±0.05 |
| Total Tape Thickness | t ₁ | 0.6±0.3 |
| Total Thickness, Tape and Lead Wire | t ₂ | 2.0 max. |
| Deviation Across Tape | Δh ₁ , Δh ₂ | 2.0 max. |
| Portion to Cut in Case of Defect | L | 11.0 ⁺⁰ _{-2.0} |
| Hold down Tape Width | W ₀ | 11.5 min. |
| Hold down Tape Position | W ₂ | 4.0 max. |
| Coating Extension on Lead | e | to line A |

| Type | D (mm) | T (mm) |
|-------|-----------|----------|
| NTPAD | 16.0 max. | 5.5 max. |
| NTPAA | 12.0 max. | 5.0 max. |

Continued on the following page.

Inrush Current Suppression Lead Type Package

Continued from the preceding page.

Taping Dimensions (NTPA9/7/6/5_B1A0 Series)



| Item | Code | Dimensions (mm) |
|---|-----------------------------------|--------------------------------------|
| Pitch of Component | P | 12.7 |
| Pitch of Sprocket Hole | P ₀ | 12.7±0.3 |
| Lead Spacing | F | 5.0 ^{+0.8} _{-0.3} |
| Length from Hole Center to Component Center | P ₂ | 6.35±1.3 |
| Length from Hole Center to Lead | P ₁ | 3.85±0.8 |
| Body Diameter | D | (refer to the table below) |
| Body Thickness | T | 5.0 max. |
| Deviation Along Tape, Left or Right | ΔS | ±1.5 |
| Carrier Tape Width | W | 18.0±0.5 |
| Position of Sprocket Hole | W ₁ | 9.0 ^{+0.5} _{-0.75} |
| Lead Distance between Reference and Bottom Planes | H ₀ | 16.0±1.0 |
| Height of Component | H ₂ | 6.0 max. |
| Protrusion Length | l | +0.5 to -4.0 |
| Diameter of Sprocket Hole | D ₀ | 4.0±0.3 |
| Lead Diameter | d | 0.6±0.05 |
| Total Tape Thickness | t ₁ | 0.6±0.3 |
| Total Thickness, Tape and Lead Wire | t ₂ | 2.0 max. |
| Deviation Across Tape | Δh ₁ , Δh ₂ | 1.5 max. |
| Portion to Cut in Case of Defect | L | 11.0 ⁺⁰ _{-2.0} |
| Hold down Tape Width | W ₀ | 11.0 min. |
| Hold down Tape Position | W ₂ | 4.0 max. |
| Coating Extension on Lead | e | to line A |

| Type | D (mm) |
|-------|-----------|
| NTPA9 | 11.0 max. |
| NTPA7 | 9.0 max. |
| NTPA6 | 7.5 max. |
| NTPA5 | 6.0 max. |

Global Locations

For details please visit www.murata.com



⚠ Note

1 Export Control

For customers outside Japan:

No Murata products should be used or sold, through any channels, for use in the design, development, production, utilization, maintenance or operation of, or otherwise contribution to (1) any weapons (Weapons of Mass Destruction [nuclear, chemical or biological weapons or missiles] or conventional weapons) or (2) goods or systems specially designed or intended for military end-use or utilization by military end-users.

For customers in Japan:

For products which are controlled items subject to the "Foreign Exchange and Foreign Trade Law" of Japan, the export license specified by the law is required for export.

2 Please contact our sales representatives or product engineers before using the products in this catalog for the applications listed below, which require especially high reliability for the prevention of defects which might directly damage a third party's life, body or property, or when one of our products is intended for use in applications other than those specified in this catalog.

- ① Aircraft equipment
- ② Aerospace equipment
- ③ Undersea equipment
- ④ Power plant equipment
- ⑤ Medical equipment
- ⑥ Transportation equipment (vehicles, trains, ships, etc.)
- ⑦ Traffic signal equipment
- ⑧ Disaster prevention / crime prevention equipment
- ⑨ Data-processing equipment
- ⑩ Application of similar complexity and/or reliability requirements to the applications listed above

3 Product specifications in this catalog are as of December 2014. They are subject to change or our products in it may be discontinued without advance notice. Please check with our sales representatives or product engineers before ordering. If there are any questions, please contact our sales representatives or product engineers.

4 Please read rating and ⚠CAUTION (for storage, operating, rating, soldering, mounting and handling) in this catalog to prevent smoking and/or burning, etc.

5 This catalog has only typical specifications. Therefore, please approve our product specifications or transact the approval sheet for product specifications before ordering.

6 Please note that unless otherwise specified, we shall assume no responsibility whatsoever for any conflict or dispute that may occur in connection with the effect of our and/or a third party's intellectual property rights and other related rights in consideration of your use of our products and/or information described or contained in our catalogs. In this connection, no representation shall be made to the effect that any third parties are authorized to use the rights mentioned above under licenses without our consent.

7 No ozone depleting substances (ODS) under the Montreal Protocol are used in our manufacturing process.

Murata Manufacturing Co., Ltd.

www.murata.com

muRata
INNOVATOR IN ELECTRONICS



Компания «ЭлектроПласт» предлагает заключение долгосрочных отношений при поставках импортных электронных компонентов на взаимовыгодных условиях!

Наши преимущества:

- Оперативные поставки широкого спектра электронных компонентов отечественного и импортного производства напрямую от производителей и с крупнейших мировых складов;
- Поставка более 17-ти миллионов наименований электронных компонентов;
- Поставка сложных, дефицитных, либо снятых с производства позиций;
- Оперативные сроки поставки под заказ (от 5 рабочих дней);
- Экспресс доставка в любую точку России;
- Техническая поддержка проекта, помощь в подборе аналогов, поставка прототипов;
- Система менеджмента качества сертифицирована по Международному стандарту ISO 9001;
- Лицензия ФСБ на осуществление работ с использованием сведений, составляющих государственную тайну;
- Поставка специализированных компонентов (Xilinx, Altera, Analog Devices, Intersil, Interpoint, Microsemi, Aeroflex, Peregrine, Syfer, Eurofarad, Texas Instrument, Miteq, Cobham, E2V, MA-COM, Hittite, Mini-Circuits, General Dynamics и др.);

Помимо этого, одним из направлений компании «ЭлектроПласт» является направление «Источники питания». Мы предлагаем Вам помощь Конструкторского отдела:

- Подбор оптимального решения, техническое обоснование при выборе компонента;
- Подбор аналогов;
- Консультации по применению компонента;
- Поставка образцов и прототипов;
- Техническая поддержка проекта;
- Защита от снятия компонента с производства.



Как с нами связаться

Телефон: 8 (812) 309 58 32 (многоканальный)

Факс: 8 (812) 320-02-42

Электронная почта: org@eplast1.ru

Адрес: 198099, г. Санкт-Петербург, ул. Калинина, дом 2, корпус 4, литера А.