



STEVAL-ISA113V1

Wide range single-output demonstration board based on the
VIPER06HS

Data brief

Features

- Universal input mains range:
 - input voltage 90 - 265 V_{AC}
 - frequency 45 - 65 Hz
- Single-output voltage: 12 V at 0.35 A continuous operation
- Standby mains consumption: < 30 mW at 230 V_{AC}
- Average efficiency: > 74%
- Fully protected against faults (overload, feedback disconnection and overheating)
- EMI: according to EN55022-Class-B
- RoHS compliant

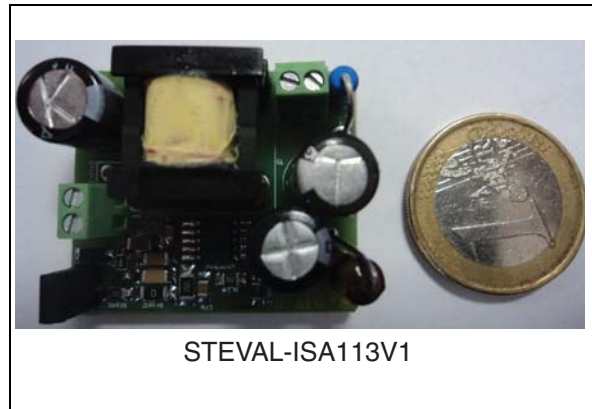

Description

The STEVAL-ISA113V1 demonstration board is a 12 V-0.35 A power supply set in non-isolated flyback topology using the new VIPER06HS offline high-voltage converter by STMicroelectronics.

The features of the device include an 800 V avalanche rugged power section, PWM operation at 115 kHz with frequency jittering for lower EMI, current limiting with adjustable set point, onboard soft-start, a safe auto-restart after a fault condition and a low standby power.

The protection features available include a thermal shutdown with hysteresis, delayed overload protection, and open loop failure protection.

1 Adapter features

The electrical specifications are given in [Table 1](#), the schematic in [Figure 1](#), and the bill of material in [Table 2](#).

Table 1. Electrical specifications

Parameter	Symbol	Value
Input voltage range	V_{IN}	[90 V _{AC} ; 265 V _{AC}]
Output voltage	V_{OUT}	12 V
Max. output current	I_{OUT}	0.35 A
Precision of output regulation	ΔV_{OUT_LF}	±5%
High frequency output voltage ripple	ΔV_{OUT_HF}	50 mV
Max. ambient operating temperature	T_{AMB}	60 °C

Table 2. Bill of material

Ref.	Part	Description	Package	Manufacturer
Cin1		2.2 μ F, 400 V NHG series electrolytic capacitor		
Cin2		4.7 μ F, 400 V AX series electrolytic capacitor		Saxon
CVDD		1 μ F, 50 V electrolytic capacitor	1206	Murata
Cfilt1		100 nF, 50 V ceramic capacitor	0805	
Cfilt2	Not mounted			
Cc		10 nF, 50 V ceramic capacitor	1206	
Cp		1 nF, 50 V ceramic capacitor	1206	
Cfb		1 nF, 50 V ceramic capacitor	0805	
Cout		330 μ F, 16 V ZL series ultra-low ESR electrolytic cap.		Rubycon
D0	MB6S	600 V, 1 A diode bridge	TO-269AA	Vishay
D2	STPS2H100	100 V, 2 A power Schottky rectifier	SMA	ST
Daux	1N4148W	Surface mount fast switching diode	SOD-123	Zetex
R0		4.7 Ω 3/4 W resistor		
RLIM		15 k Ω 5% 1/4 W resistor	0805	
Rc		47 k Ω 5% 1/4 W resistor	0805	
RfbH1		33 k Ω 1% 1/4 W resistor	0805	
RfbH2		0 Ω	1206	
RfbL1		12 k Ω 1% 1/4 W resistor	1206	
RfbL2		0.47 k Ω 1% 1/4 W resistor	0805	

Table 2. Bill of material (continued)

Ref.	Part	Description	Package	Manufacturer
IC1	VIPer06HS	Offline high-voltage PWM controller	SSO-10	ST
T1	1921.0040	Transformer		Magnetica
Lin	B82144A2105J	1 mH inductor LBC series		Epcos

The transformer core is a standard E13. The output voltage value is set in a simple way through the RfbH-RfbL voltage divider between the output terminal and the FB pin, according to the following formula:

Equation 1

$$V_{OUT} = 3.3V \cdot \left(1 + \frac{R_{fbH}}{R_{fbL}} \right)$$

In the schematic, RfbH has been split into RfbH1 and RfbH2; and RfbL into RfbL1 and RfbL2 in order to allow a better tuning of the output voltage value.

If the jumper J1 is not selected, the IC is biased through the internal HV-startup current generator (“self-biasing”).

If low standby consumption and good efficiency performance are required, the HV-startup current generator must be excluded. This can be done selecting the jumper J1, which connects the output terminal to the V_{DD} pin through a small signal diode. The IC biasing through the output is referred to as “external biasing”.

Figure 1. Application schematic

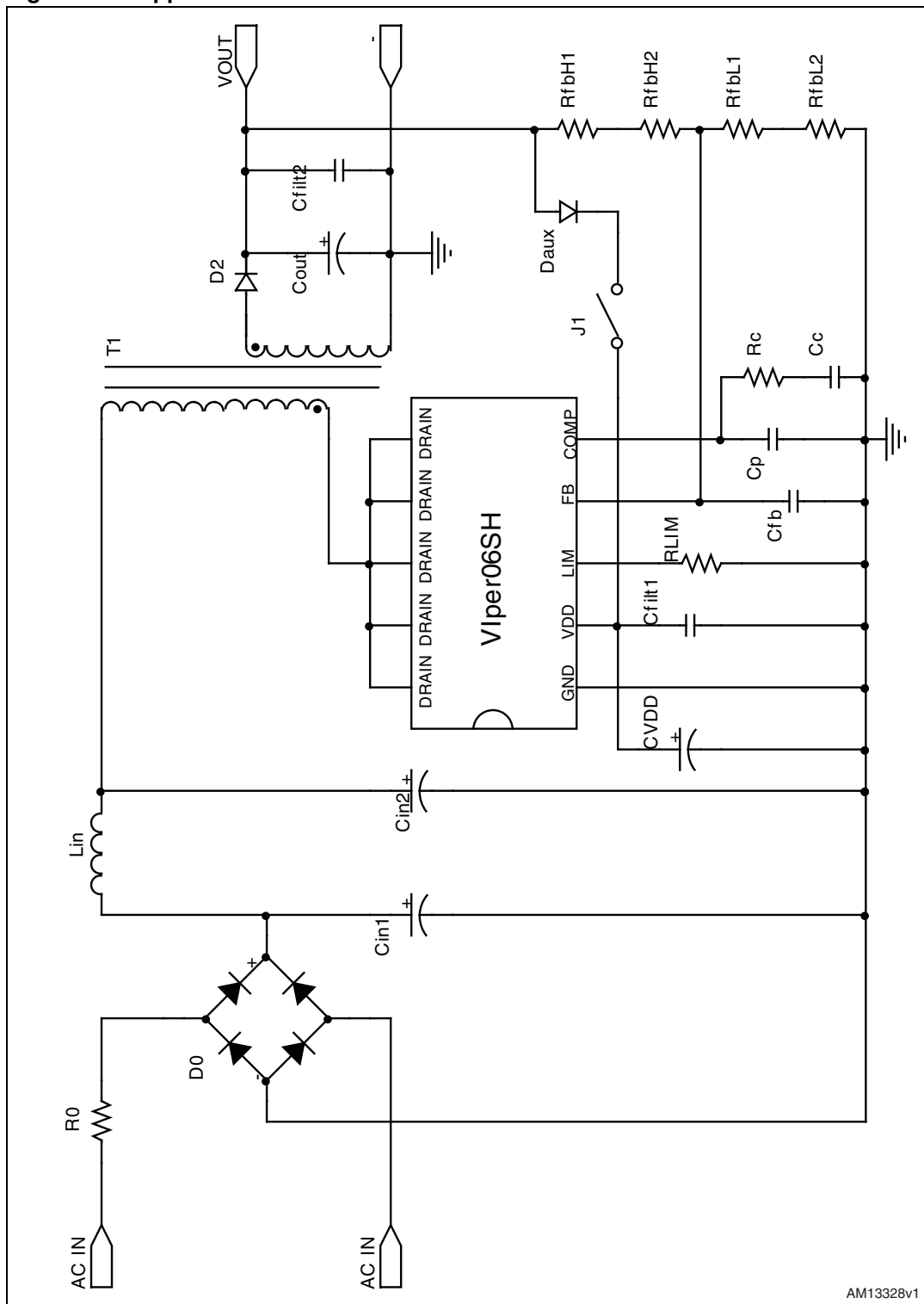

AM13328v1

2 Measurements

Figure 2. Line regulation at different loads: IC externally biased (J1 selected)

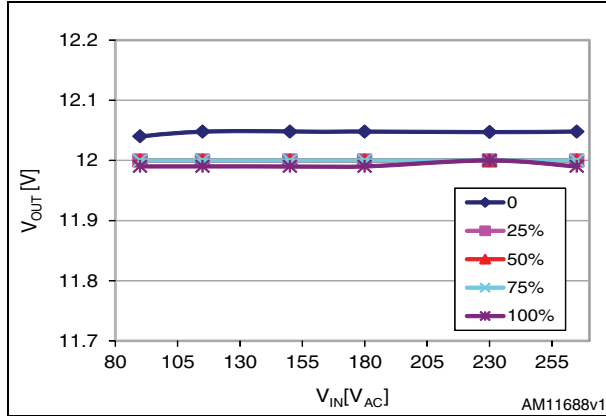

Figure 3. Line regulation at different loads: IC self-biased (J1 not selected)

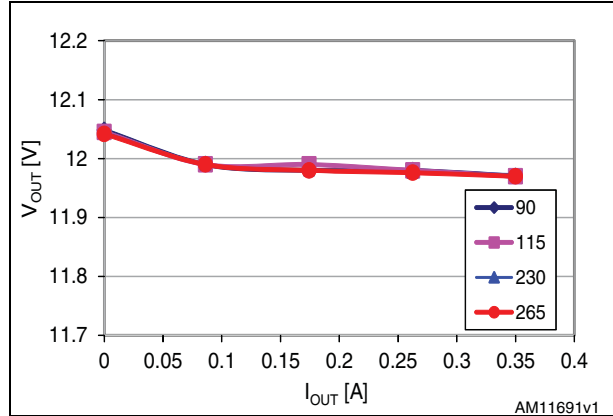

Figure 4. Efficiency vs. Vin IC externally biased (J1 selected)

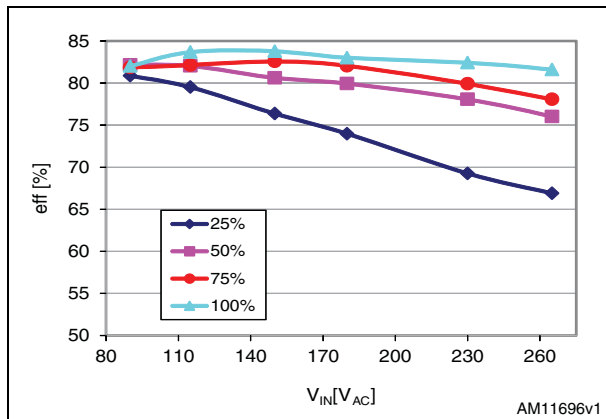

Figure 5. Efficiency vs. Vin IC self-biased (J1 not selected)

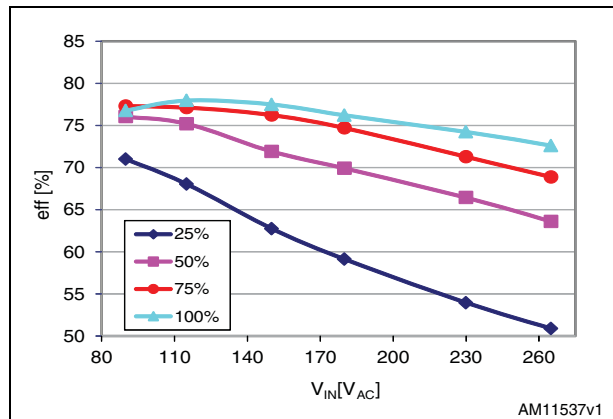

Figure 6. Efficiency at different input voltages: IC externally biased (J1 selected)

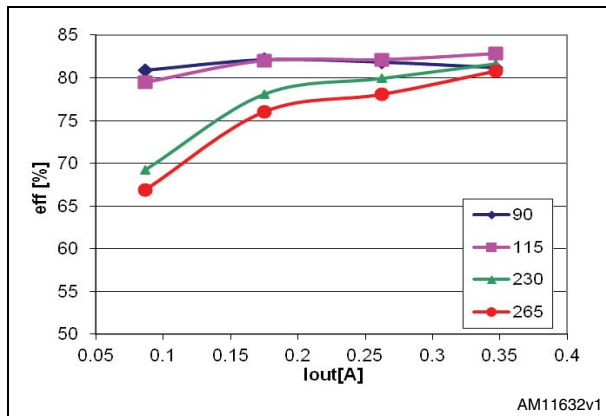

Figure 7. Efficiency at different input voltages: IC self-biased (J1 not selected)

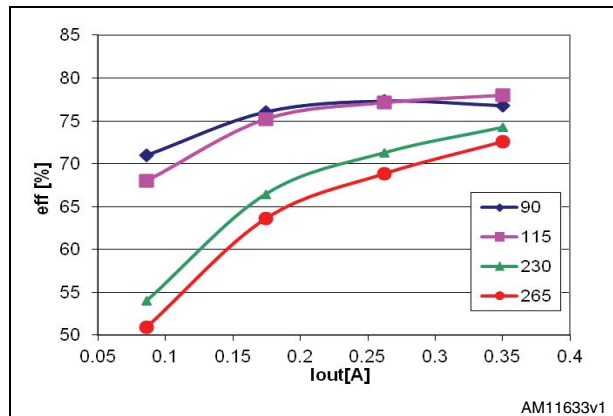

Figure 8. Active mode efficiency vs. V_{IN} IC externally biased (J1 selected)

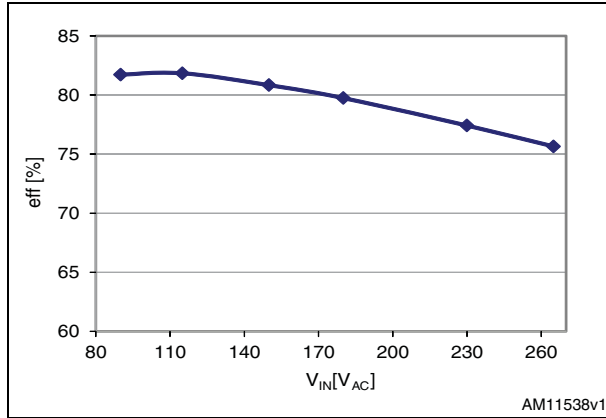

Figure 9. Active mode efficiency vs. V_{IN} IC self-biased (J1 not selected)

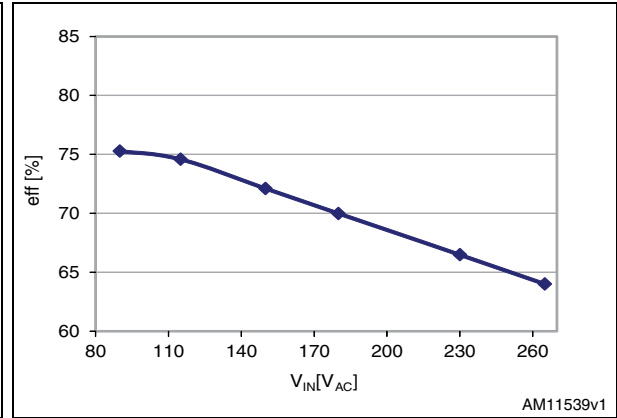

Figure 10. Input voltage averaged efficiency vs. load IC externally biased (J1 selected)

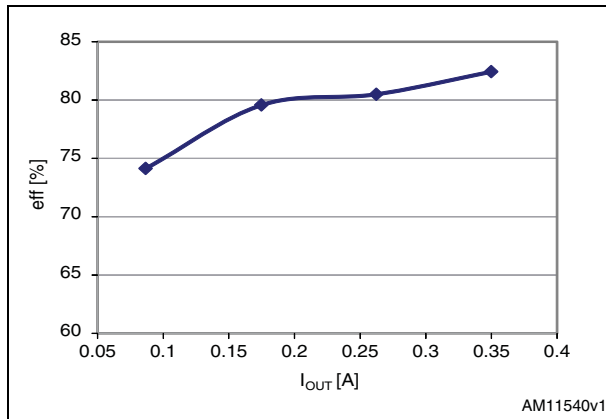

Figure 11. Input voltage averaged efficiency vs. load IC self-biased (J1 not selected)

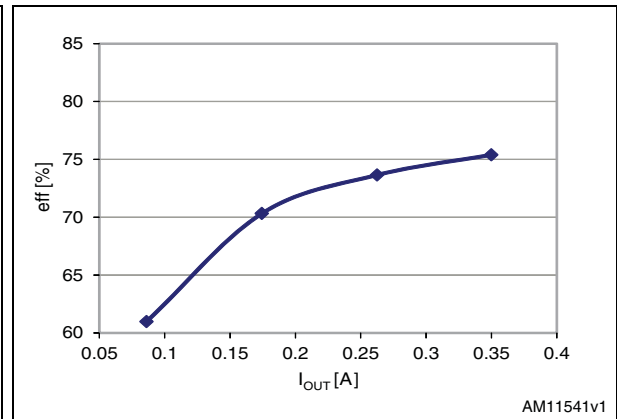

Figure 12. P_{IN} vs. V_{IN} at no load and light load: IC externally biased (J1 selected)

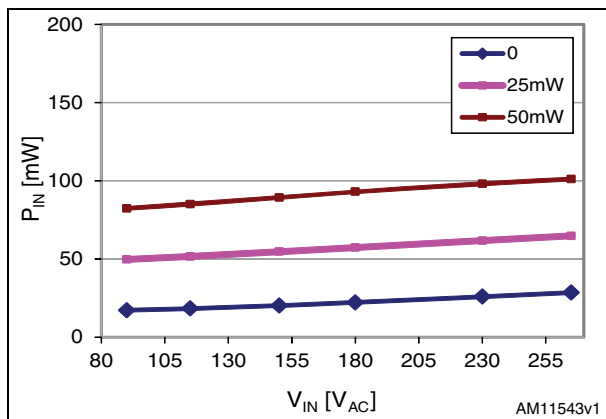

Figure 13. P_{IN} vs. V_{IN} at no load and light load: IC self-biased (J1 not selected)

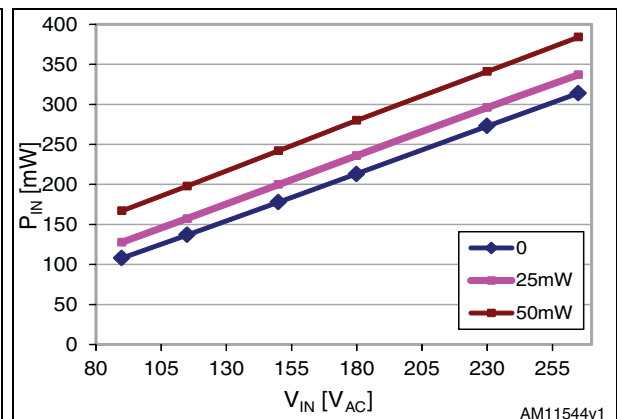

Figure 14. Efficiency at $P_{IN} = 1\text{ W}$: IC externally biased (J1 selected)

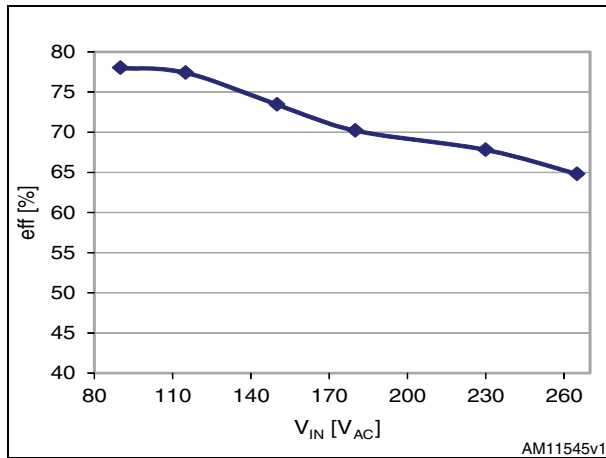

Figure 15. Efficiency at $P_{IN} = 1\text{ W}$: IC self-biased (J1 not selected)

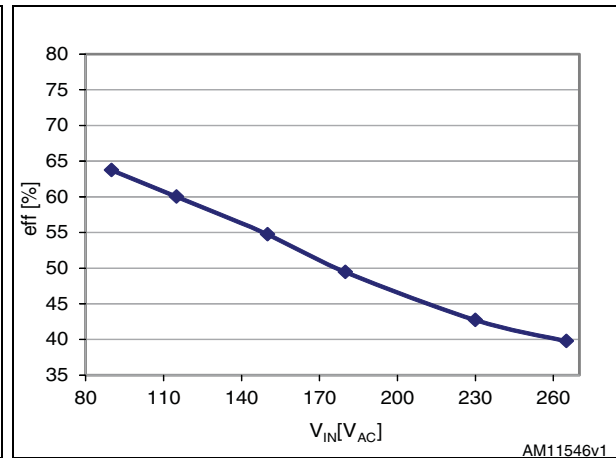

Figure 16. P_{IN} at $P_{OUT} = 250\text{ mW}$: IC externally biased (J1 selected)

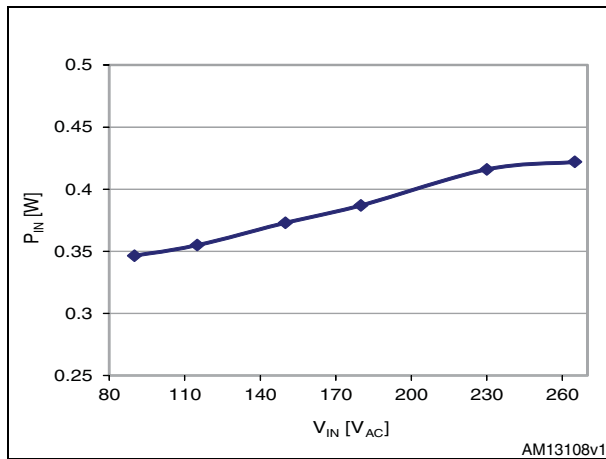
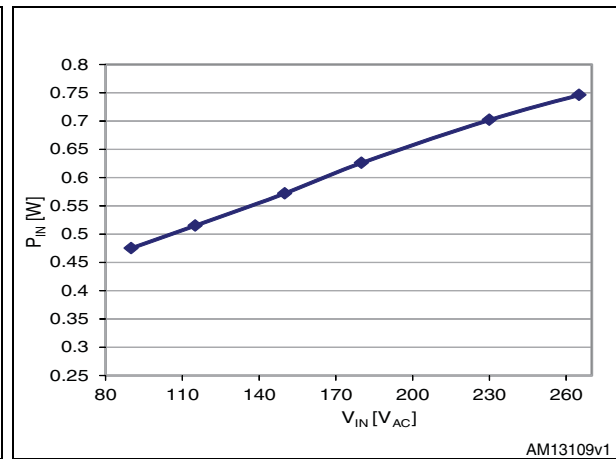

Figure 17. P_{IN} at $P_{OUT} = 250\text{ mW}$: IC self-biased (J1 not selected)



3 Board layout

Figure 18. Board layout - complete

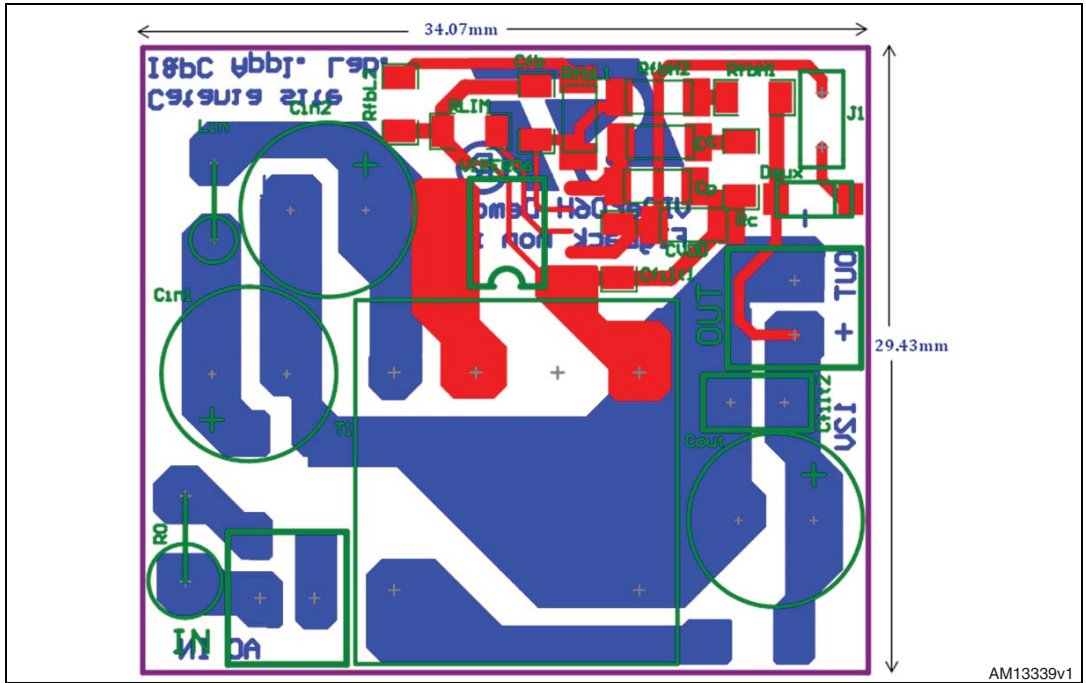
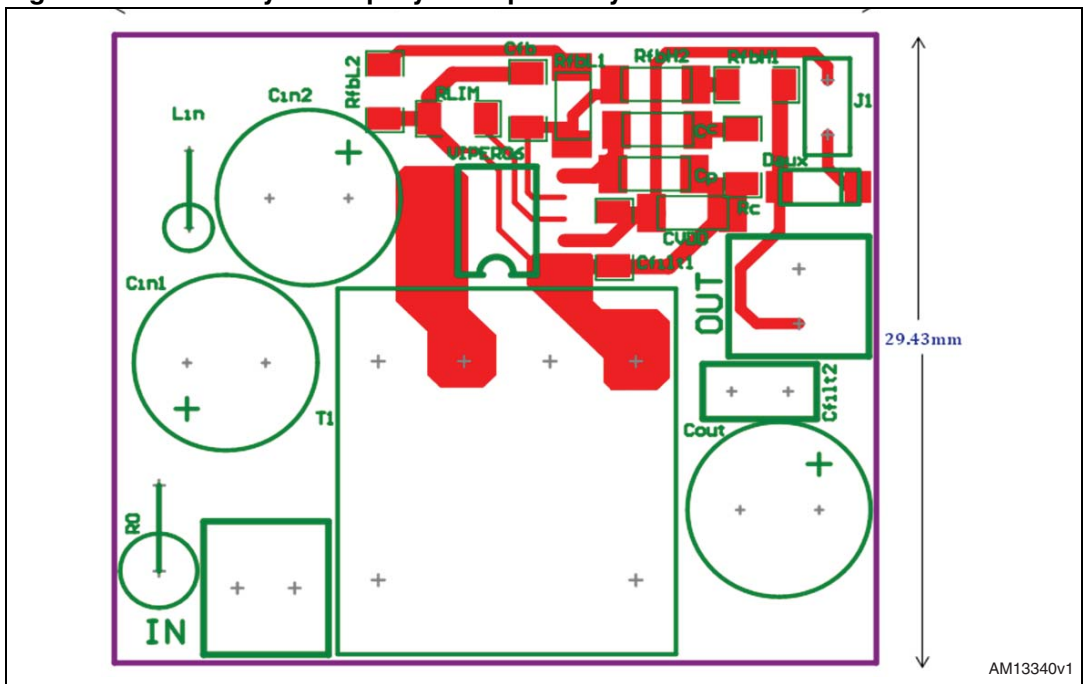

Figure 19. Board layout - top layer + top overlay



4 Revision history

Table 3. Document revision history

Date	Revision	Changes
10-Jan-2013	1	Initial release.

Please Read Carefully:

Information in this document is provided solely in connection with ST products. STMicroelectronics NV and its subsidiaries ("ST") reserve the right to make changes, corrections, modifications or improvements, to this document, and the products and services described herein at any time, without notice.

All ST products are sold pursuant to ST's terms and conditions of sale.

Purchasers are solely responsible for the choice, selection and use of the ST products and services described herein, and ST assumes no liability whatsoever relating to the choice, selection or use of the ST products and services described herein.

No license, express or implied, by estoppel or otherwise, to any intellectual property rights is granted under this document. If any part of this document refers to any third party products or services it shall not be deemed a license grant by ST for the use of such third party products or services, or any intellectual property contained therein or considered as a warranty covering the use in any manner whatsoever of such third party products or services or any intellectual property contained therein.

UNLESS OTHERWISE SET FORTH IN ST'S TERMS AND CONDITIONS OF SALE ST DISCLAIMS ANY EXPRESS OR IMPLIED WARRANTY WITH RESPECT TO THE USE AND/OR SALE OF ST PRODUCTS INCLUDING WITHOUT LIMITATION IMPLIED WARRANTIES OF MERCHANTABILITY, FITNESS FOR A PARTICULAR PURPOSE (AND THEIR EQUIVALENTS UNDER THE LAWS OF ANY JURISDICTION), OR INFRINGEMENT OF ANY PATENT, COPYRIGHT OR OTHER INTELLECTUAL PROPERTY RIGHT.

UNLESS EXPRESSLY APPROVED IN WRITING BY TWO AUTHORIZED ST REPRESENTATIVES, ST PRODUCTS ARE NOT RECOMMENDED, AUTHORIZED OR WARRANTED FOR USE IN MILITARY, AIR CRAFT, SPACE, LIFE SAVING, OR LIFE SUSTAINING APPLICATIONS, NOR IN PRODUCTS OR SYSTEMS WHERE FAILURE OR MALFUNCTION MAY RESULT IN PERSONAL INJURY, DEATH, OR SEVERE PROPERTY OR ENVIRONMENTAL DAMAGE. ST PRODUCTS WHICH ARE NOT SPECIFIED AS "AUTOMOTIVE GRADE" MAY ONLY BE USED IN AUTOMOTIVE APPLICATIONS AT USER'S OWN RISK.

Resale of ST products with provisions different from the statements and/or technical features set forth in this document shall immediately void any warranty granted by ST for the ST product or service described herein and shall not create or extend in any manner whatsoever, any liability of ST.

ST and the ST logo are trademarks or registered trademarks of ST in various countries.

Information in this document supersedes and replaces all information previously supplied.

The ST logo is a registered trademark of STMicroelectronics. All other names are the property of their respective owners.

© 2013 STMicroelectronics - All rights reserved

STMicroelectronics group of companies

Australia - Belgium - Brazil - Canada - China - Czech Republic - Finland - France - Germany - Hong Kong - India - Israel - Italy - Japan - Malaysia - Malta - Morocco - Philippines - Singapore - Spain - Sweden - Switzerland - United Kingdom - United States of America

www.st.com





Компания «ЭлектроПласт» предлагает заключение долгосрочных отношений при поставках импортных электронных компонентов на взаимовыгодных условиях!

Наши преимущества:

- Оперативные поставки широкого спектра электронных компонентов отечественного и импортного производства напрямую от производителей и с крупнейших мировых складов;
- Поставка более 17-ти миллионов наименований электронных компонентов;
- Поставка сложных, дефицитных, либо снятых с производства позиций;
- Оперативные сроки поставки под заказ (от 5 рабочих дней);
- Экспресс доставка в любую точку России;
- Техническая поддержка проекта, помощь в подборе аналогов, поставка прототипов;
- Система менеджмента качества сертифицирована по Международному стандарту ISO 9001;
- Лицензия ФСБ на осуществление работ с использованием сведений, составляющих государственную тайну;
- Поставка специализированных компонентов (Xilinx, Altera, Analog Devices, Intersil, Interpoint, Microsemi, Aeroflex, Peregrine, Syfer, Eurofarad, Texas Instrument, Miteq, Cobham, E2V, MA-COM, Hittite, Mini-Circuits, General Dynamics и др.);

Помимо этого, одним из направлений компании «ЭлектроПласт» является направление «Источники питания». Мы предлагаем Вам помощь Конструкторского отдела:

- Подбор оптимального решения, техническое обоснование при выборе компонента;
- Подбор аналогов;
- Консультации по применению компонента;
- Поставка образцов и прототипов;
- Техническая поддержка проекта;
- Защита от снятия компонента с производства.



Как с нами связаться

Телефон: 8 (812) 309 58 32 (многоканальный)

Факс: 8 (812) 320-02-42

Электронная почта: org@eplast1.ru

Адрес: 198099, г. Санкт-Петербург, ул. Калинина, дом 2, корпус 4, литера А.