

Wide Input Voltage Range Precision Voltage Reference

POWER MANAGEMENT

Features

- V_{IN} Voltage Range: $V_{OUT} + 0.9V$ to 28V
- V_{OUT} : Fixed 3.3V
- V_{OUT} High Accuracy ($\pm 1\%$) over $-40^{\circ}C$ to $125^{\circ}C$
- V_{OUT} Low Temperature Coefficient
- Output Current up to 20mA
- Low ($< 160\mu A$) Quiescent Current
- Stable without Compensation Capacitor
- Available with Compact, Surface Mount SOT-23 Package
- Pb-Free, Halogen Free, RoHS/WEEE compliant product

Applications

- Bias Supplies
- High Accuracy Micropower Supplies
- Data Acquisition Systems
- Medical Devices
- Portable Battery Powered Equipment
- Test Equipment
- Automotive and Industrial

Description

The SC4437 is a low power precision series bandgap reference device. It accepts wide input voltage range $V_{OUT} + 0.9V$ to 28V and generates stable output voltage with superior accuracy and low drift over operating temperatures. The SC4437 is ideal for battery powered systems where there can be wide variations in supply voltage and a need to minimize power dissipation.

The SC4437 is able to supply up to 20mA output current with excellent line and load regulation characteristics. The output compensation capacitor is optional. It provides user the flexibility of compact, low cost design or further noise performance enhanced design.

The SC4437 is available in a compact 3-lead surface mount SOT-23 package.

Typical Application Circuit

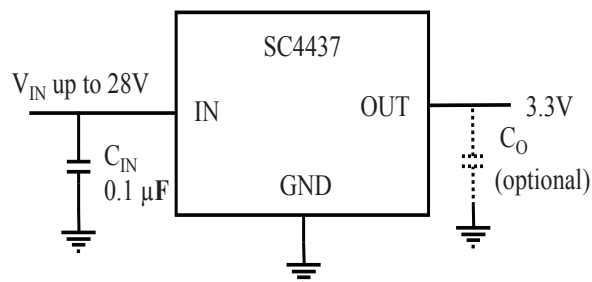

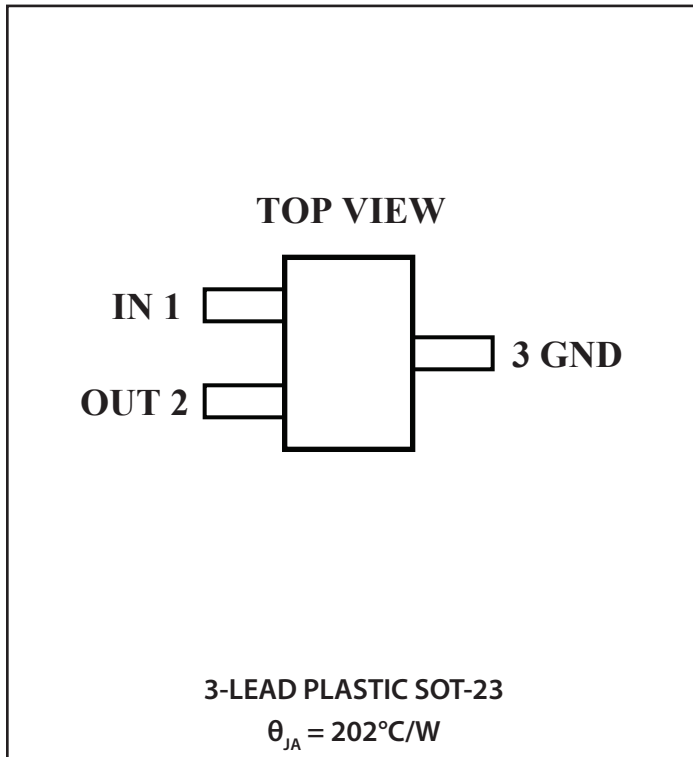
Pin Configuration

Ordering Information

Device	Package
SC4437SK-3.3TRT	3-Lead Plastic SOT-23
SC4437EVB	Evaluation Board

Notes:

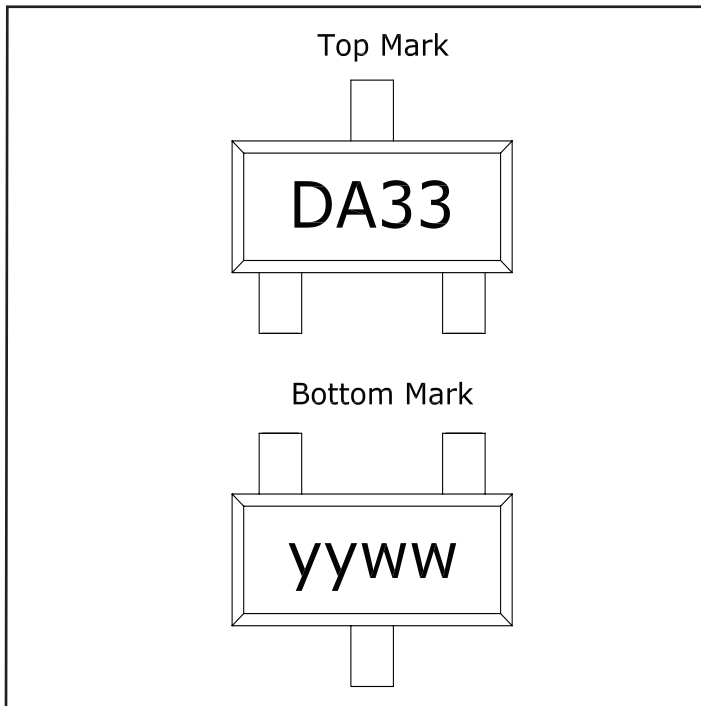
- (1) Available in tape and reel only. A reel contains 3,000 devices.
- (2) Pb-Free, Halogen Free, RoHS/WEEE compliant product.

Marking Information

Absolute Maximum Ratings

V_{IN} Voltage	30V
Reverse Voltage	-15V
Output Short Circuit Duration	Indefinite ⁽¹⁾
Lead Temperature (Soldering) 10 seconds ⁽²⁾	260°C
ESD Rating	2kV

Recommended Operating Conditions

V_{IN} Voltage	4.2 to 28V
Maximum Output Current	20mA
Temperature Range	-40°C to 125°C

Thermal Information

Thermal Resistance, Junction to Ambient ⁽³⁾	202 °C/W
Maximum Junction Temperature	+150°C
Storage Temperature Range ⁽⁴⁾	-65°C to +150°C

Exceeding the above specifications may result in permanent damage to the device or device malfunction. Operation outside of the parameters specified in the Electrical Characteristics section is not recommended.

NOTES:

- (1) For $V_{IN} \leq 10V$.
- (2) Compatible for Wave Soldering and IR Reflow.
- (3) Calculated from package in still air, mounted to 3" x 4.5", 4 layer FR4 PCB per JESD51 standards.
- (4) If the part is stored outside of the specified temperature range, the output may drift.

Electrical Characteristics

Unless specified: $V_{IN} = V_{OUT} + 2.5V$, $I_{OUT} = 0$, $C_{IN} = 0.1\mu F$, $C_O = 0\mu F$, $-40^\circ C < T_A = T_J < 125^\circ C$

Parameter	Symbol	Conditions	Min	Typ	Max	Units	
INPUT							
Input Voltage Range	V_{IN}	Refer to Line Regulation Spec.	4.2		28	V	
Drop Out Voltage	$V_{IN} - V_{OUT}$	$I_{OUT} = 0$		0.6	0.9	V	
		$I_{OUT} = 10mA$, $T_A = 25^\circ C$		0.9	1.28	V	
		$I_{OUT} = 10mA$			1.38	V	
Leakage Current for Input Voltage Reverse Connection	I_{REV}	$V_{IN} = -15V$		2	6	μA	
Quiescent Current	I_Q	$T_A = 25^\circ C$		110	180	μA	
					220	μA	
OUTPUT							
Output Voltage	V_{OUT}	$T_J = 25^\circ C$		3.3		V	
Output Voltage Accuracy	%	$0^\circ C \leq T_J < 100^\circ C$, $0mA < I_{OUT} \leq 20mA$, $4.2V \leq V_{IN} \leq 28V$	-1		1	%	
Line Regulation	dV_{OUT}/dV_{IN}	$V_{OUT} + 0.9V \leq V_{IN} \leq V_{OUT} + 2.5V$	$T_A = 25^\circ C$		100	500	ppm/V
						3300	ppm/V
		$V_{OUT} + 2.5V \leq V_{IN} \leq 28V$	$T_A = 25^\circ C$		50	100	ppm/V
							300

Electrical Characteristics (continued)

 Unless specified: $V_{IN} = V_{OUT} + 2.5V$, $I_{OUT} = 0$, $C_{IN} = 0.1\mu F$, $C_O = 0\mu F$, $-40^\circ C < T_A = T_J < 125^\circ C$

Parameter	Symbol	Conditions	Min	Typ	Max	Units	
Load Regulation	dV_{OUT}/dI_{LOAD}	$I_{OUT} = 100\mu A$	$T_A = 25^\circ C$		3000	4000	ppm/mA
						6000	ppm/mA
		$I_{OUT} = 10mA$	$T_A = 25^\circ C$		100	150	ppm/mA
						250	ppm/mA
		$I_{OUT} = 20mA$	$T_A = 25^\circ C$		75	100	ppm/mA
						150	ppm/mA
Output Voltage Temperature Coefficient	dV_{OUT}/dT	$0^\circ C \leq T_J < 105^\circ C$		80	120	ppm/ $^\circ C$	
Output Short Circuit Current	I_{SC}	Short V_{OUT} to GND, $T_A = 25^\circ C$		55		mA	
DYNAMIC							
Turn-On Settling Time	T_{ON}	$V_{IN} > V_{OUT} + 2.5V$, V_{OUT} settles to $\pm 0.05\%$ of final value			3 ⁽¹⁾	ms	

NOTES:
(1) Guaranteed by design.

Pin Descriptions

Pin #	Pin Name	Pin Function
1	V _{IN}	Input supply voltage for the precision voltage reference.
2	V _{OUT}	Output voltage.
3	GND	Ground connection for the circuit.

Typical Waveforms

Minimum Input - Output Voltage Differential

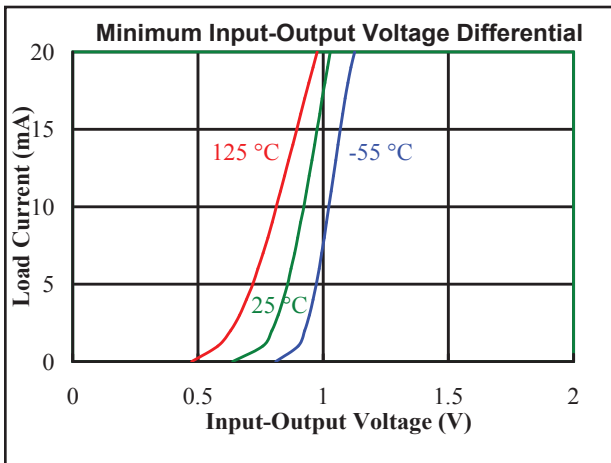

Supply Current vs Input Voltage

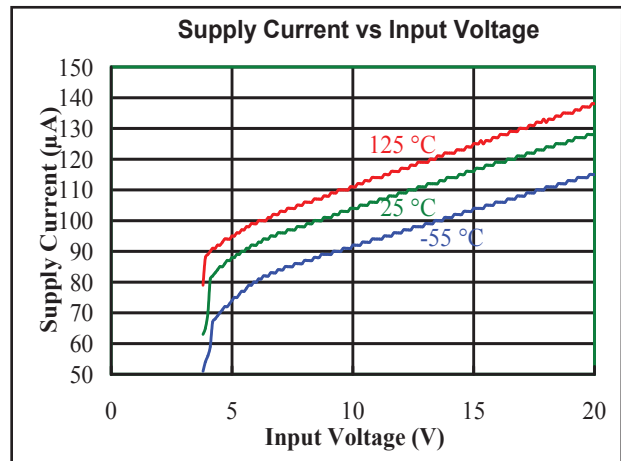

Load Regulation - Sourcing

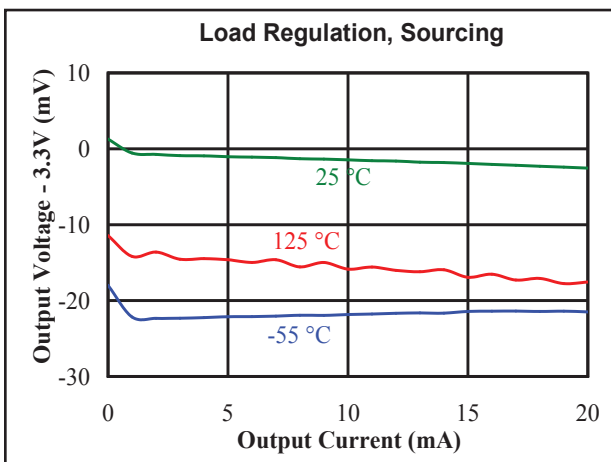

Load Regulation - Sinking

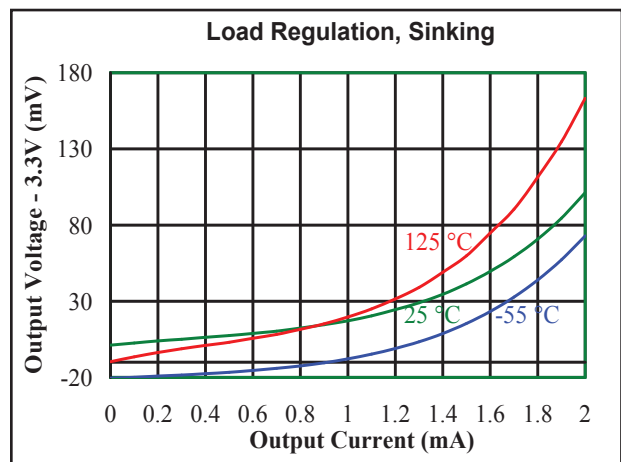

Line Regulation

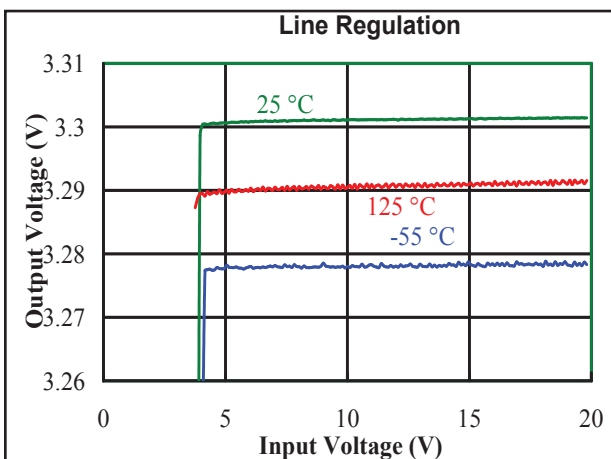

Power Supply Rejection Ratio vs Frequency

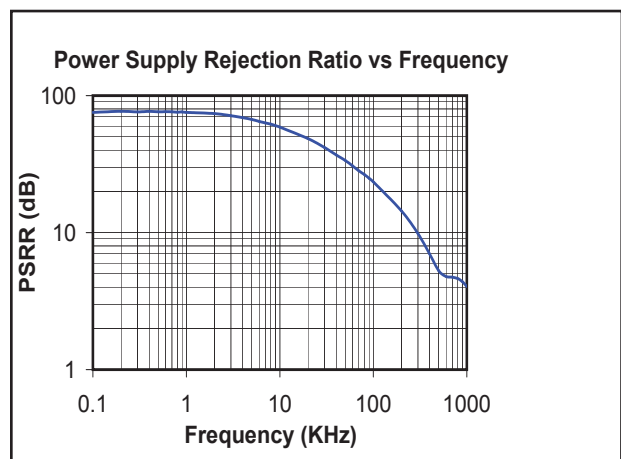

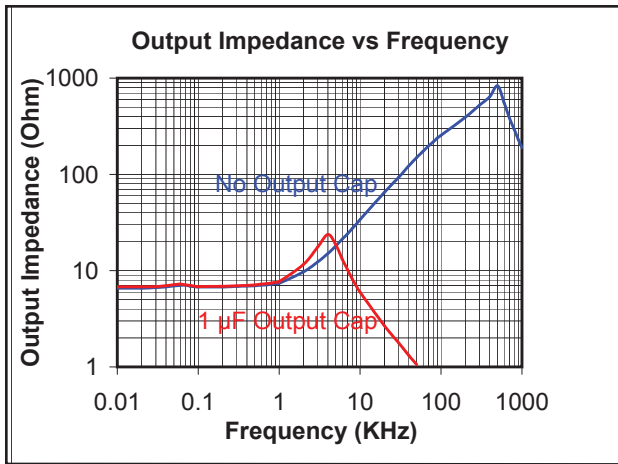
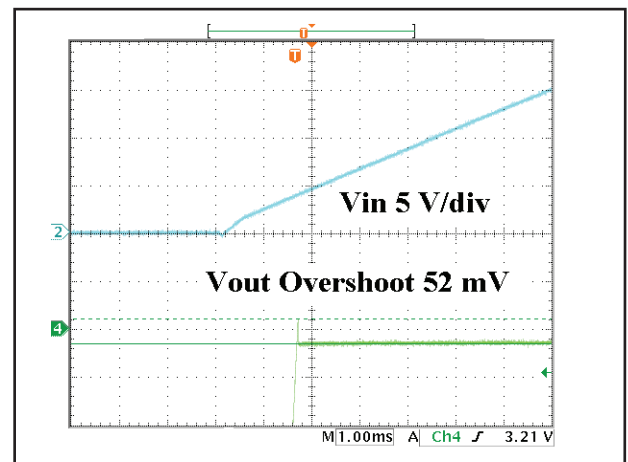
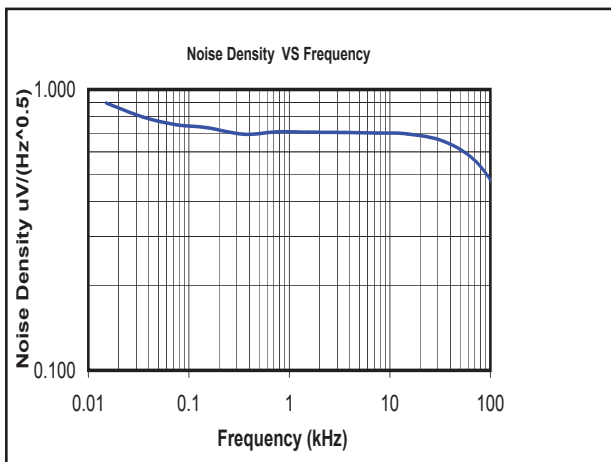
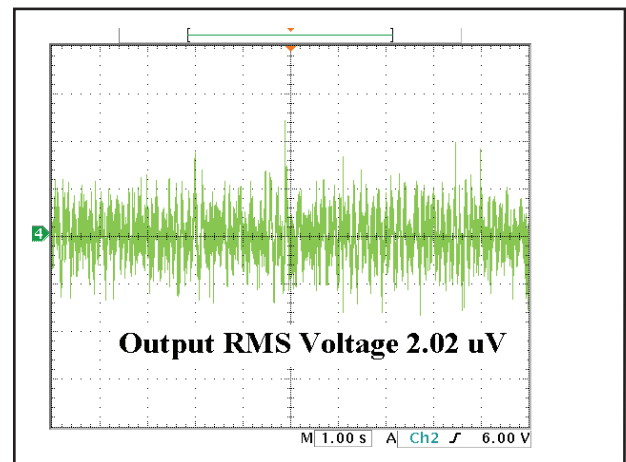
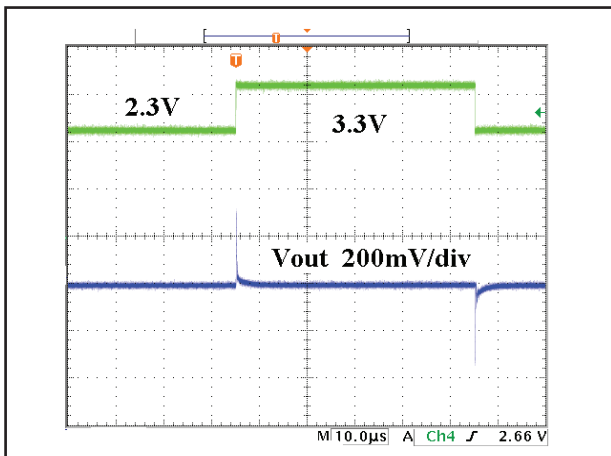
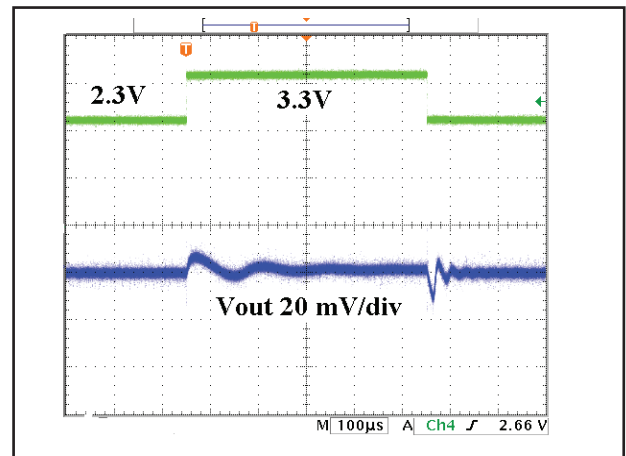
Typical Waveforms (Continued)
Output Impedance

Start Up with Input Voltage 20 V

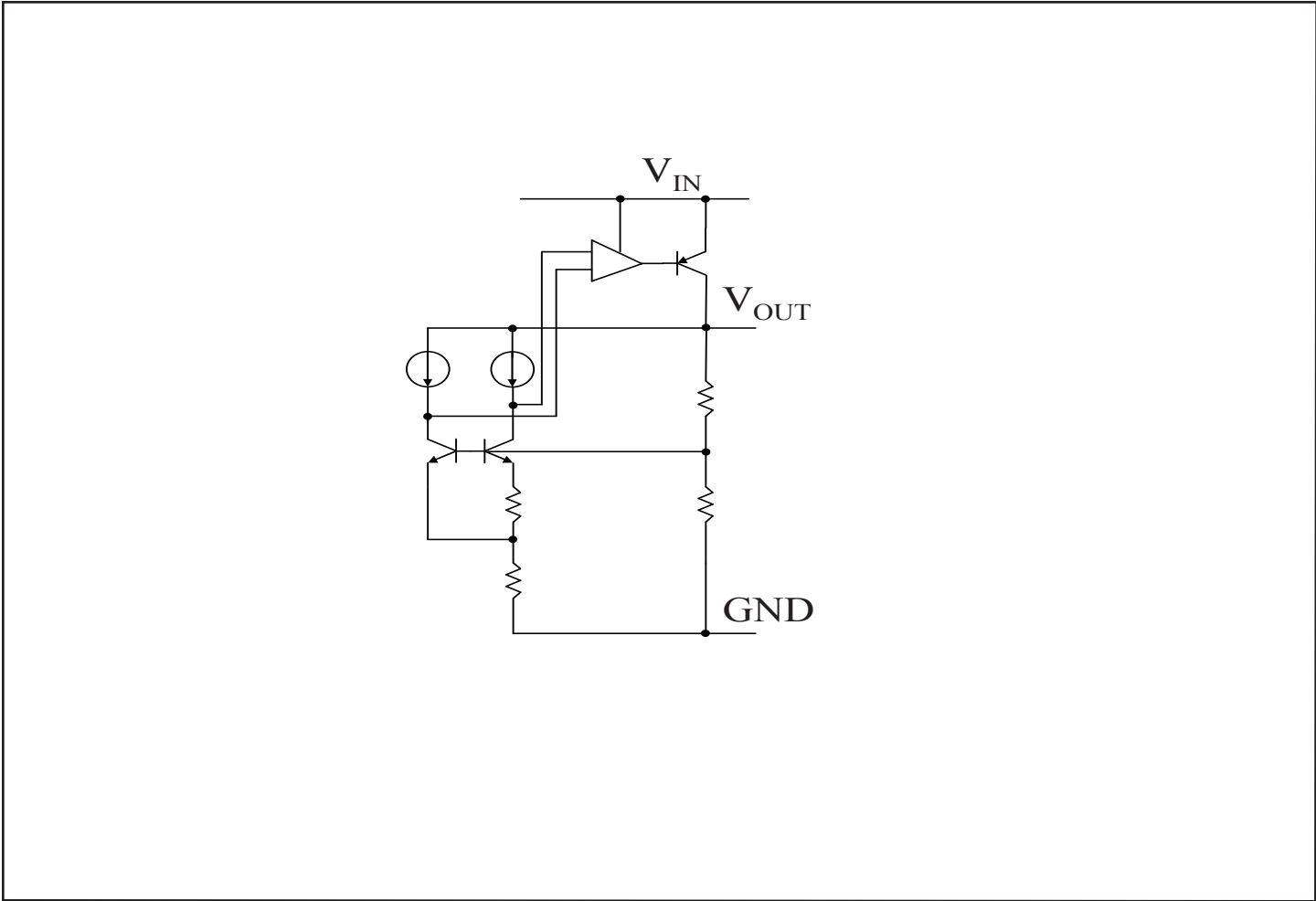
Output Noise Performance 10 Hz to 100 kHz

Output Noise Waveform 0.1Hz to 10 Hz

1 mA Transient Response without Output Cap

1 mA Transient Response with 1 μ F Output Cap

Block Diagram



Applications Information

Advantage Over Shunt References

The SC4437 is a low power precision series voltage reference. The series reference has major advantages over shunt references when the load current has variations and the reference is powered by a battery. A shunt reference requires a resistance to connect the input and the output. This resistance will be designed to consume the maximum load current. When the actual load current is smaller than the maximum load current, the difference will be consumed by the reference. This behavior not only reduce efficiency but also increase the thermal stress on the device, thus is not desirable. On the contrary, the series reference consumes the same current as the load. When there is no load current required, the device itself consumes very little current (in the scale of 10s of μA).

Precision Reference Over Wide Input Voltage Range, Load Conditions and Operating Temperatures

The SC4437 can maintain 1% precision regulation over wide load range, operating temperature condition and input voltage range. To provide 3.3V output voltage, the load can range from 0 to 20mA; the temperature can range from $-40\text{ }^{\circ}\text{C}$ to $125\text{ }^{\circ}\text{C}$; the input voltage can range from $V_{\text{OUT}} + 0.9\text{V}$ to 28V, depending on the load and temperature conditions. The input voltage range should be selected based on the drop out voltage specification. Although the SC4437 can maintain tight regulation over wide operating conditions, attention should be paid to the thermal stress of the device. For example, with the input voltage of 28V and the load current of 20mA, the power consumption on the device is

$$P = (28\text{V} - 3.3\text{V}) * 0.02\text{A} = 0.494\text{W}$$

With the thermal resistance of $202\text{ }^{\circ}\text{C}/\text{W}$, the power consumption on the chip gives an ambient to junction temperature increase of $99.8\text{ }^{\circ}\text{C}$. If the ambient temperature is higher than $25\text{ }^{\circ}\text{C}$, then the junction temperature will be higher than $125\text{ }^{\circ}\text{C}$, thus should be avoided.

Input and Output Capacitances

The SC4437 is stable with or without output capacitors under all load conditions. Adding output capacitances can

improve the dynamic response under load transient. In order to obtain optimum performance under load transient, it is recommended that a $0.1\text{ }\mu\text{F}$ ceramic capacitor placed at the input and a $1\text{ }\mu\text{F}$ (and up) ceramic capacitor placed at the output.

Reverse Battery Connection Protection

The SC4437 has reverse battery connection protection. When the input and ground is reversely connected, the leakage current from the input is very small (maximum $6\text{ }\mu\text{A}$), protecting both the battery and the device itself.

Load Transient Responses

The following figure shows the circuit setup to test the 1 mA load transient response.

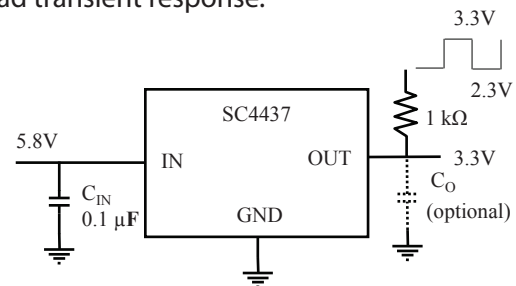

Without output capacitance, the transient response is shown below.

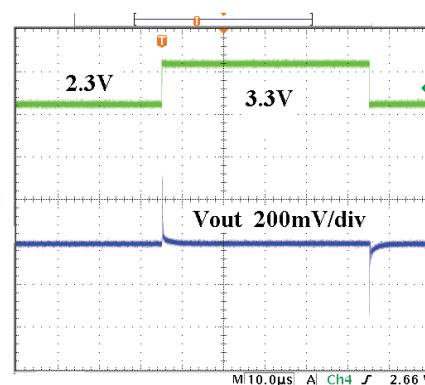

The high overshoot is due to the high resistance at high frequency without output capacitance.

With $1\text{ }\mu\text{F}$ capacitance, the transient response is improved significantly. The figure below shows the 1mA transient response with $1\text{ }\mu\text{F}$ capacitance at the output.

Applications Information (continued)

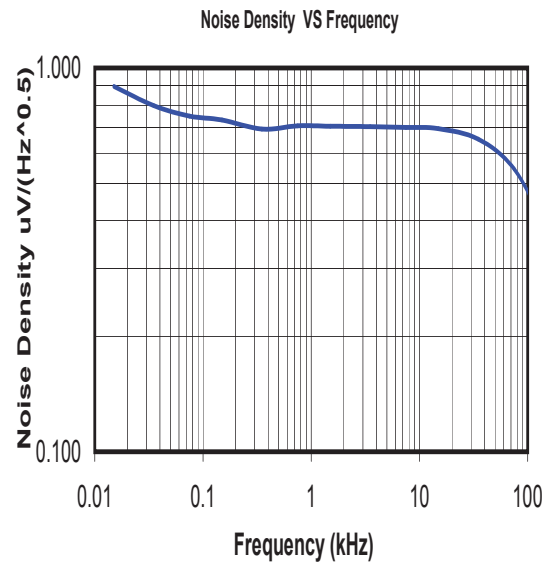
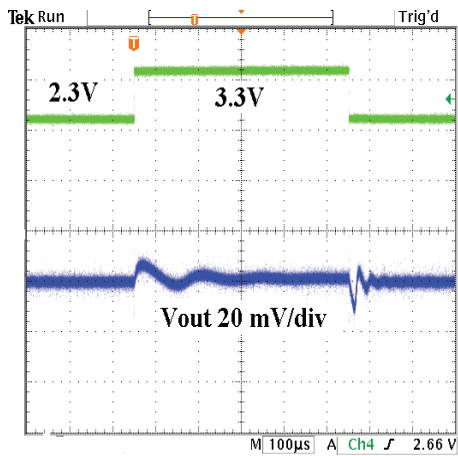

Start Up

With the input voltage 5.8V, the device shows very small start up overshoot, as shown by the figure below.

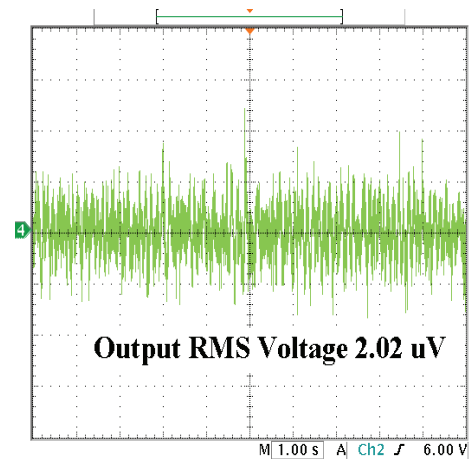
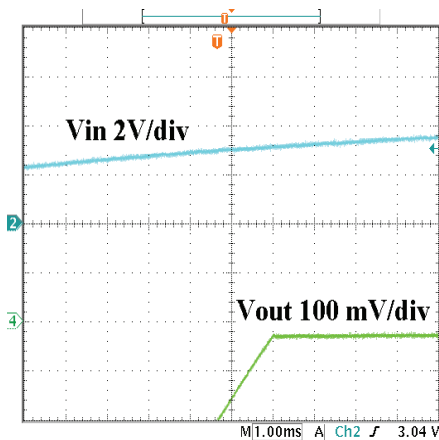

Low Noise Operation

The SC4437 is a low noise reference. The noise is measured with high gain amplification and band filtering. Without any output capacitor the noise level is measured to be around $0.7 \mu\text{V}/\sqrt{\text{Hz}}$ from 0 to 100 kHz. With output capacitor the noise level will be significantly lower. The following figure shows the noise measurement result under room temperature without output capacitor from 10Hz to 100kHz and the scope picture of noise measurement result from 0.1 Hz to 10 Hz.

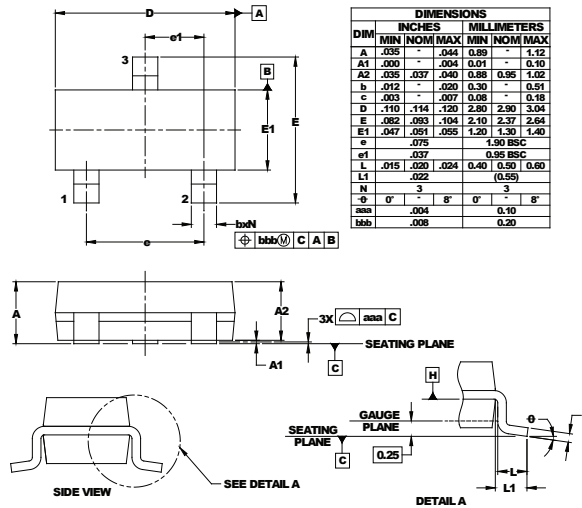
Outline Drawing – SOT-23 3L

NOTES:

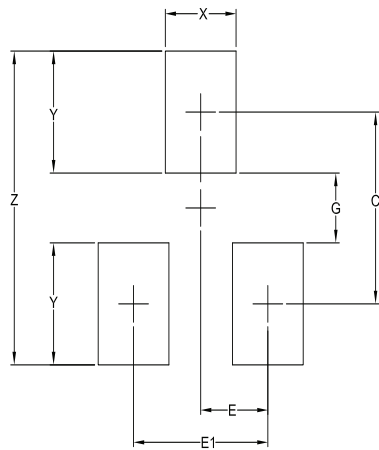
1. CONTROLLING DIMENSIONS ARE IN MILLIMETERS (ANGLES IN DEGREES).
2. DATUMS **-A-** AND **-B-** TO BE DETERMINED AT DATUM PLANE **-H-**
3. DIMENSIONS "E1" AND "D" DO NOT INCLUDE MOLD FLASH, PROTRUSIONS OR GATE BURRS.

Land Pattern – SOT-23

(RECOMMENDED LAND PATTERN FOR REFLOW SOLDERING)

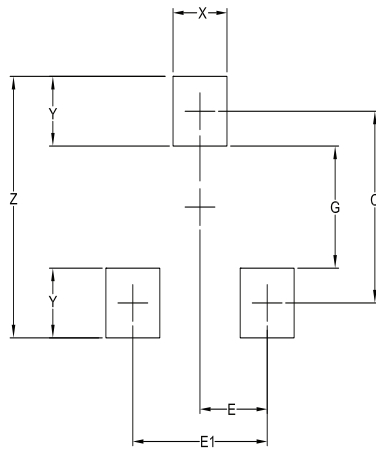
DIMENSIONS		
DIM	INCHES	MILLIMETERS
C	(.087)	(2.20)
E	.037	0.95
E1	.075	1.90
G	.031	0.80
X	.039	1.00
Y	.055	1.40
Z	.141	3.60



(RECOMMENDED LAND PATTERN FOR WAVE SOLDERING)

DIMENSIONS		
DIM	INCHES	MILLIMETERS
C	(.087)	(2.20)
E	.037	0.95
E1	.075	1.90
G	.055	1.40
X	.030	0.76
Y	.032	0.80
Z	.118	3.00

NOTES:

1. THIS LAND PATTERN IS FOR REFERENCE PURPOSES ONLY. CONSULT YOUR MANUFACTURING GROUP TO ENSURE YOUR COMPANY'S MANUFACTURING GUIDELINES ARE MET.
2. REFERENCE IPC-SM-782A.

Contact Information

Semtech Corporation
 Power Management Products Division
 200 Flynn Road, Camarillo, CA 93012
 Phone: (805) 498-2111 Fax: (805) 498-3804

www.semtech.com



Компания «ЭлектроПласт» предлагает заключение долгосрочных отношений при поставках импортных электронных компонентов на взаимовыгодных условиях!

Наши преимущества:

- Оперативные поставки широкого спектра электронных компонентов отечественного и импортного производства напрямую от производителей и с крупнейших мировых складов;
- Поставка более 17-ти миллионов наименований электронных компонентов;
- Поставка сложных, дефицитных, либо снятых с производства позиций;
- Оперативные сроки поставки под заказ (от 5 рабочих дней);
- Экспресс доставка в любую точку России;
- Техническая поддержка проекта, помощь в подборе аналогов, поставка прототипов;
- Система менеджмента качества сертифицирована по Международному стандарту ISO 9001;
- Лицензия ФСБ на осуществление работ с использованием сведений, составляющих государственную тайну;
- Поставка специализированных компонентов (Xilinx, Altera, Analog Devices, Intersil, Interpoint, Microsemi, Aeroflex, Peregrine, Syfer, Eurofarad, Texas Instrument, Miteq, Cobham, E2V, MA-COM, Hittite, Mini-Circuits, General Dynamics и др.);

Помимо этого, одним из направлений компании «ЭлектроПласт» является направление «Источники питания». Мы предлагаем Вам помощь Конструкторского отдела:

- Подбор оптимального решения, техническое обоснование при выборе компонента;
- Подбор аналогов;
- Консультации по применению компонента;
- Поставка образцов и прототипов;
- Техническая поддержка проекта;
- Защита от снятия компонента с производства.



Как с нами связаться

Телефон: 8 (812) 309 58 32 (многоканальный)

Факс: 8 (812) 320-02-42

Электронная почта: org@eplast1.ru

Адрес: 198099, г. Санкт-Петербург, ул. Калинина, дом 2, корпус 4, литера А.