

### Features

- 0.8 inch character height.
- Low current operation.
- High contrast and light output.
- Common cathode and common anode available.
- Easy mounting on P.C. boards or sockets.
- Mechanically rugged.
- Standard : gray face, white segment.
- RoHS compliant.

### Description

The Super Bright Red source color devices are made with Gallium Aluminum Arsenide Red Light Emitting Diode.

### Package Dimensions& Internal Circuit Diagram

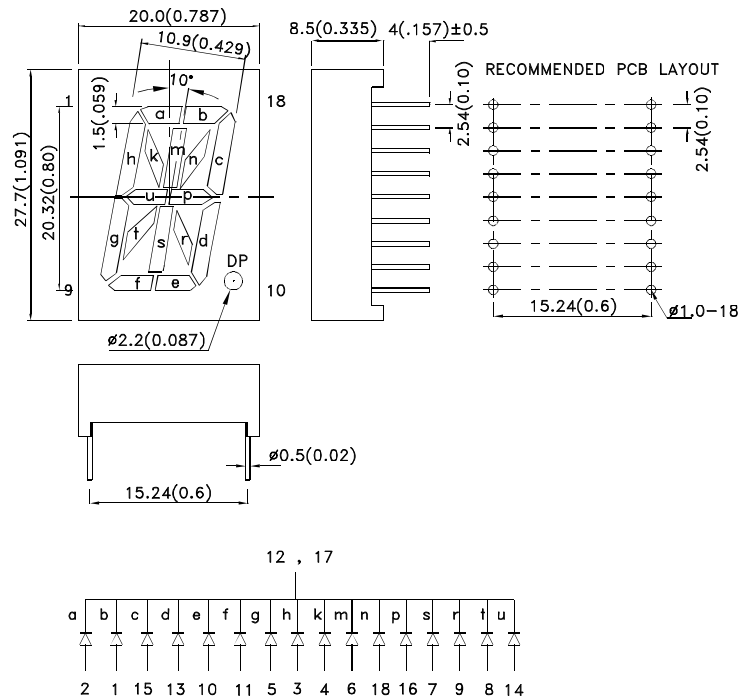

### Notes:

1. All dimensions are in millimeters (inches), Tolerance is ±0.25(0.01") unless otherwise noted.
2. The specifications, characteristics and technical data described in the datasheet are subject to change without prior notice.



## Selection Guide

Part No.	Dice	Lens Type	Iv (ucd) [1] @ 10mA		Description
			Min.	Typ.	
PSC08-12SRWA	Super Bright Red (GaAlAs)	White Diffused	14000	27000	Common Cathode

Note:

1. Luminous intensity/ luminous Flux: +/-15%.

## Electrical / Optical Characteristics at TA=25°C

Symbol	Parameter	Device	Typ.	Max.	Units	Test Conditions
$\lambda_{peak}$	Peak Wavelength	Super Bright Red	660		nm	I <sub>F</sub> =20mA
$\lambda_D$ [1]	Dominant Wavelength	Super Bright Red	640		nm	I <sub>F</sub> =20mA
$\Delta\lambda_{1/2}$	Spectral Line Half-width	Super Bright Red	20		nm	I <sub>F</sub> =20mA
C	Capacitance	Super Bright Red	45		pF	V <sub>F</sub> =0V;f=1MHz
V <sub>F</sub> [2]	Forward Voltage	Super Bright Red	1.85	2.5	V	I <sub>F</sub> =20mA
I <sub>R</sub>	Reverse Current	Super Bright Red		10	uA	V <sub>R</sub> =5V

Notes:

1. Wavelength: +/-1nm.

2. Forward Voltage: +/-0.1V.

## Absolute Maximum Ratings at TA=25°C

Parameter	Super Bright Red	Units
Power dissipation	75	mW
DC Forward Current	30	mA
Peak Forward Current [1]	155	mA
Reverse Voltage	5	V
Operating / Storage Temperature	-40°C To +85°C	
Lead Solder Temperature[2]	260°C For 3-5 Seconds	

Notes:

1. 1/10 Duty Cycle, 0.1ms Pulse Width.

2. 2mm below package base.



## Super Bright Red

## PSC08-12SRWA

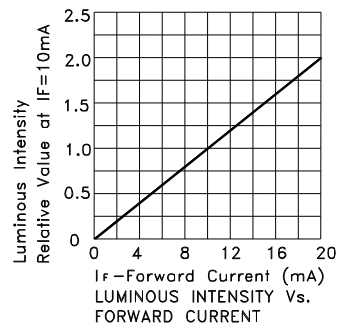

**PACKING & LABEL SPECIFICATIONS**

**PSC08-12SRWA**

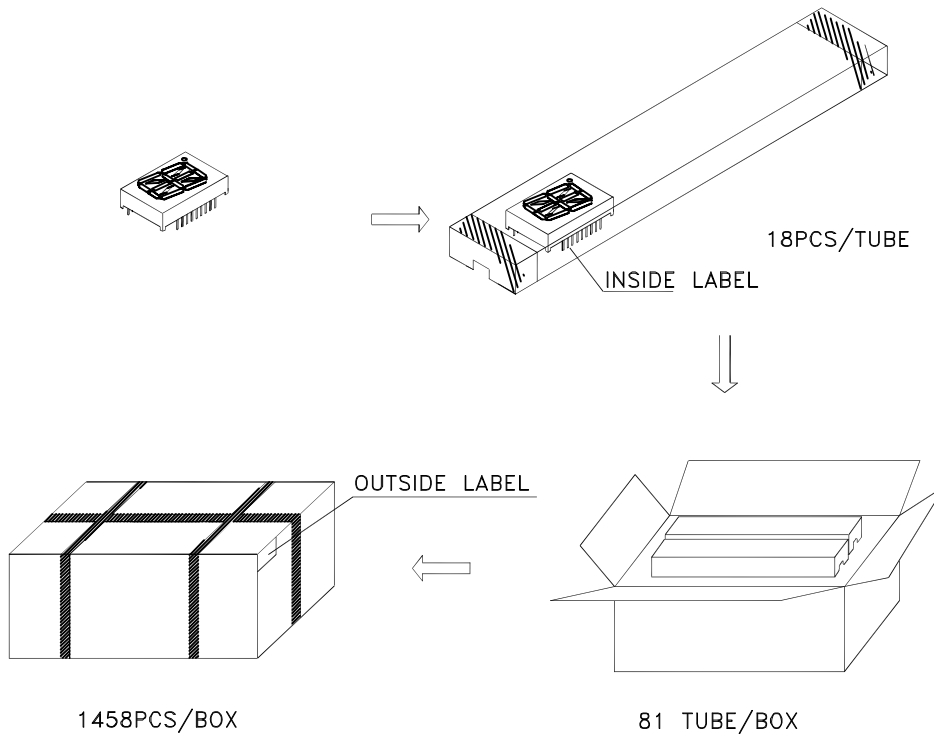

Inside Label On IC-tube

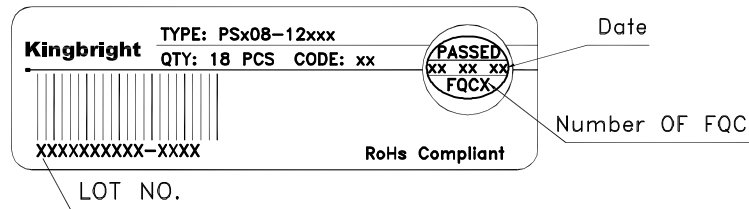

Outside Label On Box

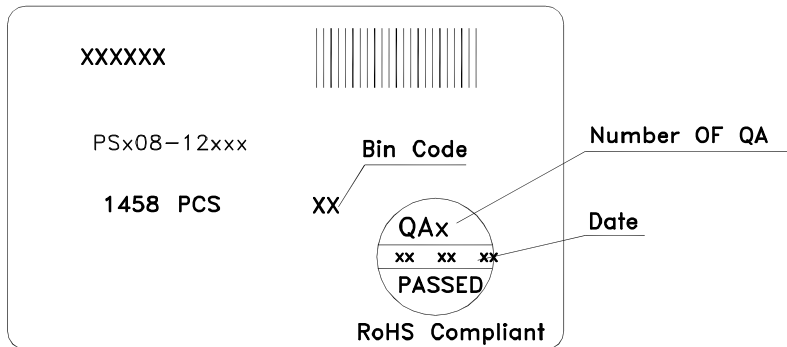

## THROUGH HOLE DISPLAY MOUNTING METHOD

### Lead Forming

Do not bend the component leads by hand without proper tools.  
The leads should be bent by clinching the upper part of the lead firmly such that the bending force is not exerted on the plastic body.



### Installation

- 1.The installation process should not apply stress to the lead terminals.
- 2.When inserting for assembly, ensure the terminal pitch matches the substrate board's hole pitch to prevent spreading or pinching the lead terminals.



## DISPLAY SOLDERING CONDITIONS

Wave Soldering Profile For Lead-free Through-hole LED.

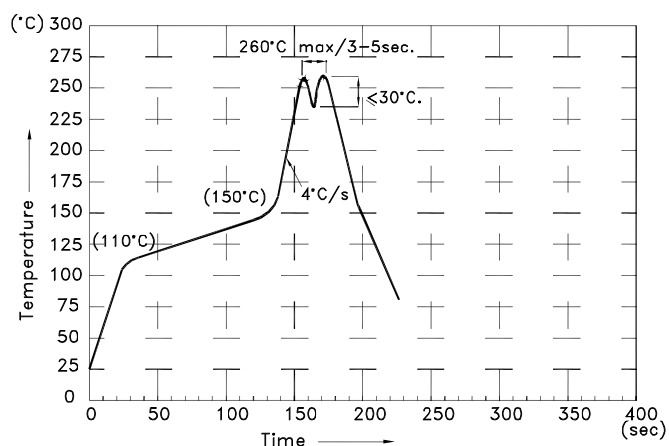

#### NOTES:

- 1.Recommend the wave temperature 245°C~260°C.The maximum soldering temperature should be less than 260°C.
- 2.Do not apply stress on epoxy resins when temperature is over 85°C.
- 3.The soldering profile apply to the lead free soldering (Sn/Cu/Ag alloy).
- 4.During wave soldering , the PCB top-surface temperature should be kept below 105°C
- 5.No more than once.

## Soldering General Notes:

- a. Through-hole displays are incompatible with reflow soldering.
- b. If components will undergo multiple soldering processes, or other processes where the components may be subjected to intense heat, please check with Kingbright for compatibility.

## CLEANING

1. Mild "no-clean" fluxes are recommended for use in soldering.
2. If cleaning is required, Kingbright recommends to wash components with water only. Do not use harsh organic solvents for cleaning, because they may damage the plastic parts. And the devices should not be washed for more than one minute.

## CIRCUIT DESIGN NOTES

1. Protective current-limiting resistors may be necessary to operate the Displays.
2. LEDs mounted in parallel should each be placed in series with its own current-limiting resistor.

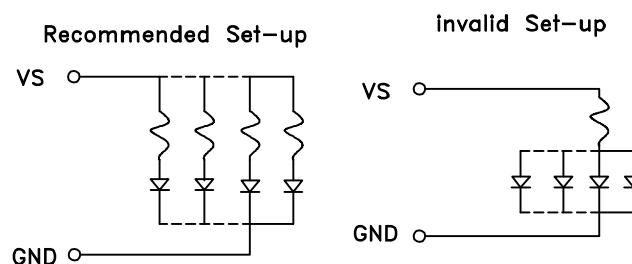



Компания «ЭлектроПласт» предлагает заключение долгосрочных отношений при поставках импортных электронных компонентов на взаимовыгодных условиях!

Наши преимущества:

- Оперативные поставки широкого спектра электронных компонентов отечественного и импортного производства напрямую от производителей и с крупнейших мировых складов;
- Поставка более 17-ти миллионов наименований электронных компонентов;
- Поставка сложных, дефицитных, либо снятых с производства позиций;
- Оперативные сроки поставки под заказ (от 5 рабочих дней);
- Экспресс доставка в любую точку России;
- Техническая поддержка проекта, помощь в подборе аналогов, поставка прототипов;
- Система менеджмента качества сертифицирована по Международному стандарту ISO 9001;
- Лицензия ФСБ на осуществление работ с использованием сведений, составляющих государственную тайну;
- Поставка специализированных компонентов (Xilinx, Altera, Analog Devices, Intersil, Interpoint, Microsemi, Aeroflex, Peregrine, Syfer, Eurofarad, Texas Instrument, Miteq, Cobham, E2V, MA-COM, Hittite, Mini-Circuits, General Dynamics и др.);

Помимо этого, одним из направлений компании «ЭлектроПласт» является направление «Источники питания». Мы предлагаем Вам помощь Конструкторского отдела:

- Подбор оптимального решения, техническое обоснование при выборе компонента;
- Подбор аналогов;
- Консультации по применению компонента;
- Поставка образцов и прототипов;
- Техническая поддержка проекта;
- Защита от снятия компонента с производства.



#### Как с нами связаться

**Телефон:** 8 (812) 309 58 32 (многоканальный)

**Факс:** 8 (812) 320-02-42

**Электронная почта:** [org@eplast1.ru](mailto:org@eplast1.ru)

**Адрес:** 198099, г. Санкт-Петербург, ул. Калинина, дом 2, корпус 4, литера А.