

## LISA2-O-90-CLIP

~20° x 50° turned oval beam optimized for CREE XP-E. 6.8 mm high variant with clip installation.

### TECHNICAL SPECIFICATIONS:

Dimensions	Ø 9.9 mm
Height	6.8 mm
Fastening	glue, clips
ROHS compliant	yes ⓘ

### MATERIAL SPECIFICATIONS:

Component	Type	Material	Colour	Finish
LISA2-O-XP	Single lens	PMMA	clear	
LISA2-HLD-CLIP16-XP	Holder	PC	black	



### ORDERING INFORMATION:

Component		Qty in box	MOQ	MPQ	Box weight (kg)
FP11856_LISA2-O-90-CLIP	Single lens	2000		100	1.4
» Box size:					

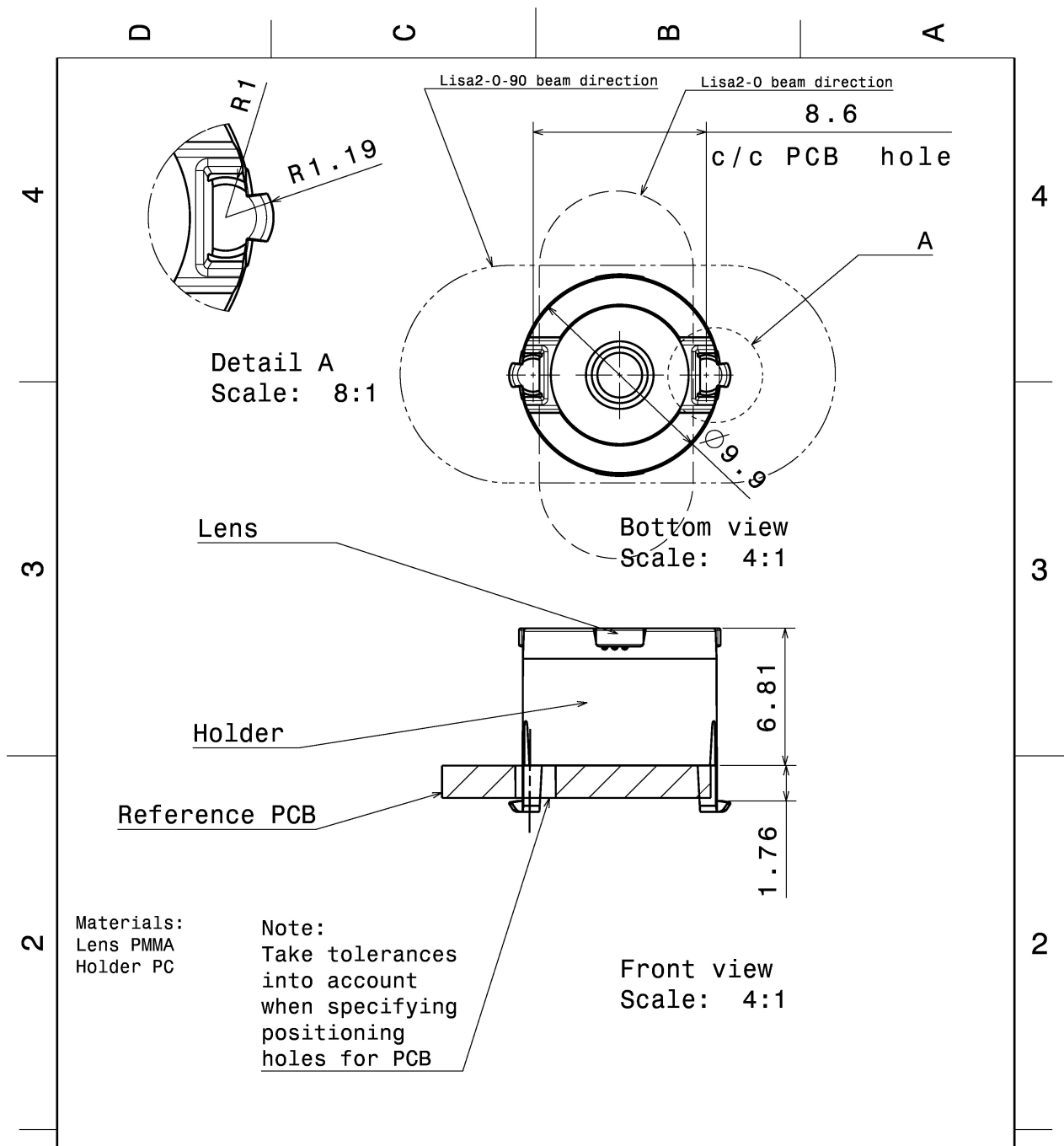

This drawing is our property. It can't be reproduced or communicated without our written agreement.		<b>LEDiL</b>		Ledil Oy Tehdaskatu 13 FIN-24100 SALO Finland	
<b>DRAWING TITLE</b>					
DRAWN BY ch		DATE 20.7.2011		Datasheet Lisa2-clip16-XP series Assy	
CHECKED BY sn	DATE 20.7.2011	SIZE A4	DRAWING NUMBER		REV 2
DESIGNED BY hh	DATE 19.10.2009	SCALE 4:1	WEIGHT (g)	SHEET 1/1	

#### PHOTOMETRIC DATA (MEASURED):



LED XP-E  
 FWHM 48.0 + 18.0°  
 Efficiency 83 %  
 LEDs/each optic 1  
 Light colour White  
 Required components:

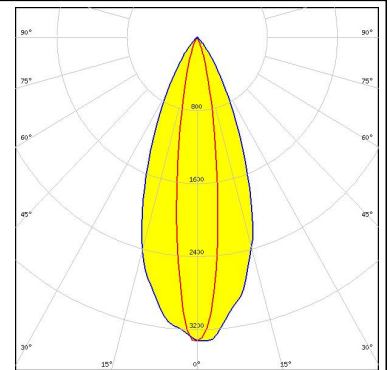

LED XP-G  
 FWHM 48.0 + 18.0°  
 Efficiency 86 %  
 LEDs/each optic 1  
 Light colour White  
 Required components:



LED LUXEON C  
 FWHM 17.0 + 47.0°  
 Efficiency 80 %  
 Peak intensity 2.5 cd/lm  
 LEDs/each optic 1  
 Light colour White  
 Required components:

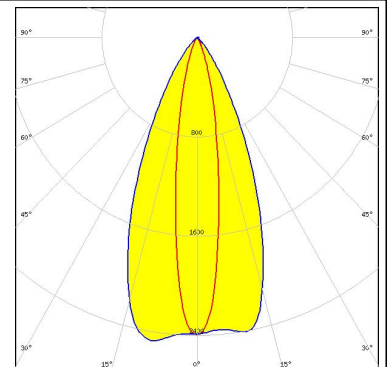
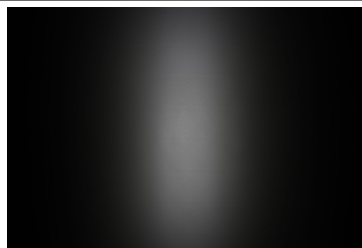

LED LUXEON Z ES  
 FWHM 18.0 + 49.0°  
 Efficiency 80 %  
 Peak intensity 2.2 cd/lm  
 LEDs/each optic 1  
 Light colour White  
 Required components:

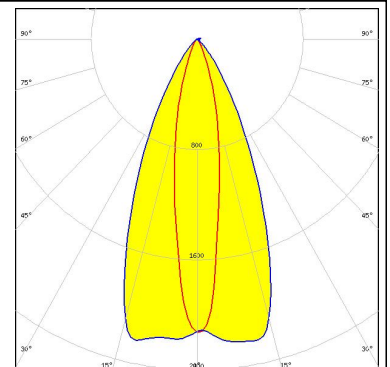
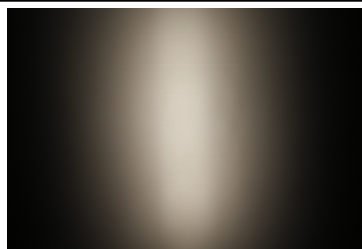

## PHOTOMETRIC DATA (MEASURED):

**OSRAM**  
Opto Semiconductors

LED SFH 4170S  
FWHM 13.0 + 46.0°  
Efficiency %  
LEDs/each optic 1  
Light colour IR  
Required components:

**OSRAM**  
Opto Semiconductors

LED SFH 4180S  
FWHM 13.0 + 48.0°  
Efficiency %  
LEDs/each optic 1  
Light colour IR  
Required components:

#### PHOTOMETRIC DATA (SIMULATED):

#### CREE

LED XQ-E HD  
FWHM 40.0 + 13.0°  
Efficiency 86 %  
Peak intensity 3.5 cd/lm  
LEDs/each optic 1  
Light colour White  
Required components:

#### CREE

LED XQ-E HI  
FWHM 46.0 + 11.0°  
Efficiency 83 %  
Peak intensity 3.8 cd/lm  
LEDs/each optic 1  
Light colour White  
Required components:

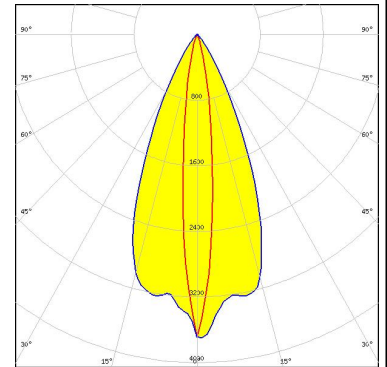

#### SHARP

LED Double Dome (GM2BB)  
FWHM 48.0 + 20.0°  
Efficiency %  
LEDs/each optic 1  
Light colour White  
Required components:

#### GENERAL INFORMATION:

NOTE: The typical beam angle will be changed by different color, chip size and chip position tolerance. The typical total beam angle is the full angle measured where the luminous intensity is half of the peak value.

#### MATERIALS:

As part of our continuous research and improvement processes, and to ensure the best possible quality and availability of our products, LEDiL reserves the right to change material grades without notice.

#### PRODUCT DATA USER AGREEMENT AND DISCLAIMER:

The measured data in the provided downloadable LEDiL Product Datasheets and Mechanical 2D-Drawings is rounded and provided as reference for planning. LEDiL Oy's optical specifications have been verified by conducting performance testing of the products in accordance with the company's quality system. The reported data are averaged results of multiple measurements with typical variation. LEDiL Oy reserves the right to without prior notification make changes and improvements to its products.

LEDiL Oy assumes neither warranty, nor guarantee nor any other liability of any kind for the contents and correctness of the provided data. The provided data has been generated with highest diligence but the provided data may in reality not represent the complete possible variation range of all intrinsic parameters. Therefore, in certain cases a deviation from the provided data could occur.

LEDiL Oy reserves the right to undertake technical changes of its products without further notification which could lead to changes in the provided data. LEDiL Oy assumes no liability of any kind for the possible deviation from any provided data or any other damage resulting from the usage of the provided data.

The user agrees to this disclaimer and user agreement with the download or usage of the provided files.

#### LEDiL Oy

Joensuunkatu 13  
FI-24240 SALO  
Finland

#### LEDiL Inc.

228 West Page Street  
Suite D  
Sycamore IL 60178  
USA

#### Local sales and technical support

[www.ledil.com/  
where\\_to\\_buy](http://www.ledil.com/where_to_buy)

#### Shipping locations

Salo, Finland  
Hong Kong, China

#### Distribution Partners

[www.ledil.com/  
where\\_to\\_buy](http://www.ledil.com/where_to_buy)



Компания «ЭлектроПласт» предлагает заключение долгосрочных отношений при поставках импортных электронных компонентов на взаимовыгодных условиях!

Наши преимущества:

- Оперативные поставки широкого спектра электронных компонентов отечественного и импортного производства напрямую от производителей и с крупнейших мировых складов;
- Поставка более 17-ти миллионов наименований электронных компонентов;
- Поставка сложных, дефицитных, либо снятых с производства позиций;
- Оперативные сроки поставки под заказ (от 5 рабочих дней);
- Экспресс доставка в любую точку России;
- Техническая поддержка проекта, помощь в подборе аналогов, поставка прототипов;
- Система менеджмента качества сертифицирована по Международному стандарту ISO 9001;
- Лицензия ФСБ на осуществление работ с использованием сведений, составляющих государственную тайну;
- Поставка специализированных компонентов (Xilinx, Altera, Analog Devices, Intersil, Interpoint, Microsemi, Aeroflex, Peregrine, Syfer, Eurofarad, Texas Instrument, Miteq, Cobham, E2V, MA-COM, Hittite, Mini-Circuits, General Dynamics и др.);

Помимо этого, одним из направлений компании «ЭлектроПласт» является направление «Источники питания». Мы предлагаем Вам помощь Конструкторского отдела:

- Подбор оптимального решения, техническое обоснование при выборе компонента;
- Подбор аналогов;
- Консультации по применению компонента;
- Поставка образцов и прототипов;
- Техническая поддержка проекта;
- Защита от снятия компонента с производства.



#### Как с нами связаться

**Телефон:** 8 (812) 309 58 32 (многоканальный)

**Факс:** 8 (812) 320-02-42

**Электронная почта:** [org@eplast1.ru](mailto:org@eplast1.ru)

**Адрес:** 198099, г. Санкт-Петербург, ул. Калинина, дом 2, корпус 4, литера А.