



## GaAs PHEMT MMIC LOW NOISE AMPLIFIER, 350 - 550 MHz

### Typical Applications

The HMC356LP3 / HMC356LP3E is ideal for basestation receivers:

- GSM 450 & GSM 480
- CDMA 450
- Private Land Mobile Radio

### Features

- Noise Figure:  $\leq 1.0$  dB
- +38 dBm Output IP3
- Gain: 17 dB
- Very Stable Gain vs. Supply & Temperature
- Single Supply: +5V @ 104 mA
- 50 Ohm Matched Output

### Functional Diagram

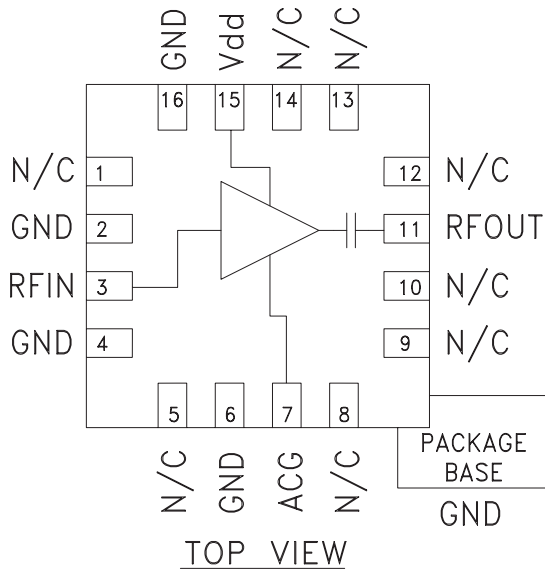

### General Description

The HMC356LP3 & HMC356LP3E are high dynamic range GaAs PHEMT MMIC Low Noise Amplifiers is ideal for GSM & CDMA cellular basestation and Mobile Radio front-end receivers operating between 350 and 550 MHz. This LNA has been optimized to provide 1.0 dB noise figure, 17 dB gain and +38 dBm output IP3 from a single supply of +5V @ 104 mA. Input and output return losses are 15 dB typical, with the LNA requiring only four external components to optimize the RF input match, RF ground and DC bias. For applications which require improved noise figure, please see the HMC616LP3(E).

### Electrical Specifications, $T_A = +25^\circ\text{C}$ , $V_S = +5\text{V}$

Parameter	Min.	Typ.	Max.	Units
Frequency Range	350 - 550			MHz
Gain	15	17		dB
Gain Variation Over Temperature		0.0032	0.010	dB / °C
Noise Figure		1.0	1.4	dB
Input Return Loss		17		dB
Output Return Loss		12		dB
Reverse Isolation		24		dB
Output Power for 1dB Compression (P1dB)	17	21		dBm
Saturated Output Power (Psat)		22.5		dBm
Output Third Order Intercept (IP3) (-20 dBm Input Power per tone, 1 MHz tone spacing)	34	38		dBm
Supply Current (I <sub>dd</sub> )		104		mA

Information furnished by Analog Devices is believed to be accurate and reliable. However, no responsibility is assumed by Analog Devices for its use, nor for any infringements of patents or other rights of third parties that may result from its use. Specifications subject to change without notice. No license is granted by implication or otherwise under any patent or patent rights of Analog Devices. Trademarks and registered trademarks are the property of their respective owners.

For price, delivery, and to place orders: Analog Devices, Inc., One Technology Way, P.O. Box 9106, Norwood, MA 02062-9106  
 Phone: 781-329-4700 • Order online at [www.analog.com](http://www.analog.com)  
 Application Support: Phone: 1-800-ANALOG-D



**GaAs PHEMT MMIC LOW NOISE AMPLIFIER, 350 - 550 MHz**

**Broadband Gain & Return Loss**

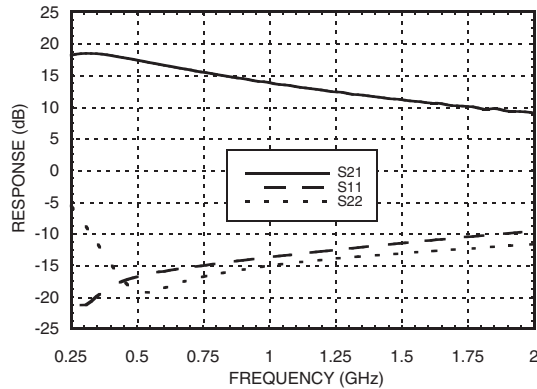

**Noise Figure vs. Temperature**

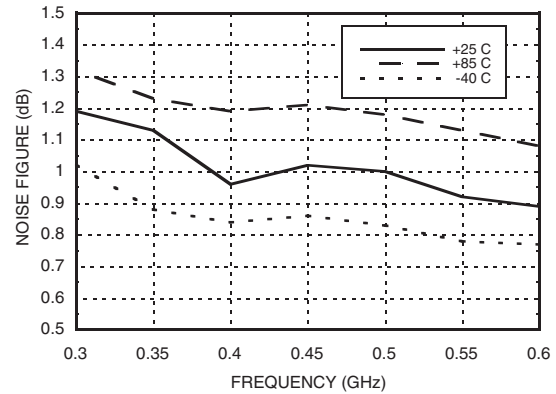

**Gain vs. Temperature**

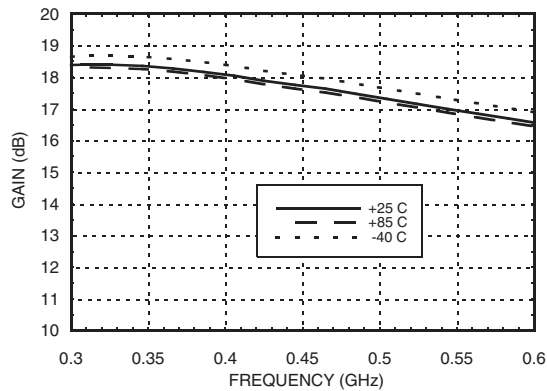

**Noise Figure vs. Vdd**

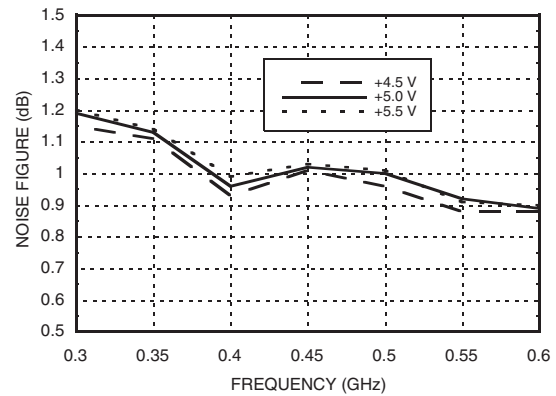

**Gain vs. Vdd**

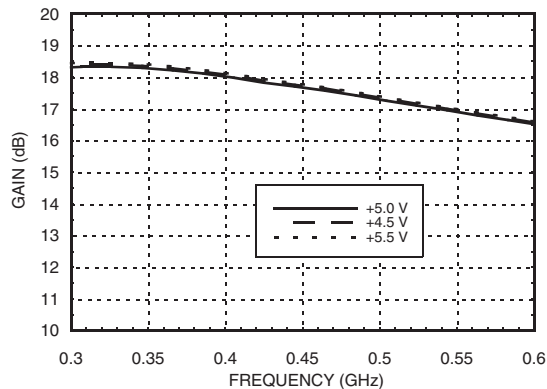

**Reverse Isolation**

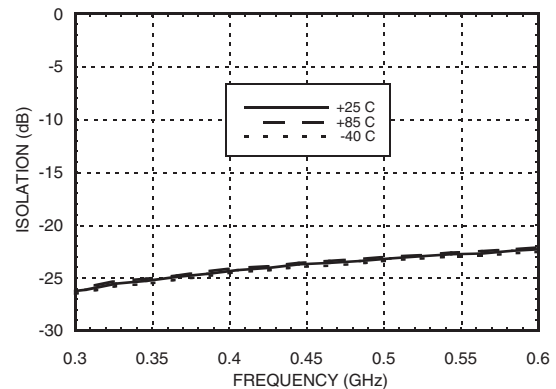

Information furnished by Analog Devices is believed to be accurate and reliable. However, no responsibility is assumed by Analog Devices for its use, nor for any infringements of patents or other rights of third parties that may result from its use. Specifications subject to change without notice. No license is granted by implication or otherwise under any patent or patent rights of Analog Devices. Trademarks and registered trademarks are the property of their respective owners.

For price, delivery, and to place orders: Analog Devices, Inc., One Technology Way, P.O. Box 9106, Norwood, MA 02062-9106 Phone: 781-329-4700 • Order online at [www.analog.com](http://www.analog.com) Application Support: Phone: 1-800-ANALOG-D

**GaAs PHEMT MMIC LOW NOISE  
AMPLIFIER, 350 - 550 MHz**



7

AMPLIFIERS - LOW NOISE - SMT

**Input Return Loss vs. Temperature**

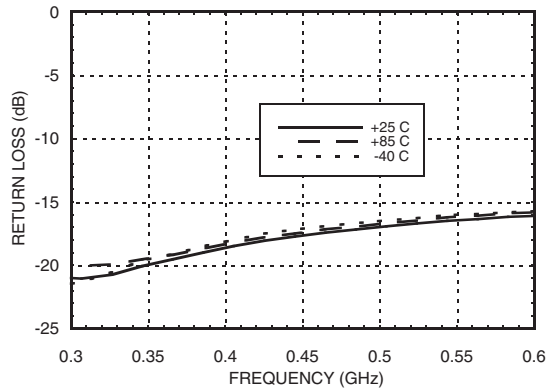

**Output Return Loss vs. Temperature**

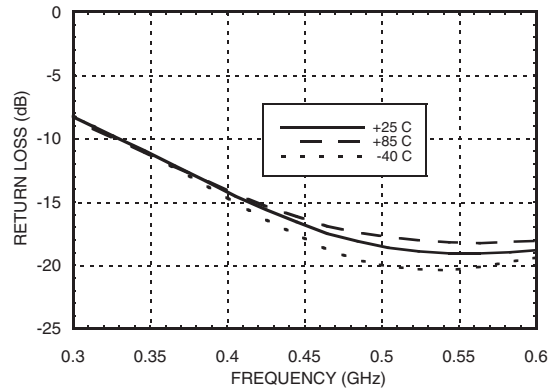

**Output IP3 vs. Temperature**

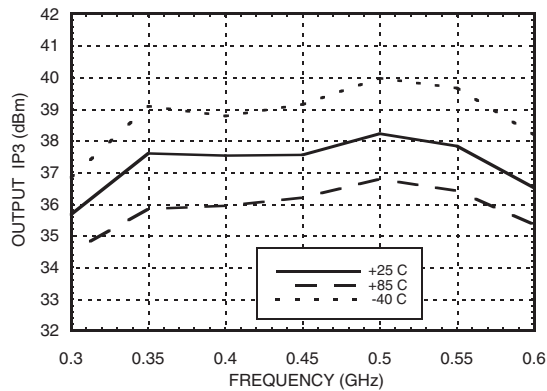

**P1dB & Psat vs. Temperature**

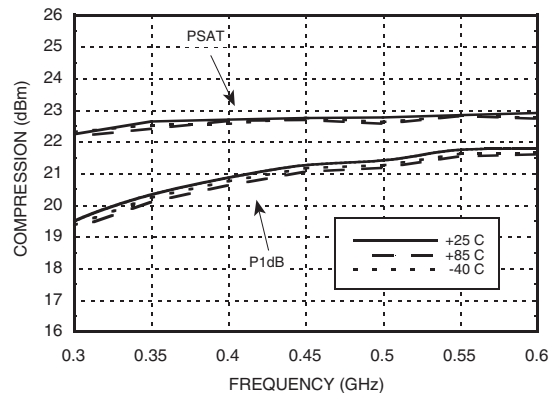

**Output IP3 vs. Vdd**

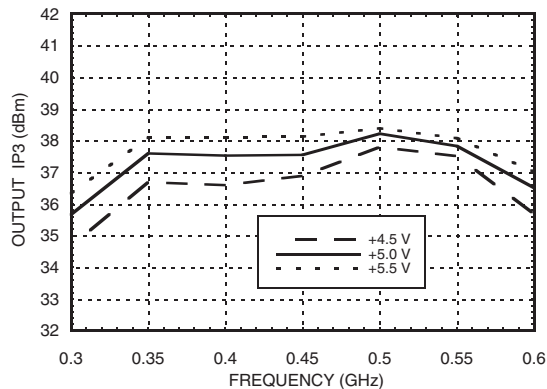

**P1dB vs. Vdd**

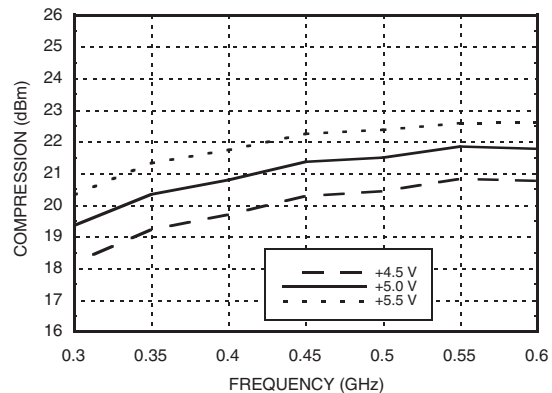

Information furnished by Analog Devices is believed to be accurate and reliable. However, no responsibility is assumed by Analog Devices for its use, nor for any infringements of patents or other rights of third parties that may result from its use. Specifications subject to change without notice. No license is granted by implication or otherwise under any patent or patent rights of Analog Devices. Trademarks and registered trademarks are the property of their respective owners.

For price, delivery, and to place orders: Analog Devices, Inc., One Technology Way, P.O. Box 9106, Norwood, MA 02062-9106 Phone: 781-329-4700 • Order online at [www.analog.com](http://www.analog.com) Application Support: Phone: 1-800-ANALOG-D

## GaAs PHEMT MMIC LOW NOISE AMPLIFIER, 350 - 550 MHz



### Absolute Maximum Ratings

Drain Bias Voltage (Vdd)	+8.0 Vdc
RF Input Power (RFIN)(Vdd = +5.0 Vdc)	+15 dBm
Channel Temperature	150 °C
Continuous P <sub>diss</sub> (T = 85 °C) (derate 14 mW/°C above 85 °C)	0.910 W
Thermal Resistance (channel to ground paddle)	71.4 °C/W
Storage Temperature	-65 to +150 °C
Operating Temperature	-40 to +85 °C

### Typical Supply Current vs. Vdd

Vdd (Vdc)	I <sub>dd</sub> (mA)
+4.5	103
+5.0	104
+5.5	105



ELECTROSTATIC SENSITIVE DEVICE  
OBSERVE HANDLING PRECAUTIONS

### Outline Drawing

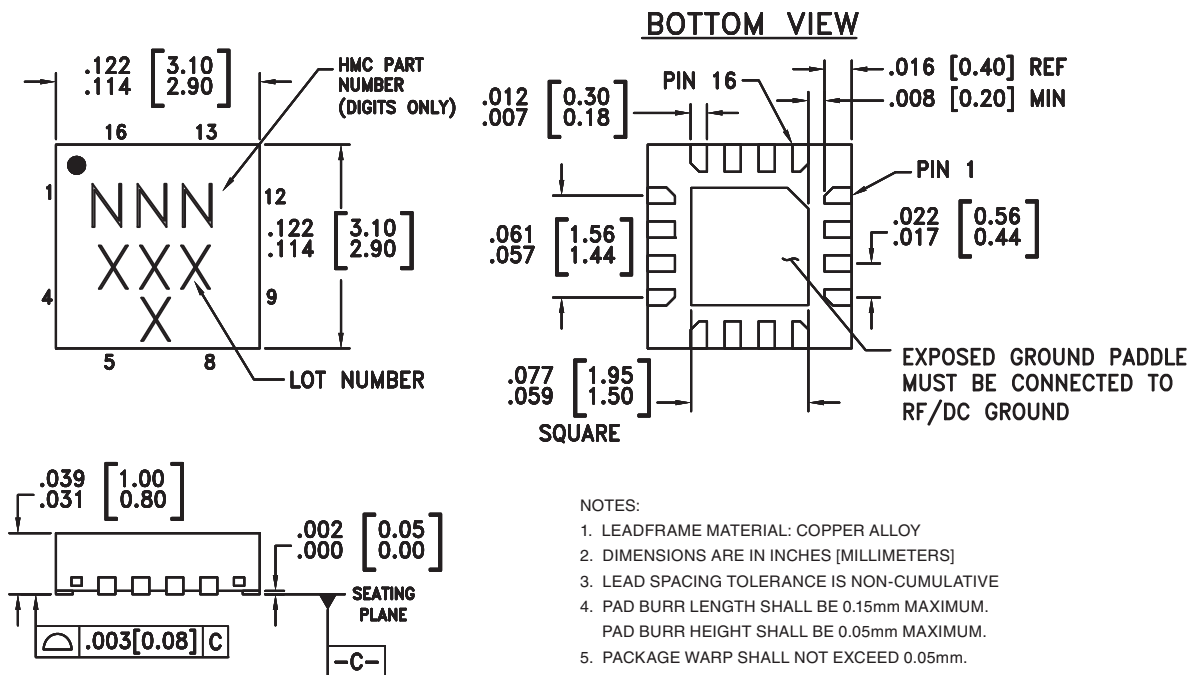

NOTES:

- LEADFRAME MATERIAL: COPPER ALLOY
- DIMENSIONS ARE IN INCHES [MILLIMETERS]
- LEAD SPACING TOLERANCE IS NON-CUMULATIVE
- PAD BURR LENGTH SHALL BE 0.15mm MAXIMUM.  
PAD BURR HEIGHT SHALL BE 0.05mm MAXIMUM.
- PACKAGE WARP SHALL NOT EXCEED 0.05mm.
- ALL GROUND LEADS AND GROUND PADDLE MUST BE SOLDERED TO PCB RF GROUND.
- REFER TO HITTITE APPLICATION NOTE FOR SUGGESTED LAND PATTERN.

### Package Information

Part Number	Package Body Material	Lead Finish	MSL Rating	Package Marking <sup>[3]</sup>
HMC356LP3	Low Stress Injection Molded Plastic	Sn/Pb Solder	MSL1 <sup>[1]</sup>	356 XXXX
HMC356LP3E	RoHS-compliant Low Stress Injection Molded Plastic	100% matte Sn	MSL1 <sup>[2]</sup>	356 XXXX

[1] Max peak reflow temperature of 235 °C

[2] Max peak reflow temperature of 260 °C

[3] 4-Digit lot number XXXX



### Pin Descriptions

Pin Number	Function	Description	Interface Schematic
1, 5, 8, 9, 10, 12, 13, 14	N/C	No connection necessary. These pins may be connected to RF/DC ground.	
2, 4, 6, 16	GND	These pins and package ground paddle must be connected to RF/DC ground.	
3	RFIN	This pin is matched to 50 Ohms with a 51 nH inductor to ground. See Application Circuit.	
7	ACG	AC Ground - An external capacitor of 0.01µF to ground is required for low frequency bypassing. See Application Circuit for further details.	
11	RFOUT	This pin is AC coupled and matched to 50 Ohms.	
15	Vdd	Power supply voltage. Choke inductor and bypass capacitor are required. See application circuit.	

### Application & Evaluation PCB Circuit

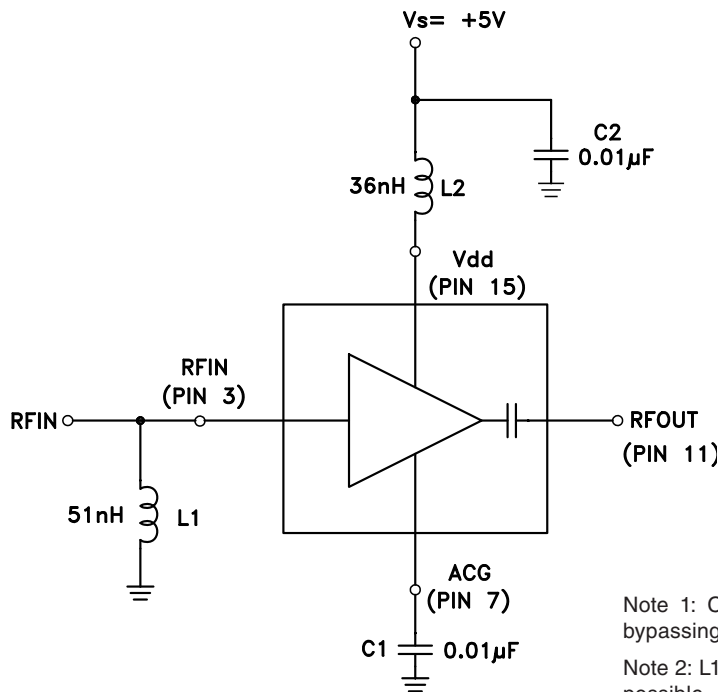

Note 1: Choose value of capacitor C1 for low frequency bypassing. A 0.01 µF ±10% capacitor is recommended.

Note 2: L1, L2 and C1 should be located as close to pins as possible.

**Evaluation PCB**

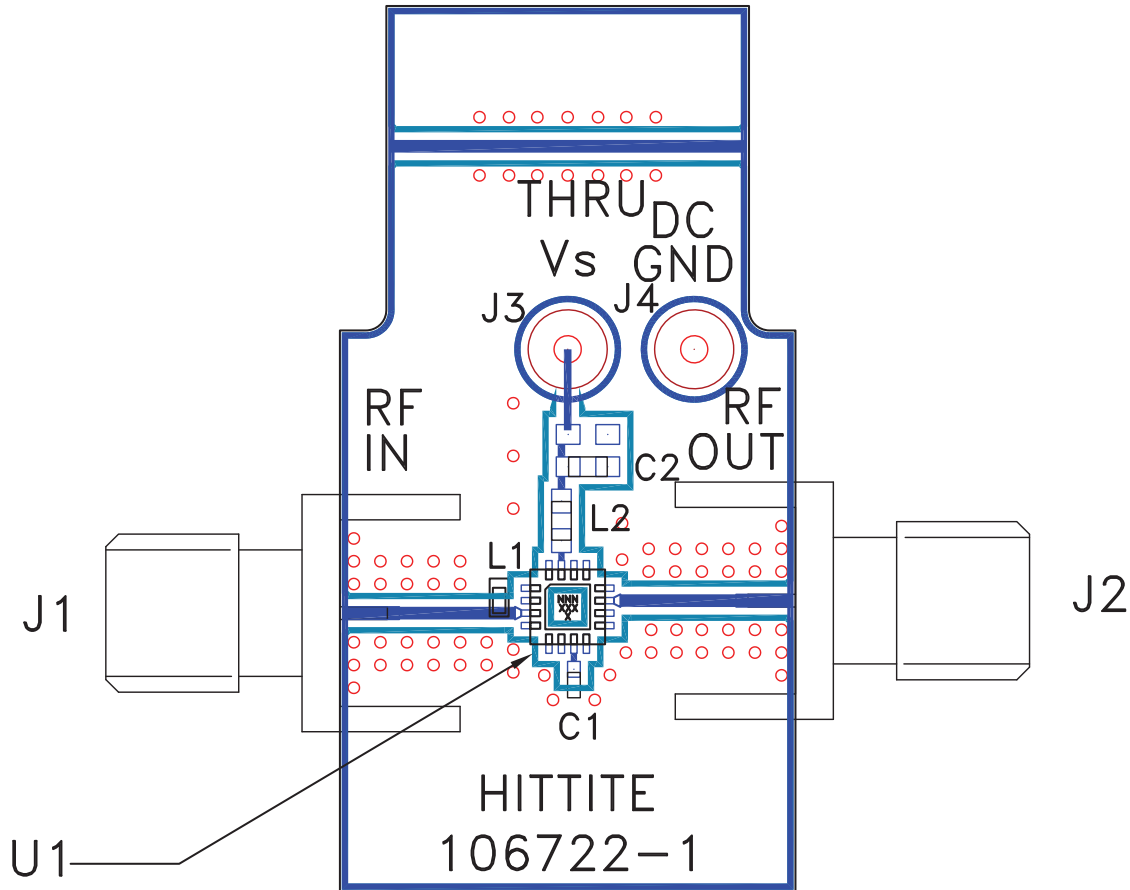

**List of Materials for Evaluation PCB 107795 [1]**

Item	Description
J1 - J2	PCB Mount SMA RF Connector
J3 - J4	DC Pin
C1	10,000 pF Capacitor, 0402 Pkg.
C2	10,000 pF Capacitor, 0603 Pkg.
L1	51 nH Inductor, 0402 Pkg.
L2	36 nH Inductor, 0603 Pkg.
U1	HMC356LP3 / HMC356LP3E Amplifier
PCB [2]	106722 Evaluation PCB

The circuit board used in the application should use RF circuit design techniques. Signal lines should have 50 Ohm impedance while the package ground leads and exposed paddle should be connected directly to the ground plane similar to that shown. A sufficient number of via holes should be used to connect the top and bottom ground planes. The evaluation circuit board shown is available from Hittite upon request.

[1] Reference this number when ordering complete evaluation PCB

[2] Circuit Board Material: Rogers 4350



Компания «ЭлектроПласт» предлагает заключение долгосрочных отношений при поставках импортных электронных компонентов на взаимовыгодных условиях!

Наши преимущества:

- Оперативные поставки широкого спектра электронных компонентов отечественного и импортного производства напрямую от производителей и с крупнейших мировых складов;
- Поставка более 17-ти миллионов наименований электронных компонентов;
- Поставка сложных, дефицитных, либо снятых с производства позиций;
- Оперативные сроки поставки под заказ (от 5 рабочих дней);
- Экспресс доставка в любую точку России;
- Техническая поддержка проекта, помощь в подборе аналогов, поставка прототипов;
- Система менеджмента качества сертифицирована по Международному стандарту ISO 9001;
- Лицензия ФСБ на осуществление работ с использованием сведений, составляющих государственную тайну;
- Поставка специализированных компонентов (Xilinx, Altera, Analog Devices, Intersil, Interpoint, Microsemi, Aeroflex, Peregrine, Syfer, Eurofarad, Texas Instrument, Miteq, Cobham, E2V, MA-COM, Hittite, Mini-Circuits, General Dynamics и др.);

Помимо этого, одним из направлений компании «ЭлектроПласт» является направление «Источники питания». Мы предлагаем Вам помощь Конструкторского отдела:

- Подбор оптимального решения, техническое обоснование при выборе компонента;
- Подбор аналогов;
- Консультации по применению компонента;
- Поставка образцов и прототипов;
- Техническая поддержка проекта;
- Защита от снятия компонента с производства.



#### Как с нами связаться

**Телефон:** 8 (812) 309 58 32 (многоканальный)

**Факс:** 8 (812) 320-02-42

**Электронная почта:** [org@eplast1.ru](mailto:org@eplast1.ru)

**Адрес:** 198099, г. Санкт-Петербург, ул. Калинина, дом 2, корпус 4, литера А.