

## 1.2A Buck/Boost Charge Pump LED Driver

### FEATURES

- Output Current up to 1.2A
- Up to 94% Efficiency in Torch Mode
- Adjustable FLASH Mode Current
- Minimum External Components: No Inductors
- Automatic Buck/Boost Mode Switchover
- Wide  $V_{IN}$  Range: 2.7V to 5.5V
- High Frequency Operation: 2.4 MHz
- 50mV Reference for low Loss Sensing
- $I_Q < 2\mu A$  in Shutdown
- PWM Dimming Control
- Automatic Soft Start Limits Inrush Current
- Overvoltage Protection on Output
- Overcurrent/temperature Protection
- Low Ripple and EMI
- Ultra-low Dropout Voltage in Buck Mode
- 2.6 Second Timeout in Flash Mode
- Space Saving RoHS Compliant, Lead Free Package: 10-pin 3mm x 3mm DFN

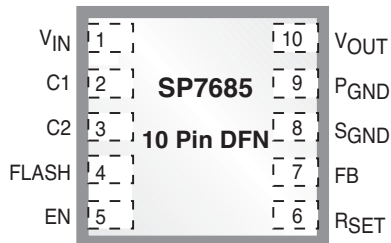

### APPLICATIONS

- White LED Torch/Flash for Cell Phones, DSCs, and Camcorders
- White LED Backlighting
- Generic Lighting/Flash/Strobe Applications
- General Purpose High Current Boost

### DESCRIPTION

The SP7685 is a current-regulated charge pump ideal for powering high brightness LEDs for camera flash applications. The charge pump can be set to regulate two current levels for FLASH and TORCH modes. The SP7685 automatically switches modes between step-up and step-down ensuring that LED current does not depend on the forward voltage. A low current sense reference voltage (50mV) allows the use of small 0603 current sensing resistors. The SP7685 is offered in 10-pin DFN package.

### TYPICAL APPLICATION CIRCUIT

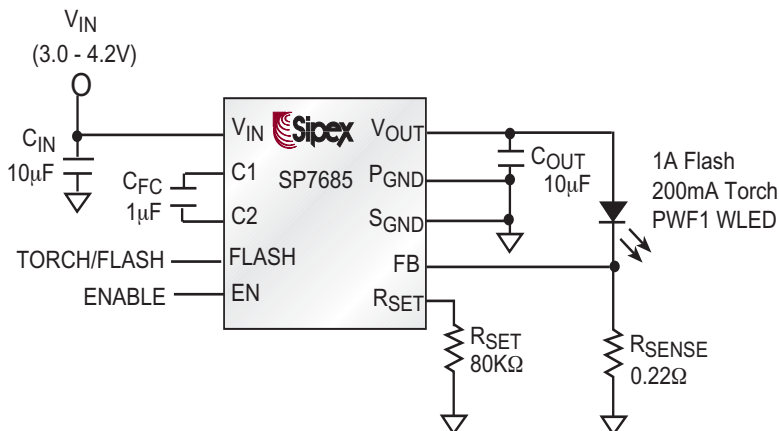

## ABSOLUTE MAXIMUM RATINGS

|   |  |
|---|--|
| $V_{IN}, V_{OUT}$ .....                 | -0.3V to 6V                            |
| Output Current Pulse (Flash) .....      | 2A                                     |
| Output Current Continuous (Torch) ..... | 0.4A                                   |
| Storage Temperature .....               | -65°C to +150°C                        |
| Operating Temperature .....             | -40°C to +85°C                         |
| $V_{EN}$ .....                          | 0.0V to 7V                             |
| 3x3 10 DFN .....                        | $\Theta_{JA} = 40.5^{\circ}\text{C/W}$ |
| ESD Rating .....                        | 2kV HBM                                |

These are stress ratings only and functional operation of the device at these ratings or any other above those indicated in the operation sections of the specifications below is not implied. Exposure to absolute maximum rating conditions for extended periods of time may affect reliability.

## ELECTRICAL CHARACTERISTICS

$T_A = -40^{\circ}\text{C}$  to  $+85^{\circ}\text{C}$ ,  $V_{IN} = 3.6\text{V}$ ,  $C_{IN} = 10\mu\text{F}$ ,  $C_{FC} = 1.0\mu\text{F}$ ,  $C_{OUT} = 10\mu\text{F}$ .  $V_{SHDN} = V_{IN}$ , typical values at  $25^{\circ}\text{C}$ . The ♦ denotes the specifications which apply over the full operating temperature range unless otherwise noted.

| PARAMETER                                   | MIN. | TYP. | MAX. | UNITS              |   | CONDITIONS   |
|---|------|------|------|--------------------|---|--|
| Operating Input Voltage                     | 2.7  |      | 5.5  | V                  | ♦ |  |
| Quiescent Current                           |      | 0.5  | 3    | mA                 | ♦ | $V_{IN} = 2.7 - 5.5\text{V}$ FLASH = GND, 1X Mode, $I_{LOAD} = 100\mu\text{A}$ |
|   |      | 2    |      |                    |   | FLASH = High, 2x mode  |
| Shutdown Current                            |      |      | 2    | $\mu\text{A}$      |   | $V_{IN} = 5.5\text{V}$ , $V_{EN} = 0.0\text{V}$                                |
| Oscillator Frequency                        |      | 2.4  |      | MHz                |   |  |
| Charge Pump Equivalent Resistance (x2 mode) |      | 4    |      | $\Omega$           |   | $V_{FB} = 0.0\text{V}$ , $V_{IN} = 3.6\text{V}$                                |
| Charge Pump Equivalent Resistance (x1 mode) |      | 0.4  | 0.7  | $\Omega$           |   | $V_{IN} = 3.6\text{V}$   |
| FB Reference Voltage                        | 45   | 50   | 55   | mV                 | ♦ | FLASH = GND  |
|   | 138  | 150  | 162  | mV                 | ♦ | FLASH = High, $R_{SET} = 53.6\text{k}\Omega$                                   |
| FB Reference Voltage Range                  | 100  |      | 400  | mV                 | ♦ | FLASH = High. Guaranteed by design.  |
| FB Pin Current                              |      |      | 0.5  | $\mu\text{A}$      |   | $V_{FB} = 0.3\text{V}$   |
| EN, FLASH Logic Low                         |      |      | 0.4  | V                  | ♦ |  |
| EN, FLASH Logic High                        | 1.3  |      |      | V                  | ♦ |  |
| EN, FLASH Pin Current                       |      |      | 0.5  | $\mu\text{A}$      | ♦ |  |
| $V_{OUT}$ Turn-on Time                      |      | 170  | 500  | $\mu\text{s}$      | ♦ | $V_{IN} = 3.6\text{V}$ , FB within 90% of regulation                           |
| Thermal Shutdown Temperature                |      | 145  |      | $^{\circ}\text{C}$ |   |  |
| Maximum Flash ON time                       | 1.6  | 2.6  | 3.6  | s                  | ♦ | FLASH = High   |

| PIN NUMBER | PIN NAME         | DESCRIPTION   |
|------------|------------------|---|
| 1          | V <sub>IN</sub>  | Input Voltage for the charge pump. Decouple with 4.7 $\mu$ F ceramic capacitor close to the pins of the IC.   |
| 2          | C1               | Positive input for the external flying capacitor. Connect a ceramic 1 $\mu$ F capacitor close to the pins of the IC.  |
| 3          | C2               | Negative input for the external flying capacitor. Connect a ceramic 1 $\mu$ F capacitor close to the pins of the IC.  |
| 4          | FLASH            | Logic input to toggle operation between FLASH and TORCH mode. In TORCH mode FB is regulated to the internal 50mV reference. In FLASH mode FB reference voltage can be adjusted by changing the resistor from R <sub>SET</sub> pin to ground. Choose the external current sense resistor (R <sub>SENSE</sub> ) based on desired current in TORCH mode. This pin does not have an internal pull-up/pull-down; do not leave this pin floating. |
| 5          | EN               | Shutdown control input. Connect to V <sub>IN</sub> for normal operation, connect to ground for shutdown. This pin does not have an internal pull-up/pull-down; do not leave this pin floating.  |
| 6          | R <sub>SET</sub> | Connect a resistor from this pin to ground. When in FLASH mode (FLASH = High) this resistor sets the current regulation point according to the following: V <sub>FB</sub> = R <sub>SET</sub> *14 $\mu$ A/5 (Flash Mode)   |
| 7          | FB               | Feedback input for the current control loop. Connect directly to the current sense resistor.  |
| 8          | S <sub>GND</sub> | Internal ground pin. Control circuitry returns current to this pin.   |
| 9          | P <sub>GND</sub> | Power ground pin. Flying capacitor current returns through this pin.  |
| 10         | V <sub>OUT</sub> | Charge Pump Output Voltage. Decouple with an external capacitor. At least 1 $\mu$ F is recommended. Higher capacitor values reduce output ripple  |

## FUNCTIONAL DIAGRAM

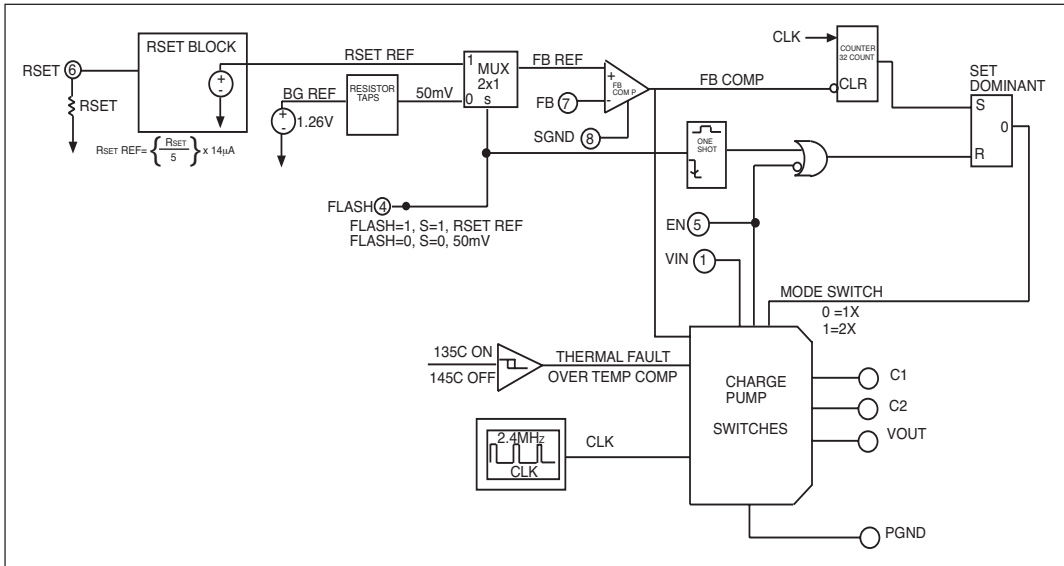

## THEORY OF OPERATION

The SP7685 is a charge pump regulator designed for converting a Li-Ion battery voltage of 2.7V to 4.2V to drive a white LED used in digital still camera Flash and Torch applications. The SP7685 has two modes of operation which are pin-selectable for either Flash or Torch. Flash mode is usually used with a pulse of about 200 to 300 milliseconds to generate a high intensity Flash. Torch can be used continuously at a lower output current than Flash and is often used for several seconds in a digital still camera “movie” mode.

The SP7685 also has two modes of operation to control the output current: the 1X mode and 2X mode. Operation begins after the enable pin EN receives a logic high, the bandgap reference wakes up after 200 $\mu$ s, and then SP7685 goes through a soft-start mode designed to reduce inrush current. The SP7685 starts in the 1X mode, which

acts like a linear regulator to control the output current by continuously monitoring the feedback pin FB. In 1X mode, if the SP7685 auto detects a dropout condition, which is when the FB pin is below the regulation point for more than 32 cycles of the internal clock, the SP7685 automatically switches to the 2X mode. The SP7685 remains in the 2X mode until one of four things happens: 1) the enable pin EN has been toggled, 2) the Flash pin has changed from high to low, 3)  $V_{IN}$  is cycled or, 4) a thermal fault occurs.

The 2X mode is the charge pump mode where the output can be pumped as high as two times the input voltage, provided the output does not exceed the maximum voltage for the SP7685, which is internally limited to about 5.5V. In the 2X mode, as in the 1X mode, the output current is regulated by the voltage at the FB pin.

In the Torch mode, (Flash = GND) the Flash pin is set to logic low and the SP7685 FB pin regulates to 50mV output:

$$V_{FB} = 50\text{mV (Torch Mode)}$$

When in Flash mode, (Flash =  $V_{IN}$ ), the FB regulation voltage is set by the resistor  $R_{SET}$  connected between the  $R_{SET}$  pin and  $S_{GND}$  and the equation:

$$V_{FB} = R_{SET} * 14\mu\text{A} / 5 \text{ (Flash Mode)}$$

Where  $14\mu\text{A}$  is an internal regulated current and 5 is an internal factor used to scale the  $V_{SET}$  voltage to the  $V_{FB}$  voltage. Typical values of  $R_{SET}$  are  $140\text{K}\Omega$  to  $35\text{K}\Omega$  for a range of  $V_{FB} = 400\text{mV}$  to  $100\text{mV}$  in Flash mode.

The output current is then set in either Flash or Torch mode by the equation:

$$I_{OUT} = V_{FB} / R_{SENSE}$$

### FLASH TIMEOUT PROTECTION

Due to the high currents typically available in Flash mode, it is necessary to protect the white LED from damage if left on too long. The SP7685 has a timeout in Flash mode of approximately 2.6 seconds after which it will shut down operation. Operation will not begin again in Flash mode until the Enable pin or Flash pin have been set Low and then High again.

### OVERTEMPERATURE PROTECTION

When the temperature of the SP7685 rises above  $145^{\circ}\text{C}$ , the overtemperature protec-

tion circuitry turns off the output switches to prevent damage to the device. If the temperature drops back down below  $135^{\circ}\text{C}$ , the part automatically recovers and executes a soft start cycle.

### OVERVOLTAGE PROTECTION

The SP7685 has over voltage protection. If the output voltage rises above the  $5.5\text{V}$  threshold, the over voltage protection shuts off all of the output switches to prevent the output voltage from rising further. When the output decreases below  $5.5\text{V}$ , the device resumes normal operation.

### OVERCURRENT PROTECTION

The over current protection circuitry monitors the average current out of the  $V_{OUT}$  pin. If the average output current exceeds approximately 1.6 Amps, then the overcurrent protection circuitry shuts off the output switches to protect the chip.

### BRIGHTNESS CONTROL USING PWM

Dimming control can be achieved by applying a PWM control signal to the EN pin. The brightness of the white LEDs is controlled by increasing and decreasing the duty cycle of the PWM signal. While the operating frequency range of the PWM control is from  $60\text{Hz}$  to  $700\text{Hz}$ , the recommended maximum brightness frequency range of the PWM signal is from  $60\text{Hz}$  to  $200\text{Hz}$ . A repetition rate of at least  $60\text{Hz}$  is required to prevent flicker.

$V_{IN}$ =3.6V, Typical Application Circuit,  $T_A$  = 25°C unless otherwise noted.

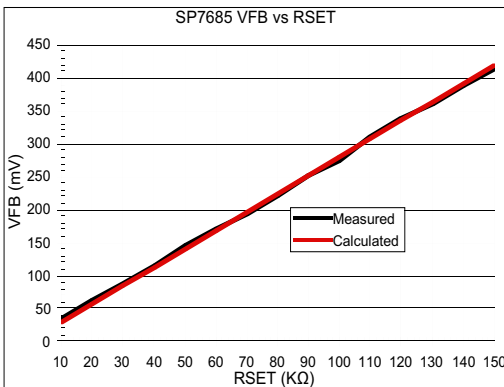
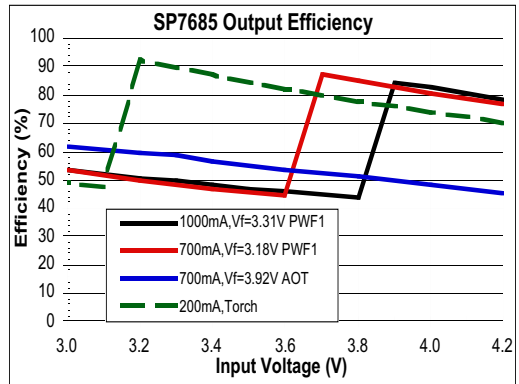
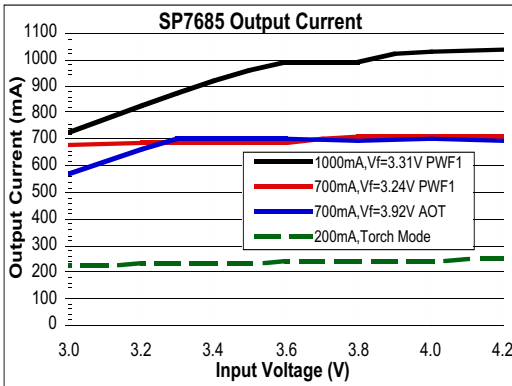
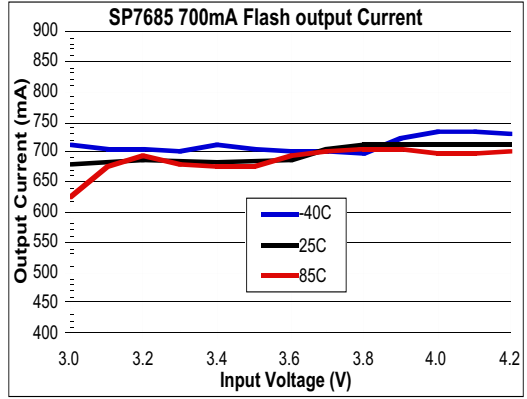
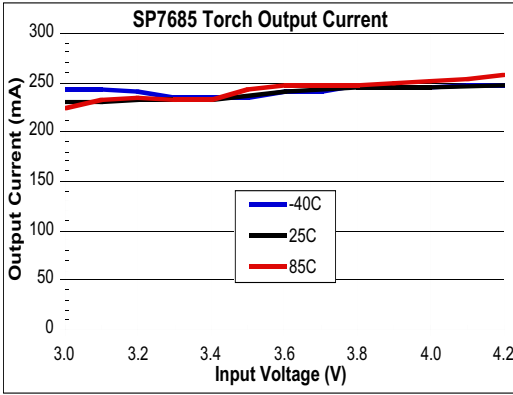

# APPLICATION INFORMATION

$V_{IN}=3.6V$ , Typical Application Circuit,  $T_A = 25^{\circ}C$  unless otherwise noted.

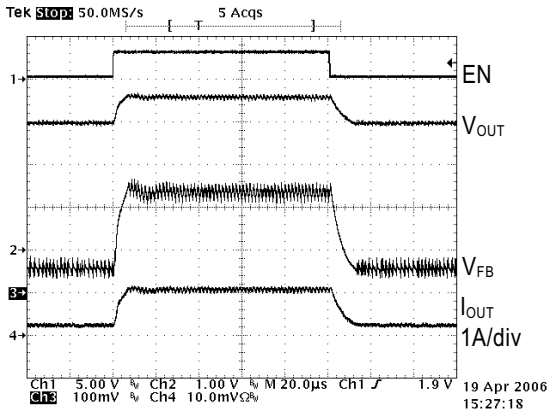

Torch in 1X to Flash in 1X Mode,  $V_{IN}=4.2V$

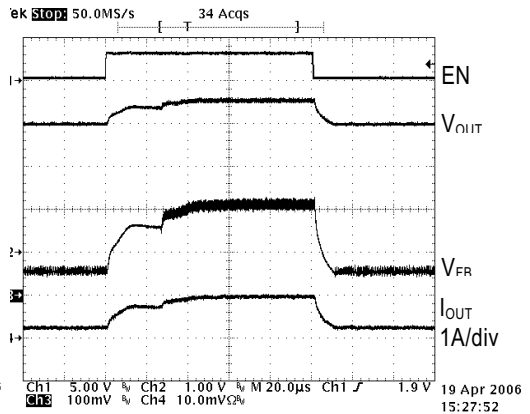

Torch in 1X to Flash in 2X Mode,  $V_{IN}=3.6V$

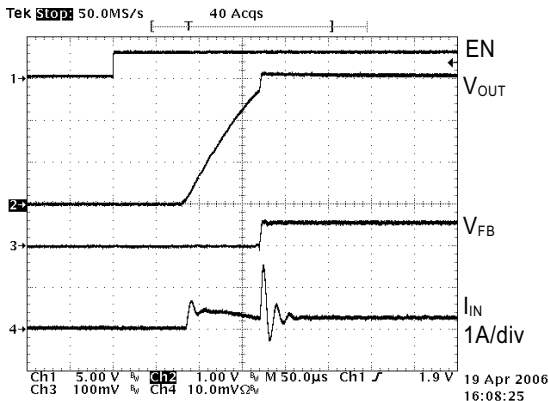

Start Up 200mA Torch  
 $V_{IN}=3.6V$ ,  $V_{OUT}=3.1V$

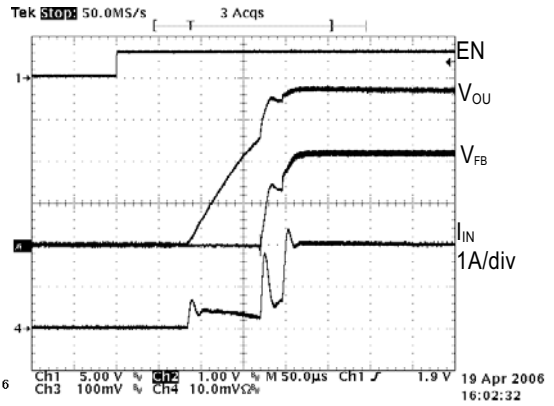

Start Up 1000mA Flash  
 $V_{IN}=3.6V$ ,  $V_{OUT}=3.8V$

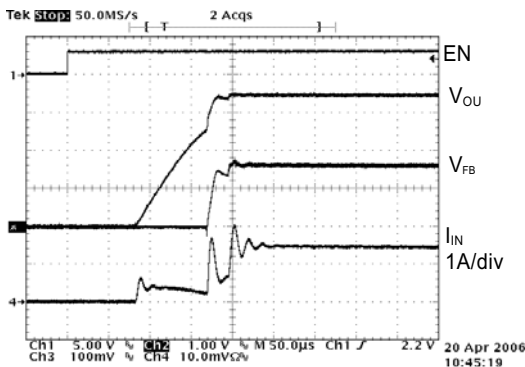

Start Up 700mA Flash  
 $V_{IN}=3.6V$ ,  $V_{OUT}=3.6V$

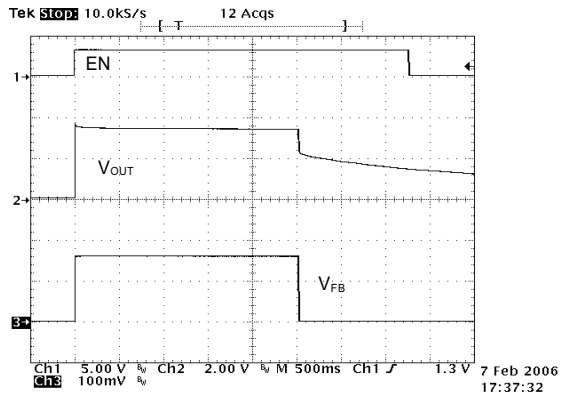

Flash Mode TimeOut Circuit at 2.6sec.  
 $V_{IN}=4.2V$ ,  $I_{OUT}=1A$

# APPLICATION INFORMATION

$V_{IN}=3.6V$ , Typical Application Circuit,  $T_A=25^{\circ}C$  unless otherwise noted.

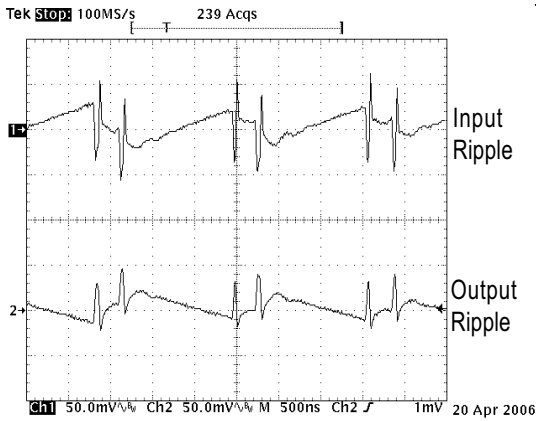

Ripple 1X Torch 200mA,  $V_{IN}=4.2V$

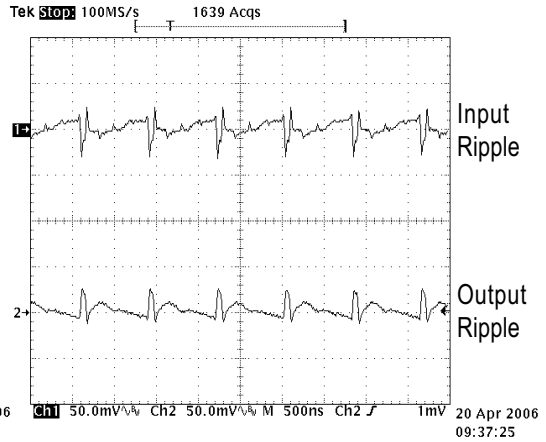

Ripple 2X Torch 200mA,  $V_{IN}=3.0V$

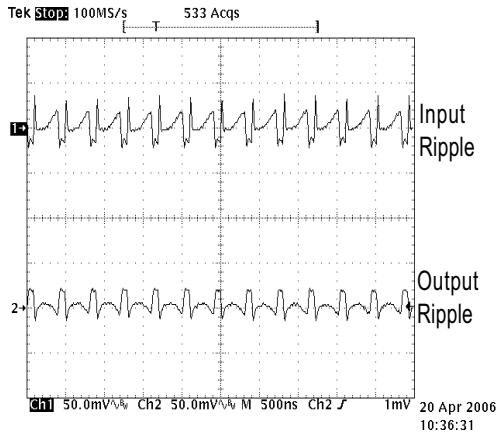

Ripple 1X Flash 700mA,  $V_{IN}=4.2V$

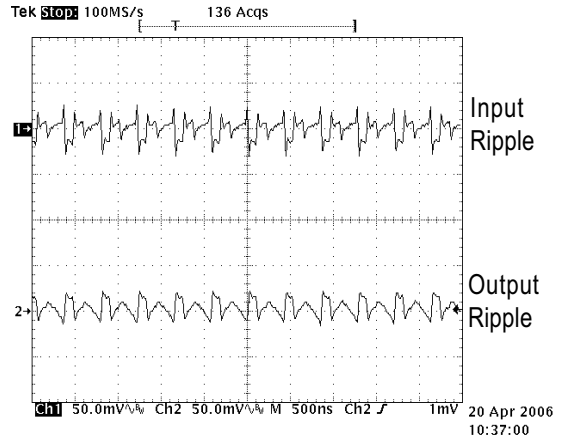

Ripple 2X Flash 700mA,  $V_{IN}=3.6V$

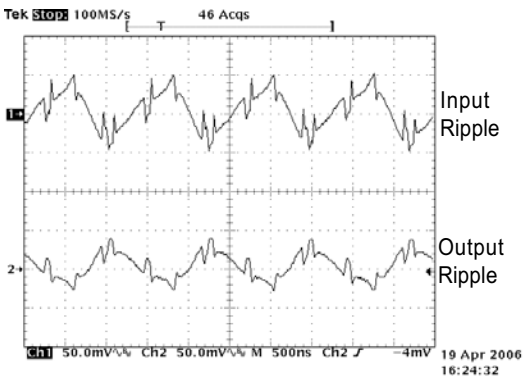

Ripple 1X Flash 1000mA,  $V_{IN}=4.2V$

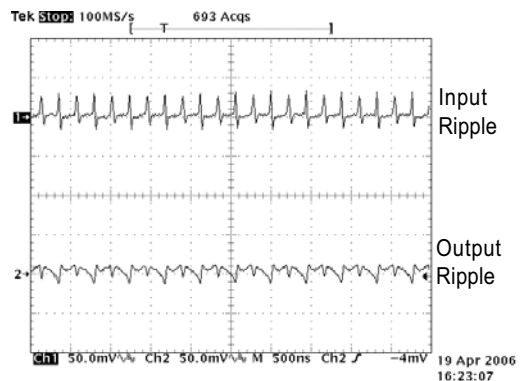

Ripple 2X Flash 1000mA,  $V_{IN}=3.6V$



The SP7685 charge pump circuit requires three capacitors: 10 $\mu$ F input, 10 $\mu$ F output and 1 $\mu$ F fly capacitor are typically recommended. For the input capacitor, a value of 10 $\mu$ F will help reduce input voltage ripple for applications sensitive to ripple on the battery voltage. All the capacitors should be surface mount ceramic for low lead inductance necessary at the 2.4MHz switching frequency of the SP7685 and to obtain low ESR, which improves bypassing on the input and output and improves output voltage drive by reducing output resistance. Ceramic capacitors with X5R or X7R temperature grade are recommended for most applications. A selection of recommended capacitors is included in Table 1 below.

| Manufacturer's Website | Part Number        | Capacitance/<br>Voltage | Capacitor Size/<br>Type/Thickness | ESR<br>@100kHz |
|------------------------|--------------------|-------------------------|-----------------------------------|----------------|
| TDK: www.tdk.com       | C1005X5R0J105M     | 1uF/6.3V                | 0402/X5R/0.5mm                    | 0.03           |
| TDK: www.tdk.com       | C1608X5R0J475K     | 4.7uF/6.3V              | 0603/X5R/0.9mm                    | 0.02           |
| TDK: www.tdk.com       | C2012X5R0J106M     | 10uF/6.3V               | 0805/X5R/1.35mm                   | 0.02           |
| Murata: www.murata.com | GRM155R60J105KE19B | 1uF/6.3V                | 0402/X5R/0.55mm                   | 0.03           |
| Murata: www.murata.com | GRM188R60J475KE19  | 4.7uF/6.3V              | 0603/X5R/0.9mm                    | 0.02           |
| Murata: www.murata.com | GRM21BR60J106KE19L | 10uF/6.3V               | 0805/X5R/1.35mm                   | 0.02           |

Table 1: Recommended Capacitors

The input and output capacitors should be located as close to the V<sub>IN</sub> and V<sub>OUT</sub> pins as possible to obtain best bypassing, and the returns should be connected directly to the P<sub>GND</sub> pin or to the thermal pad ground located under the SP7685. The fly capacitor should be located as close to the C1 and C2 pins as possible. See typical circuit layout at the end of this section for details on the recommended layout.

To obtain low output ripple, a value of 10 $\mu$ F is recommended for C<sub>OUT</sub>. For output currents of 500mA to 1.2A, the recommended C<sub>FC</sub> fly capacitor value of 1 $\mu$ F should be used. Output currents in Flash of 100mA to 400mA can use a 0.47 $\mu$ F C<sub>FC</sub> but a minimum 4.7 $\mu$ F C<sub>OUT</sub> is still needed.

**RESISTOR SELECTION**

The sense resistor R<sub>SENSE</sub> is determined by the value needed in the Torch mode for the desired output current by the equation:

$$R_{SENSE} = V_{FB} / I_{OUT} \text{ where } V_{FB} = 50mV \text{ (Torch Mode)}$$

Once the R<sub>SENSE</sub> resistor has been selected for Torch mode, the V<sub>FB</sub> voltage can be selected for Flash mode using the following equation:

$$V_{FB} = I_{OUT} * R_{SENSE} \text{ (Flash Mode) where } I_{OUT} \text{ is for Flash Mode.}$$

Next, the R<sub>SET</sub> resistor can be selected for Flash mode using the following equation:

$$R_{SET} = \left( \frac{V_{FB}}{14\mu A} \right) * 5 \Omega \text{ (Flash Mode)}$$

For an example of 200mA Torch mode and 700mA Flash mode, the values R<sub>SENSE</sub> = 0.22 $\Omega$ , V<sub>FB</sub> = 155mV (Flash Mode), and R<sub>SET</sub> = 56K $\Omega$  are calculated. The power obtained in the Flash mode would be:

$$P_{FLASH} = V_{FB} * I_{OUT} = 155mV * 700mA = 109mW.$$

The typical 0603 surface mount resistor is rated 1/10 Watt continuous power and 1/5

Watt pulsed power, more than enough for this application. For other applications, the  $P_{FLASH}$  power can be calculated and resistor size selected. The  $R_{SENSE}$  resistor is recom-

mended to be size 0603 for most applications. The range of typical resistor values and sizes are shown here in Table 2.

| Part Reference | Value         | Tolerance | Size | Manufacturers       |
|----------------|---------------|-----------|------|---------------------|
| RSET           | 33k $\Omega$  | 5%        | 0402 | any                 |
| RSET           | 39k $\Omega$  | 5%        | 0402 | any                 |
| RSET           | 43k $\Omega$  | 5%        | 0402 | any                 |
| RSET           | 47k $\Omega$  | 5%        | 0402 | any                 |
| RSET           | 56k $\Omega$  | 5%        | 0402 | any                 |
| RSET           | 62k $\Omega$  | 5%        | 0402 | any                 |
| RSET           | 68k $\Omega$  | 5%        | 0402 | any                 |
| RSET           | 82k $\Omega$  | 5%        | 0402 | any                 |
| RSET           | 100k $\Omega$ | 5%        | 0402 | any                 |
| RSET           | 110k $\Omega$ | 5%        | 0402 | any                 |
| RSET           | 120k $\Omega$ | 5%        | 0402 | any                 |
| RSET           | 150k $\Omega$ | 5%        | 0402 | any                 |
| RSENSE         | 0.22 $\Omega$ | 5%        | 0603 | Panasonic or Vishay |
| RSENSE         | 0.27 $\Omega$ | 5%        | 0603 | Panasonic or Vishay |
| RSENSE         | 0.33 $\Omega$ | 5%        | 0603 | Panasonic or Vishay |
| RSENSE         | 0.39 $\Omega$ | 5%        | 0603 | Panasonic or Vishay |
| RSENSE         | 0.47 $\Omega$ | 5%        | 0603 | Panasonic or Vishay |
| RSENSE         | 0.56 $\Omega$ | 105%      | 0604 | Panasonic or Vishay |
| RSENSE         | 0.68 $\Omega$ | 205%      | 0605 | Panasonic or Vishay |

Table 2: Resistor values and sizes

EVALUATION BOARD CIRCUIT LAYOUT

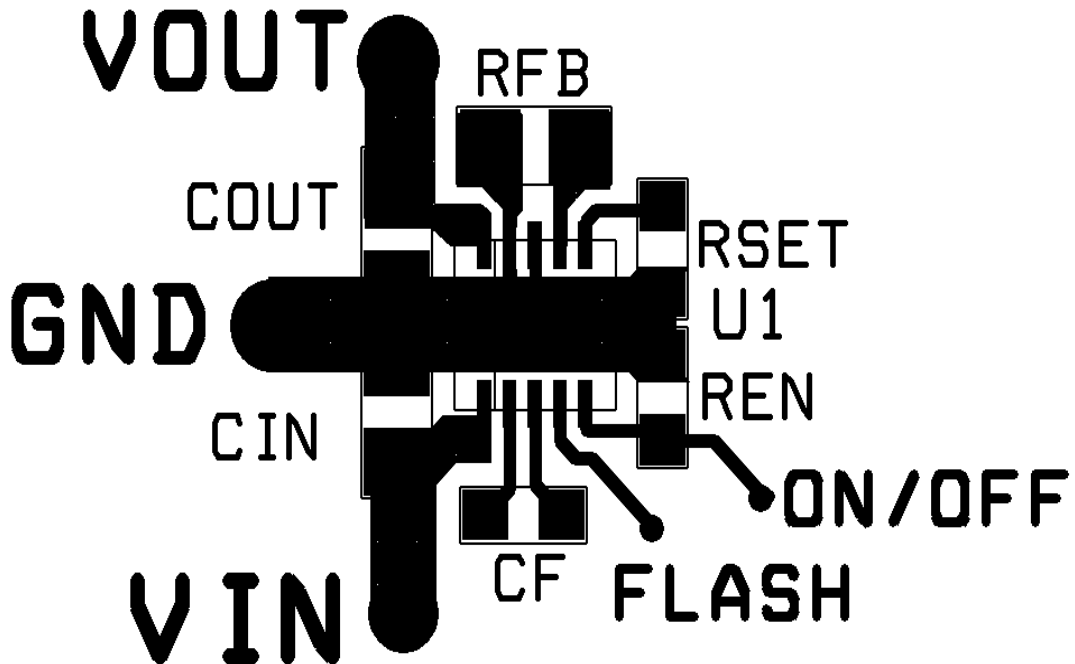

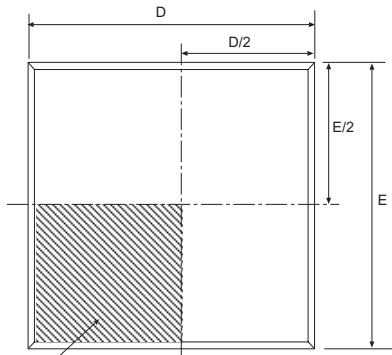

Pin1 Designator  
to be within this  
INDEX AREA  
(D/2 x E/2)

TOP VIEW

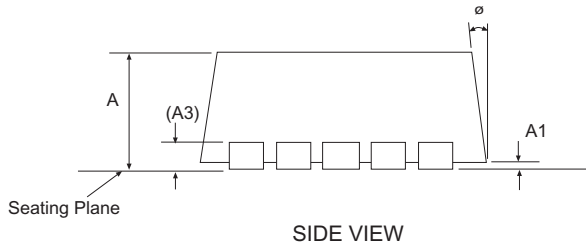

SIDE VIEW

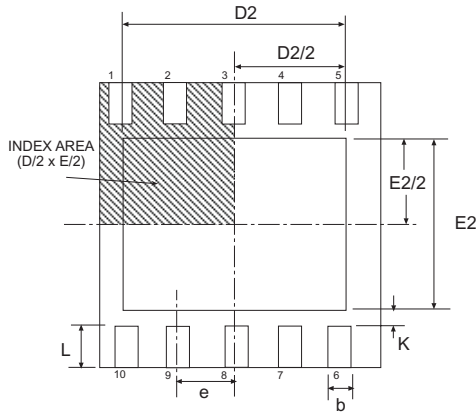

BOTTOM VIEW

| 3x3 10 Pin DFN              |   | JEDEC MO-229 |      | VARIATION VEED-5  |       |       |
|-----------------------------|---|--------------|------|---|-------|-------|
| SYMBOL                      | Dimensions in Millimeters:<br>Controlling Dimension |              |      | Dimensions in Inches<br>Conversion Factor:<br>1 Inch = 25.40 mm |       |       |
|                             | MIN   | NOM          | MAX  | MIN   | NOM   | MAX   |
| A                           | 0.80  | 0.90         | 1.00 | 0.032   | 0.036 | 0.039 |
| A1                          | 0.00  | 0.02         | 0.05 | 0.000   | 0.001 | 0.002 |
| A3                          | 0.20 REF  |              |      | 0.008 REF   |       |       |
| K                           | 0.20  | -            | -    | 0.008   | -     | -     |
| ø                           | 0°  | -            | 14°  | 0°  | -     | 14°   |
| b                           | 0.18  | 0.25         | 0.30 | 0.008   | 0.010 | 0.012 |
| D                           | 3.00 BSC  |              |      | 0.119 BSC   |       |       |
| D2                          | 2.20  | -            | 2.70 | 0.087   | -     | 0.106 |
| E                           | 3.00 BSC  |              |      | 0.119 BSC   |       |       |
| E2                          | 1.40  | -            | 1.75 | 0.056   | -     | 0.069 |
| e                           | 0.50 BSC  |              |      | 0.020 BSC   |       |       |
| L                           | 0.30  | 0.40         | 0.50 | 0.012   | 0.016 | 0.020 |
| SIPEX Pkg Signoff Date/Rev: |   |              |      | JL Aug09-05 / RevA  |       |       |

---

**ORDERING INFORMATION**

| <b>Part Number</b>  | <b>Operating Temperature Range</b> | <b>Package Type</b>    |
|---------------------|------------------------------------|------------------------|
| SP7685ER-L .....    | -40°C to +85°C .....               | (Lead Free) 10 Pin DFN |
| SP7685ER-L/TR ..... | -40°C to +85°C .....               | (Lead Free) 10 Pin DFN |

/TR = Tape and Reel

Pack quantity is 3,000 for DFN.

**Sipex Corporation**

**Headquarters and  
Sales Office**  
233 South Hillview Drive  
Milpitas, CA 95035  
TEL: (408) 934-7500  
FAX: (408) 935-7600

Sipex Corporation reserves the right to make changes to any products described herein. Sipex does not assume any liability arising out of the application or use of any product or circuit described herein; neither does it convey any license under its patent rights nor the rights of others.



Компания «ЭлектроПласт» предлагает заключение долгосрочных отношений при поставках импортных электронных компонентов на взаимовыгодных условиях!

Наши преимущества:

- Оперативные поставки широкого спектра электронных компонентов отечественного и импортного производства напрямую от производителей и с крупнейших мировых складов;
- Поставка более 17-ти миллионов наименований электронных компонентов;
- Поставка сложных, дефицитных, либо снятых с производства позиций;
- Оперативные сроки поставки под заказ (от 5 рабочих дней);
- Экспресс доставка в любую точку России;
- Техническая поддержка проекта, помощь в подборе аналогов, поставка прототипов;
- Система менеджмента качества сертифицирована по Международному стандарту ISO 9001;
- Лицензия ФСБ на осуществление работ с использованием сведений, составляющих государственную тайну;
- Поставка специализированных компонентов (Xilinx, Altera, Analog Devices, Intersil, Interpoint, Microsemi, Aeroflex, Peregrine, Syfer, Eurofarad, Texas Instrument, Miteq, Cobham, E2V, MA-COM, Hittite, Mini-Circuits, General Dynamics и др.);

Помимо этого, одним из направлений компании «ЭлектроПласт» является направление «Источники питания». Мы предлагаем Вам помощь Конструкторского отдела:

- Подбор оптимального решения, техническое обоснование при выборе компонента;
- Подбор аналогов;
- Консультации по применению компонента;
- Поставка образцов и прототипов;
- Техническая поддержка проекта;
- Защита от снятия компонента с производства.



#### Как с нами связаться

**Телефон:** 8 (812) 309 58 32 (многоканальный)

**Факс:** 8 (812) 320-02-42

**Электронная почта:** [org@eplast1.ru](mailto:org@eplast1.ru)

**Адрес:** 198099, г. Санкт-Петербург, ул. Калинина, дом 2, корпус 4, литера А.