

## Product Summary

| $V_{(BR)DSS}$ | $R_{DS(ON) \max}$            | $I_D \max$<br>$T_C = +25^\circ\text{C}$ |
|---------------|------------------------------|---|
| 100V          | 28mΩ @ $V_{GS} = 10\text{V}$ | 55A                                     |

## Description

This new generation MOSFET features low on-resistance and fast switching, making it ideal for high-efficiency power management applications.

## Applications

- Engine Management Systems
- Body Control Electronics
- DC-DC Converters

## Features

- Rated to +175°C – Ideal for High Ambient Temperature Environments
- 100% Unclamped Inductive Switching – Ensures More Reliable and Robust End Application
- Low  $R_{DS(ON)}$  – Minimises Power Losses
- Low  $Q_g$  – Minimises Switching Losses
- **Lead-Free Finish; RoHS Compliant (Notes 1 & 2)**
- **Halogen and Antimony Free. "Green" Device (Note 3)**
- **Qualified to AEC-Q101 Standards for High Reliability**
- **An Automotive-Compliant Part is Available Under Separate Datasheet ([DMNH10H028SK3Q](#))**

## Mechanical Data

- Case: TO252
- Case Material: Molded Plastic, "Green" Molding Compound. UL Flammability Classification Rating 94V-0
- Moisture Sensitivity: Level 1 per J-STD-020
- Terminal Connections: See Diagram
- Terminals: Finish – Matte Tin Annealed over Copper Leadframe Solderable per MIL-STD-202, Method 208
- Weight: 0.33 grams (Approximate)



Top View

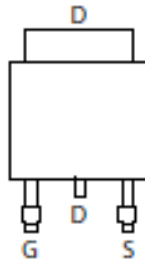

Pin Out Top View

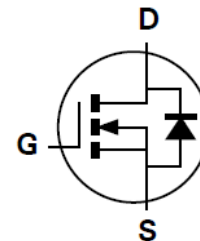

Equivalent Circuit

## Ordering Information (Note 4)

| Part Number      | Case  | Packaging         |
|------------------|-------|-------------------|
| DMNH10H028SK3-13 | TO252 | 2,500/Tape & Reel |

- Notes:
1. EU Directive 2002/95/EC (RoHS) & 2011/65/EU (RoHS 2) compliant. All applicable RoHS exemptions applied.
  2. See [http://www.diodes.com/quality/lead\\_free.html](http://www.diodes.com/quality/lead_free.html) for more information about Diodes Incorporated's definitions of Halogen- and Antimony-free, "Green" and Lead-free.
  3. Halogen- and Antimony-free "Green" products are defined as those which contain <900ppm bromine, <900ppm chlorine (<1500ppm total Br + Cl) and <1000ppm antimony compounds.
  4. For packaging details, go to our website at <http://www.diodes.com/products/packages.html>.

## Marking Information

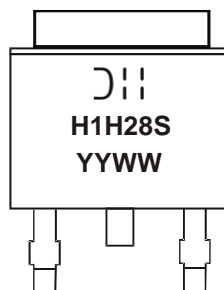

= Manufacturer's Marking  
 H1H28S = Product Type Marking Code  
 YYWW = Date Code Marking  
 YY = Last Digit of Year (ex: 15 = 2015)  
 WW = Week Code (01 to 53)

**Maximum Ratings** (@T<sub>A</sub> = +25°C, unless otherwise specified.)

| Characteristic   | Symbol           | Value                   | Unit |
|--|------------------|-------------------------|------|
| Drain-Source Voltage                                   | V <sub>DSS</sub> | 100                     | V    |
| Gate-Source Voltage                                    | V <sub>GSS</sub> | ±20                     | V    |
| Continuous Drain Current, V <sub>GS</sub> = 10V        | I <sub>D</sub>   | T <sub>C</sub> = +25°C  | 55   |
|  |                  | T <sub>C</sub> = +100°C | 39   |
| Pulsed Drain Current (10µs Pulse, Duty Cycle = 1%)     | I <sub>DM</sub>  | 58                      | A    |
| Maximum Continuous Body Diode Forward Current (Note 5) | I <sub>S</sub>   | 2.2                     | A    |
| Avalanche Current, L = 0.1mH                           | I <sub>AS</sub>  | 29                      | A    |
| Avalanche Energy, L = 0.1mH                            | E <sub>AS</sub>  | 43                      | mJ   |

**Thermal Characteristics** (@T<sub>A</sub> = +25°C, unless otherwise specified.)

| Characteristic                                   | Symbol                            | Value        | Unit |
|--|-----------------------------------|--------------|------|
| Total Power Dissipation (Note 5)                 | P <sub>D</sub>                    | 2.0          | W    |
| Thermal Resistance, Junction to Ambient (Note 5) | R <sub>θJA</sub>                  | Steady State | 74   |
|  |                                   | t < 10s      | 25   |
| Total Power Dissipation (Note 6)                 | P <sub>D</sub>                    | 3.7          | W    |
| Thermal Resistance, Junction to Ambient (Note 6) | R <sub>θJA</sub>                  | Steady State | 40   |
|  |                                   | t < 10s      | 13   |
| Thermal Resistance, Junction to Case             | R <sub>θJC</sub>                  | 1.2          | °C/W |
| Operating and Storage Temperature Range          | T <sub>J</sub> , T <sub>STG</sub> | -55 to +175  | °C   |

**Electrical Characteristics** (@T<sub>A</sub> = +25°C, unless otherwise specified.)

| Characteristic  | Symbol              | Min | Typ  | Max  | Unit | Test Condition   |
|---|---------------------|-----|------|------|------|--|
| <b>OFF CHARACTERISTICS (Note 7)</b>                     |                     |     |      |      |      |  |
| Drain-Source Breakdown Voltage                          | BV <sub>DSS</sub>   | 100 | —    | —    | V    | V <sub>GS</sub> = 0V, I <sub>D</sub> = 250µA   |
| Zero Gate Voltage Drain Current, T <sub>J</sub> = +25°C | I <sub>DSS</sub>    | —   | —    | 1    | µA   | V <sub>DS</sub> = 100V, V <sub>GS</sub> = 0V   |
| Gate-Source Leakage                                     | I <sub>GSS</sub>    | —   | —    | ±100 | nA   | V <sub>GS</sub> = ±20V, V <sub>DS</sub> = 0V   |
| <b>ON CHARACTERISTICS (Note 7)</b>                      |                     |     |      |      |      |  |
| Gate Threshold Voltage                                  | V <sub>GS(TH)</sub> | 2.0 | 2.5  | 3.3  | V    | V <sub>DS</sub> = V <sub>GS</sub> , I <sub>D</sub> = 250µA                                 |
| Static Drain-Source On-Resistance                       | R <sub>DS(ON)</sub> | —   | 20   | 28   | mΩ   | V <sub>GS</sub> = 10V, I <sub>D</sub> = 20A  |
| Diode Forward Voltage                                   | V <sub>SD</sub>     | —   | 0.7  | 1.2  | V    | V <sub>GS</sub> = 0V, I <sub>S</sub> = 1.0A  |
| <b>DYNAMIC CHARACTERISTICS (Note 8)</b>                 |                     |     |      |      |      |  |
| Input Capacitance                                       | C <sub>iss</sub>    | —   | 2245 | —    | pF   | V <sub>DS</sub> = 50V, V <sub>GS</sub> = 0V,<br>f = 1MHz                                   |
| Output Capacitance                                      | C <sub>oss</sub>    | —   | 173  | —    | pF   |  |
| Reverse Transfer Capacitance                            | C <sub>rss</sub>    | —   | 68   | —    | pF   |  |
| Gate Resistance   | R <sub>g</sub>      | —   | 1.9  | —    | Ω    | V <sub>DS</sub> = 0V, V <sub>GS</sub> = 0V, f = 1MHz                                       |
| Total Gate Charge (V <sub>GS</sub> = 10V)               | Q <sub>g</sub>      | —   | 36   | —    | nC   | V <sub>DS</sub> = 50V, I <sub>D</sub> = 20A  |
| Total Gate Charge (V <sub>GS</sub> = 6V)                | Q <sub>g</sub>      | —   | 22   | —    | nC   |  |
| Gate-Source Charge                                      | Q <sub>gs</sub>     | —   | 7.3  | —    | nC   |  |
| Gate-Drain Charge                                       | Q <sub>gd</sub>     | —   | 9.2  | —    | nC   |  |
| Turn-On Delay Time                                      | t <sub>D(ON)</sub>  | —   | 6.4  | —    | ns   | V <sub>GS</sub> = 10V, V <sub>DS</sub> = 50V,<br>R <sub>G</sub> = 3Ω, I <sub>D</sub> = 20A |
| Turn-On Rise Time                                       | t <sub>R</sub>      | —   | 5.8  | —    | ns   |  |
| Turn-Off Delay Time                                     | t <sub>D(OFF)</sub> | —   | 17.8 | —    | ns   |  |
| Turn-Off Fall Time                                      | t <sub>F</sub>      | —   | 4.8  | —    | ns   |  |
| Body Diode Reverse Recovery Time                        | t <sub>RR</sub>     | —   | 35   | —    | ns   | I <sub>F</sub> = 20A, di/dt = 100A/µs  |
| Body Diode Reverse Recovery Charge                      | Q <sub>RR</sub>     | —   | 47   | —    | nC   | I <sub>F</sub> = 20A, di/dt = 100A/µs  |

- Notes: 5. Device mounted on FR-4 substrate PC board, 2oz copper, with minimum recommended pad layout.  
6. Device mounted on FR-4 substrate PC board, 2oz copper, with 1inch square copper plate.  
7. Short duration pulse test used to minimize self-heating effect.  
8. Guaranteed by design. Not subject to product testing.

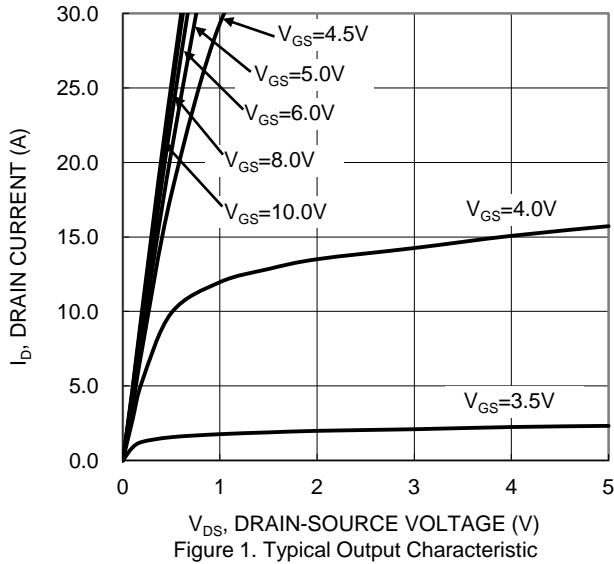

Figure 1. Typical Output Characteristic

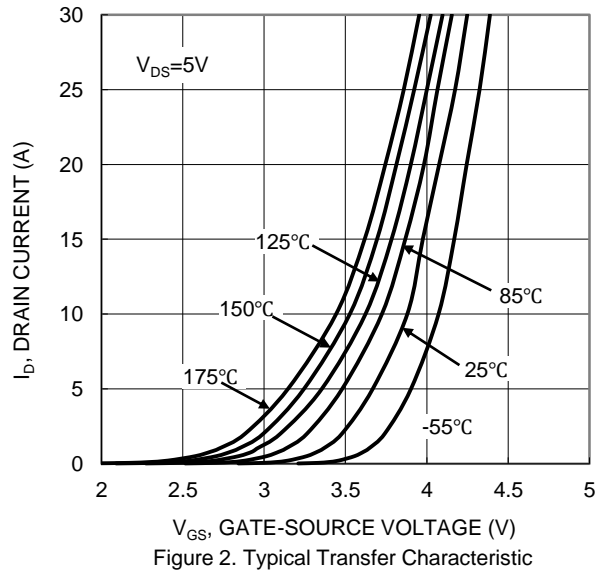

Figure 2. Typical Transfer Characteristic

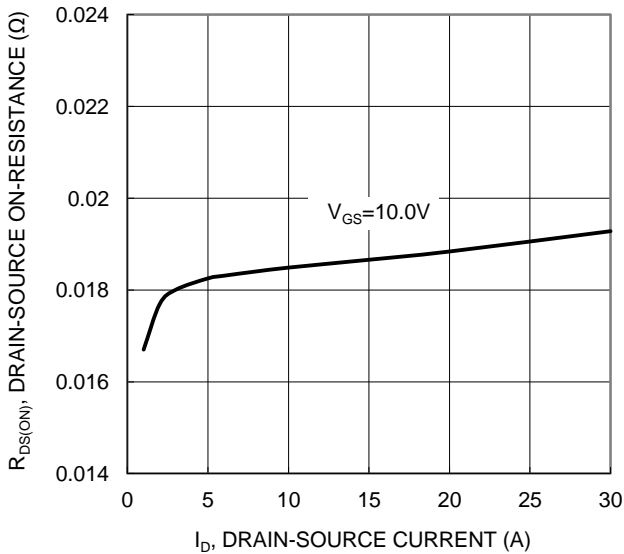

Figure 3. Typical On-Resistance vs. Drain Current and Gate Voltage

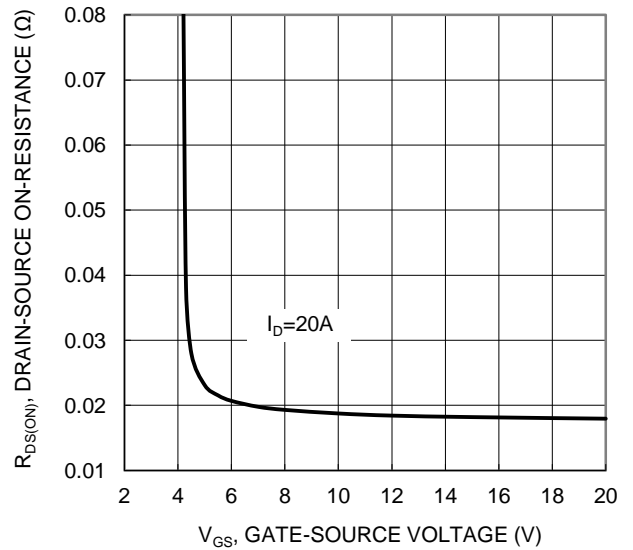

Figure 4. Typical Transfer Characteristic

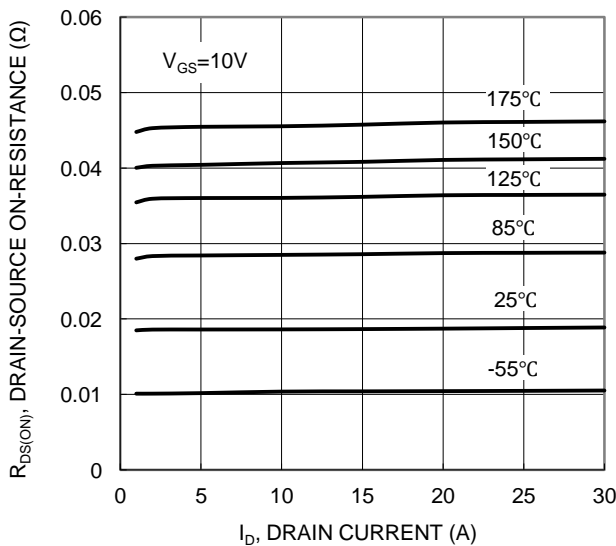

Figure 5. Typical On-Resistance vs. Drain Current and Temperature

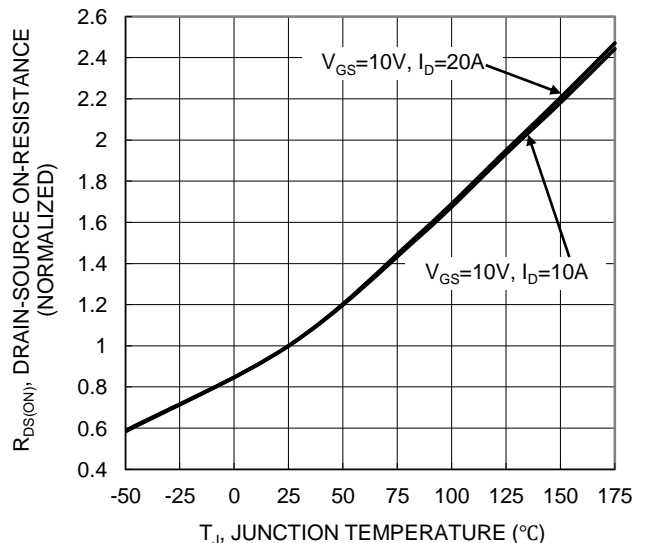

Figure 6. On-Resistance Variation with Temperature

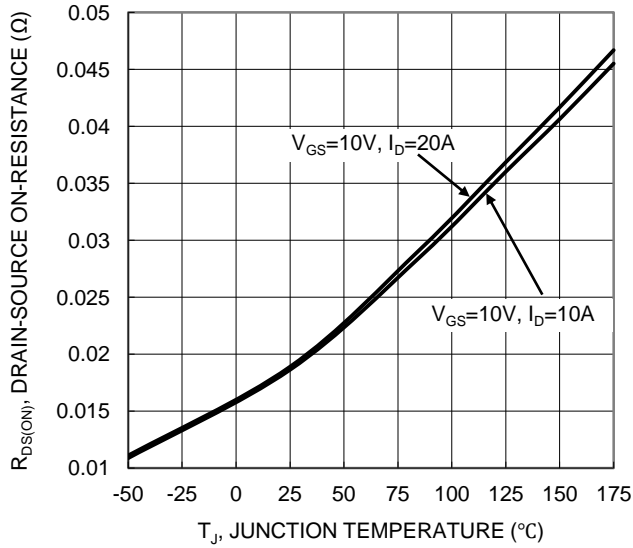

Figure 7. On-Resistance Variation with Temperature

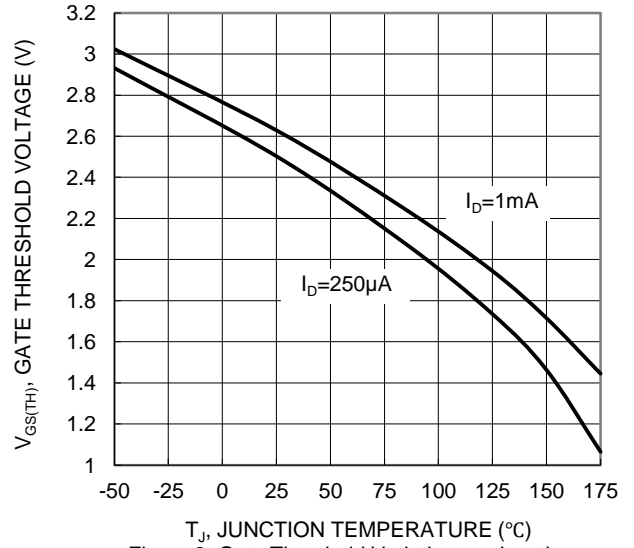

Figure 8. Gate Threshold Variation vs. Junction Temperature

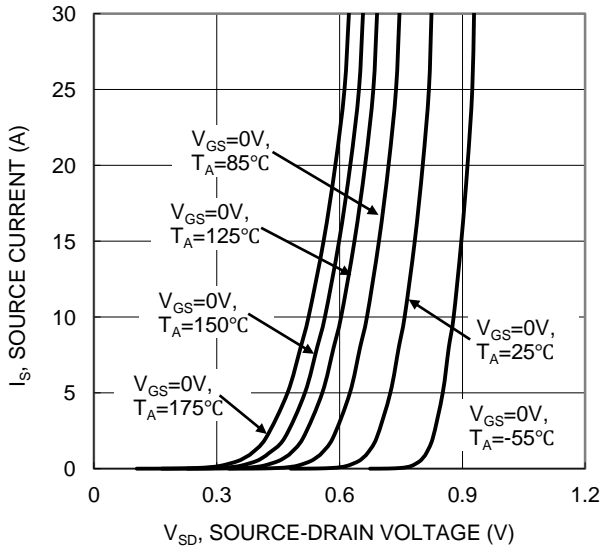

Figure 9. Diode Forward Voltage vs. Current

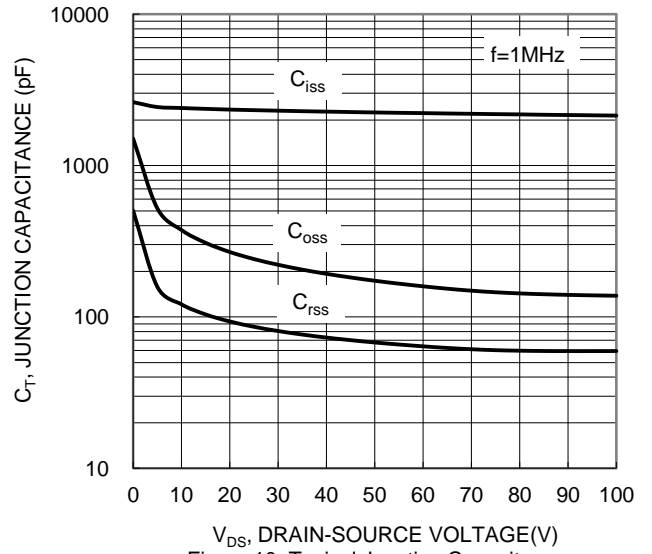

Figure 10. Typical Junction Capacitance

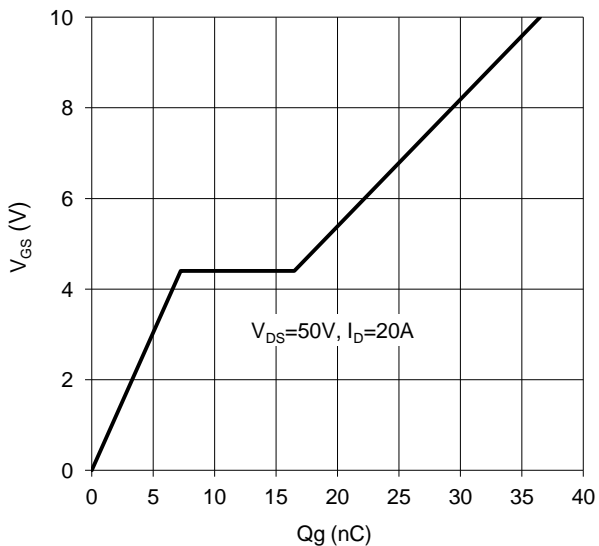

Figure 11. Gate Charge

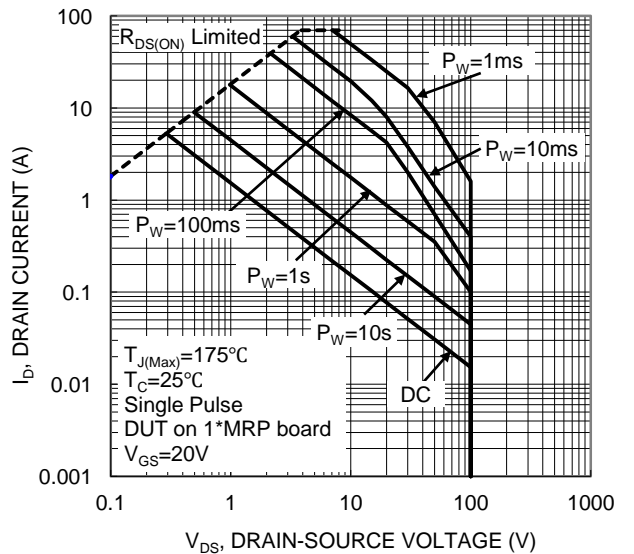

Figure 12. SOA, Safe Operation Area

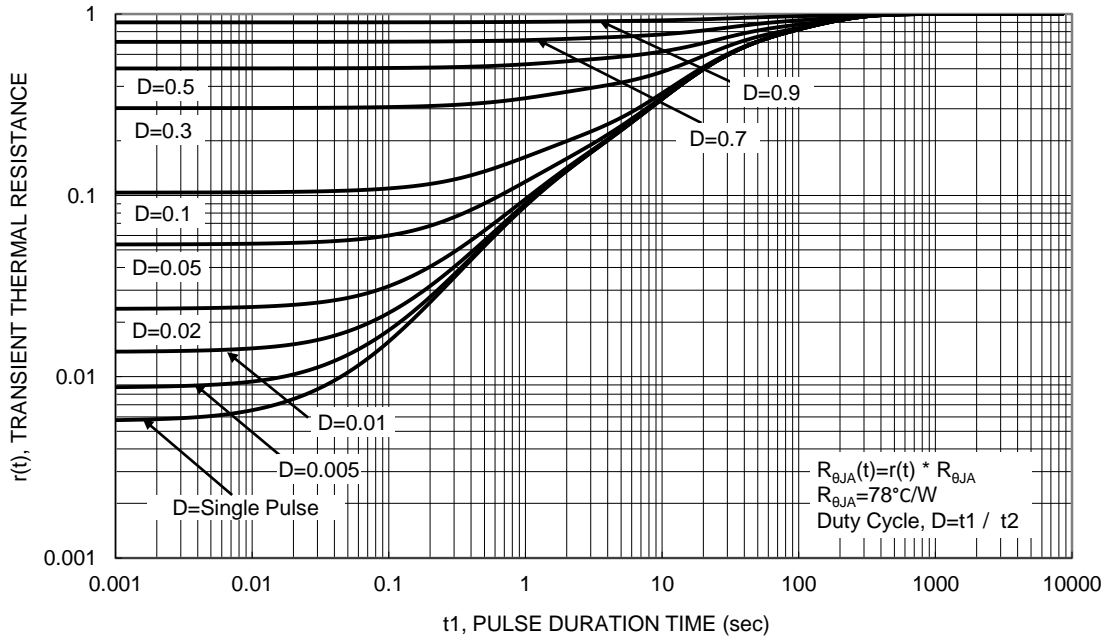
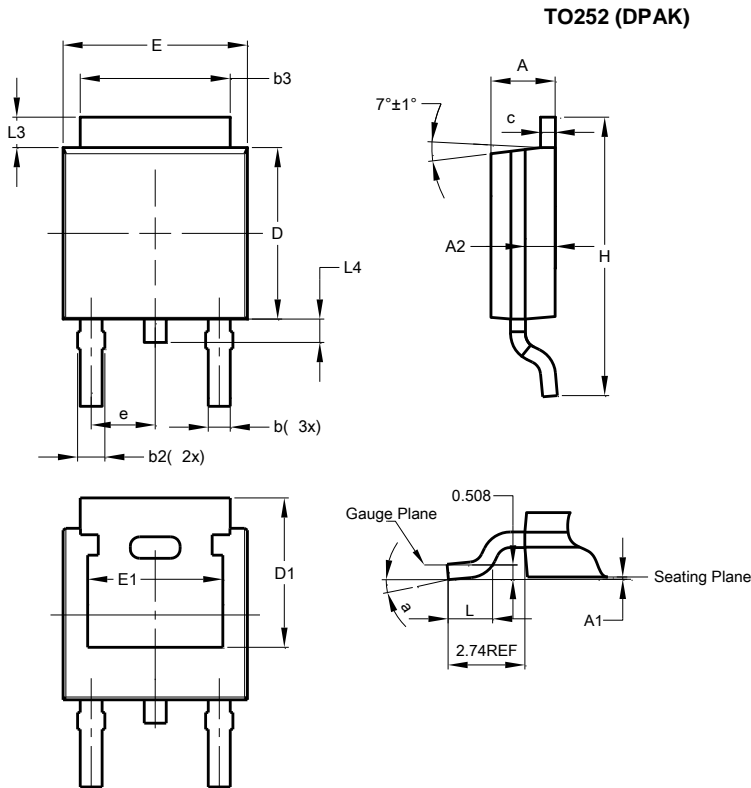

Figure 13. Transient Thermal Resistance

## Package Outline Dimensions

Please see AP02002 at <http://www.diodes.com/datasheets/ap02002.pdf> for the latest version.



| TO252 (DPAK)         |      |       |       |
|----------------------|------|-------|-------|
| Dim                  | Min  | Max   | Typ   |
| A                    | 2.19 | 2.39  | 2.29  |
| A1                   | 0.00 | 0.13  | 0.08  |
| A2                   | 0.97 | 1.17  | 1.07  |
| b                    | 0.64 | 0.88  | 0.783 |
| b2                   | 0.76 | 1.14  | 0.95  |
| b3                   | 5.21 | 5.46  | 5.33  |
| c                    | 0.45 | 0.58  | 0.531 |
| D                    | 6.00 | 6.20  | 6.10  |
| D1                   | 5.21 | -     | -     |
| e                    | -    | -     | 2.286 |
| E                    | 6.45 | 6.70  | 6.58  |
| E1                   | 4.32 | -     | -     |
| H                    | 9.40 | 10.41 | 9.91  |
| L                    | 1.40 | 1.78  | 1.59  |
| L3                   | 0.88 | 1.27  | 1.08  |
| L4                   | 0.64 | 1.02  | 0.83  |
| a                    | 0°   | 10°   | -     |
| All Dimensions in mm |      |       |       |

## Suggested Pad Layout

Please see AP02001 at <http://www.diodes.com/datasheets/ap02001.pdf> for the latest version.

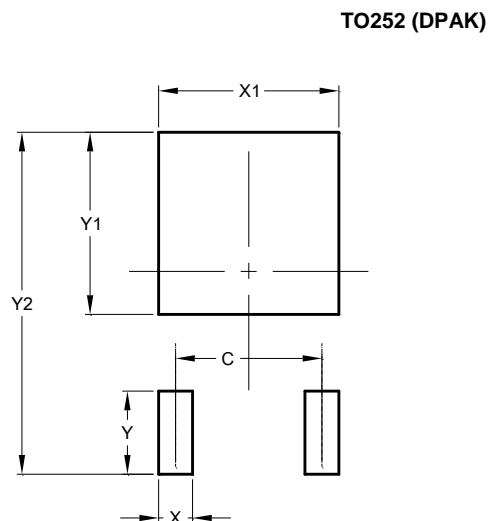

| Dimensions | Value (in mm) |
|------------|---------------|
| C          | 4.572         |
| X          | 1.060         |
| X1         | 5.632         |
| Y          | 2.600         |
| Y1         | 5.700         |
| Y2         | 10.700        |

**IMPORTANT NOTICE**

DIODES INCORPORATED MAKES NO WARRANTY OF ANY KIND, EXPRESS OR IMPLIED, WITH REGARDS TO THIS DOCUMENT, INCLUDING, BUT NOT LIMITED TO, THE IMPLIED WARRANTIES OF MERCHANTABILITY AND FITNESS FOR A PARTICULAR PURPOSE (AND THEIR EQUIVALENTS UNDER THE LAWS OF ANY JURISDICTION).

Diodes Incorporated and its subsidiaries reserve the right to make modifications, enhancements, improvements, corrections or other changes without further notice to this document and any product described herein. Diodes Incorporated does not assume any liability arising out of the application or use of this document or any product described herein; neither does Diodes Incorporated convey any license under its patent or trademark rights, nor the rights of others. Any Customer or user of this document or products described herein in such applications shall assume all risks of such use and will agree to hold Diodes Incorporated and all the companies whose products are represented on Diodes Incorporated website, harmless against all damages.

Diodes Incorporated does not warrant or accept any liability whatsoever in respect of any products purchased through unauthorized sales channel. Should Customers purchase or use Diodes Incorporated products for any unintended or unauthorized application, Customers shall indemnify and hold Diodes Incorporated and its representatives harmless against all claims, damages, expenses, and attorney fees arising out of, directly or indirectly, any claim of personal injury or death associated with such unintended or unauthorized application.

Products described herein may be covered by one or more United States, international or foreign patents pending. Product names and markings noted herein may also be covered by one or more United States, international or foreign trademarks.

This document is written in English but may be translated into multiple languages for reference. Only the English version of this document is the final and determinative format released by Diodes Incorporated.

**LIFE SUPPORT**

Diodes Incorporated products are specifically not authorized for use as critical components in life support devices or systems without the express written approval of the Chief Executive Officer of Diodes Incorporated. As used herein:

A. Life support devices or systems are devices or systems which:

1. are intended to implant into the body, or
2. support or sustain life and whose failure to perform when properly used in accordance with instructions for use provided in the labeling can be reasonably expected to result in significant injury to the user.

B. A critical component is any component in a life support device or system whose failure to perform can be reasonably expected to cause the failure of the life support device or to affect its safety or effectiveness.

Customers represent that they have all necessary expertise in the safety and regulatory ramifications of their life support devices or systems, and acknowledge and agree that they are solely responsible for all legal, regulatory and safety-related requirements concerning their products and any use of Diodes Incorporated products in such safety-critical, life support devices or systems, notwithstanding any devices- or systems-related information or support that may be provided by Diodes Incorporated. Further, Customers must fully indemnify Diodes Incorporated and its representatives against any damages arising out of the use of Diodes Incorporated products in such safety-critical, life support devices or systems.

Copyright © 2015, Diodes Incorporated

[www.diodes.com](http://www.diodes.com)



Компания «ЭлектроПласт» предлагает заключение долгосрочных отношений при поставках импортных электронных компонентов на взаимовыгодных условиях!

Наши преимущества:

- Оперативные поставки широкого спектра электронных компонентов отечественного и импортного производства напрямую от производителей и с крупнейших мировых складов;
- Поставка более 17-ти миллионов наименований электронных компонентов;
- Поставка сложных, дефицитных, либо снятых с производства позиций;
- Оперативные сроки поставки под заказ (от 5 рабочих дней);
- Экспресс доставка в любую точку России;
- Техническая поддержка проекта, помощь в подборе аналогов, поставка прототипов;
- Система менеджмента качества сертифицирована по Международному стандарту ISO 9001;
- Лицензия ФСБ на осуществление работ с использованием сведений, составляющих государственную тайну;
- Поставка специализированных компонентов (Xilinx, Altera, Analog Devices, Intersil, Interpoint, Microsemi, Aeroflex, Peregrine, Syfer, Eurofarad, Texas Instrument, Miteq, Cobham, E2V, MA-COM, Hittite, Mini-Circuits, General Dynamics и др.);

Помимо этого, одним из направлений компании «ЭлектроПласт» является направление «Источники питания». Мы предлагаем Вам помощь Конструкторского отдела:

- Подбор оптимального решения, техническое обоснование при выборе компонента;
- Подбор аналогов;
- Консультации по применению компонента;
- Поставка образцов и прототипов;
- Техническая поддержка проекта;
- Защита от снятия компонента с производства.



#### Как с нами связаться

**Телефон:** 8 (812) 309 58 32 (многоканальный)

**Факс:** 8 (812) 320-02-42

**Электронная почта:** [org@eplast1.ru](mailto:org@eplast1.ru)

**Адрес:** 198099, г. Санкт-Петербург, ул. Калинина, дом 2, корпус 4, литера А.