



## **MachXO3L Breakout Board Evaluation Kit**

---

**User Guide**

## Introduction

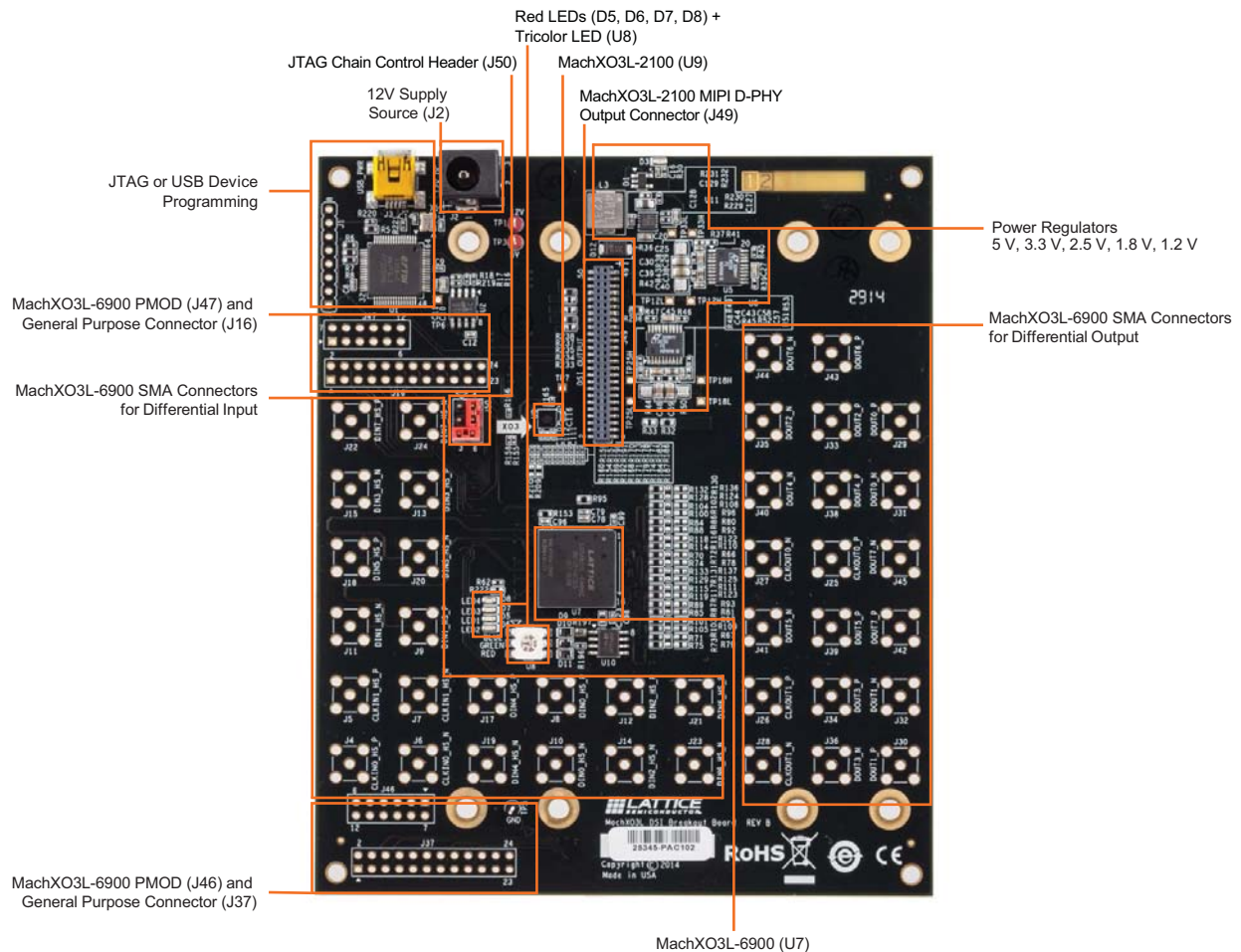
The MachXO3L Breakout Board Evaluation Kit focuses on providing an environment to evaluate high speed source synchronous interfaces with the Lattice MachXO3L-2100 and MachXO3L-6900 products in both 49-ball WLCSP and 256-ball caBGA packages respectively.

The MachXO3L Breakout Board contains two sections for development. The first section of the board features the MachXO3L-2100 which is optimized for MIPI D-PHY receiver and MIPI D-PHY transmitter interfaces with up to four data lanes and one clock lane each. The second section of the board features the MachXO3L-6900. This section provides a flexible IO evaluation environment for MIPI D-PHY, SubLVDS, FPD-LINK, FPC-LINK as well as other source synchronous type protocols. The IO of the MachXO3L-6900 provides eight high speed data and two high speed clock interfaces in both transmit and receive directions. Connection to these interfaces is available through SMAs for signal integrity and performance evaluation.

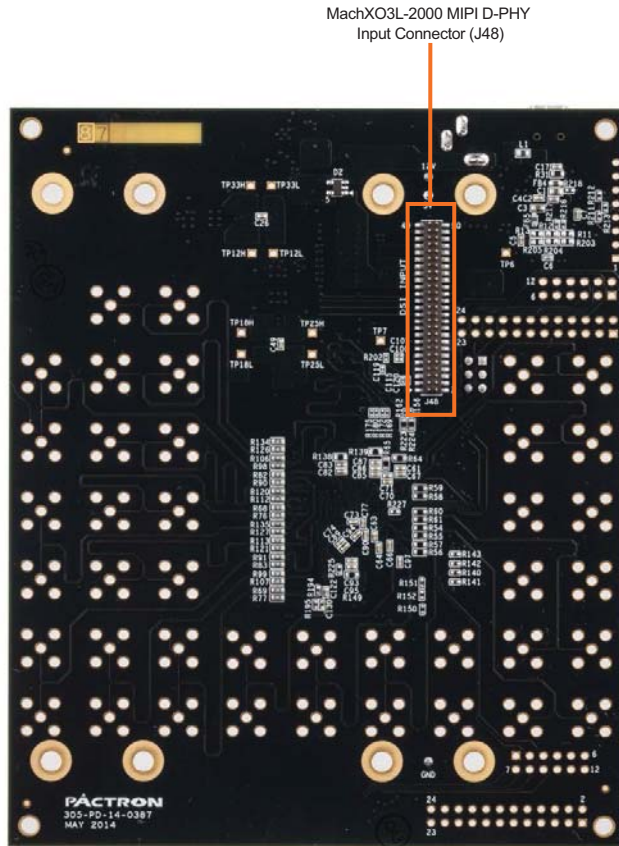
## Evaluation Kit Contents

- MachXO3L Breakout Board
- Pre-loaded Demo
- Mini USB Cable
- QuickStart Guide

**Figure 1. MachXO3L Breakout Board (Top Side)**



**Figure 2. MachXO3L Breakout Board (Bottom Side)**

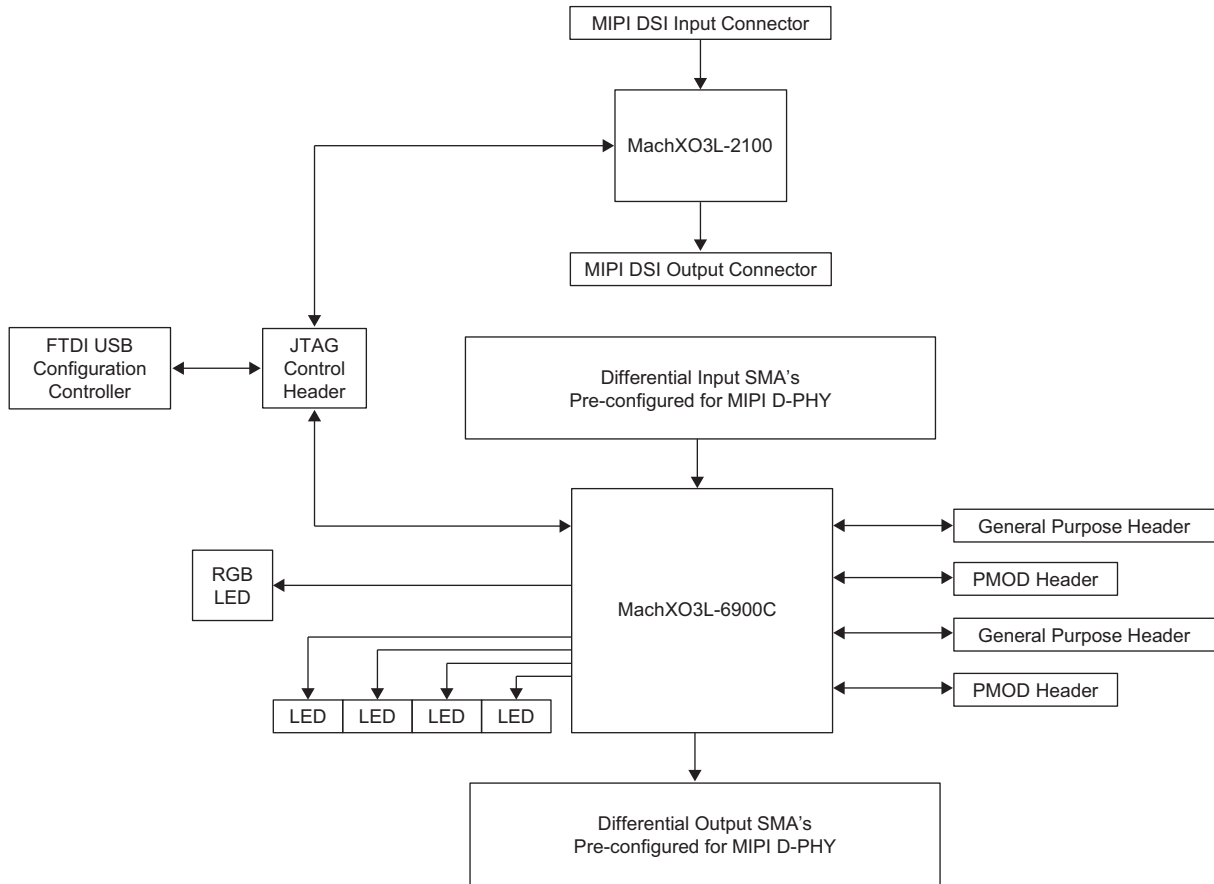


## Overview

The MachXO3L Breakout Board allows for multi-device testing and scalability by providing a larger MachXO3L-6900 and a smaller MachXO3L-2100 device. The MachXO3L-6900 has two high speed clock and eight high speed data inputs and outputs. By default these ports are configured for MIPI D-PHY IO support, but can be modified for various IO options, such as LVDS, SubLVDS and CMOS. The MachXO3L-6900 also has four general purpose IO headers, two of which have the ability to connect with Digilent PMOD interface boards. Additionally, the MachXO3L-6900 device has the ability to control four general purpose LEDs and one tri-color RGB LED.

The MachXO3L-2100 is attached to two connectors providing four data and one clock lanes configured for MIPI D-PHY going in to and out of the FPGA. The pinout for the MachXO3L-2100 is optimized for low cost and small form factor by operating only off of 1.2 V and 3.3 V CMOS IO rails.

Figure 3. MachXO3L Breakout Board Functional Block Diagram



## MachXO3L Devices

The MachXO3L Breakout Board features both the MachXO3L-6900 in 256-ball caBGA package and the MachXO3L-2100 in 49-ball WLCSP package. These devices feature 2100 and 6900 LUTs and 74 and 240 kbits of embedded block RAM respectively. Both of these devices feature a variety of features and programmability. For more information on the capabilities of each device see DS1047, [MachXO3 Family Data Sheet](#).

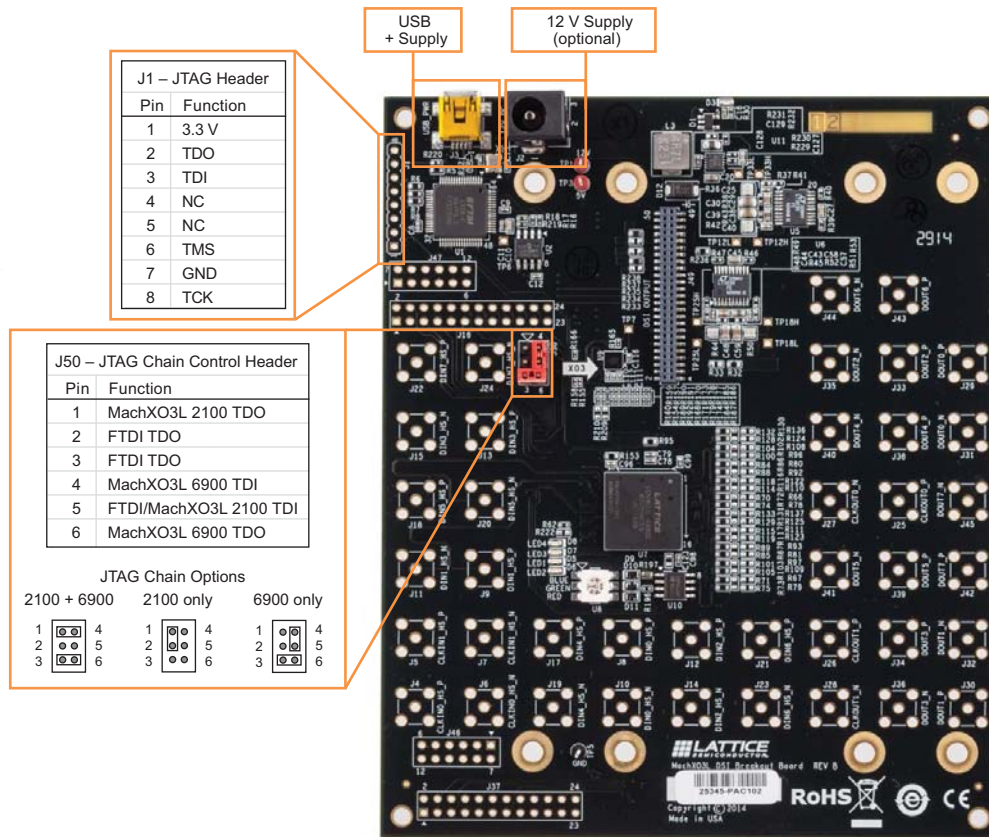
## Connector Descriptions

### Configuration

The MachXO3L-2100 and MachXO3L-6900 parts can be programmed via JTAG through USB port or standalone JTAG header. The USB path uses a FT2232H FTDI part to convert USB to JTAG. The standalone JTAG header can be used to program the devices using the Lattice Programming Cable. In order to use the stand alone JTAG header R5, R6, R7 and R8 to remove the FTDI part from the JTAG chain.

Power can be supplied to the board via mini USB port, 12 V power supply, from a separate board through the J48 DSI input connector or any combination of the three.

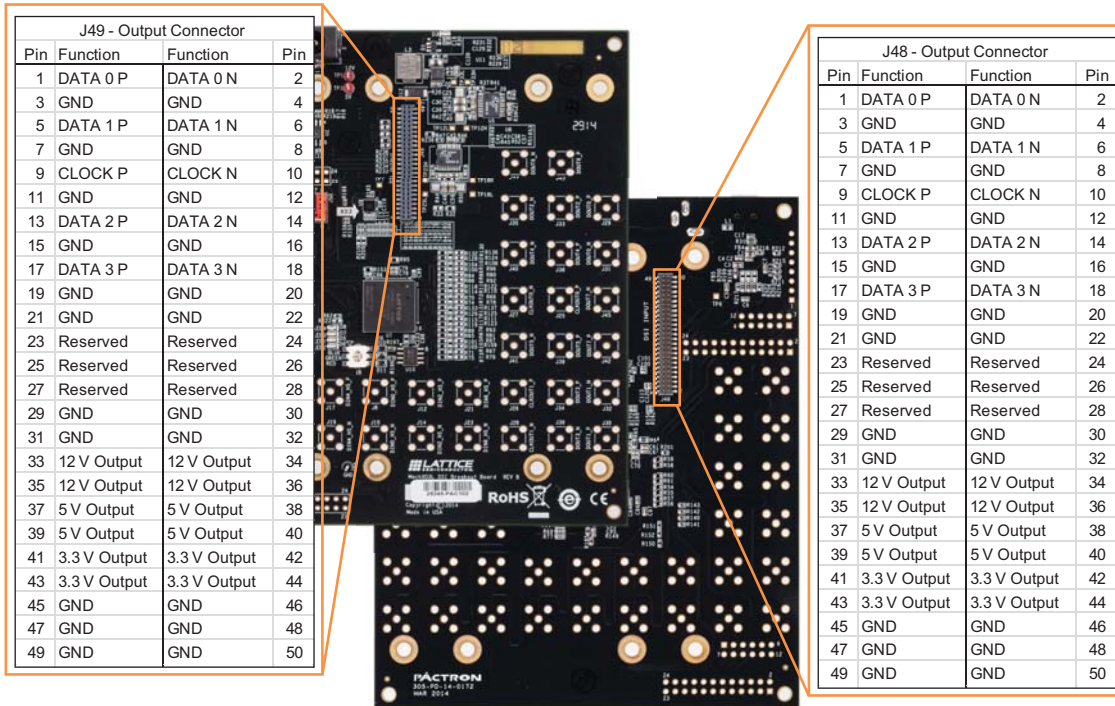
Figure 4. Configuration Connectors



## MachXO3L-2100 MIPI D-PHY Connectors

The MachXO3L-2100 has input and output connectors capable of receiving and transmitting MIPI D-PHY, DSI or CSI-2 data. The connectors are also capable of other IO standards with proper board modifications. Power can be supplied to the MachXO3L board from the bottom input connector if desired. Similarly, power can be supplied from the MachXO3L to any attached board through the top output connector.

**Figure 5. MachXO3L-2100 MIPI D-PHY Connectors**

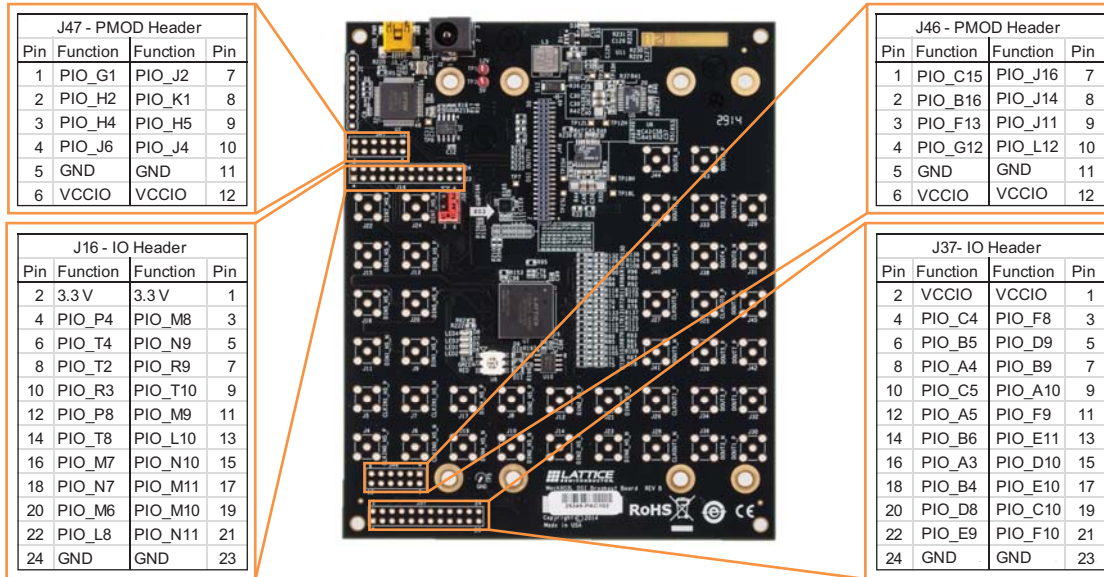




## MachXO3L-6900 PMOD and General Purpose Connectors

Two 0.1 inch 24-pin headers are available as general purpose connectors. Two 0.1 inch 12-pin headers are also available either for general purpose or for use with Digilent PMOD boards.

**Figure 6. MachXO3L-6900 PMOD and General Purpose Connectors**



## MachXO3L-6900 Input and Output SMA Connectors

The MachXO3L-6900 has 10 input SMA's on bank 2 and 10 output SMA's on bank 0. On the input side, two SMA's are connected to edge clock inputs allowing for high speed gearing. On the input side, the additional eight SMA connections are connect to A/B pairs to support 1:8 gearing ratios. The clock and data lanes 0 and 1 have additional 50 ohm resistors connected to the P and N channels. These 50 ohm resistors are connected to bank 3 at 1.2V to support MIPI D-PHY contention detect and termination options.

On the transmit side each of the FPGA to SMA paths contain a resistor divider circuit. By default, the external resistor circuit is configured to support MIPI D-PHY in SLVS-200 and 1.2 V CMOS. The external circuit provides other options such as subLVDS, and AC coupling options by providing additional board component pads for such modifications.

## Software Requirements

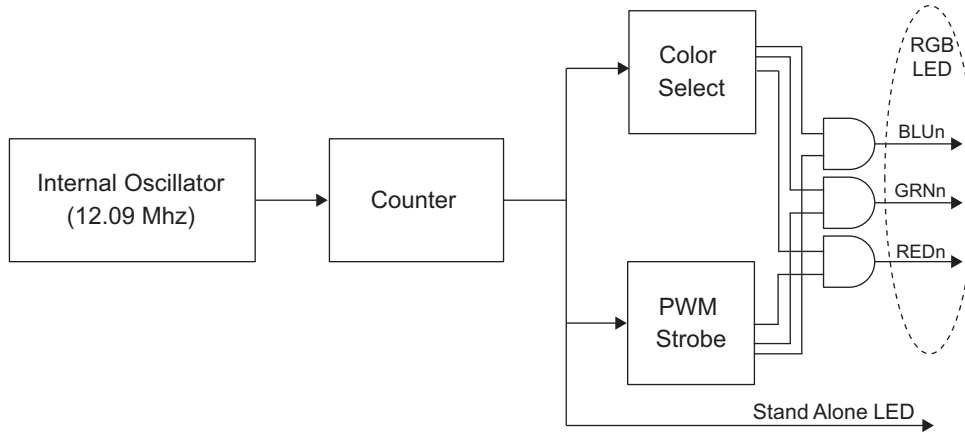
You should install the following software before you begin to develop new designs for the MachXO3L Breakout Board:

- Lattice Diamond® design software
- Diamond Standalone Programmer

## Demonstration Design

Lattice provides a simple, pre-programmed demo to illustrate basic operation of the MachXO3L device. The design flashes the red LEDs as well as the RGB LED. The design utilizes the internal oscillator operating at 12.09 MHz. A counter is designed to slow down the clock and light up the individual LEDs. The demonstration design automatically starts on a newly purchased board when power is applied.

Figure 7. Demonstration Design Block Diagram



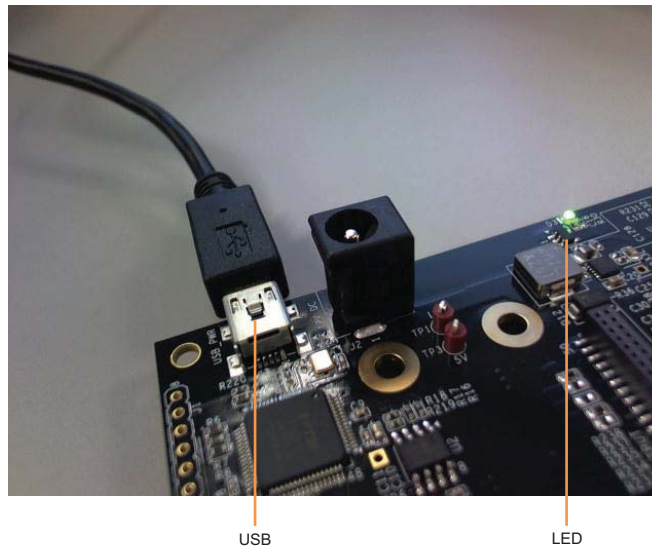
## Download Demo Designs

The LED demo is preprogrammed into the Breakout Board, however over time it is likely your board will be loaded with a different design. Lattice distributes source and programming files for demonstration designs compatible with the MachXO3L Breakout Board. The Lattice Diamond project and Verilog source code for the MachXO3L Breakout Board example design can be obtained at [www.latticesemi.com](http://www.latticesemi.com).

## Programming Demonstration Design

1. Plug in USB Cable to USB J3 connector. Check that D3 LED is ON.

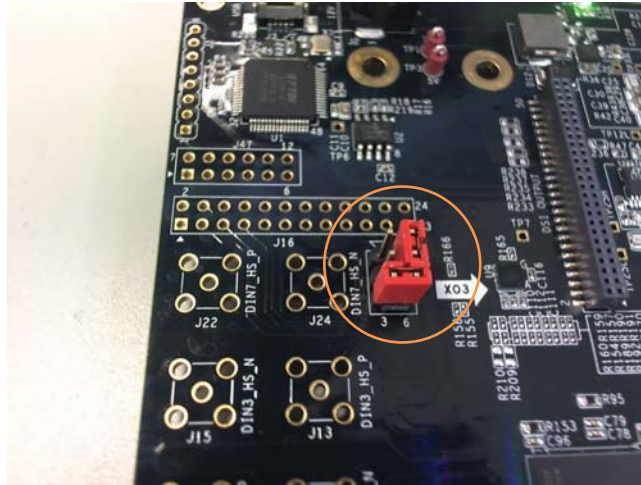
Figure 8. USB and D3 LED



2. Place a jumper on pins 4-5 and another jumper on pins 3-6 of the J50 JTAG header.

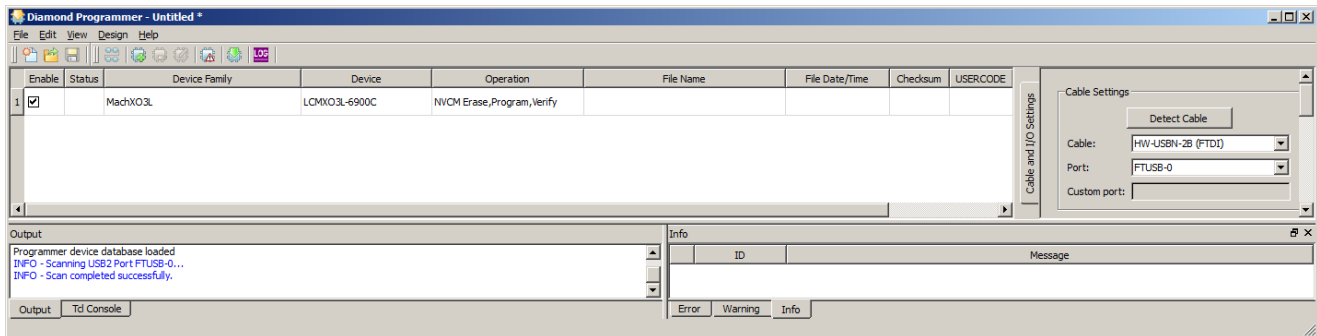


**Figure 9. Pins 3-6 and J50 JTAG Header**



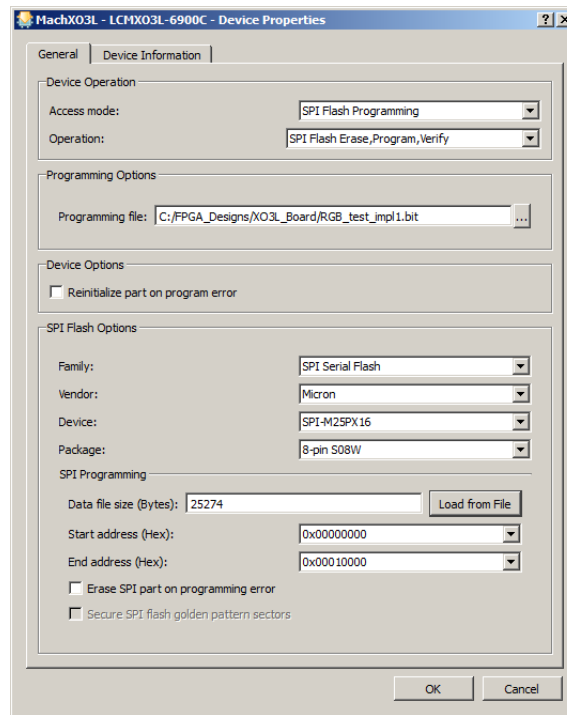
3. Open Diamond Programmer Version 3.2 (or higher) and click **OK**. The board scans and the LCMXO3L-6900C device becomes available for programming.

**Figure 10. LCMXO3L-6900C Device for Programming**



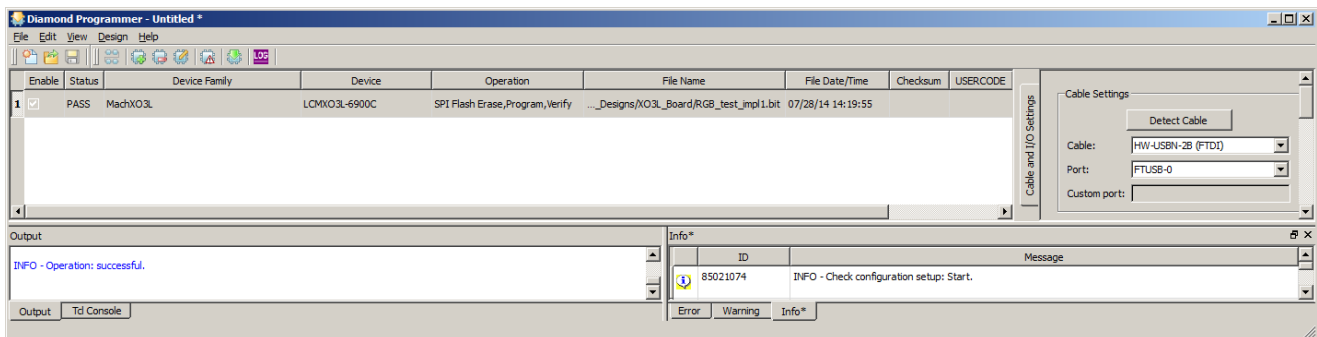
4. Double-click under Operation. The Device Properties dialog box opens.

Figure 11. SPI Flash Programming Access Mode



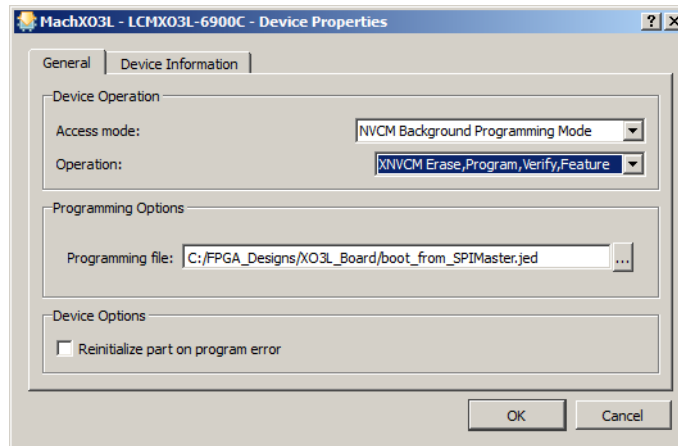
5. Select **SPI Flash Programming** in Access Mode.
6. Select the programming file *RGB\_test\_impl1.bit*.
7. Set all the SPI Flash Options as seen in Figure 23 and click **Load from File** to retrieve the data file size. Then click **OK**.
8. Click **Design > Program**. The External SPI Flash Programming operation completes successfully.

Figure 12. Operation Verified as Successful



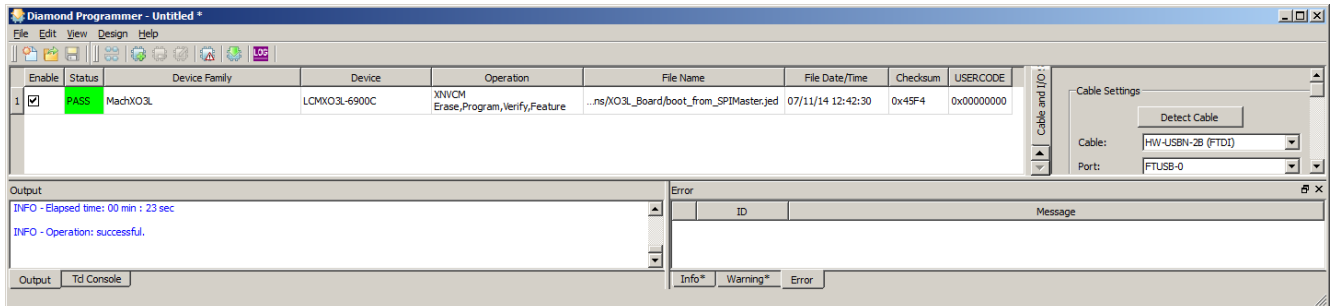
9. Double-click under Operation. The Device Properties dialog box opens.

Figure 13. XNVCM Erase, Program, Verify, Feature Access Mode



10. Select **XNVCM Erase, Program, Verify, Feature** in Access Mode.
11. Select the programming file `boot_from_SPIMaster.jed` and click **OK**.
12. Click **Design> Program**. In the Output pane, verify that *INFO – Operation: successful* is displayed.

Figure 14. Operation Verified as Successful



13. Recycle power by unplugging and re-plugging in the USB cable. The Red LEDs and RGB LEDs start flashing.

## Storage and Handling

Static electricity can shorten the lifespan of electronic components. Observe these tips to prevent damage that could occur from electro-static discharge:

- Use anti-static precautions such as operating on an anti-static mat and wearing an anti-static wrist-band.
- Store the evaluation board in the packaging provided.
- Touch a metal USB housing to equalize voltage potential between you and the board.

## Ordering Information

The MachXO3L breakout board can be ordered in two different forms. The MachXO3L SMA Breakout Board has all of the SMA's populated and the DSI connectors (J48 and J49) depopulated. The MachXO3L DSI Breakout Board has all of the SMA's de-populated and the DSI connectors (J48 and J49) populated.

**Figure 15. MachXO3L SMA Breakout Board**

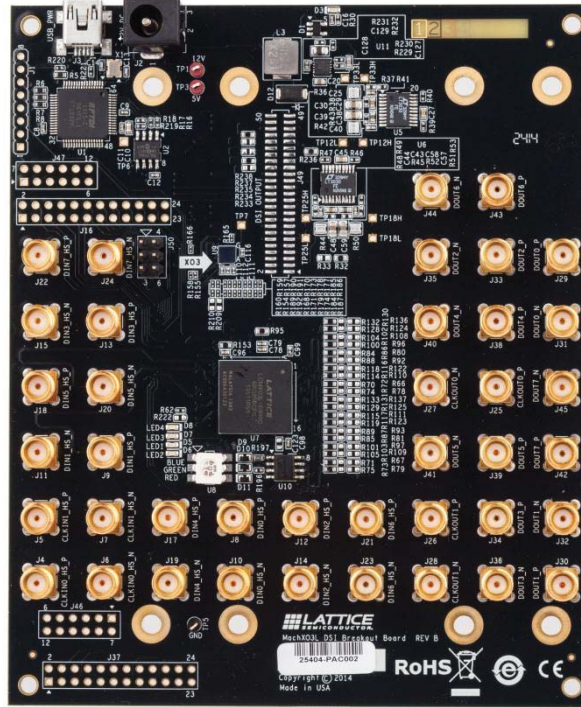
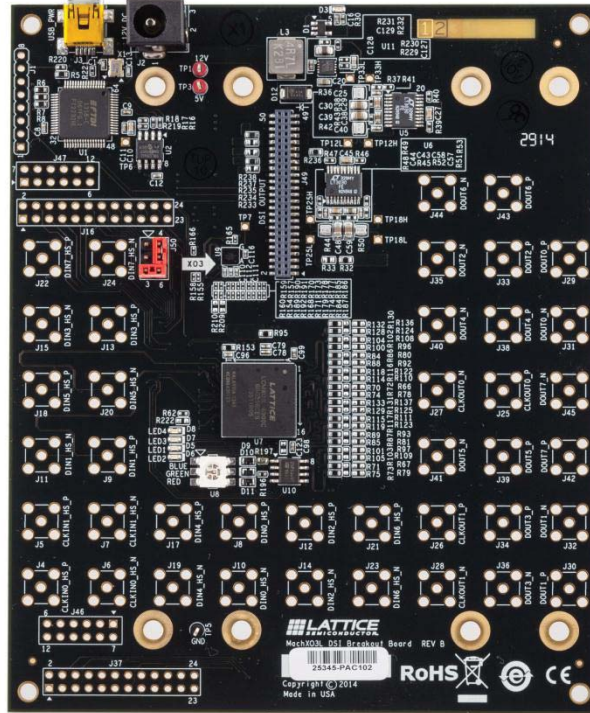



Figure 16. MachXO3L DSI Breakout Board



Description	Ordering Part Number	China RoHS Environment-Friendly Use Period (EFUP)
MachXO3L SMA Breakout Board	LCMX03L-SMA-EVN	
MachXO3L DSI Breakout Board	LCMX03L-DSI-EVN	

### Technical Support Assistance

e-mail: [techsupport@latticesemi.com](mailto:techsupport@latticesemi.com)

Internet: [www.latticesemi.com](http://www.latticesemi.com)

### Revision History

Date	Version	Change Summary
January 2015	1.1	Updated <a href="#">Appendix A. Schematic Diagrams</a> . Revised <a href="#">Figure 19</a> , Board Power.
August 2014	1.0	Initial release.

© 2015 Lattice Semiconductor Corp. All Lattice trademarks, registered trademarks, patents, and disclaimers are as listed at [www.latticesemi.com/legal](http://www.latticesemi.com/legal). All other brand or product names are trademarks or registered trademarks of their respective holders. The specifications and information herein are subject to change without notice.

## Appendix A. Schematic Diagrams

Figure 17. Block Diagram

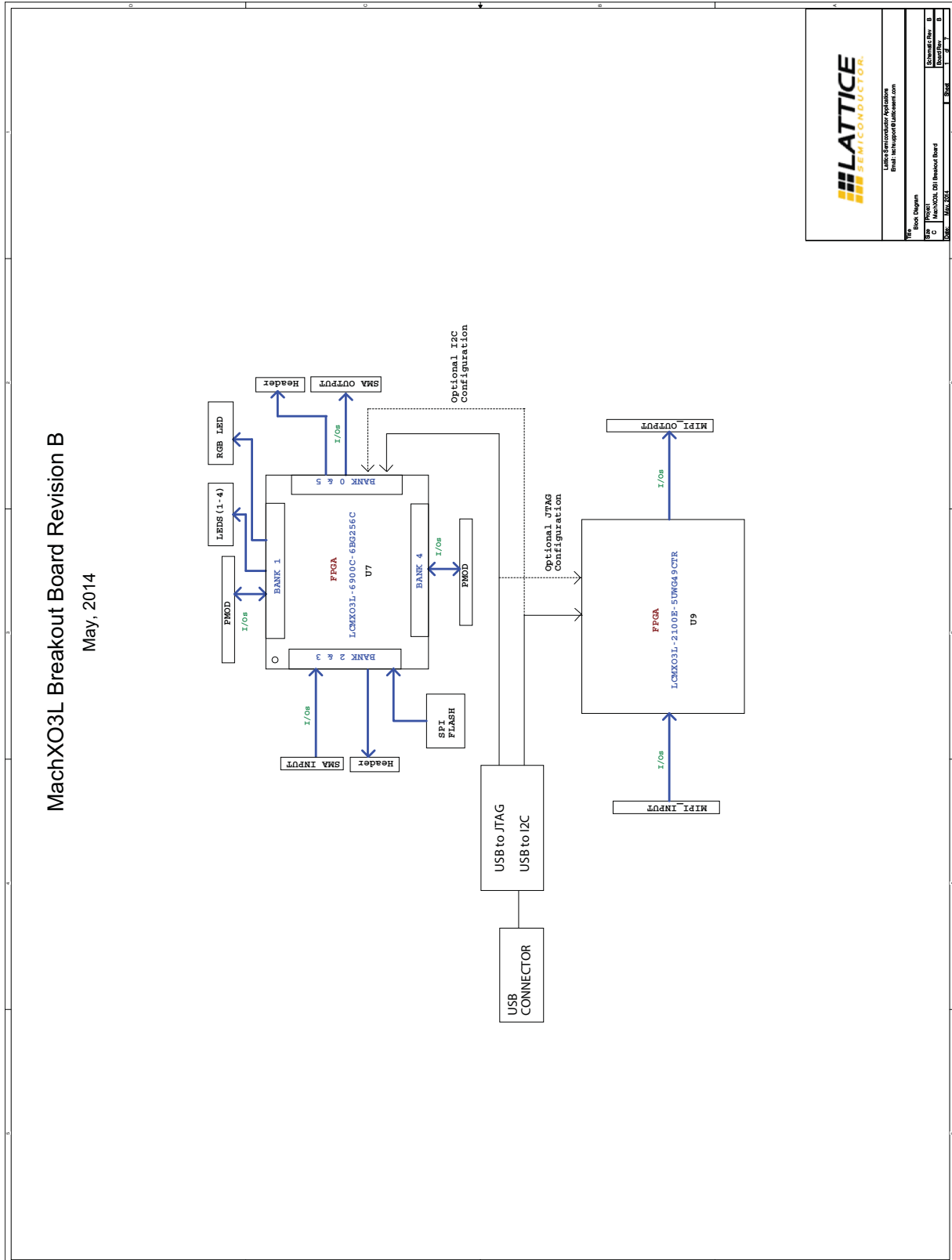
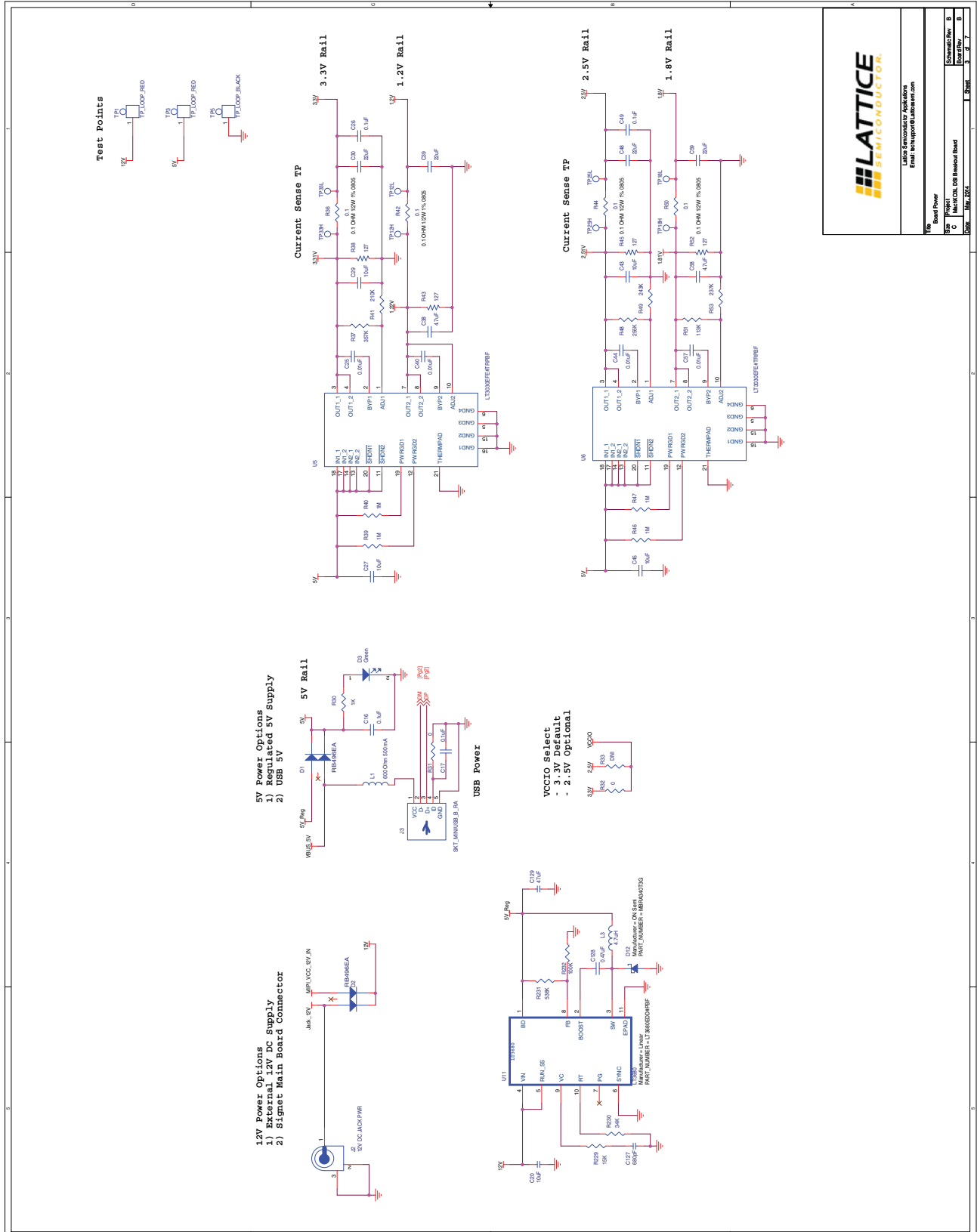






Figure 19. Board Power



**LATTICE**  
SEMICONDUCTOR

Lattice Semiconductor Corporation  
Email: techsupport@lattice.com

Rev: Board Power  
Part: MachXO3L DSB Breakout Board  
Date: May 2014

1	2	3	4	5	6	7	8
9	10	11	12	13	14	15	16

Figure 20. DSI: SMA\_INPUT

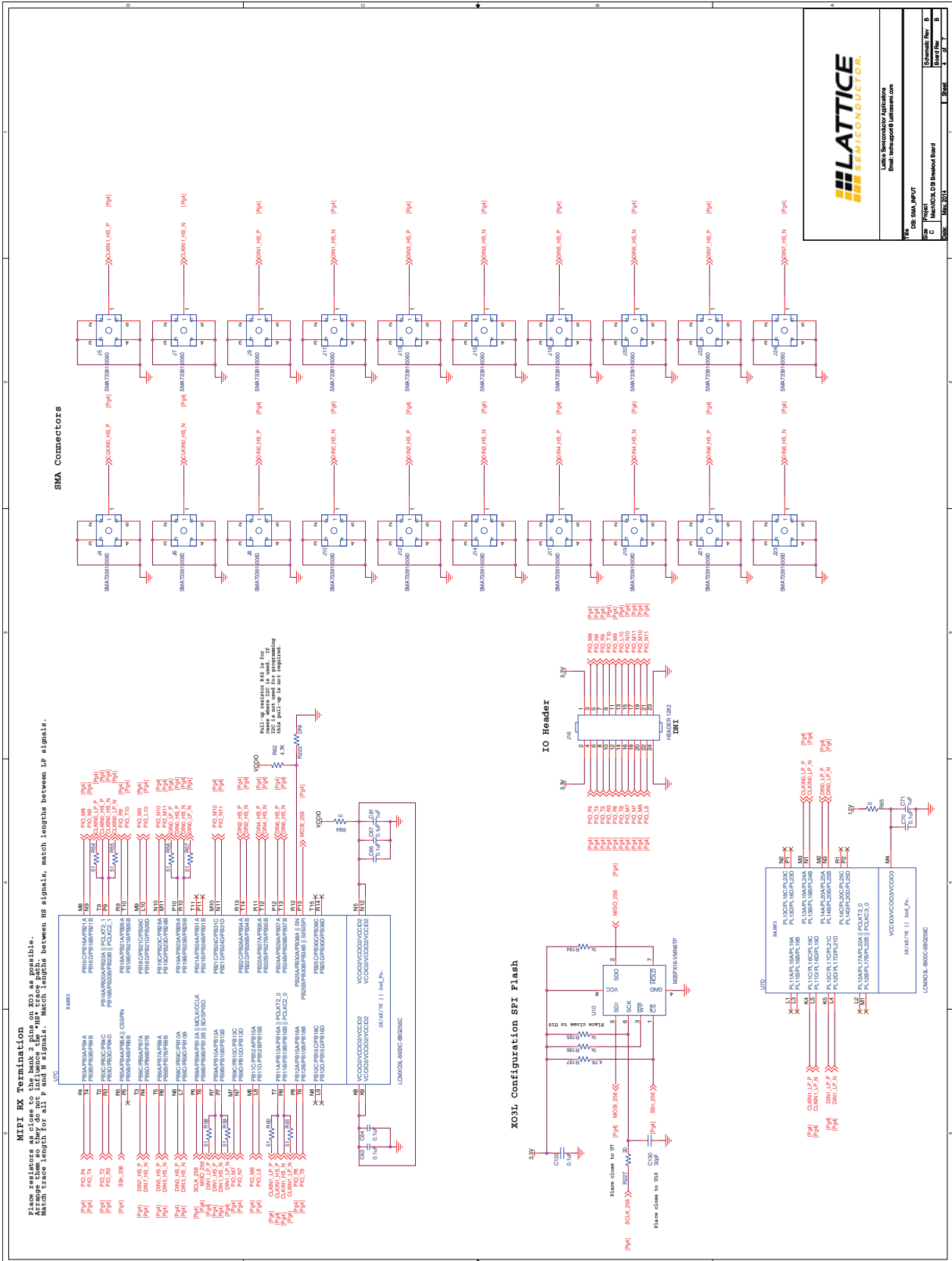


Figure 21. DSI: SMA\_OUTPUT

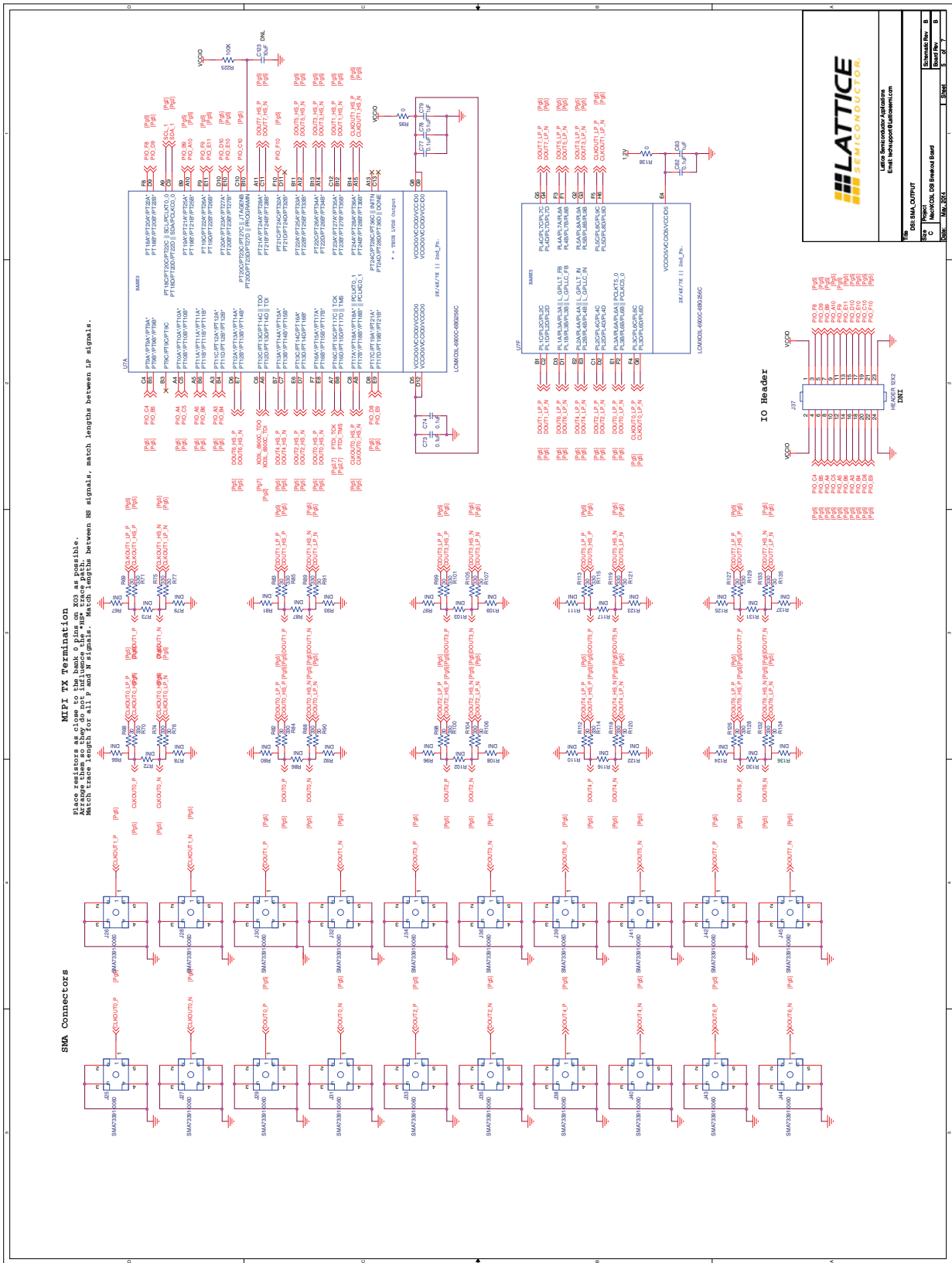
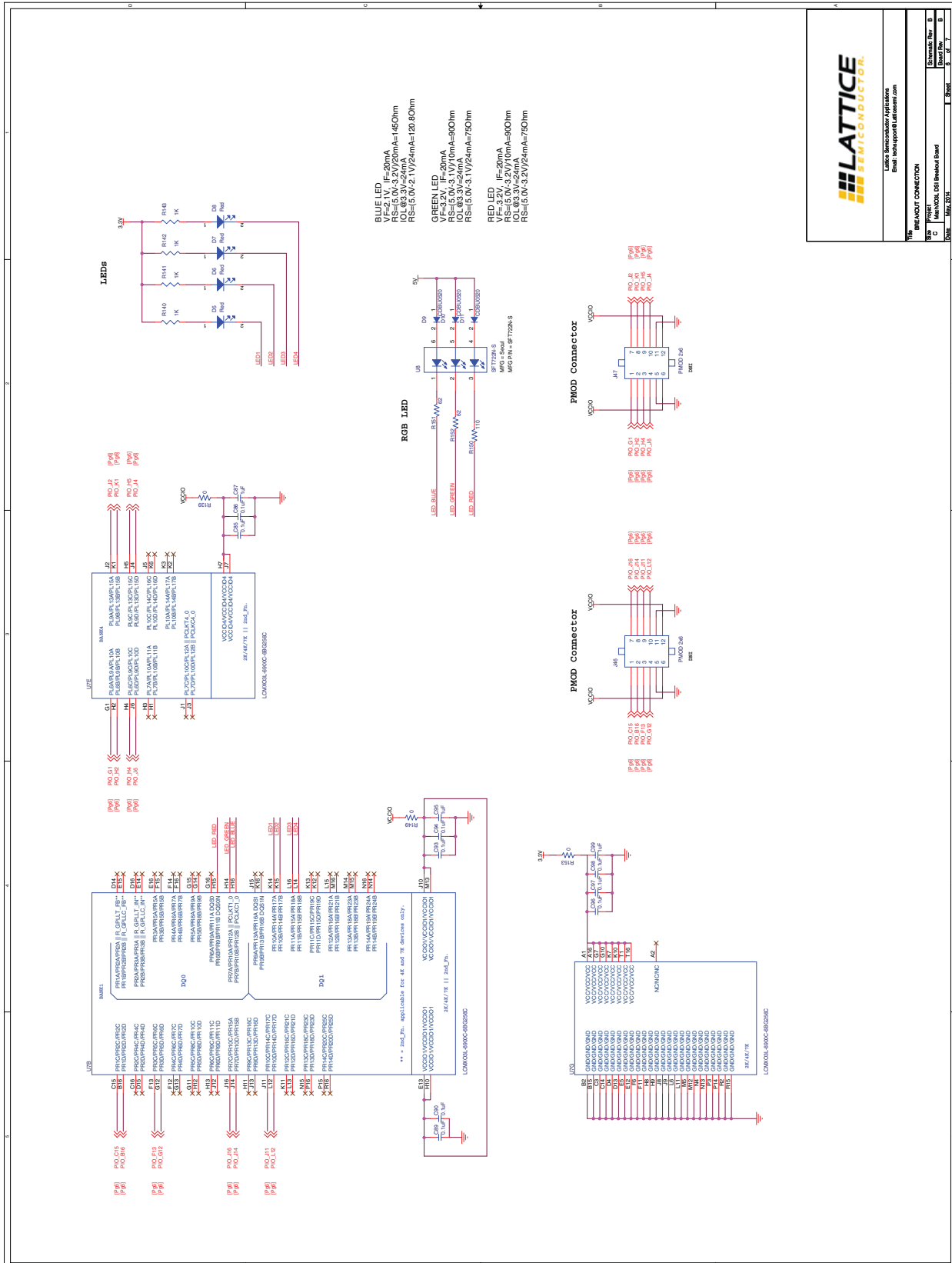


Figure 22. Breakout Connection



**LATTICE SEMICONDUCTOR**

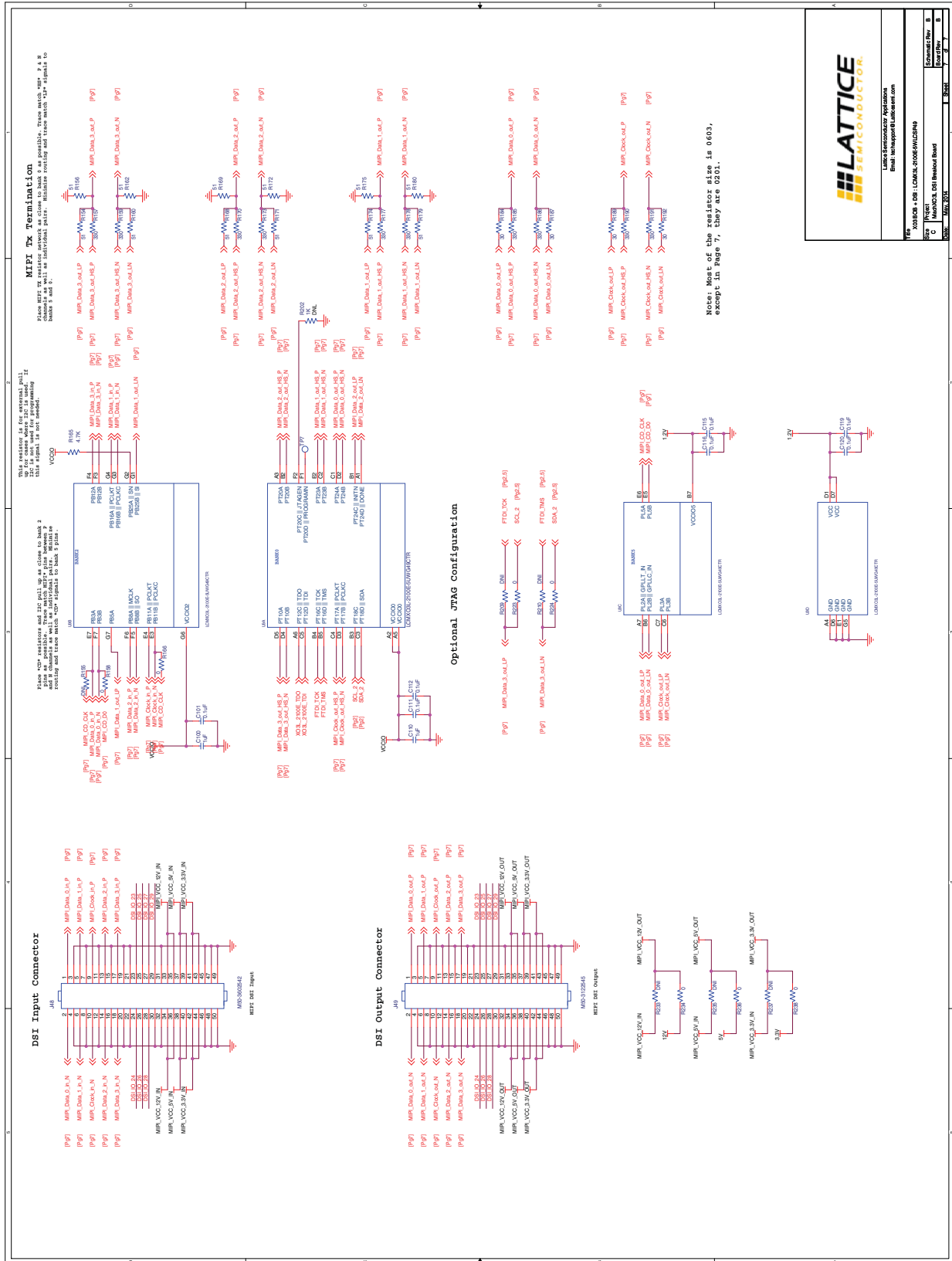
Lattice Semiconductor Corporation  
Email: techsupport@lattice.com

**BREAKOUT CONNECTION**

Project Name: G0 Breakout Board  
Rev: 1.0  
Date: 08/20/2015

Sheet No: 1  
Board Part: B  
Board Rev: B

Figure 23. X03 BOB + DSI: LCMX3L-2100E-5WLCSP49



Lattice Semiconductor Corporation  
Email: support@lattice.com

Part	X03BOB + DS: LCMX3L-2100E-5WLCSP49
Rev	Rev 1.0
Doc	DS11001

Note: Most of the resistor size is 0603, except in Page 7, they are 0201.





Компания «ЭлектроПласт» предлагает заключение долгосрочных отношений при поставках импортных электронных компонентов на взаимовыгодных условиях!

Наши преимущества:

- Оперативные поставки широкого спектра электронных компонентов отечественного и импортного производства напрямую от производителей и с крупнейших мировых складов;
- Поставка более 17-ти миллионов наименований электронных компонентов;
- Поставка сложных, дефицитных, либо снятых с производства позиций;
- Оперативные сроки поставки под заказ (от 5 рабочих дней);
- Экспресс доставка в любую точку России;
- Техническая поддержка проекта, помощь в подборе аналогов, поставка прототипов;
- Система менеджмента качества сертифицирована по Международному стандарту ISO 9001;
- Лицензия ФСБ на осуществление работ с использованием сведений, составляющих государственную тайну;
- Поставка специализированных компонентов (Xilinx, Altera, Analog Devices, Intersil, Interpoint, Microsemi, Aeroflex, Peregrine, Syfer, Eurofarad, Texas Instrument, Miteq, Cobham, E2V, MA-COM, Hittite, Mini-Circuits, General Dynamics и др.);

Помимо этого, одним из направлений компании «ЭлектроПласт» является направление «Источники питания». Мы предлагаем Вам помощь Конструкторского отдела:

- Подбор оптимального решения, техническое обоснование при выборе компонента;
- Подбор аналогов;
- Консультации по применению компонента;
- Поставка образцов и прототипов;
- Техническая поддержка проекта;
- Защита от снятия компонента с производства.



#### Как с нами связаться

**Телефон:** 8 (812) 309 58 32 (многоканальный)

**Факс:** 8 (812) 320-02-42

**Электронная почта:** [org@eplast1.ru](mailto:org@eplast1.ru)

**Адрес:** 198099, г. Санкт-Петербург, ул. Калинина, дом 2, корпус 4, литера А.