

## BC856-HF Thru. BC858-HF Series (PNP)

RoHS Device  
Halogen Free



### Features

- Ideally suited for automatic insertion
- Power dissipation  
PCM: 0.25W (@TA=25°C)
- Low current.(max. 100mA)
- Collector-base voltage  
VCBO: BC856 = -80V  
BC857 = -50V  
BC858 = -30V
- Operating and storage junction temperature range: TJ, TSTG= -65 to +150°C

### Mechanical data

- Case: SOT-23, molded plastic.
- Terminals: Solderable per MIL-STD-750, method 2026.

### Circuit diagram

- 1.BASE
- 2.EMITTER
- 3.COLLECTOR

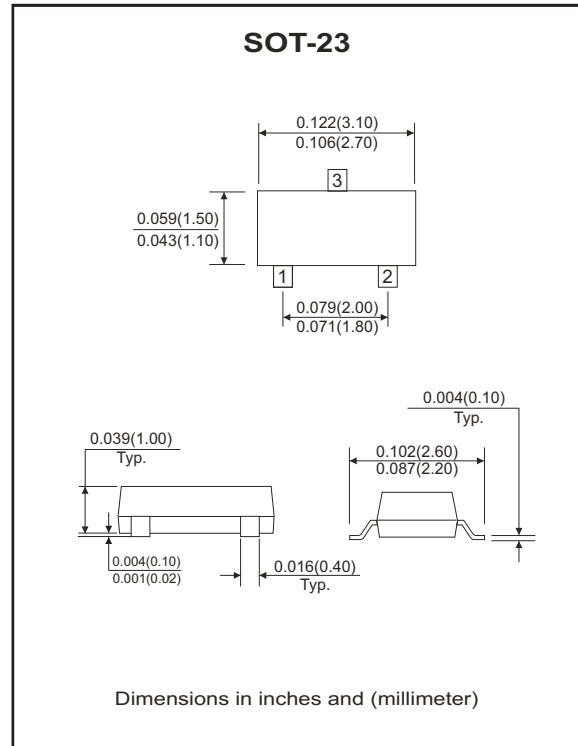
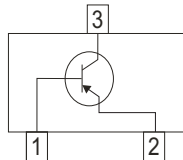

### Maximum Ratings (at Ta=25°C unless otherwise noted)

Parameter	Symbol	Value	Unit
Collector-Base voltage	BC856 BC857 BC858 VCBO	-80 -50 -30	V
Collector-Emitter voltage	BC856 BC857 BC858 VCEO	-65 -45 -30	V
Emitter-Base voltage	VEBO	-5	V
Collector current-continuous	Ic	-0.1	A
Collector dissipation	Pc	250	mW
Junction temperature range	TJ	-65 to +150	°C
Storage temperature range	TSTG	-65 to +150	°C

## Electrical Characteristics (T<sub>A</sub>= 25°C unless otherwise specified)

Parameter	Symbol	Test Conditions	MIN	TYP	MAX	Unit
Collector-Base breakdown voltage	BC856 BC857 BC858 V <sub>(BR)CBO</sub>	I <sub>C</sub> = -10μA , I <sub>E</sub> =0	-80 -50 -30			V
Collector-Emitter breakdown voltage	BC856 BC857 BC858 V <sub>(BR)CEO</sub>	I <sub>C</sub> = -10mA , I <sub>B</sub> =0	-65 -45 -30			V
Emitter-Base breakdown voltage	V <sub>(BR)EBO</sub>	I <sub>E</sub> = -1μA , I <sub>C</sub> =0	-5			V
Collector cut-off current	I <sub>CBO</sub>	V <sub>CB</sub> = -30V , I <sub>E</sub> =0		-1	-15	nA
Emitter cut-off current	I <sub>EBO</sub>	V <sub>EB</sub> = -5V , I <sub>C</sub> =0			-0.1	μA
DC current gain	BC856A ,857A ,858A BC856B ,857B ,858B BC857C ,858C h <sub>FE</sub>	V <sub>CE</sub> = -5V , I <sub>C</sub> = -2.2mA	125 220 420		250 475 800	
Collector-Emitter saturation voltage	V <sub>CE(sat)</sub>	I <sub>C</sub> = -100mA , I <sub>B</sub> =-5mA I <sub>C</sub> = -10mA , I <sub>B</sub> =-0.5mA			-0.65 -0.3	V
Base-Emitter saturation voltage	V <sub>BE(sat)</sub>	I <sub>C</sub> = -10mA , I <sub>B</sub> =-0.5mA I <sub>C</sub> = -100mA , I <sub>B</sub> =-5mA		-0.7 -0.85		V
Base-Emitter voltage	V <sub>BE(on)</sub>	I <sub>C</sub> = -2mA , V <sub>CE</sub> =-5V I <sub>C</sub> = -10mA , V <sub>CE</sub> =-5V	-0.6	-0.65	-0.75 -0.82	V
Collector capacitance	C <sub>C</sub>	V <sub>CB</sub> = -10V , I <sub>E</sub> =I <sub>e</sub> =0 f=1MHz		4.5		pF
Transition frequency	F	I <sub>C</sub> =-200uA, V <sub>CE</sub> =-5V R <sub>S</sub> =2kΩ, f=1kHz, B=200Hz		2	10	dB
Transition frequency	f <sub>T</sub>	V <sub>CE</sub> =-5V, I <sub>C</sub> =-10mA f=100MHz	100			MHz

## Electrical Characteristic Curves (BC856-HF Thru. BC858-HF Series)

Fig.1 - DC current gain as a function fo collector current; typical values.

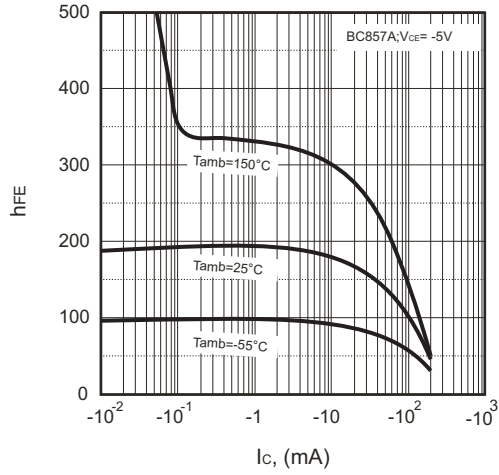

Fig.2 - Base-Emitter voltage as a function of collector current; typical values

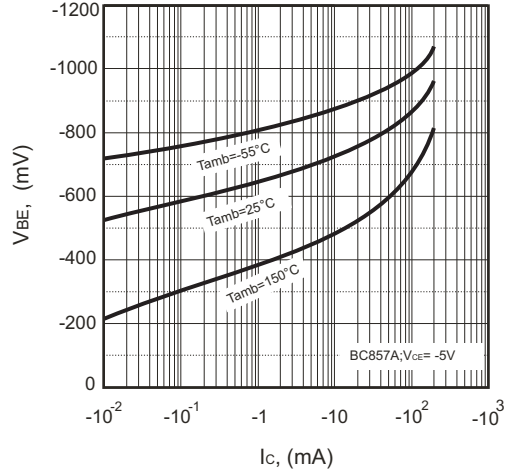

Fig.3 - Collector-Emitter saturation voltage as a function of collector current; typical values.

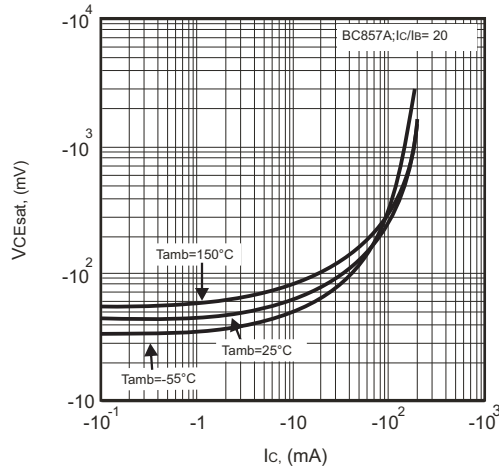

Fig.4 - Base-Emitter saturation voltage as a function of collector current; typical values

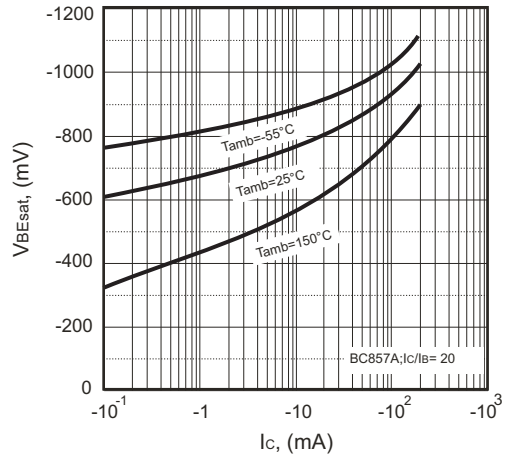

Fig.5 - DC current gain as a function fo collector current; typical values.

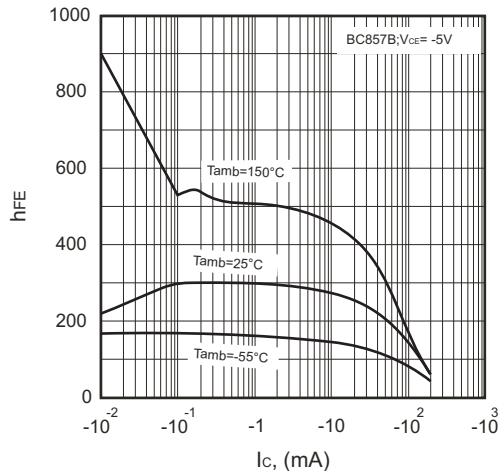
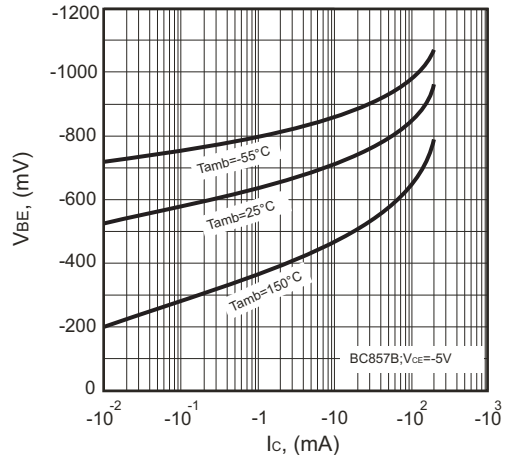

Fig. 6 - Base-Emitter voltage as a function of collector current; typical values.



## Electrical Characteristic Curves (BC856-HF Thru. BC858-HF Series)

Fig.7 - Collector-Emitter saturation voltage as a function of collector current typical values.

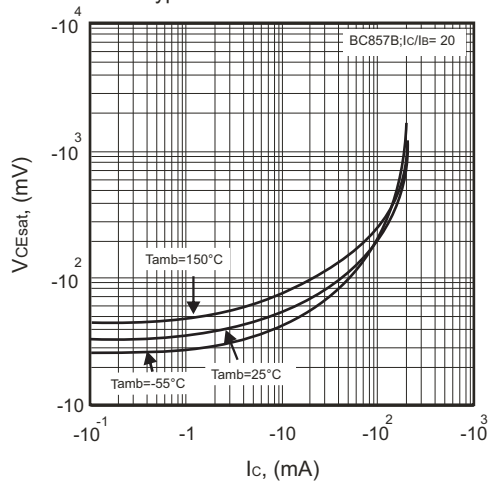

Fig.8 - Base-Emitter saturation voltage as a function of collector current; typical values

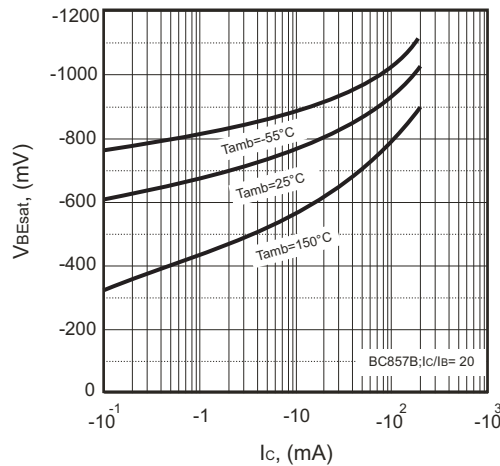

Fig.9 - DC current gain as a function fo collector current; typical values.

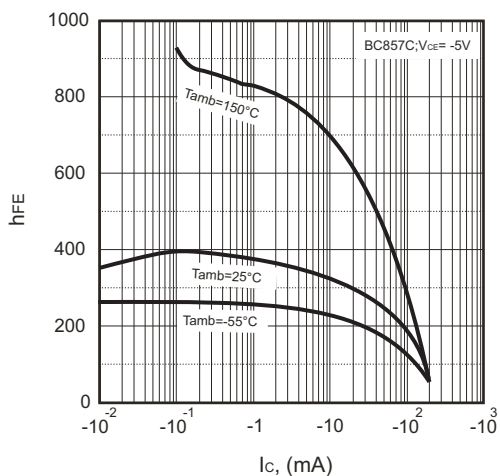

Fig.10 - Base-Emitter voltage as a function of collector current; typical values

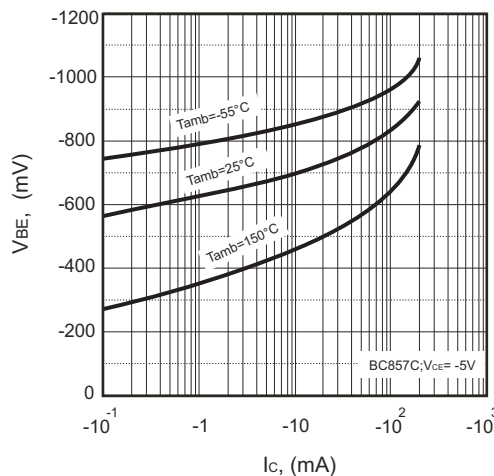

Fig.11 - Collector-Emitter saturation voltage as a function of collector current; typical values.

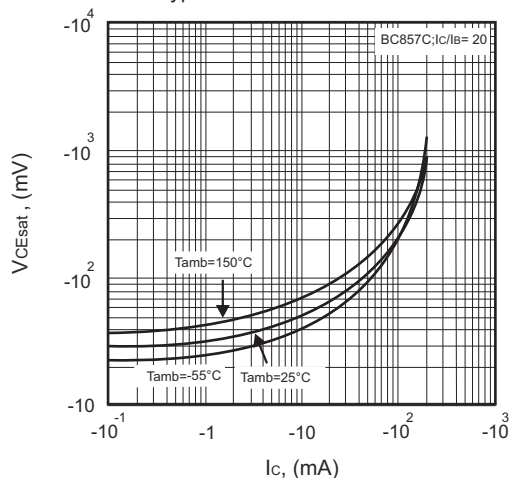
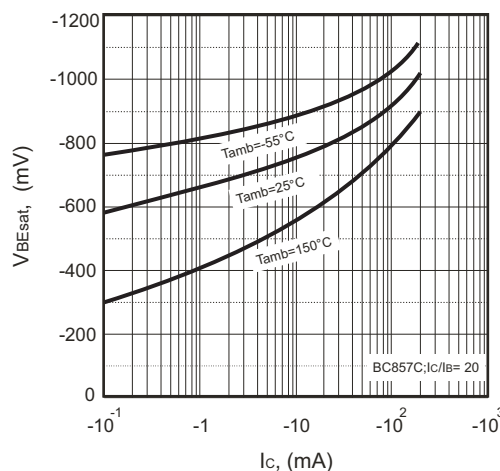
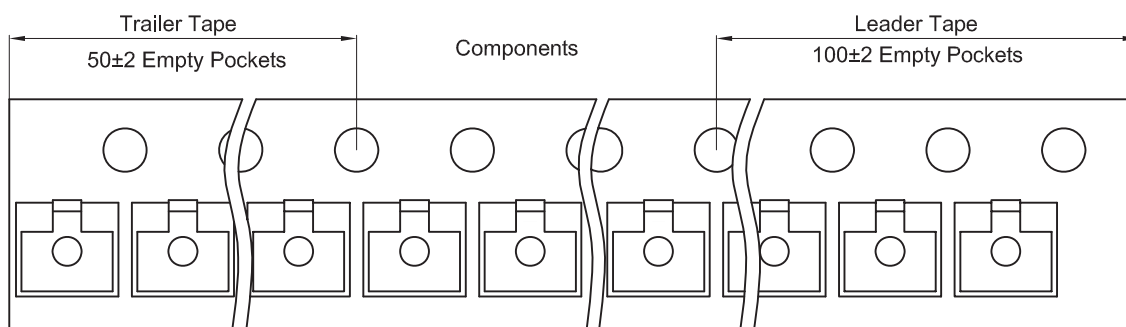
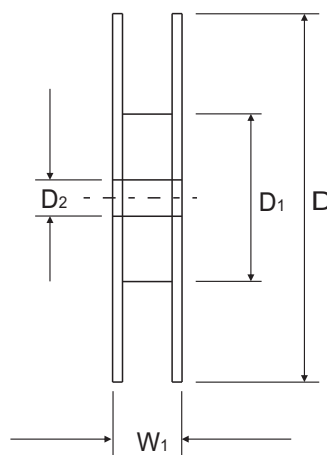
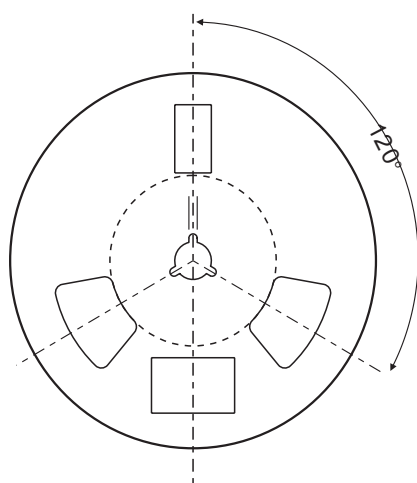
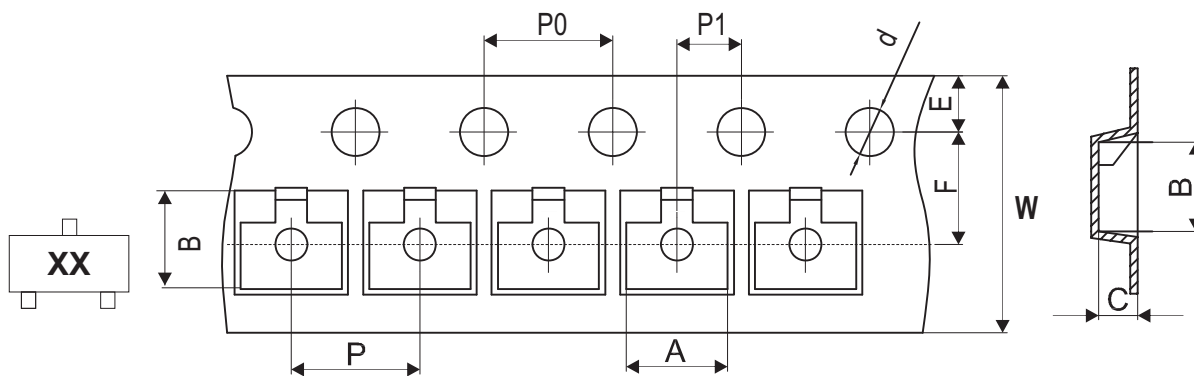

Fig.12 - Base-Emitter saturation voltage as a function of collector current; typical values



## Reel Taping Specification



SOT-23	SYMBOL	A	B	C	d	D	D1	D2
	(mm)	3.15 ± 0.10	2.77 ± 0.10	1.22 ± 0.10	1.50 ± 0.10	178.00 ± 1.00	54.40 ± 0.50	13.00 ± 0.50
	(inch)	0.124 ± 0.004	0.109 ± 0.004	0.048 ± 0.004	0.059 ± 0.004	7.008 ± 0.039	2.142 ± 0.020	0.512 ± 0.020

SOT-23	SYMBOL	E	F	P	P0	P1	W	W1
	(mm)	1.75 ± 0.10	3.50 ± 0.05	4.00 ± 0.10	4.00 ± 0.10	2.00 ± 0.05	8.00 + 0.30 / - 0.10	12.50 ± 1.00
	(inch)	0.069 ± 0.004	0.138 ± 0.002	0.157 ± 0.004	0.157 ± 0.004	0.079 ± 0.002	0.315 + 0.012 / - 0.004	0.492 ± 0.039

## Marking Code

Part Number	Marking Code
BC856A-HF	3A
BC857A-HF	3E
BC858A-HF	3J
BC856B-HF	3B
BC857B-HF	3F
BC858B-HF	3K
BC857C-HF	3G
BC858C-HF	3L

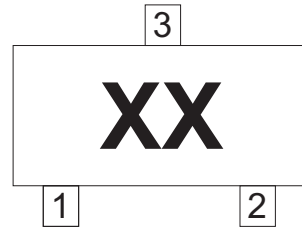

xx = Product type marking code

## Suggested PAD Layout

SIZE	SOT-23	
	(mm)	(inch)
A	0.90	0.035
B	0.80	0.031
C	1.90	0.075
D	2.00	0.079

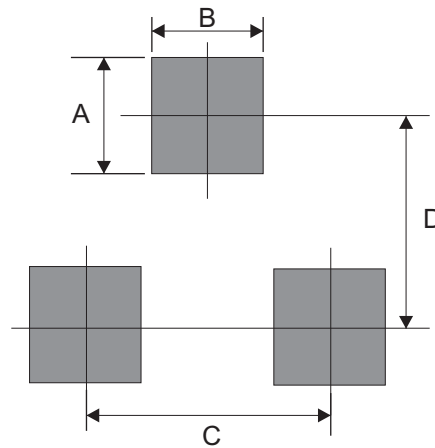

## Standard Packaging

Case Type	Qty Per Reel	Reel Size
	(Pcs)	(inch)
SOT-23	3,000	7



Компания «ЭлектроПласт» предлагает заключение долгосрочных отношений при поставках импортных электронных компонентов на взаимовыгодных условиях!

Наши преимущества:

- Оперативные поставки широкого спектра электронных компонентов отечественного и импортного производства напрямую от производителей и с крупнейших мировых складов;
- Поставка более 17-ти миллионов наименований электронных компонентов;
- Поставка сложных, дефицитных, либо снятых с производства позиций;
- Оперативные сроки поставки под заказ (от 5 рабочих дней);
- Экспресс доставка в любую точку России;
- Техническая поддержка проекта, помощь в подборе аналогов, поставка прототипов;
- Система менеджмента качества сертифицирована по Международному стандарту ISO 9001;
- Лицензия ФСБ на осуществление работ с использованием сведений, составляющих государственную тайну;
- Поставка специализированных компонентов (Xilinx, Altera, Analog Devices, Intersil, Interpoint, Microsemi, Aeroflex, Peregrine, Syfer, Eurofarad, Texas Instrument, Miteq, Cobham, E2V, MA-COM, Hittite, Mini-Circuits, General Dynamics и др.);

Помимо этого, одним из направлений компании «ЭлектроПласт» является направление «Источники питания». Мы предлагаем Вам помощь Конструкторского отдела:

- Подбор оптимального решения, техническое обоснование при выборе компонента;
- Подбор аналогов;
- Консультации по применению компонента;
- Поставка образцов и прототипов;
- Техническая поддержка проекта;
- Защита от снятия компонента с производства.



#### Как с нами связаться

**Телефон:** 8 (812) 309 58 32 (многоканальный)

**Факс:** 8 (812) 320-02-42

**Электронная почта:** [org@eplast1.ru](mailto:org@eplast1.ru)

**Адрес:** 198099, г. Санкт-Петербург, ул. Калинина, дом 2, корпус 4, литера А.