

FEATURES

Ultralow SSB phase noise: -150 dBc/Hz typical
Single-ended input/outputs
Output power: -2 dBm typical
Single supply operation: 3 V
Ultrasmall, surface-mount, 2.90 mm \times 2.80 mm, 6-lead SOT-23 package

APPLICATIONS

DC to C band PLL prescalers
Very small aperture terminal (VSAT) radios
Unlicensed national information infrastructure (UNII) and point to point radios
IEEE 802.11a and high performance radio local area network (HiperLAN) WLAN
Fiber optics
Cellular/3G infrastructure

GENERAL DESCRIPTION

The **HMC434** is a low noise, static, divide by 8 prescaler monolithic microwave integrated circuit (MMIC) utilizing indium gallium phosphide/gallium arsenide (InGaP/GaAs) heterojunction bipolar transistor (HBT) technology in an ultrasmall surface-mount 6-lead SOT-23 package.

The **HMC434** operates from near dc (square wave) or 200 MHz (sine wave) to 8 GHz input frequency with a single 3 V dc supply.

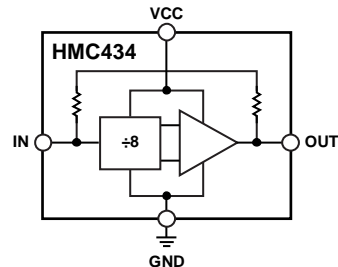
FUNCTIONAL BLOCK DIAGRAM*Figure 1.*

15684-001

The **HMC434** features single-ended inputs and outputs for reduced component count and cost. The low additive single sideband (SSB) phase noise of -150 dBc/Hz at 100 kHz offset helps the user maintain optimal system noise performance.

TABLE OF CONTENTS

Features	1
Applications.....	1
Functional Block Diagram	1
General Description	1
Revision History	2
Specifications.....	3
Absolute Maximum Ratings.....	4
Thermal Resistance	4
ESD Caution.....	4

REVISION HISTORY

4/2019—Rev. F to Rev. G

Change to Figure 11	6
Changes to Ordering Guide	9

8/2017—Rev. E to Rev. F

Added Endnote 2, Table 1.....	3
-------------------------------	---

Pin Configuration and Function Descriptions.....	5
Interface Schematics	5
Typical Performance Characteristics	6
Applications Information	7
Evaluation Board PCB	7
PCB Material Stackup.....	8
Outline Dimensions	9
Ordering Guide	9

This Hittite Microwave Products data sheet has been reformatted to meet the styles and standards of Analog Devices, Inc.

3/2017—Rev. 04.0410 to Rev. E

Updated Format.....	Universal
Changes to Features Section, Figure 1, and General Description Section.....	1
Changes to Table 1.....	3
Changes to Table 2.....	4
Added Thermal Resistance Section and Table 3; Renumbered Sequentially	4
Added Figure 2; Renumbered Sequentially	5
Changes to Table 4, Figure 4, Figure 5, and Figure 6.....	5
Changes to Figure 7, Figure 8, Figure 9, and Figure 10.....	6
Added Applications Information Section	7
Changes to Evaluation Board PCB Section, Table 5, and Figure 13, and Figure 14.....	7
Added PCB Material Stackup Section and Figure 15	8
Updated Outline Dimensions.....	9
Change to Ordering Guide.....	9

SPECIFICATIONS

$V_{CC} = 3\text{ V}$, $T_A = 25^\circ\text{C}$, $50\ \Omega$ system, unless otherwise noted. P_{IN} is input power.

Table 1.

Parameter	Min	Typ	Max	Unit	Test Conditions / Comments
RADIO FREQUENCY (RF) INPUT					
Frequency ^{1, 2}	0.2		8	GHz	Sine wave input
Power	-10	0	+10	dBm	$f_{IN} = 1.0\text{ GHz to }3.0\text{ GHz}$
	0	0	10	dBm	$f_{IN} = 3.0\text{ GHz to }8.0\text{ GHz}$
RF OUTPUT					
SSB Phase Noise		-150		dBc/Hz	100 kHz offset, $P_{IN} = 0\text{ dBm}$, $f_{IN} = 4.0\text{ GHz}$
Power	-5	-2		dBm	$f_{IN} = 1.0\text{ GHz to }8.0\text{ GHz}$
REVERSE LEAKAGE		-25		dBm	$P_{IN} = 0\text{ dBm}$, $f_{IN} = 4.0\text{ GHz}$, output terminated
SUPPLY					
Voltage (V_{CC})	2.85	3	3.15	V	
Current (I_{CC})		62	83	mA	

¹ Below 200 MHz, a square wave input is required.

² For stable operation without an input signal, refer to [AN-1463](#).

ABSOLUTE MAXIMUM RATINGS

Table 2.

Parameter	Rating
Supply Voltage (V_{CC})	-0.3 V to +3.5 V
RF Input Power ($V_{CC} = 3$ V)	13 dBm
Temperature	
Operating	-40°C to +85°C
Storage	-65°C to +125°C
Junction, T_J	135°C
Nominal ($T_A = 85^\circ\text{C}$)	99°C
Reflow	260°C
ESD Sensitivity	
Human Body Model (HBM)	Class 0

Stresses at or above those listed under Absolute Maximum Ratings may cause permanent damage to the product. This is a stress rating only; functional operation of the product at these or any other conditions above those indicated in the operational section of this specification is not implied. Operation beyond the maximum operating conditions for extended periods may affect product reliability.

THERMAL RESISTANCE

Thermal performance is directly linked to printed circuit board (PCB) design and operating environment. Careful attention to PCB thermal design is required.

θ_{JA} is the natural convection junction to ambient thermal resistance measured in a one cubic foot sealed enclosure. θ_{JC} is the junction to case thermal resistance.

Table 3. Thermal Resistance

Package Type	θ_{JA} ¹	θ_{JC} ²	Unit
RJ-6	359	70	°C/W

¹ Simulated values per JEDEC JESD51-12 standards.

² Junction to GND package pin.

ESD CAUTION



ESD (electrostatic discharge) sensitive device. Charged devices and circuit boards can discharge without detection. Although this product features patented or proprietary protection circuitry, damage may occur on devices subjected to high energy ESD. Therefore, proper ESD precautions should be taken to avoid performance degradation or loss of functionality.

PIN CONFIGURATION AND FUNCTION DESCRIPTIONS

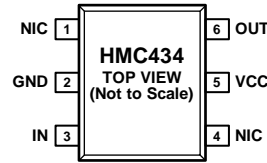

NOTES
1. NOT INTERNALLY CONNECTED. THESE PINS CAN BE CONNECTED TO RF AND DC GROUND WITHOUT AFFECTING PERFORMANCE. THE NIC PINS ARE TYPICALLY TIED TO GND FOR ENHANCED THERMAL PERFORMANCE (BUT NOT REQUIRED).

15684-002

Figure 2. Pin Configuration

Table 4. Pin Function Descriptions

Pin No.	Mnemonic	Description
1, 4	NIC	Not Internally Connected. These pins can be connected to RF and dc ground without affecting performance. The NIC pins are typically tied to GND for enhanced thermal performance (but not required).
2	GND	Ground. This pin must be connected to both RF and dc ground.
3	IN	RF Input. This pin must be dc blocked.
5	VCC	Supply Voltage (3 V).
6	OUT	RF Output. This pin must be dc blocked.

INTERFACE SCHEMATICS



Figure 3. GND Interface Schematic

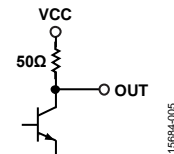

Figure 5. OUT Interface Schematic

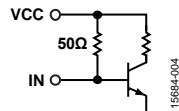

Figure 4. IN Interface Schematic

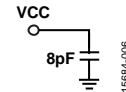

Figure 6. VCC Interface Schematic

TYPICAL PERFORMANCE CHARACTERISTICS

In Figure 9, $P_{FEEDTHROUGH}$ is the power of the output spectrum at the input frequency.

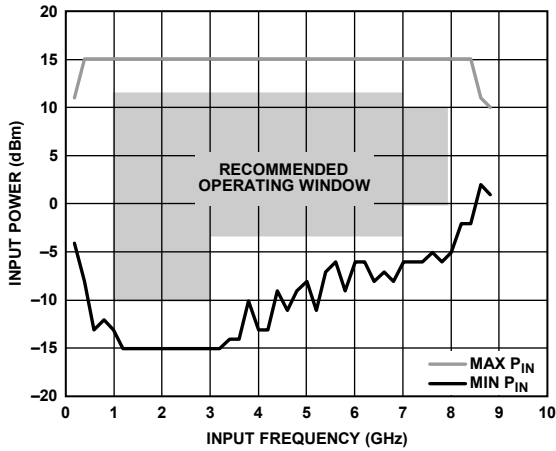

Figure 7. Input Sensitivity Window

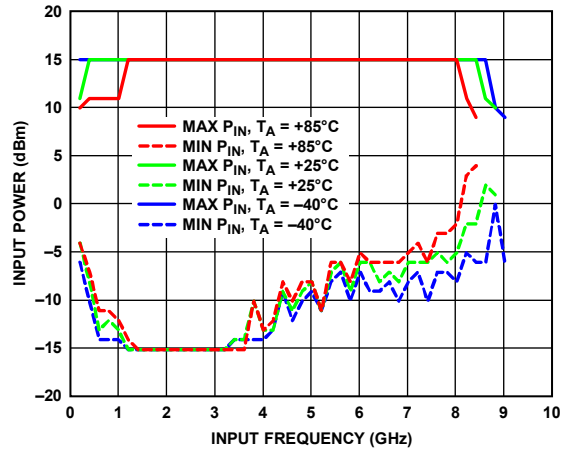

Figure 10. Input Sensitivity Window at Various Temperatures

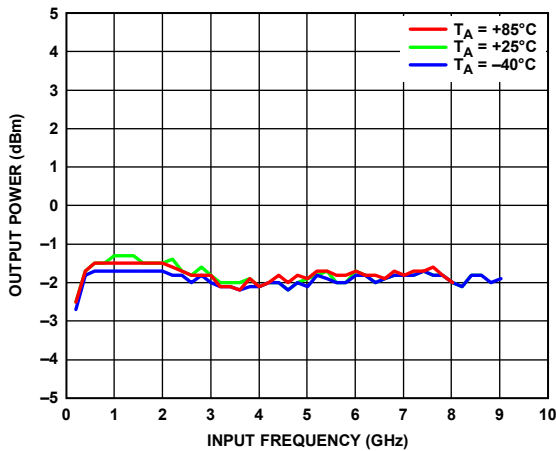

Figure 8. Output Power vs. Frequency at Various Temperatures

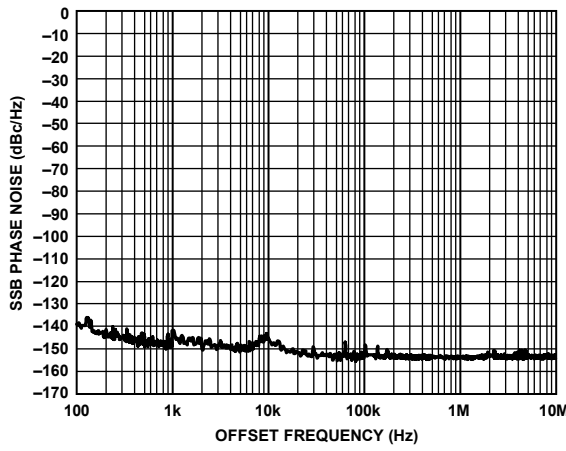

Figure 11. Residual SSB Phase Noise (Carrier Frequency = 320 MHz, $P_{IN} = 0$ dBm)

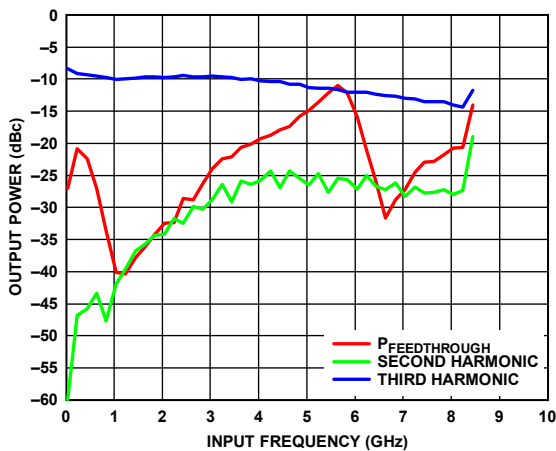

Figure 9. Output Harmonic Content ($P_{IN} = 0$ dBm)

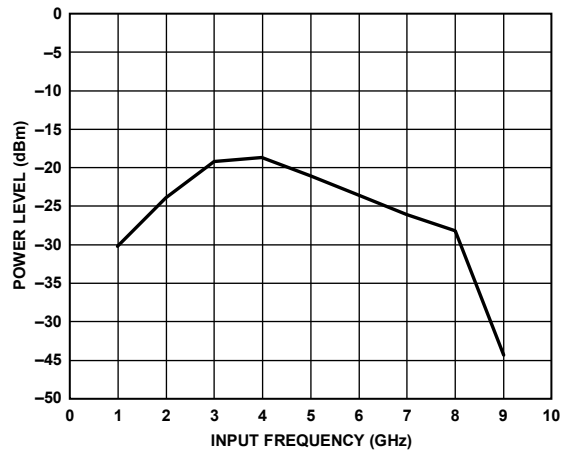

Figure 12. Reverse Leakage ($P_{IN} = 0$ dBm)

APPLICATIONS INFORMATION

EVALUATION BOARD PCB

Use RF circuit design techniques for the PCB used in the application. Ensure that signal lines have 50 Ω impedance when the package ground leads are connected directly to the ground plane (see Figure 14). Use a sufficient number of via holes to connect the top and bottom ground planes.

The evaluation board has two connectors, as shown in Figure 14. The RF input connector (J1) and the RF output connector (J2) are PCB mount SMA connectors.

The evaluation board is powered from a single 3 V supply; connect this supply using the J3 (VCC) and J4 (GND) test points.

See Figure 13 and Table 5 for the evaluation board schematic and the bill of materials, respectively.

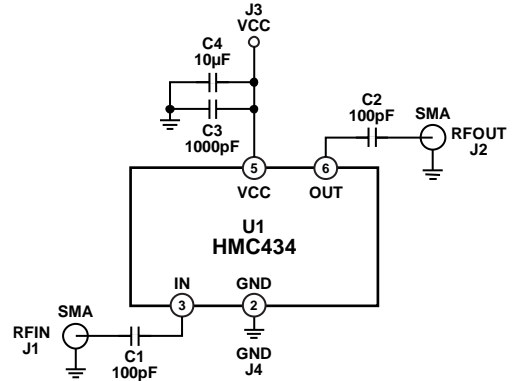

Figure 13. Evaluation Board Schematic

Table 5. List of Materials for Evaluation PCB 105675-HMC434¹

Item	Description
J1, J2	PCB mount SMA RF connectors
J3, J4	DC pins
C1, C2	100 pF capacitors, 0402 package
C3	1000 pF capacitors, 0402 package
C4	10 µF tantalum capacitors, 1206 package
U1	HMC434/HMC434E , divide by 8
PCB ²	105199 evaluation board

¹ 105199 is the raw bare PCB identifier. Reference [105675-HMC434](#) when ordering the complete evaluation PCB.

² Circuit board material: Arlon 25FR or Rogers RO4350B.

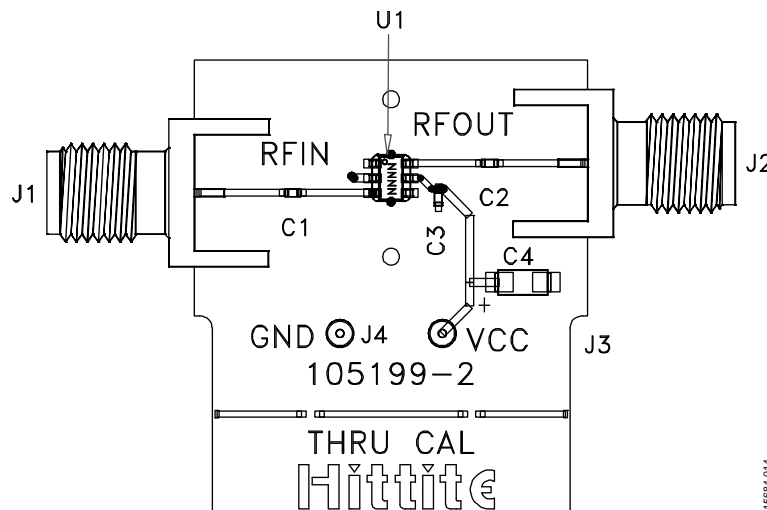

Figure 14. Evaluation Board—Top View

PCB MATERIAL STACKUP

The evaluation board is built using Arlon 25FR or Rogers RO4350B and standard FR4 materials. RF trace widths are designed to achieve a controlled 50 Ω characteristic impedance. The complete PCB stackup is shown in Figure 15.

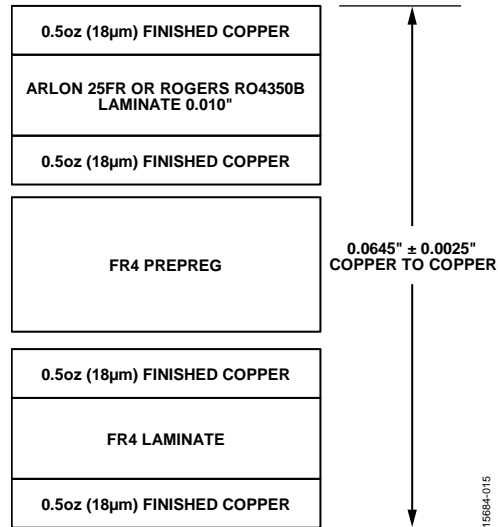
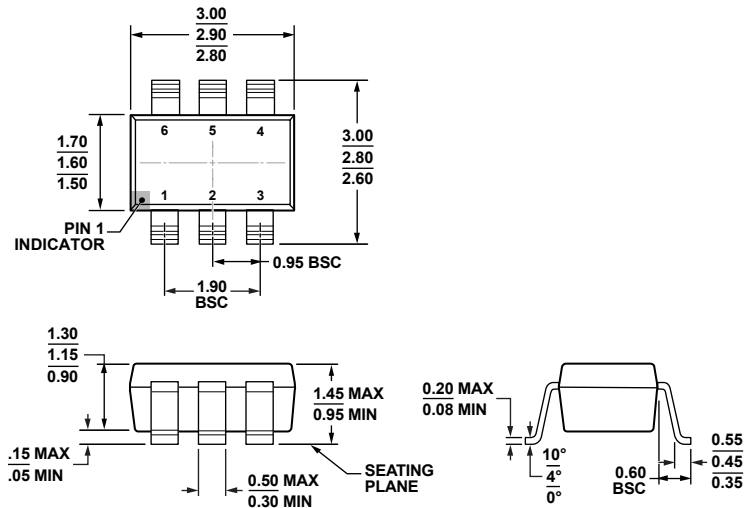

Figure 15. Evaluation Board PCB Stackup

OUTLINE DIMENSIONS



COMPLIANT TO JEDEC STANDARDS MO-178-AB

Figure 16. 6-Lead Small Outline Transistor Package [SOT-23] (RJ-6)

Dimensions shown in millimeters

12-16-2008-A

ORDERING GUIDE

Model ¹	Temperature Range	Package Description	Package Option
HMC434	-40°C to +85°C	6-Lead Small Outline Transistor Package [SOT-23]	RJ-6
HMC434TR	-40°C to +85°C	6-Lead Small Outline Transistor Package [SOT-23]	RJ-6
HMC434E	-40°C to +85°C	6-Lead Small Outline Transistor Package [SOT-23]	RJ-6
HMC434ETR	-40°C to +85°C	6-Lead Small Outline Transistor Package [SOT-23]	RJ-6
105675-HMC434		Evaluation Board	

¹ The HMC434E and HMC434ETR are RoHS compliant parts.



Компания «ЭлектроПласт» предлагает заключение долгосрочных отношений при поставках импортных электронных компонентов на взаимовыгодных условиях!

Наши преимущества:

- Оперативные поставки широкого спектра электронных компонентов отечественного и импортного производства напрямую от производителей и с крупнейших мировых складов;
- Поставка более 17-ти миллионов наименований электронных компонентов;
- Поставка сложных, дефицитных, либо снятых с производства позиций;
- Оперативные сроки поставки под заказ (от 5 рабочих дней);
- Экспресс доставка в любую точку России;
- Техническая поддержка проекта, помощь в подборе аналогов, поставка прототипов;
- Система менеджмента качества сертифицирована по Международному стандарту ISO 9001;
- Лицензия ФСБ на осуществление работ с использованием сведений, составляющих государственную тайну;
- Поставка специализированных компонентов (Xilinx, Altera, Analog Devices, Intersil, Interpoint, Microsemi, Aeroflex, Peregrine, Syfer, Eurofarad, Texas Instrument, Miteq, Cobham, E2V, MA-COM, Hittite, Mini-Circuits, General Dynamics и др.);

Помимо этого, одним из направлений компании «ЭлектроПласт» является направление «Источники питания». Мы предлагаем Вам помощь Конструкторского отдела:

- Подбор оптимального решения, техническое обоснование при выборе компонента;
- Подбор аналогов;
- Консультации по применению компонента;
- Поставка образцов и прототипов;
- Техническая поддержка проекта;
- Защита от снятия компонента с производства.



Как с нами связаться

Телефон: 8 (812) 309 58 32 (многоканальный)

Факс: 8 (812) 320-02-42

Электронная почта: org@eplast1.ru

Адрес: 198099, г. Санкт-Петербург, ул. Калинина, дом 2, корпус 4, литера А.