

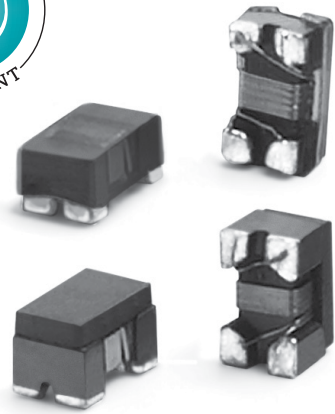





SMD CHIP CHOKES

Wire-Wound Series



-  Wire wound Ferrite 1210 (3225) core
-  Common Mode Noise suppression without attenuating the signal
-  Magnetically shielded for low Rdc and High Current
-  Perfect for USB2.0/3.0, IEEE1349 Fire wire and other LVDS lines
-  Ideal for DC voltage supply lines for Power over Ethernet -PoE/PoE+

PART NUMBER LEGEND

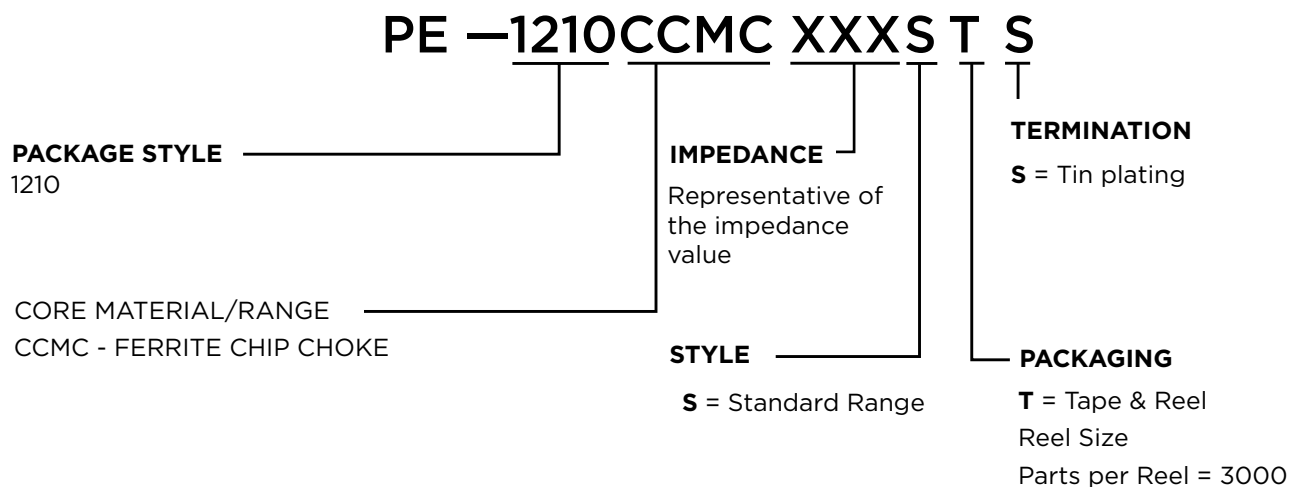

SPECIFICATION

Electrical Specifications @ 25°C

Part Number (25%)	Common Mode Impedance @ 100MHz (Ω)	DC Resistance (Ω MAX)	Rated Voltage (Vdc)	Rated Current (mA MAX)	Withstanding Voltage (Vdc)	Insulation Resistance (MΩ MIN)
PE-1210CCMC161STS	160	0.15	50	680	125	10
PE-1210CCMC271STS	270	0.25	50	640	125	10
PE-1210CCMC601STS	600	0.12	50	1000	125	10
PE-1210CCMC102STS	1000	0.35	50	480	125	10

Mechanical

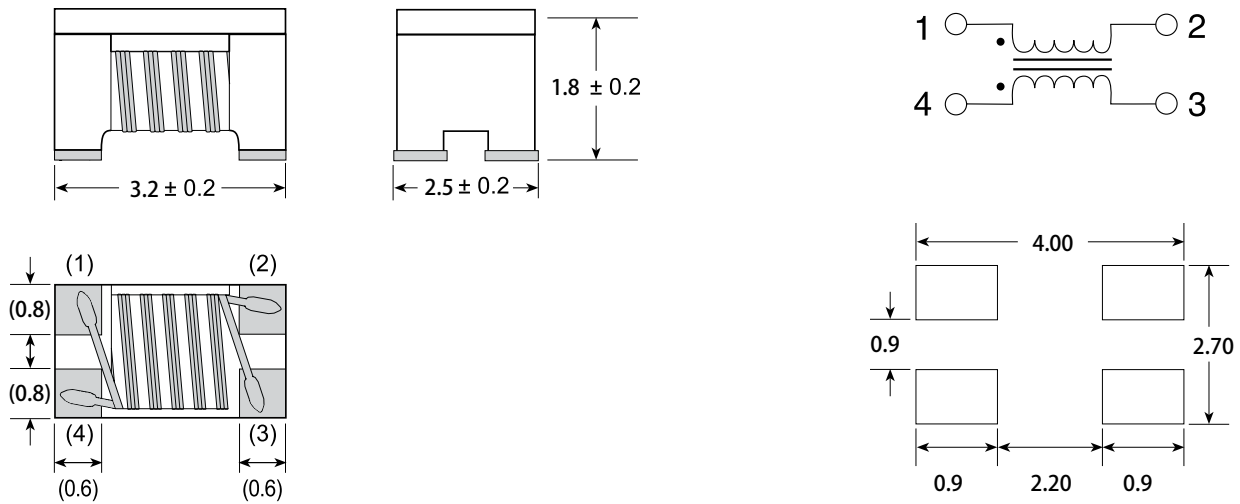

Impedance vs Frequency

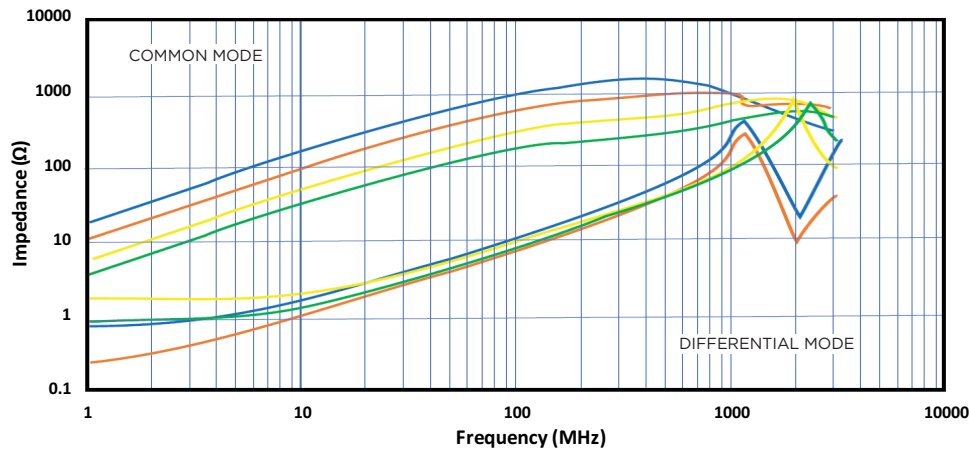

- PRODUCT KEY**
- PE-1210CCMC161STS —
 - PE-1210CCMC271STS —
 - PE-1210CCMC601STS —
 - PE-1210CCMC102STS —

PERFORMANCE TESTING

Electrical Testing		
Storage and Operating Temperature Range: -40° to +85°C	Inductors are subjected to the extremes for 48 hours. Then tested at 25°C	There shall be no deformation or change in appearance Inductance shall not change by more than ±5% Q values shall not change by more than ±10%
Thermal: -40° to +85°C	Inductors are subjected to 30 cycles for 30 minutes at each extreme. Then tested at 25°C	
Moisture Resistance	Inductors are subjected to 10 cycles of 24 hours at 70°C with 90 to 95% Relative Humidity Then tested at 25°C	
Operating Life	Inductors are subjected to 1000 hours at 85°C with 85% Relative Humidity with the rated current applied	

Mechanical Testing																														
Temperature Range:	Inductors are subjected to the following: Use a solder pot at 260C, with RMA Flux. Each termination is immersed in 63Sn/37Pb molten solder for 4 to 6 seconds.	There shall be no deformation or change in appearance Inductance shall not change by more than ±5% Q values shall not change by more than ±10%																												
Recommended Solder Heat Resistance Profile	<table border="1"> <caption>Recommended Solder Heat Resistance Profile Data</caption> <thead> <tr> <th>TIME (SECOND)</th> <th>TEMPERATURE (C°)</th> </tr> </thead> <tbody> <tr><td>0</td><td>25</td></tr> <tr><td>25</td><td>35</td></tr> <tr><td>50</td><td>45</td></tr> <tr><td>75</td><td>75</td></tr> <tr><td>100</td><td>150</td></tr> <tr><td>125</td><td>165</td></tr> <tr><td>150</td><td>175</td></tr> <tr><td>175</td><td>190</td></tr> <tr><td>200</td><td>225</td></tr> <tr><td>225</td><td>260</td></tr> <tr><td>250</td><td>225</td></tr> <tr><td>275</td><td>185</td></tr> <tr><td>300</td><td>150</td></tr> </tbody> </table>		TIME (SECOND)	TEMPERATURE (C°)	0	25	25	35	50	45	75	75	100	150	125	165	150	175	175	190	200	225	225	260	250	225	275	185	300	150
TIME (SECOND)	TEMPERATURE (C°)																													
0	25																													
25	35																													
50	45																													
75	75																													
100	150																													
125	165																													
150	175																													
175	190																													
200	225																													
225	260																													
250	225																													
275	185																													
300	150																													

TAPE AND REEL SPECIFICATIONS

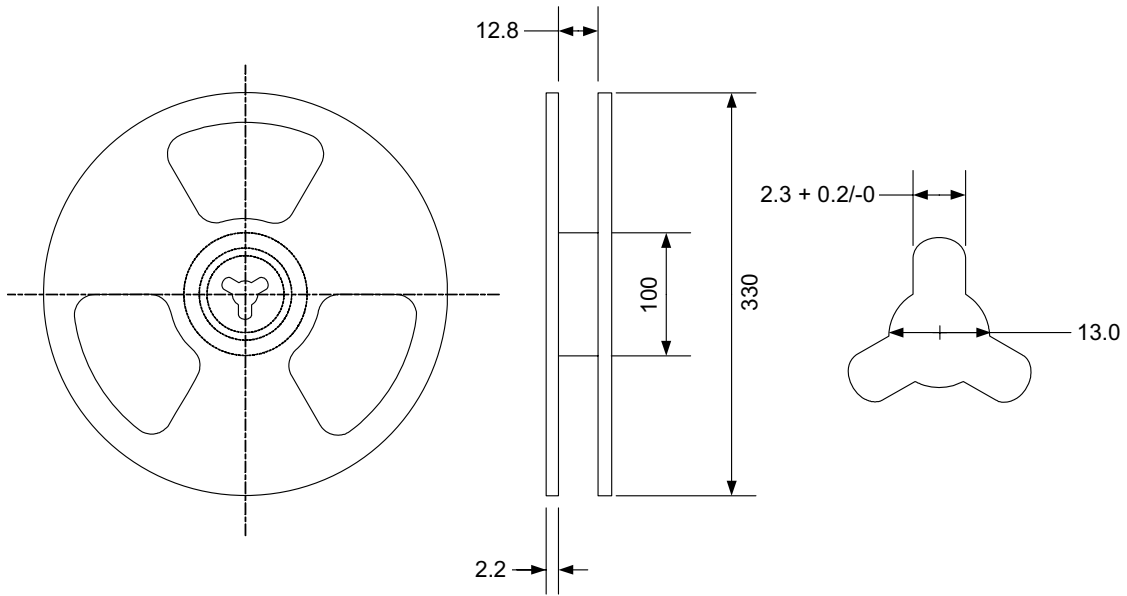

Series	Parts per Reel	Tape Dimensions (mm)					
		W	P1	P2	P3	H	T
1210CCMC	3000	12	2	8	4	2.3	0.3

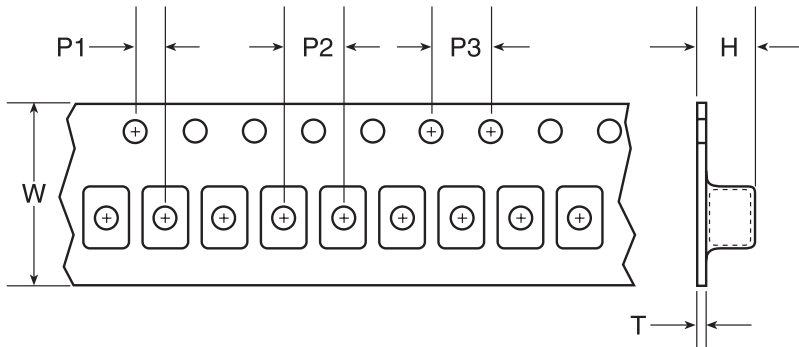

For More Information:

Americas - prodinfo@networkamericas@pulseelectronics.com | Europe - comms@pulseelectronics.com | Asia - prodinfo@networkapac@pulseelectronics.com

Performance warranty of products offered on this data sheet is limited to the parameters specified. Data is subject to change without notice. Other brand and product names mentioned herein may be trademarks or registered trademarks of their respective owners. © Copyright, 2019. Pulse Electronics, Inc. All rights reserved.



Компания «ЭлектроПласт» предлагает заключение долгосрочных отношений при поставках импортных электронных компонентов на взаимовыгодных условиях!

Наши преимущества:

- Оперативные поставки широкого спектра электронных компонентов отечественного и импортного производства напрямую от производителей и с крупнейших мировых складов;
- Поставка более 17-ти миллионов наименований электронных компонентов;
- Поставка сложных, дефицитных, либо снятых с производства позиций;
- Оперативные сроки поставки под заказ (от 5 рабочих дней);
- Экспресс доставка в любую точку России;
- Техническая поддержка проекта, помощь в подборе аналогов, поставка прототипов;
- Система менеджмента качества сертифицирована по Международному стандарту ISO 9001;
- Лицензия ФСБ на осуществление работ с использованием сведений, составляющих государственную тайну;
- Поставка специализированных компонентов (Xilinx, Altera, Analog Devices, Intersil, Interpoint, Microsemi, Aeroflex, Peregrine, Syfer, Eurofarad, Texas Instrument, Miteq, Cobham, E2V, MA-COM, Hittite, Mini-Circuits, General Dynamics и др.);

Помимо этого, одним из направлений компании «ЭлектроПласт» является направление «Источники питания». Мы предлагаем Вам помощь Конструкторского отдела:

- Подбор оптимального решения, техническое обоснование при выборе компонента;
- Подбор аналогов;
- Консультации по применению компонента;
- Поставка образцов и прототипов;
- Техническая поддержка проекта;
- Защита от снятия компонента с производства.



Как с нами связаться

Телефон: 8 (812) 309 58 32 (многоканальный)

Факс: 8 (812) 320-02-42

Электронная почта: org@eplast1.ru

Адрес: 198099, г. Санкт-Петербург, ул. Калинина, дом 2, корпус 4, литера А.