

3G3MX2 AC Drives

Born to drive machines



» Omron Quality with a capital "Q"

» High programming functionality

» Built-in safety

Harmonized motor and machine control

The 3G3MX2 is specifically designed to drive machines. It has been developed to harmonize advanced motor and machine control.

Thanks to its advanced design and algorithms the 3G3MX2 provides smooth control down to zero speed, plus precise operation for fast cyclic operations and torque control capability in open loop.

The 3G3MX2 also gives you comprehensive functionality for machine control such as positioning, speed synchronization and logic programming. The 3G3MX2 is fully integrated within the Omron smart automation platform. The 3G3MX2 is the child of a true leader in machine automation.

MOTOR CONTROL

200% starting torque

- Near stand-still operation (0.5 Hz)
- Smooth control of high inertia loads
- Control of fast cyclic loads

Torque control in open loop

- Ideal for low to medium torque applications
- Can replace a flux vector or servo drive in suitable systems

Special motors

- Permanent magnet motors
- High speed motors up to 1000 Hz

One parameter auto-tuning

- Just by entering the power rating of the motor the 3G3MX2 gives you smooth and safe operation





MACHINE CONTROL

Safety inside

- Conforms to safety norm ISO-13849-1 Cat 3 performance level D
- 2 Safety inputs
- External device monitoring (EDM)

Logic programming

- Flow chart programming
- Intuitive – up to 5 tasks in parallel

Positioning

- Up to 8 pre-set positions with “Homing”
- Speed synchronization

Integrated in the Omron Smart Automation

- CX-Drive programming tool connected via integrated USB port on 3G3MX2.
- Modbus RS485 built-in
- Option units for EtherCAT, Profibus, DeviceNet, ML-II, EtherNet/IP and more...

100% Control...

High starting torque and torque control capability in open loop mode gives you full control of your machine dynamics and performance. Options for all of the major fieldbus systems and a 24 VDC external supply keeps you in full control of your machine operation.



Torque master

The 3G3MX2 delivers 200% starting torque near stand-still (0.5 Hz) and can operate in torque control in open loop mode. This allows the 3G3MX2 to be used in applications where closed loop AC vector drives were previously used.



Easy network integration

Built-in RS485 Modbus communications and the possibility for integration in standard industrial networks, such as DeviceNet, Profibus, EtherNet/IP, CompoNet, ML-II or EtherCat makes the 3G3MX2 exceptionally easy to integrate.



External 24 VDC for continuous operation

With no additional hardware, a 24 VDC connection to the 3G3MX2 ensures the CPU is always in control, even if the main input is removed. This feature is vital in providing a controlled stop in emergency situations and in keeping the network communications operating.

...0% risk!

Safety is embedded in the 3G3MX2, according to ISO 13849-1, Cat 3, with two safety inputs and an External Device Monitoring (EDM) output. No external contactors on the motor side are required, meaning simpler wiring for the user.



Safety embedded; ISO 13849-1, Cat 3

Dual contactors at the output of the Drive are no longer required. Direct connection to a safety controller ensures compliance to ISO 13849-1, Cat 3.



EDM monitoring output

An External Device Monitoring (EDM) output confirms the safety status of the Drive, saving you the cost and wiring of external devices to carry out the same function.



Direct integration into the safety circuit

3G3MX2 Drives can fit easily into the safety circuit. The safety inputs can be linked from one drive to another without additional safety relays.

Position and run!

The 3G3MX2 is a drive and position controller in one, ideal for modular machines where moderate positional accuracy is required. Speed synchronization is also possible, with no additional programming required.



Speed synchronization

With no external hardware required, and via standard parameter settings, speed synchronization can be achieved. The 3G3MX2 will act as a speed follower to an external pulse generator/ encoder signal up to 32 kHz.



Positioning functionality

Specially developed application functionality enables the 3G3MX2 to solve simple positioning tasks without the need for an external controller. Up to 8 positions, plus home, can be selected by the user, and furthermore, the 3G3MX2 can be switched between speed and position mode.

Program and play!

The 3G3MX2 gives you the power to create smart solutions using PLC functionality, as standard. Via an intuitive flow chart programming tool, you can create programs with up to 1000 lines of code and with 5 tasks running in parallel.

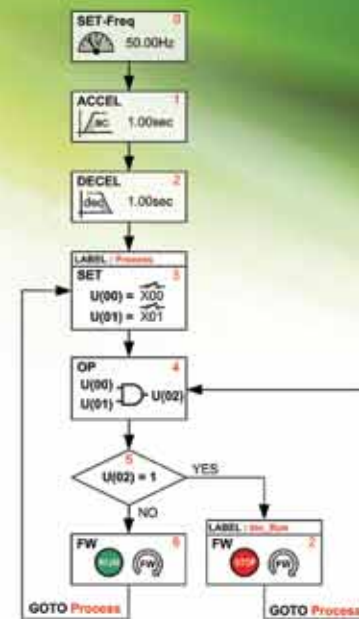

Free to program

- Intuitive and user friendly flow chart programming
- Integrated in CX-Drive
- Up to 1000 lines in a program
- 5 tasks can run in parallel

3G3MX2

Born to drive machines

- Current vector control
- High starting torque: 200% at 0.5Hz
- Double rating VT 120% for 1min and CT 150% for 1min
- Speed range up to 1000 Hz
- Induction motor & permanent magnet motor control
- Torque control in open loop vector
- Positioning functionality
- Built-in application functionality (i.e., Brake control)
- User programmable as standard
- Safety embedded compliant with ISO13849-1 (double input circuit and external device monitor EDM)
- USB port for PC programming
- 24 VDC backup supply for control board
- Fieldbus communications: Modbus, EtherNet/IP, DeviceNet, Profibus, Comconet, EtherCAT, and ML-II
- PC configuration tool: CX-Drive
- RoHS, CE, cULus

Ratings

- 200 V Class single-phase 0.1 to 2.2 kW (1/8 to 3 HP)
- 200 V Class three-phase 0.1 to 15.0 kW (1/8 to 20 HP)
- 400 V Class three-phase 0.4 to 15.0 kW (1/2 to 20 HP)



System Configuration



Specifications

Type Designation

3 G 3 M X 2 A B 0 0 1

3G3MX2 series

A: Standard specs

Voltage:
B: Single-phase 200 VAC
2: Three-phase 200 VAC
4: Three-phase 400 VAC

Max. applicable motor output
001: 0.1 kW (1/8 HP)
to
150: 15.0 kW (20 HP)

200 V class

Single-phase 3G3MX2-□			AB001	AB002	AB004	AB007 ¹	AB015	AB022	-	-	-	-	-	
Three-phase 3G3MX2-□			A2001	A2002	A2004	A2007	A2015	A2022	A2037	A2055	A2075	A2110	A2150	
Applicable motor capacity ²	kW	CT	0.1	0.2	0.4	0.75	1.5	2.2	3.7	5.5	7.5	11.0	15.0	
		VT	0.2	0.4	0.55	1.1	2.2	3.0	5.5	7.5	11.0	15.0	18.5	
	HP	CT	1/8	1/4	1/2	1.0	2.0	3.0	5.0	7 1/2	10.0	15.0	20.0	
		VT	1/4	1/2	3/4	1 1/2	3.0	4.0	7 1/2	10.0	15.0	20.0	25.0	
Output characteristics	Drive capacity kVA	200 VT	0.4	0.6	1.2	2.0	3.3	4.1	6.7	10.3	13.8	19.3	23.9	
		200 CT	0.2	0.5	1.0	1.7	2.7	3.8	6.0	8.6	11.4	16.2	20.7	
		240 VT	0.4	0.7	1.4	2.4	3.9	4.9	8.1	12.4	16.6	23.2	28.6	
		240 CT	0.3	0.6	1.2	2.0	3.3	4.5	7.2	10.3	13.7	19.5	24.9	
	Rated output current (A) at VT		1.2	1.9	3.5	6.0	9.6	12.0	19.6	30.0	40.0	56.0	69.0	
	Rated output current (A) at CT		1.0	1.6	3.0	5.0	8.0	11.0	17.5	25.0	33.0	47.0	60.0	
	Max. output voltage		Proportional to input voltage: 0 to 240 V											
Max. output frequency		1000 Hz												
Power supply	Rated input voltage and frequency		Single-phase 200 to 240 V 50/60 Hz 3-phase 200 to 240 V 50/60 Hz											
	Allowable voltage fluctuation		-15% to +10%											
	Allowable frequency fluctuation		5%											
Braking torque	At short-time deceleration At capacitor feedback		100%: <50Hz 50%: <60Hz				70%: <50Hz 50%: <60Hz		Approx. 20%		-			
	Cooling method		Self cooling					Forced-air-cooling						

Note: 1. Three phase model use forced-air-cooling but single phase model is self cooling.
2. Based on a standard 3-Phase standard motor.
3. Above 400Hz with some function limitation.

400 V class

Three-phase 3G3MX2-□			A4004	A4007	A4015	A4022	A4030	A4040	A4055	A4075	A4110	A4150		
Applicable motor capacity ¹	kW	CT	0.4	0.75	1.5	2.2	3.0	4.0	5.5	7.5	11.0	15.0		
		VT	0.75	1.5	2.2	3.0	4.0	5.5	7.5	11.0	15.0	18.5		
	HP	CT	1/2	1.0	2.0	3.0	4.0	5.0	7 1/2	10.0	15.0	20.0		
		VT	1.0	2.0	3.0	4.0	5.0	7 1/2	10.0	15.0	20.0	25.0		
Output characteristics	Drive capacity kVA	380 VT	1.3	2.6	3.5	4.5	5.7	7.3	11.5	15.1	20.4	25.0		
		380 CT	1.1	2.2	3.1	3.6	4.7	6.0	9.7	11.8	15.7	20.4		
		480 VT	1.7	3.4	4.4	5.7	7.3	9.2	14.5	19.1	25.7	31.5		
		480 CT	1.4	2.8	3.9	4.5	5.9	7.6	12.3	14.9	19.9	25.7		
	Rated output current (A) at VT		2.1	4.1	5.4	6.9	8.8	11.1	17.5	23.0	31.0	38.0		
	Rated output current (A) at CT		1.8	3.4	4.8	5.5	7.2	9.2	14.8	18.0	24.0	31.0		
Max. output voltage		Proportional to input voltage: 0 to 480 V												
Max. output frequency		1000 Hz												
Power supply	Rated input voltage and frequency		3-phase 380 to 480 V 50/60 Hz											
	Allowable voltage fluctuation		-15% to +10%											
	Allowable frequency fluctuation		5%											
Braking torque	At short-time deceleration At capacitor feedback		100%: <50Hz 50%: <60Hz				70%: <50Hz 50%: <60Hz		-		-			
	Cooling method		Self cooling				Forced-air-cooling							

Note: 1. Based on a standard 3-Phase standard motor.
2. Above 400Hz with some function limitation.

Specifications

Common specifications

Model number 3G3MX2-□		Specifications	
Control functions	Control methods	Phase-to-phase sinusoidal pulse with modulation PWM (Sensorless vector control, V/Hz)	
	Output frequency range	0.10 to 1000.00 Hz (with restrictions above 400Hz)	
	Frequency precision	Digital set value: ±0.01% of the max. frequency	
		Analog set value: ±0.2% of the max. frequency (25 ±10°C)	
	Resolution of frequency set value	Digital set value: 0.01 Hz	
		Analog set value: 1/1000 of maximum frequency	
	Resolution of output frequency	0.01 Hz	
	Starting torque	200% at 0.5 Hz	
	Overload capability	Dual rating: Heavy duty (CT): 150% for 1 minute Normal Duty (VT): 120% for 1 minute	
Frequency set value	0 to 10 VDC (10KΩ), 4 to 20mA (100Ω), RS485 Modbus, Network options		
V/Hz Characteristics	Constant/ reduced torque, free V/Hz		
Functionality	Inputs signals	FW (forward run command), RV (reverse run command), CF1~CF4 (multi-stage speed setting), JG (jog command), DB (external braking), SET (set second motor), 2CH (2-stage accel./decel. command), FRS (free run stop command), EXT (external trip), USP (startup function), CS (commercial power switchover), SFT (soft lock), AT (analog input selection), RS (reset), PTC (thermistor thermal protection), STA (start), STP (stop), F/R (forward/reverse), PID (PID disable), PIDC (PID reset), UP (remote control up function), DWN (remote control down function), UDC (remote control data clear), OPE (operator control), SF1~SF7 (multi-stage speed setting; bit operation), OLR (overload restriction), TL (torque limit enable), TRQ1 (torque limit changeover1), TRQ2 (torque limit changeover2), BOK (Braking confirmation), LAC (LAD cancellation), PCLR (position deviation clear), ADD (add frequency enable), F-TM (force terminal mode), ATR (permission of torque command input), KHC (Cumulative power clear), MI1~MI7 (general purpose inputs for EzSQ), AHD (analog command hold), CP1~CP3 (multistageposition switches), ORL (limit signal of zero-return), ORC (trigger signal of zero-return), SPD (speed/position changeover), GS1~GS2 (STO inputs, safety related signals), 485 (Starting communication signal), PRG (executing EzSQ program), HLD (retain output frequency), ROK (permission of run command), EB (rotation direction detection of B-phase), DISP (display limitation), OP (option control signal), NO (no function)	
	Output signals	RUN (run signal), FA1~FA5 (frequency arrival signal), OL,OL2 (overload advance notice signal), OD (PID deviation error signal), AL (alarm signal), OTQ (over/under torque threshold), UV (under-voltage), TRQ (torque limit signal), RNT (run time expired), ONT (power ON time expired), THM (thermal warning), BRK (brake release), BER (brake error), ZS (0Hz detection), DSE (speed deviation excessive), POK (positioning completion), ODc (analog voltage input disconnection), OIdc (analog current input disconnection), FBV (PID second stage output), NDc (network disconnect detection), LOG1~LOG3 (Logic output signals), WAC (capacitor life warning), WAF (cooling fan warning), FR (starting contact), OHF (heat sink overheat warning), LOC (Low load), MO1~MO3 (general outputs for EzSQ), IRDY (drive ready), FWR (forward operation), RVR (reverse operation), MJA (major failure), WCO (window comparator O), WCOI (window comparator Ol), FREF (frequency command source), REF (run command source), SETM (second motor in operation), EDM (STO (safe torque off) performance monitor), OP (option control signal), NO (no function)	
	Standard functions	Free-V/Hz, manual/automatic torque boost, output voltage gain adjustment, AVR function, reduced voltage start, motor data selection, auto-tuning, motor stabilization control, reverse running protection, simple position control, simple torque control, torque limiting, automatic carrier frequency reduction, energy saving operation, PID function, non-stop operation at instantaneous power failure, brake control, DC injection braking, dynamic braking (BRD), frequency upper and lower limiters, jump frequencies, curve accel and decel (S, U, inversed U,EL-S), 16-stage speed profile, fine adjustment of start frequency, accel and decel stop, process jogging, frequency calculation, frequency addition, 2-stage accel/decel, stop mode selection, start/end freq., analog input filter, window comparators, input terminal response time, output signal delay/hold function, rotation direction restriction, stop key selection, software lock, safe stop function, scaling function, display restriction, password function, user parameter, initialization, initial display selection, cooling fan control, warning, trip retry, frequency pull-in restart, frequency matching, overload restriction, over current restriction, DC bus voltage AVR	
	Analog inputs	2 analog inputs 0 to 10 V (10 KΩ), 4 to 20mA (100 Ω)	
	Pulse train input terminal	0 to 10 V (up to 24 V), up to 32 KHz	
	Accel/Decel times	0.01 to 3600.0 s (line/curve selection), 2nd accel/decel setting available	
	Display	Status indicator LED's Run, Program, Power, Alarm, Hz, Amps	
		Digital operator: Available to monitor 32 items: frequency reference, output current, output frequency...	
	Protection functions	Motor overload protection	Electronic Thermal overload relay and PTC thermistor input
		Instantaneous overcurrent	200% of rated current
Overload		Dual rating: Heavy duty (CT): 150% for 1 minute Normal Duty (VT): 120% for 1 minute	
Overvoltage		800 V for 400 V type and 400 V for 200 V type	
Undervoltage		345 V for 400 V type and 172.5 V for 200 V type	
Momentary power loss		Following items are selectable: Alarm, decelerates to stop, decelerates to stop with DC bus controlled, restart	
Cooling fin overheat		Temperature monitor and error detection	
Stall prevention level		Stall prevention during acceleration/deceleration and constant speed	
Ambient conditions	Ground fault	Detection at power-on	
	Power charge indication	On when power is supplied to the control part	
	Degree of protection	IP20, Varnish coating on PCB	
	Ambient humidity	90% RH or less (without condensation)	
	Storage temperature	-20 °C to +65 °C (short-term temperature during transportation)	
	Ambient temperature	-10°C to 40°C	
	Installation	Indoor (no corrosive gas, dust, etc.)	
Installation height	Max. 1000 m		
Vibration	5.9 m/s ² (0.6G), 10 to 55 Hz		

3G3MX2 AC Drives



Voltage class	Drive model	Figure	Dimensions (Unit: mm)									Weight (kg)
			W	W1	H	H1	t	D	D1	D2	d	
Single-phase 200 V	3G3MX2-AB001	1	68	56	128	118	-	109	13.5	-	-	1.0
	3G3MX2-AB002	1						123	27	-	-	1.0
	3G3MX2-AB004	1						170.5	55	4.4	4.5	1.1
	3G3MX2-AB007	2	108	96	128	118	-	170.5	55	4.4	4.5	1.4
	3G3MX2-AB015	2										1.8
	3G3MX2-AB022	2										1.8
Three-phase 200 V	3G3MX2-A2001	1	68	56	128	118	-	109	13.5	-	-	1.0
	3G3MX2-A2002	1						1134	27	-	-	1.0
	3G3MX2-A2004	1						146	50	-	-	1.1
	3G3MX2-A2007	1	108	96	128	118	-	170.5	55	4.4	4.5	1.2
	3G3MX2-A2015	2										1.6
	3G3MX2-A2022	2										1.8
	3G3MX2-A2037	3	140	128	128	118	5	170.5	55	4.4	4.5	2.0
	3G3MX2-A2055	3	140	122	260	248	6	155	73.3	6	6	3.0
	3G3MX2-A2075	3										3.4
	3G3MX2-A2110	3										180
3G3MX2-A2150	3	220	192	350	336	7	175	84	5	7	7.4	
Three-phase 400 V	3G3MX2-A4004	2	108	96	128	118	-	144	28	-	-	1.5
	3G3MX2-A4007	2						171	55	-	-	1.6
	3G3MX2-A4015	2						171	55	-	-	1.8
	3G3MX2-A4022	2	140	122	260	248	6	155	73.3	6	6	1.9
	3G3MX2-A4030	2										1.9
	3G3MX2-A4040	3										128
	3G3MX2-A4055	3	180	160	296	284	7	175	97	5	7	3.5
	3G3MX2-A4075	3										3.5
	3G3MX2-A4110	3										4.7
	3G3MX2-A4150	3	180	160	296	284	7	175	97	5	7	5.2

RFI Filters, Footprint Type

Voltage	Drive Model 3G3MX2-□	RFI Filter Model	RFI Filter Rated Current (A)	Dimensions (Unit: mm)						
				W	H	L	X	Y	M	
1-phase 200 VAC	AB001/AB002/AB004	3G3AX-FIM1010-RE	10	71	45	169	156	51	M4	
	AB007	3G3AX-FIM1014-RE	14	111	50	169	156	91	M4	
	AB015/AB022	3G3AX-FIM1024-RE	24	111	50	169	156	91	M4	
3-phase 200 VAC	A2001/A2002/A2004/A2007	3G3AX-FIM2010-RE	10	82	50	194	181	62	M4	
	A2015/A2022	3G3AX-FIM2020-RE	20	111	50	169	156	91	M4	
	A2037	3G3AX-FIM2030-RE	30	144	50	174	161	120	M4	
	A2055/A2075	3G3AX-FIM2060-RE	60	150	52	320	290	122	M5	
	A2110	3G3AX-FIM2080-RE	80	188	62	362	330	160	M5	
	A2150	3G3AX-FIM2100-RE	100	220	62	415	380	192	M6	
3-phase 400 VAC	A4004/A4007	3G3AX-FIM3005-RE	5	111	45	169	156	91	M4	
	A4015/A4022/A4030	3G3AX-FIM3010-RE	10	111	45	169	156	91	M4	
	A4040	3G3AX-FIM3014-RE	14	144	50	174	161	120	M4	
	A4055/A4075	3G3AX-FIM3030-RE	23	150	52	306	290	122	M5	
	A4110/A4150	3G3AX-FIM3050-RE	50	182	62	357	330	160	M5	



Accessories

Input AC Reactor

Voltage class	Model 3G3AX-□	Dimensions (Unit: mm)						Weight (kg)
		A	B2	C2	D	E	F	
200 V	RAI02800080-DE	120	70	120	80	52	5.5	1.78
	RAI00880200-DE	120	80	120	80	62	5.5	2.35
	RAI00350335-DE	180	85	190	140	55	6	5.5
	RAI00180670-DE	180	85	190	140	55	6	5.5
400 V	RAI07700050-DE	120	70	120	80	52	5.5	1.78
	RAI03500100-DE	120	80	120	80	62	5.5	2.35
	RAI01300170-DE	120	80	120	80	62	5.5	2.50
	RAI00740335-DE	180	85	190	140	55	6	5.5



DC Reactor

Voltage class	Model 3G3AX-□	Dimensions (Unit: mm)								Weight (kg)			
		A	B	C	D	E	F	G	H				
200 V	RC21400016-DE	84	113	96	101	66	5	7.5	2	1.22			
	RC10700032-DE			105						9.5	1.60		
	RC06750061-DE										116	9.5	1.95
	RC03510093-DE												3.20
	RC02510138-DE	108	135	124	120	82	6.5	9.5	9.5	3.20			
	RC01600223-DE	120	152	136	135	94	7	7	-	5.20			
	RC01110309-DE			146						6.00			
	RC00840437-DE			160						11.4			
	RC00590614-DE			182.6						14.3			
	RC00440859-DE	150	177	182.6	160	115	7	2	-	14.3			
400 V	RC43000020-DE	84	113	96	101	66	5	7.5	2	1.22			
	RC27000030-DE			105						9.5	1.60		
	RC14000047-DE										116	9.5	1.95
	RC10100069-DE												3.70
	RC06400116-DE	108	135	133	120	82	6.5	9.5	9.5	5.20			
	RC04410167-DE	120	152	136	135	94	7	7	-	6.00			
	RC03350219-DE			146						11.4			
	RC02330307-DE			160						14.3			
	RC01750430-DE			182.6						14.3			

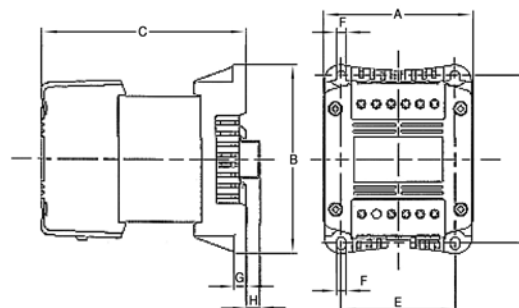

Output AC Reactor

Voltage class	Model 3G3AX-□	Dimensions (Unit: mm)						Weight (kg)
		A	B2	C2	D	E	F	
200 V	RAO11500026-DE	120	70	120	80	52	5.5	1.78
	RAO07600042-DE	120	70	120	80	52	5.5	1.78
	RAO04100075-DE	120	80	120	80	62	5.5	2.35
	RAO03000105-DE	120	80	120	80	62	5.5	2.35
	RAO01830180-DE	180	85	190	140	55	6	5.5
	RAO01150220-DE	180	85	190	140	55	6	5.5
	RAO00950320-DE	180	85	205	140	55	6	6.5
	RAO00630430-DE	180	95	205	140	65	6	9.1
RAO00490640-DE	180	95	205	140	65	6	9.1	
400 V	RAO16300038-DE	120	70	120	80	52	5.5	1.78
	RAO11800053-DE	120	80	120	80	52	5.5	2.35
	RAO07300080-DE	120	80	120	80	62	5.5	2.35
	RAO04600110-DE	180	85	190	140	55	6	5.5
	RAO03600160-DE	180	85	205	140	55	6	6.5
	RAO02500220-DE	180	95	205	140	55	6	9.1
RAO02000320-DE	180	105	205	140	85	6	11.7	



Reactors

Input AC Reactor

3-phase 200 VAC				3-phase 400 VAC			
Max. applicable motor output	Model 3G3AX-□	Current value	Inductance	Max. applicable motor output	Model 3G3AX-□	Current value	Inductance
1.5 kW (2 HP)	RAI02800080-DE	8.0 A	2.8 mH	1.5 kW (2 HP)	RAI07700050-DE	5.0 A	7.7 mH
3.7 kW (5 HP)	RAI00880200-DE	20.0 A	0.88 mH	4.0 kW (5 1/2 HP)	RAI03500100-DE	10.0 A	3.5 mH
7.5 kW (10 HP)	RAI00350335-DE	33.5 A	0.35 mH	7.5 kW (10 HP)	RAI01300170-DE	17.0 A	1.3 mH
15 kW (20 HP)	RAI00180670-DE	67.0 A	0.18 mH	15 kW (20 HP)	RAI00740335-DE	33.5 A	0.74 mH



DC Reactor

1-phase 200 VAC		3-phase 200 VAC					3-phase 400 VAC				
Drive 3G3MX2-□	Model 3G3AX-□	Max. applicable motor output	Drive 3G3MX2-□	Model 3G3AX-□	Current value	Inductance	Max. applicable motor output	Drive 3G3MX2-□	Model 3G3AX-□	Current value	Inductance
AB001	RC10700032-RE	0.2 kW (1/4 HP)	A2001	RC21400016-DE	1.6 A	21.4 mH	0.4 kW (1/2 HP)	A4004	RC43000020-DE	2.0 A	43.0 mH
AB002		0.4 kW (1/2 HP)	A2002				0.7 kW (1 HP)	A4007	RC27000030-DE	3.0 A	27.0 mH
AB004	RC06750061-RE	0.7 kW (1 HP)	A2004	RC10700032-DE	3.2 A	10.7 mH	1.5 kW (2 HP)	A4015	RC14000047-DE	4.7 A	14.0 mH
AB007	RC03510093-RE	1.5 kW (2 HP)	A2007	RC06750061-DE	6.1 A	6.75 mH	2.2 kW (3 HP)	A4022	RC10100069-DE	6.9 A	10.1 mH
AB015	RC02510138-RE	2.2 kW (3 HP)	A2015	RC03510093-DE	9.3 A	3.51 mH	3.0 kW (4 HP)	A4030	RC08250093-DE	9.3 A	8.25 mH
AB022	RC01600223-RE	3.7 kW (5 HP)	A2022	RC02510138-DE	13.8 A	2.51 mH	4.0 kW (5 1/2 HP)	A4040	RC06400116-DE	11.6 A	6.40 mH
-		5.5 kW (7 1/2 HP)	A2037	RC01600223-DE	22.3 A	1.60 mH	5.5 kW (7 1/2 HP)	A4055	RC04410167-DE	16.7 A	4.41 mH
		7.5 kW (10 HP)	A2055	RC01110309-DE	30.9 A	1.11 mH	7.5 kW (10 HP)	A4075	RC03350219-DE	21.9 A	3.35 mH
		11.0 kW (15 HP)	A2075	RC00840437-DE	43.7 A	0.84 mH	11.0 kW (15 HP)	A4011	RC02330307-DE	30.7 A	2.33 mH
		15.0 kW (20 HP)	A2011	RC00590614-DE	61.4 A	0.59 mH	15.0 kW (20 HP)	A4015	RC01750430-DE	43.0 A	1.75 mH
			A2015	RC00440859-DE	85.9 A	0.44 mH					



Output AC Reactor

3-phase 200 VAC					3-phase 400 VAC								
Max. applicable motor output	Model 3G3MX2-□	Model 3G3AX-□	Current value	Inductance	Max. applicable motor output	Model 3G3MX2-□	Model 3G3AX-□	Current value	Inductance				
0.4 kW (1/2 HP)	A2001/A2002/A2004 AB001/AB002/AB004	RAO11500026-DE	2.6 A	11.50 mH	1.5 kW (2 HP)	A4004/A4007/A4015	RAO16300038-DE	3.8 A	16.30 mH				
0.75 kW (1 HP)										A2007/AB007	RAO07600042-DE	4.2 A	7.60 mH
1.5 kW (2 HP)										A2015/AB015	RAO04100075-DE	7.5 A	4.10 mH
2.2 kW (3 HP)	A2022/AB022	RAO03000105-DE	10.5 A	3.00 mH	2.2 kW (3 HP)	A4022	RAO11800053-DE	5.3 A	11.80 mH				
3.7 kW (5 HP)	A2037	RAO01830160-DE	16.0 A	1.83 mH	4.0 kW (5 1/2 HP)	A4030/A4040	RAO07300080-DE	8.0 A	7.30 mH				
5.5 kW (7 1/2 HP)	A2055	RAO01150220-DE	22.0 A	1.15 mH	5.5 kW (7 1/2 HP)	A4055	RAO04600110-DE	11.0 A	4.60 mH				
7.5 kW (10 HP)	A2075	RAO00950320-DE	32.0 A	0.95 mH	7.5 kW (10 HP)	A4075	RAO03600160-DE	16.0 A	3.60 mH				
11.0 kW (15 HP)	-	RAO00630430-DE	43.0 A	0.63 mH	11.0 kW (15 HP)	-	RAO02500220-DE	22.0 A	2.50 mH				
15.0 kW (20 HP)	-	RAO00490640-DE	64.0 A	0.49 mH	15.0 kW (20 HP)	-	RAO02000320-DE	32.0 A	2.00 mH				

Accessories

Chokes

Model 3G3AX-□	Diameter	Motor	Description	Dimensions (Unit: mm)							Weight (kg)
	d	kW		HP	L	W	H	X	Y	m	
FEJ2102-RE	21	< 2.2	For 2.2 kW (3.0 HP) motors or below	< 3.0	85	22	46	70	-	5	0.1
FEJ2515-RE	25	< 15	For 15 kW (20 HP) motors or below	< 20	105	25	62	90	-	5	0.2
FEJ5045-RE	50	< 45	For 45 kW (60 HP) motors or below	< 60	150	50	110	125	30	5	0.7



Resistor

Model	Figure	Dimensions (Unit: mm)					Weight (kg)
		L	H	M	I	T	
3G3AX-REM00K1400-IE	1	105	27	36	94	-	0.2
3G3AX-REM00K2070-IE							
3G3AX-REM00K2120-IE							
3G3AX-REM00K2200-IE							
3G3AX-REM00K4075-IE		200	27	36	189	-	
3G3AX-REM00K4035-IE							
3G3AX-REM00K4030-IE							
3G3AX-REM00K5120-IE							
3G3AX-REM00K6100-IE	320	27	36	309	-		
3G3AX-REM00K6035-IE							
3G3AX-REM00K9070-IE	2	200	62	100	74	-	1.41
3G3AX-REM00K9020-IE							
3G3AX-REM00K9017-IE							
3G3AX-REM01K9070-IE	3	365	73	105	350	70	4
3G3AX-REM01K9017-IE							
3G3AX-REM02K1070-IE	4	310	100	240	295	210	7
3G3AX-REM02K1017-IE							
3G3AX-REM03K5035-IE		365	100	240	350	210	
3G3AX-REM03K5010-IE							

3G3AX-REM00K1200



FIGURE 2

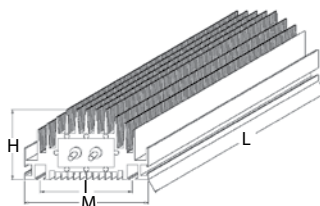

FIGURE 4

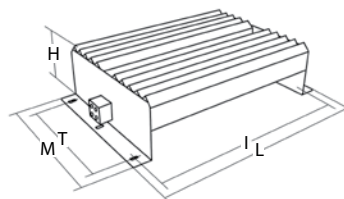

FIGURE 1

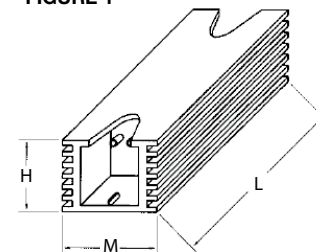
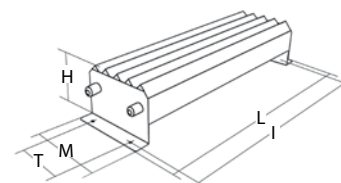

FIGURE 3



Standard Connections



*1 Connect to terminals L1 and N on a single-phase, 200-V AC Drive (3G3MX2-AB□□□).
 *2 Optional.

Main Circuit Terminals

Terminal symbol	Terminal name	Description
R/L1, L1, S/L2, T/L3, N	Main power supply input terminal	Connect the input AC power supply. Connect to terminals L1 and N on a single-phase, 200-V AC Drive (3G3MX2-AB□□□).
U/T1, V/T2, W/T3	Drive output terminal	Connect a 3-phase motor.
+1, P/+2	DC reactor connection terminal	Remove the shunting bar between terminals +1 and P/+2, and connect the optional DC reactor.
P/+2, RB	Braking Resistor connection terminal	Connect optional braking resistors. (If a braking torque is required)
P/+2, N/-	Regenerative braking unit connection terminal	Connect optional regenerative braking units. (When braking torque is required or the built-in braking circuit is not sufficient)
G	Ground terminal	This is a ground terminal. Connect this terminal to the ground. Provide Class D grounding for 200 V class models, and class C grounding for 400 V class models. On 200 V class models of 3.7 kW or below and 400 V class models of 4.0 kW or below, the ground terminal is located on the cooling fin.

Control Circuit Terminals

Terminal symbol		Terminal name	Description	Specifications	
Analog	Power supply	SC	Input signal common	This is a common terminal used by the internal power supply, digital input and analog input/output terminals.	
		FS	Frequency reference power supply	10 VDC power supply for the FV terminal. Allowable max. current: 7 mA	
	Frequency setting input	FV	Frequency reference input terminal (analog voltage input)	Use this terminal if the frequency reference is provided by 0 to 10 VDC voltage input. Input impedance Approx. 10 kΩ Allowable input voltage range -0.3 to +12 VDC	
		FI	Frequency reference terminal (analog current input)	Use this terminal if the frequency reference is provided by 4 to 20 mA current input. Input impedance 100 Ω Allowable input range 0 to 24 mA	
	Sensor input	S5/TH	External thermistor input (also used as multi-function input terminal)	Connect an external thermistor between the SCs, to trip the Drive when a temperature error occurs. (The drive will trip when the input from thermistor is approx. 3 kΩ or higher.) Since this input is also used as the multifunction input terminal, setting of C005 is required. PTC type	
Output	AM	Multi-function analog output (voltage)	Specified signals can be output using voltage signals of 0 to 10 VDC. AM		
Digital	Power supply	SC	Input signal common	This is a common terminal used by the internal power supply, digital input and analog input/output terminals.	
		P24	Power supply terminal for input signal	24 VDC power supply for contact input signal. This is used as a common terminal if the source logic is input. Allowable max. current: 100 mA	
		PSC	Power supply terminal for input terminal	Sink logic input: Shorted with P24 Source logic input: Shorted with SC To drive the contact input using an external power supply, remove the shorting bar.	
	Input	Contact	S7/EB S6 S5/TH S4/GS2 S3/GS1 S2 S1	Multi-function input terminal	Select 7 functions from among 59, and allocate them to terminals S1 through S7/EB. Both sink and source logics are supported. Voltage between each input and PSC ON voltage: 18 V min. OFF voltage: 3 V max. Allowable max. voltage: 27 VDC Load current: 5 mA (at 24 V)
			S4/GS2 S3/GS1	Safety input	Enabled when the safety function selector switch is turned ON.
	Input	Pulse	RP	Pulse input-A	A pulse input for frequency setting. (Take note that the internal circuit is different from input terminals S7/EB.) Input pulse 32 kHz max. Voltage between input and SC ON voltage: 4 V min. OFF voltage: 1 V max. Allowable max. voltage: 27 VDC
			S7/EB	Pulse input-B	A pulse input for frequency setting. (Take note that the internal circuit is different from input terminal RP.) Input pulse 1.8 kHz max. ON voltage: 18 V min. OFF voltage: 3 V max. Allowable max. voltage: 27 VDC Load current: 5 mA (at 24 V)
	Output	Open collector	P1/EDM P2	Multi-function output terminal	Select 2 functions from among 43, and allocate them to terminals P1 through P2. Both sink and source logics are supported. Open collector output Between each terminal and PC Allowable max. voltage: 27 V Allowable max. current: 50 mA Voltage drop when ON: 4 V max.
			P1/EDM	Safety monitor	Enabled when the EDM function selector switch is ON.
		Relay	MA MB	Relay output terminal	Select the desired functions from among 43 functions, and allocate them to these terminals. SPDT contact. The factory default of Relay Output (MA, MB) Contact Selection (C036) is NC contact between MA-MC, and NO contact between MB-MC.
MC			Relay output common		
Pulse	MP	Pulse output	Pulses are output. Output pulse: 32 kHz max. Output voltage: 10 VDC Allowable max. current: 2 mA		
Serial communication	RS+ RS-	Modbus port (RS-485)	RS-485 port RS+ RS-485 differential (+) signal RS- RS-485 differential (-) signal	Max. speed: 115.2 kbps Built-in Terminal Resistor: 200 Ω Slide switch selection	

Side by side mounting

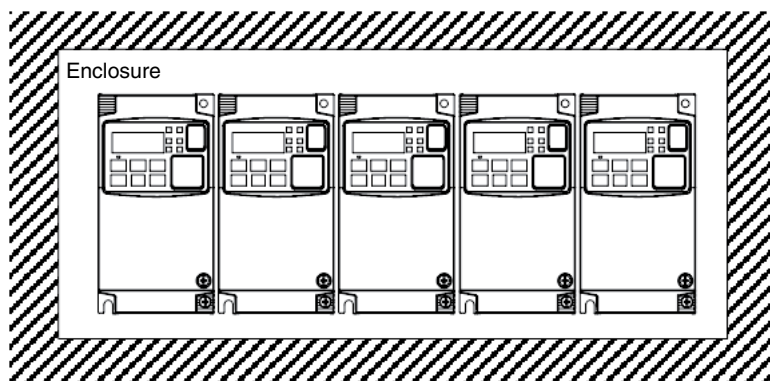

Heat Loss
Single-phase 200 V class

Model 3G3MX2-□		AB001	AB002	AB004	AB007	AB015	AB022
Drive capacity kVA	200V VT	0.4	0.6	1.2	2.0	3.3	4.1
	200V CT	0.2	0.5	1.0	1.7	2.7	3.8
	240V VT	0.4	0.7	1.4	2.4	3.9	4.9
	240V CT	0.3	0.6	1.2	2.0	3.3	4.5
Rated current (A) VT		1.2	1.9	3.4	6.0	9.6	12.0
Rated current (A) CT		1.0	1.6	3.0	5.0	8.0	11.0
Total heat loss		12	22	30	48	79	104
Efficiency at rated load		89.5	90	93	94	95	95.5
Cooling method		Self cooling				Forced-air-cooling	

Three-phase 200 V class

Model 3G3MX2-□		A2001	A2002	A2004	A2007	A2015	A2022	A2037	A2055	A2075	A2110	A2150
Drive capacity kVA	200 VT	0.4	0.6	1.2	2.0	3.3	4.1	6.7	10.3	13.8	19.3	23.9
	200 CT	0.2	0.5	1.0	1.7	2.7	3.8	6.0	8.6	11.4	16.2	20.7
	240 VT	0.4	0.7	1.4	2.4	3.9	4.9	8.1	12.4	16.6	23.2	28.6
	240 CT	0.3	0.6	1.2	2.0	3.3	4.5	7.2	10.3	13.7	19.5	24.9
Rated current (A) VT		1.2	1.9	3.4	6.0	9.6	12.0	19.6	30.0	40.0	56.0	69.0
Rated current (A) CT		1.0	1.6	3.0	5.0	8.0	11.0	17.5	25.0	33.0	47.0	60.0
Total heat loss		12	22	30	48	79	104	154	229	313	458	625
Efficiency at rated load		89.5	90	93	94	95	95.5	96	96	96	96	96
Cooling method		Self cooling					Forced-air-cooling					

Three-phase 400 V class

Model 3G3MX2-□		A4004	A4007	A4015	A4022	A4030	A4040	A4055	A4075	A4110	A4150
Drive capacity kVA	380V VT	1.3	2.6	3.5	4.5	5.7	7.3	11.5	15.1	20.4	25.0
	380V CT	1.1	2.2	3.1	3.6	4.7	6.0	9.7	11.8	15.7	20.4
	480V VT	1.7	3.4	4.4	5.7	7.3	9.2	14.5	19.1	25.7	31.5
	480V CT	1.4	2.8	3.9	4.5	5.9	7.6	12.3	14.9	19.9	25.7
Rated current (A) VT		2.1	4.1	5.4	6.9	8.8	11.1	17.5	23.0	31.0	38.0
Rated current (A) CT		1.8	3.4	4.8	5.5	7.2	9.2	14.8	18.0	24.0	31.0
Total heat loss		35	56	96	116	125	167	229	296	411	528
Efficiency at rated load		92	93	94	95	96	96	96	96.2	96.4	96.6
Cooling method		Self cooling				Forced-air-cooling					

Ordering Information

3G3MX2 AC Drives

Specifications							Model
Voltage class	Constant torque (Heavy load)			Variable torque (Light load)			Standard
	Max motor kW	Max motor HP	Rated current A	Max motor kW	Max motor HP	Rated current A	
1-phase 200 VAC	0.1	1/8	1.0	0.2	1/4	1.2	3G3MX2-AB001
	0.2	1/4	1.6	0.4	1/2	1.9	3G3MX2-AB002
	0.4	1/2	3.0	0.55	3/4	3.5	3G3MX2-AB004
	0.75	1	5.0	1.1	1 1/2	6.0	3G3MX2-AB007
	1.5	2	8.0	2.2	3	9.6	3G3MX2-AB015
	2.2	3	11.0	3.0	4	12.0	3G3MX2-AB022
3-phase 200 VAC	0.1	1/8	1.0	0.2	1/4	1.2	3G3MX2-A2001
	0.2	1/4	1.6	0.4	1/2	1.9	3G3MX2-A2002
	0.4	1/2	3.0	0.55	3/4	3.5	3G3MX2-A2004
	0.75	1	5.0	1.1	1 1/2	6.0	3G3MX2-A2007
	1.5	2	8.0	2.2	3	9.6	3G3MX2-A2015
	2.2	3	11.0	3.0	4	12.0	3G3MX2-A2022
	3.7	5	17.5	5.5	7 1/2	19.6	3G3MX2-A2037
	5.5	7 1/2	25.0	7.5	10	30.0	3G3MX2-A2055
	7.5	10	33.0	11	15	40.0	3G3MX2-A2075
3-phase 400 VAC	0.4	1/2	1.8	0.75	1	2.1	3G3MX2-A4004
	0.75	1	3.4	1.5	2	4.1	3G3MX2-A4007
	1.5	2	4.8	2.2	3	5.4	3G3MX2-A4015
	2.2	3	5.5	3.0	4	6.9	3G3MX2-A4022
	3.0	4	7.2	4.0	5	8.8	3G3MX2-A4030
	4.0	5	9.2	5.5	7 1/2	11.1	3G3MX2-A4040
	5.5	7 1/2	14.8	7.5	10	17.5	3G3MX2-A4055
	7.5	10	18.0	11	15	23.0	3G3MX2-A4075
	11	15	24.0	15	20	31.0	3G3MX2-A4110
	15	20	31.0	18.5	25	38.0	3G3MX2-A4150

Accessories

Types	Model	Description	Functions
Digital operator	3G3AX-OP05	LCD remote operator	5 Line LCD remote operator with copy function, cable length max. 3m.
	3G3AX-CAJOP300-EE	Remote operator cable	3 meters cable for connecting remote operator
Accessories	3G3AX-CUSBM002-E	PC configuration cable	Mini USB to USB connector cable

Computer Software

Item	Description	Functions
CX-Drive	AC Drive/Servo Programming software	Set, transfer and compare parameters; perform test runs and adjustment; perform monitoring and data tracing for Omron drives and servos included in CX-One software.
CX-One	All-in-one Automation software	Program, configure and simulate operations for PLCs, HMIs, networks, motion control systems, temperature and process controllers.

Note: Software runs on the following OS: Windows 2000 (Service Pack 3a or higher), XP, Vista or Windows 7.

ALL DIMENSIONS SHOWN ARE IN MILLIMETERS.
 To convert millimeters into inches, multiply by 0.03937. To convert grams into ounces, multiply by 0.03527.

Specifications are subject to change without notice.

Ordering Information

Communication Option Boards



Types	Model	Description	Functions
Communication options	3G3AX-MX2-PRT	Profibus option card	Used for running or stopping the drive, setting or referencing parameters, and monitoring output frequency, output current, or similar items through Profibus communications with the host controller.
	3G3AX-MX2-DRT	DeviceNet option card	Used for running or stopping the drive, setting or referencing parameters, and monitoring output frequency, output current, or similar items through DeviceNet communications with the host controller.
	3G3AX-MX2-ECT	EtherCAT option card	Used for running or stopping the drive, setting or referencing parameters, and monitoring output frequency, output current, or similar items through EtherCAT communications with the host controller.
	3G3AX-MX2-CRT	CompoNet option card	Used for running or stopping the drive, setting or referencing parameters, and monitoring output frequency, output current, or similar items through CompoNet communications with the host controller.
	3G3AX-MX2-ML2	Mechatrolink II option card	Used for running or stopping the drive, setting or referencing parameters, and monitoring output frequency, output current, or similar items through Mechatrolink II communications with the host controller.
	3G3AX-MX2-EIP-A	EtherNet/IP option card	Used for running or stopping the drive, setting or referencing parameters, and monitoring output frequency, output current, or similar items through EtherNet/IP communications with the host controller.

Braking Unit, Braking Resistor Unit

Voltage	Drive					Braking resistor unit					
	Max. motor capacity		Drive 3G3MX2-□		Connectable min. resistance Ω	Drive mounted type (3%ED, 10 sec max)		Braking torque %	Drive mounted type (10%ED, 10 sec max)		Braking torque %
	kW	HP	3-phase	1-phase		Model 3G3AX-□	Resistance Ω		Model 3G3AX-□	Resistance Ω	
200 V (1-phase/ 3-phase)	0.12	1/8	A2001	B001	100	REM00K1400-IE	400	200	REM00K1400-IE	400	200
	0.2	1/4	A2002	B002	100			180			180
	0.5	1/2	A2004	B004	100	REM00K1200-IE	200	180	REM00K1200-IE	200	180
	0.7	1	A2007	B007	50			100			200
	1.5	2	A2015	B015	50	REM00K2070-IE	70	140	REM00K4075-IE	75	130
	2.2	3	A2022	B022	35			90			180
	3.7	5	A2037	-	35	REM00K4075-IE	75	50	REM00K6035-IE	35	100
	5.5	7.5	A2055	-	20	REM00K4035-IE	35	75	REM00K9017-IE	17	150
	7.5	10	A2075	-	17			55	110		
	11	15	A2110	-	17	REM00K6035-IE	35	40	REM02K1017-IE	17	75
15	20	A2150	-	10	REM00K9017-IE	17	55	REM03K5010-IE	10	95	
400 V (3-phase)	0.5	1/2	A4004	-	180	REM00K1400-IE	400	200	REM00K1400-IE	400	200
	1	1	A4007	-				200			200
	1.5	2	A4015	-		REM00K1200-IE	200	190	REM00K2200-IE	200	190
	2.2	3	A4022	-	100	REM00K2200-IE	200	130	REM00K5120-IE	120	200
	3	4	A4030	-		REM00K2120-IE	120	160			160
	4	5	A4040	-	70	REM00K4075-IE	75	120	REM00K6100-IE	100	140
	5.5	7.5	A4055	-				140	150		
	7.5	10	A4075	-		100	110				
	11	15	A4110	-	35	REM00K6100-IE	100	50	REM02K1070-IE	70	75
15	20	A4150	-	REM00K9070-IE		70	55	REM03K5035-IE	35	110	

OMRON AUTOMATION AND SAFETY • THE AMERICAS HEADQUARTERS • Schaumburg, IL USA • 847.843.7900 • 800.556.6766 • www.omron247.com

OMRON CANADA, INC. • HEAD OFFICE

Toronto, ON, Canada • 416.286.6465 • 866.986.6766 • www.omron247.com

OMRON ELECTRONICS DE MEXICO • HEAD OFFICE

México DF • 52.55.59.01.43.00 • 001.800.556.6766 • mela@omron.com

OMRON ELECTRONICS DE MEXICO • SALES OFFICE

Apodaca, N.L. • 52.81.11.56.99.20 • 001.800.556.6766 • mela@omron.com

OMRON ELETRÔNICA DO BRASIL LTDA • HEAD OFFICE

São Paulo, SP, Brasil • 55.11.2101.6300 • www.omron.com.br

OMRON ARGENTINA • SALES OFFICE

Cono Sur • 54.11.4783.5300

OMRON CHILE • SALES OFFICE

Santiago • 56.9.9917.3920

OTHER OMRON LATIN AMERICA SALES

54.11.4783.5300

OMRON EUROPE B.V. • Wegalaan 67-69, NL-2132 JD, Hoofddorp, The Netherlands. • Tel: +31 (0) 23 568 13 00 • Fax: +31 (0) 23 568 13 88 • www.industrial.omron.eu

Authorized Distributor:

Automation Control Systems

- Machine Automation Controllers (MAC) • Programmable Controllers (PLC)
- Operator interfaces (HMI) • Distributed I/O • Software

Drives & Motion Controls

- Servo & AC Drives • Motion Controllers & Encoders

Temperature & Process Controllers

- Single and Multi-loop Controllers

Sensors & Vision

- Proximity Sensors • Photoelectric Sensors • Fiber-Optic Sensors
- Amplified Photomicrosensors • Measurement Sensors
- Ultrasonic Sensors • Vision Sensors • RFID/Code Readers

Industrial Components

- Relays • Pushbuttons & Indicators • Limit and Basic Switches • Timers
- Counters • Metering Devices • Power Supplies

Safety

- Laser Scanners • Safety Mats • Edges and Bumpers
- Programmable Safety Controllers • Light Curtains • Safety Relays
- Safety Interlock Switches



Компания «ЭлектроПласт» предлагает заключение долгосрочных отношений при поставках импортных электронных компонентов на взаимовыгодных условиях!

Наши преимущества:

- Оперативные поставки широкого спектра электронных компонентов отечественного и импортного производства напрямую от производителей и с крупнейших мировых складов;
- Поставка более 17-ти миллионов наименований электронных компонентов;
- Поставка сложных, дефицитных, либо снятых с производства позиций;
- Оперативные сроки поставки под заказ (от 5 рабочих дней);
- Экспресс доставка в любую точку России;
- Техническая поддержка проекта, помощь в подборе аналогов, поставка прототипов;
- Система менеджмента качества сертифицирована по Международному стандарту ISO 9001;
- Лицензия ФСБ на осуществление работ с использованием сведений, составляющих государственную тайну;
- Поставка специализированных компонентов (Xilinx, Altera, Analog Devices, Intersil, Interpoint, Microsemi, Aeroflex, Peregrine, Syfer, Eurofarad, Texas Instrument, Miteq, Cobham, E2V, MA-COM, Hittite, Mini-Circuits, General Dynamics и др.);

Помимо этого, одним из направлений компании «ЭлектроПласт» является направление «Источники питания». Мы предлагаем Вам помощь Конструкторского отдела:

- Подбор оптимального решения, техническое обоснование при выборе компонента;
- Подбор аналогов;
- Консультации по применению компонента;
- Поставка образцов и прототипов;
- Техническая поддержка проекта;
- Защита от снятия компонента с производства.



Как с нами связаться

Телефон: 8 (812) 309 58 32 (многоканальный)

Факс: 8 (812) 320-02-42

Электронная почта: org@eplast1.ru

Адрес: 198099, г. Санкт-Петербург, ул. Калинина, дом 2, корпус 4, литера А.