

- ◆ 2ch DC/DC Controller (Step-up + Step-down)
- ◆ Input Voltage Range 0.9V ~ 10.0V
- ◆ Output Voltage Externally Set-Up
- ◆ Switching Frequency 180kHz (±15%)
- ◆ Maximum Duty Cycle Step-up 80% (Typ.)  
Step-down 100%
- ◆ PWM, PWM/PFM Switching Control
- ◆ High Efficiency Step-up 85% (Typ.)  
Step-down 92% (Typ.)
- ◆ Small MSOP-10 package

### General Description

The XC9502 series are PWM controlled, PWM/PFM automatic switching controlled, multi-functional, 2 channel step-up and down DC/DC controller ICs. With 0.9V of standard voltage supply internal, and using externally connected components, the output 1 voltage (step-up DC/DC controller) can be set freely within a range of 1.5V to 30V. Since the output 2 (step-down DC/DC controller) has a built-in 0.9V reference voltage (accuracy ±2%), 0.9V to 6.0V can be set using external components. With a 180kHz frequency, the size of the external components can be reduced. Switching frequencies of 300kHz & 500kHz are also available as custom-designed products.

The control of the XC9502 series can be switched between PWM control and PWM/PFM automatic switching control using external signals. Control switches from PWM to PFM during light loads when automatic switching is selected and the series is highly efficient from light loads through to large output currents.

Noise is easily reduced with PWM control since the frequency is fixed. The series gives freedom of control selection so that control suited to the application can be selected. Soft-start time is internally set to 10msec (Output 1) and offers protection against in-rush currents when the power is switched. This also prevents voltage overshoot.

### Typical Application Circuit

#### XC9502B092A Input :

2 cell, VOUT① : 3.3V, VOUT② : 1.8V

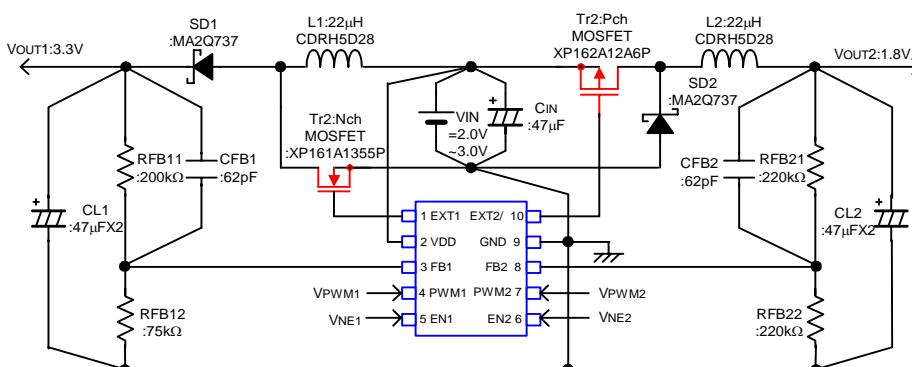

### Applications

- PDAs
- Palm Top Computers
- Portable Audio Systems
- Various Multi-Function Power Supplies

### Features

2ch DC/DC Controller

Output 1 : Step-up DC/DC Controller

Output 2 : Step-down DC/DC Controller

Power Supply Voltage Range : 2.0V ~ 10V

Output Voltage Range

Output 1 (Step-up) : 1.5V ~ 30.0V

Can be set freely with 0.9V (±2.0%) of reference voltage supply and external components.

Output 2 (Step-down) : 0.9V ~ 6.0V

Can be set freely with 0.9V (±2.0%) of reference voltage supply and external components.

Oscillation Frequency : 180kHz ±15%  
(300kHz, 500kHz custom)

Output Current Output 1 : more than 300mA (VIN=1.8V, VOUT=3.3V)  
Output 2 : more than 1000mA (VIN=3.3V, VOUT=1.8V)

Stand-By Function : 3.0μA (MAX.)

Package : MSOP-10

Soft-Start Time : 10 ms (internally set)

### Typical Performance Characteristics

#### XC9502B093A (300kHz, VOUT1:3.3V, VOUT2:1.8V)

L1=15μH, L2=22μH(CDRH5D28), CL1, CL2=92μF(Tantalum)  
SD1, SD2: CMS02, Tr1: XP161A1355P, Tr2: XP162A12A6P

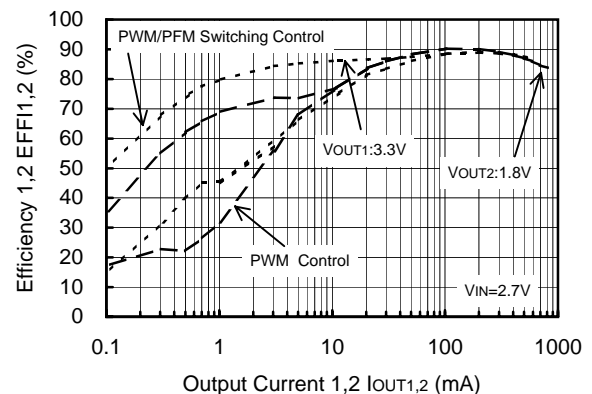

### ■ Pin Configuration

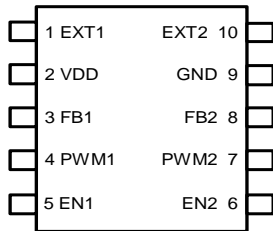

MSOP-10  
(TOP VIEW)

### ■ Pin Assignment

PIN NUMBER	PIN NAME	FUNCTIONS
1	EXT 1	Channel 1: External Transistor Drive Pin <Connected to Nch Power MOSFET Gate>
2	VDD	Supply Voltage
3	FB1	Channel 1 : Output Voltage Monitor Feedback Pin <Threshold value : 0.9V. Output voltage can be set freely by connecting split resistors between VOUT1 and Ground.>
4	PWM1	Channel 1 : PWM/PFM Switching Pin <Control Output 1. PWM control when connected to VDD, PWM / PFM auto switching when connected to Ground. >
5	EN1	Channel 1 : Enable Pin <Connected to Ground when Output 1 is in stand-by mode. Connected to VDD when Output 1 is active. EXT1 is low when in stand-by mode.>
6	EN2	Channel 2 : Enable Pin <Connected to Ground when Output 2 is in stand-by mode. Connected to VDD when Output 2 is active. EXT2/ is high when in stand-by mode.>
7	PWM2	Channel 2 : PWM/PFM Switching Pin <Control Output 2. PWM control when connected to VDD, PWM / PFM auto switching when connected to Ground.>
8	FB2	Channel 2 : Output Voltage Monitor Feedback Pin <Threshold value : 0.9V. Output voltage can be set freely by connecting split resistors between VOUT2 and Ground.>
9	GND	Ground
10	EXT2/	Channel 2 : External Transistor Drive Pin <Connected to Pch Power MOSFET Gate>

### ■ Ordering Information

XC9502①②③④⑤⑥

DESIGNATOR	SYMBOL	DESCRIPTION	
①	B	Standard (10 Pin)	
②	0	FB Voltage	
③	9	0.9V	
④		Switching Frequency	
	2	180kHz	
	3	300kHz (custom)	
	5	500kHz (custom)	
⑤	A	Package	MSOP-10
⑥	R	Embossed Tape	Standard Feed
	L	Embossed Tape	Reverse Feed

### Absolute Maximum Ratings

$T_a=25^{\circ}\text{C}$

PARAMETER	SYMBOL	RATINGS	UNITS
VDD Pin Voltage	VDD	- 0.3 ~ 12	V
FB1, 2 Pin Voltage	VFB	- 0.3 ~ 12	V
EN1, 2 Pin Voltage	VEN	- 0.3 ~ 12	V
PWM1,2 Pin Voltage	VPWM	- 0.3 ~ 12	V
EXT1, 2 Pin Voltage	VEXT	- 0.3 ~ VDD + 0.3	V
EXT1, 2 Pin Current	IEXT	$\pm 100$	mA
Power Dissipation	Pd	150	mW
Operating Ambient Temperature	Topr	- 40 ~ + 85	$^{\circ}\text{C}$
Storage Temperature	Tstg	- 55 ~ + 125	$^{\circ}\text{C}$

\* Voltage goes to Ground.

### Block Diagram

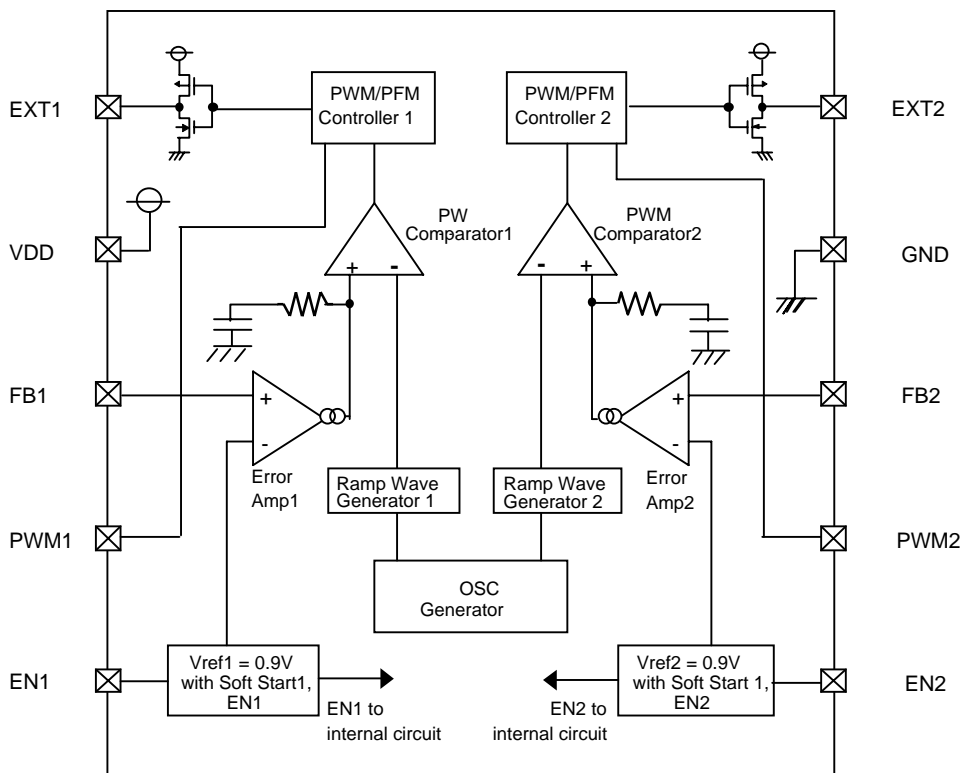

### Electrical Characteristics XC9502B092

Common Characteristics			(FOSC=180kHz)			Ta=25°C		
PARAMETER	SYMBOL	CONDITIONS	MIN.	TYP.	MAX.	UNITS	TEST CIRCUIT	
Supply Voltage (note 1)	VDD		2.0	-	10.0	V	①	
Max. Input Voltage	VIN		10.0	-	-	V	①	
Output Voltage Range (note 3)	VOUTSET	VDD ≥ 2.0V, IOU1, 2=1mA	VOUT1	0.9	-	-	V	①
		VDD ≠ VOUT1	VOUT2	0.9	-	VIN	V	
		VIN ≥ 0.9V, IOU1, 2=1mA	VOUT1	2.0	-	10.0	V	②
		VDD=VOUT1	VOUT2	0.9	-	VIN	V	
Supply Current 1	IDD1	FB1, 2=0V	-	70	160	μA	③	
Supply Current 1-1	IDD1-1	EN1=3.0V, EN2=0V, FB1=0V	-	60	120	μA	③	
Supply Current 1-2	IDD1-2	EN2=3.0V, EN1=0V, FB2=0V	-	50	110	μA	③	
Supply Current 1-3	IDD1-3	FB1=0V, FB2=1.0V	-	70	160	μA	③	
Supply Current 1-4	IDD1-4	FB1=1.0V, FB2=0V	-	60	130	μA	③	
Supply Current 2	IDD2	FB1, 2=1.0V	-	60	130	μA	③	
Stand-by Current	ISTB	Same as IDD1, EN1=EN2=0V	-	1.0	3.0	μA	③	
Switching Frequency	FOSC	Same as IDD1	153	180	207	kHz	③	
EN1,2 "High" Voltage	VENH	FB1,2=0V	0.65	-	-	V	③	
EN1,2 "Low" Voltage	VENL	FB1,2=0V	-	-	0.20	V	③	
EN1,2 "High" Current	IENH	EN1,2=3.0V	-	-	0.50	μA	③	
EN1,2 "Low" Current	IENL	EN1,2=0V, FB1,2=3.0V	-	-	-0.50	μA	③	
PWM1,2 "High" Current	IPWMH	FB1, 2=3.0V, PWM=3.0V	-	-	0.50	μA	③	
PWM1,2 "Low" Current	IPWML	FB1, 2=3.0V, PWM=0V	-	-	-0.50	μA	③	
FB1,2 "High" Current	IFBH	FB1, 2=3.0V	-	-	0.50	μA	③	
FB1,2 "Low" Current	VFBL	FB1, 2=1.0V	-	-	-0.50	μA	③	

Unless otherwise stated, VDD=3.0V, PWM1,2=3.0V, EN1, 2 =3.0V

### Output 1 Characteristics Step-up Controller Ta=25°C

PARAMETER	SYMBOL	CONDITIONS	MIN.	TYP.	MAX.	UNITS	TEST CIRCUIT
FB1 Voltage	VFB1	VDD=3.0V, VIN=1.5V, IOU1=10mA	0.882	0.900	0.918	V	④
Operation Start-up Voltage1 (note 2)	VST1-1	Using Tr: 2SD1628, IOU1=1.0mA, RFB11=200kΩ, RFB12=75kΩ	-	-	0.9	V	②
		VDD ≠ VOUT1: IOU1=1mA	-	-	2.0	V	①
Oscillation Start-up Voltage1	VST2-1	FB1=0V	-	-	0.8	V	③
Maximum Duty Ratio1	MAXDTY1	Same as IDD1	75	80	85	%	③
Minimum Duty Ratio1	MINDTY1	Same as IDD2	-	-	0	%	③
PFM Duty Ratio1	PFMDTY1	No Load, VPWM1=0V	22	30	38	%	⑤
Efficiency1 (note 4)	EFFI1	IOU1=130mA N-ch MOSFET:XP161A1355P	-	85	-	%	⑤
Soft-Start Time1	TSS1	VOUT1 × 0.95V, EN1=0V → 0.65V	5.0	10.0	20.0	mS	⑤
EXT1 "High" ON Resistance	REXTBH1	FB1=0, EXT1=VDD-0.4V	-	28	47	Ω	⑥
EXT1 "Low" ON Resistance	REXTBL1	EN1=FB2=0V, EXT1=0.4V	-	22	30	Ω	⑥
PWM1 "High" Voltage	VPWMH1	No Load	0.65	-	-	V	⑤
PWM1 "Low" Voltage	VPWML1	No Load	-	-	0.20	V	⑤

Unless otherwise stated, VDD=EN1=PWM1=3.0V, EN2=PWM2=GND, EXT2=OPEN, FB2=OPEN, VIN=1.8V

### Output 2 Characteristics Step-down Controller Ta=25°C

PARAMETER	SYMBOL	CONDITIONS	MIN.	TYP.	MAX.	UNITS	TEST CIRCUIT
FB2 Voltage	VFB2	VIN=3.0V, IOU2=10mA	0.882	0.900	0.918	V	⑦
Minimum Operation Voltage	VINmin		-	-	2.0	V	①
Maximum Duty Ratio2	MAXDTY2	Same as IDD1	100	-	-	%	③
Minimum Duty Ratio2	MINDTY2	Same as IDD2	-	-	0	%	③
PFM Duty Ratio2	PFMDTY2	No Load, VPWM2=0V	22	30	38	%	⑧
Efficiency2 (note 4)	EFFI2	IOU2=250mA P-ch MOSFET : XP162A12A6P	-	92	-	%	⑧
Soft-Start Time2	TSS2	VOUT2 × 0.95V, EN2=0V → 0.65V	5.0	10.0	20.0	mS	⑧
EXT2 "High" ON Resistance	REXTBH2	EN2=0, EXT2=VDD-0.4V	-	28	47	Ω	⑥
EXT2 "Low" ON Resistance	REXTBL2	FB2=0V, EXT2=0.4V	-	22	30	Ω	⑥
PWM2 "High" Voltage	VPWMH2	No Load	0.65	-	-	V	⑧
PWM2 "Low" Voltage	VPWML2	No Load	-	-	0.20	V	⑧

Unless otherwise stated, VDD=EN2=PWM2=3.0V, PWM1=EN1=GND, EXT1=OPEN, FB1=OPEN, VIN=5.0V

- Notes
- Although the IC's step-up operations start from a VDD of 0.8V, the output voltage and switching frequency are stabilized at VDD ≥ 2.0V. Therefore, a VDD of more than 2.0V is recommended when VDD is supplied from VIN or other power sources.
  - Although the IC's switching operations start from a VIN of 0.9V, the IC's power supply pin (VDD) and output voltage monitor pin (FB1) should be connected to VOUT1. With operations from VIN=0.9V, the 2nd channel's (output 2) EN2 pin should be set to chip disable. Once output voltage VOUT1 is more than 2.0V, the EN2 pin should be set to chip enable.
  - Please be careful not to exceed the breakdown voltage level of the peripheral parts.
  - $EFFI = \left\{ \frac{(\text{Output voltage}) \times (\text{Output current})}{(\text{Input voltage}) \times (\text{Input Current})} \right\} \times 100$

### Electrical Characteristics XC9502B093

Common Characteristics			(FOSC=300kHz)			Ta=25°C		
PARAMETER	SYMBOL	CONDITIONS	MIN.	TYP.	MAX.	UNITS	TEST CIRCUIT	
Supply Voltage (note 1)	VDD		2.0	-	10.0	V	①	
Max. Input Voltage	VIN		10.0	-	-	V	①	
Output Voltage Range (note 3)	VOUTSET	VDD ≥ 2.0V, IOUT1, 2=1mA	VOUT1	0.9	-	-	V	①
		VDD ≠ VOUT1	VOUT2	0.9	-	VIN	V	
		VIN ≥ 0.9V, IOUT1, 2=1mA	VOUT1	2.0	-	10.0	V	②
		VDD=VOUT1	VOUT2	0.9	-	VIN	V	
Supply Current 1	IDD1	FB1, 2=0V	-	100	190	μA	③	
Supply Current 1-1	IDD1-1	EN1=3.0V, EN2=0V, FB1=0V	-	80	150	μA	③	
Supply Current 1-2	IDD1-2	EN2=3.0V, EN1=0V, FB2=0V	-	60	120	μA	③	
Supply Current 1-3	IDD1-3	FB1=0V, FB2=1.0V	-	100	190	μA	③	
Supply Current 1-4	IDD1-4	FB1=1.0V, FB2=0V	-	70	150	μA	③	
Supply Current 2	IDD2	FB1, 2=1.0V	-	70	150	μA	③	
Stand-by Current	ISTB	Same as IDD1, EN1=EN2=0V	-	1.0	3.0	μA	③	
Switching Frequency	FOSC	Same as IDD1	255	300	345	kHz	③	
EN1,2 "High" Voltage	VENH	FB1,2=0V	0.65	-	-	V	③	
EN1,2 "Low" Voltage	VENL	FB1,2=0V	-	-	0.20	V	③	
EN1,2 "High" Current	IENH	FB1,2=3.0V	-	-	0.50	μA	③	
EN1,2 "Low" Current	IENL	EN1,2=0V, FB1,2=3.0V	-	-	-0.50	μA	③	
PWM1,2 "High" Current	IPWMH	FB1, 2=3.0V, PWM=3.0V	-	-	-0.50	μA	③	
PWM1,2 "Low" Current	IPWML	FB1, 2=3.0V, PWM=0V	-	-	-0.50	μA	③	
FB1,2 "High" Current	IFBH	FB1, 2=3.0V	-	-	0.50	μA	③	
FB1,2 "Low" Current	VFBL	FB1, 2=1.0V	-	-	-0.50	μA	③	

Unless otherwise stated, VDD=3.0V, PWM1,2=3.0V, EN1, 2 =3.0V

Output 1 Characteristics			Step-up Controller			Ta=25°C	
PARAMETER	SYMBOL	CONDITIONS	MIN.	TYP.	MAX.	UNITS	TEST CIRCUIT
FB1 Voltage	VFB1	VDD=3.0V, VIN=1.5V, IOUT1=10mA	0.882	0.900	0.918	V	④
Operation Start-up Voltage1 (note 2)	VST1-1	Using Tr: 2SD1628, IOUT1=1.0mA, RFB11=200kΩ, RFB12=75kΩ	-	-	0.9	V	②
		VDD ≠ VOUT1: IOUT1=1mA	-	-	2.0	V	①
Oscillation Start-up Voltage1	VST2-1	FB1=0V	-	-	0.8	V	③
Maximum Duty Ratio1	MAXDTY1	Same as IDD1	75	80	85	%	③
Minimum Duty Ratio1	MINDTY1	Same as IDD2	-	-	0	%	③
PFM Duty Ratio1	PFMDTY1	No Load, VPWM1=0V	22	30	38	%	⑤
Efficiency1 (note 4)	EFF1	IOUT1=130mA N-ch MOSFET:XP161A1355P	-	85	-	%	⑤
Soft-Start Time1	TSS1	VOUT1 × 0.95V, EN1=0V → 0.65V	5.0	10.0	20.0	mS	⑤
EXT1 "High" ON Resistance	REXTBH1	FB1=0, EXT1=VDD-0.4V	-	28	47	Ω	⑥
EXT1 "Low" ON Resistance	REXTBL1	EN1=FB2=0V, EXT1=0.4V	-	22	30	Ω	⑥
PWM1 "High" Voltage	VPWMH1	No Load	0.65	-	-	V	⑤
PWM1 "Low" Voltage	VPWML1	No Load	-	-	0.20	V	⑤

Unless otherwise stated, VDD=EN1=PWM1=3.0V, EN2=PWM2=GND, EXT2=OPEN, FB2=OPEN, VIN=1.8V

Output 2 Characteristics			Step-down Controller			Ta=25°C	
PARAMETER	SYMBOL	CONDITIONS	MIN.	TYP.	MAX.	UNITS	TEST CIRCUIT
FB2 Voltage	VFB2	VIN=3.0V, IOUT2=10mA	0.900	0.900	0.900	V	⑦
Minimum Operation Voltage	VINmin		-	-	2.0	V	①
Maximum Duty Ratio2	MAXDTY2	Same as IDD1	100	-	-	%	③
Minimum Duty Ratio2	MINDTY2	Same as IDD2	-	-	0	%	③
PFM Duty Ratio2	PFMDTY2	No Load, VPWM2=0V	22	30	38	%	⑧
Efficiency2	EFFI2	IOUT2=250mA P-ch MOSFET : XP162A12A6P	-	92	-	%	⑧
Soft-Start Time2	TSS2	VOUT2 × 0.95V, EN2=0V → 0.65V	5.0	10.0	20.0	mS	⑥
EXT2 "High" ON Resistance	REXTBH2	EN2=0V, EXT2=VDD-0.4V	-	28	47	Ω	⑥
EXT2 "Low" ON Resistance	REXTBL2	FB2=0V, EXT2=0.4V	-	22	30	Ω	⑥
PWM2 "High" Voltage	VPWMH2	No Load	0.7	-	-	V	⑧
PWM2 "Low" Voltage	VPWML2	No Load	-	-	0.20	V	⑧

Unless otherwise stated, VDD=EN2=PWM2=3.0V, PWM1=EN1=GND, EXT1=OPEN, FB1=OPEN, VIN=5.0V

- Notes
- Although the IC's step-up operations start from a VDD of 0.8V, the output voltage and switching frequency are stabilized at VDD ≥ 2.0V. Therefore, a VDD of more than 2.0V is recommended when VDD is supplied from VIN or other power sources.
  - Although the IC's switching operations start from a VIN of 0.9V, the IC's power supply pin (VDD) and output voltage monitor pin (FB1) should be connected to VOUT1. With operations from VIN=0.9V, the 2nd channel's (output 2) EN2 pin should be set to chip disable. Once output voltage VOUT1 is more than 2.0V, the EN2 pin should be set to chip enable.
  - Please be careful not to exceed the breakdown voltage level of the peripheral parts.
  - $EFFI = \{ [(Output\ voltage) \times (Output\ current)] / [(Input\ voltage) \times (Input\ Current)] \} \times 100$

### Electrical Characteristics XC9502B095

Common Characteristics			(FOSC=500kHz)			Ta=25°C		
PARAMETER	SYMBOL	CONDITIONS	MIN.	TYP.	MAX.	UNITS	TEST CIRCUIT	
Supply Voltage (note 1)	VDD		2.0	-	10.0	V	①	
Max. Input Voltage	VIN		10.0	-	-	V	①	
Output Voltage Range (note 3)	VOUTSET	VDD ≥ 2.0V, IOU1, 2=1mA	VOUT1	0.9	-	-	V	①
		VDD=VOUT1	VOUT2	0.9	-	VIN	V	
		VIN ≥ 0.9V, IOU1, 2=1mA	VOUT1	2.0	-	10.0	V	②
		VDD=VOUT1	VOUT2	0.9	-	VIN	V	
Supply Current 1	IDD1	FB1, 2=0V	-	130	250	μA	③	
Supply Current 1-1	IDD1-1	EN1=3.0V, EN2=0V, FB1=0V	-	110	220	μA	③	
Supply Current 1-2	IDD1-2	EN2=3.0V, EN1=0V, FB2=0V	-	80	150	μA	③	
Supply Current 1-3	IDD1-3	FB1=0V, FB2=1.0V	-	130	240	μA	③	
Supply Current 1-4	IDD1-4	FB1=1.0V, FB2=0V	-	90	190	μA	③	
Supply Current 2	IDD2	FB1, 2=1.0V	-	90	190	μA	③	
Stand-by Current	ISTB	Same as IDD1, EN1=EN2=0V	-	1.0	3.0	μA	③	
Switching Frequency	FOSC	Same as IDD1	425	500	575	kHz	③	
EN1,2 "High" Voltage	VENH	FB1,2=0V	0.65	-	-	V	③	
EN1,2 "Low" Voltage	VENL	FB1,2=0V	-	-	0.20	V	③	
EN1,2 "High" Current	IENH	EN1,2=3.0V	-	-	0.50	μA	③	
EN1,2 "Low" Current	IENL	EN1,2=0V, FB1,2=3.0V	-	-	-0.50	μA	③	
PWM1,2 "High" Current	IPWMH	FB1, 2=3.0V, PWM=3.0V	-	-	0.50	μA	③	
PWM1,2 "Low" Current	IPWML	FB1, 2=3.0V, PWM=0V	-	-	-0.50	μA	③	
FB1,2 "High" Current	IFBH	FB1, 2=3.0V	-	-	0.50	μA	③	
FB1,2 "Low" Current	VFBL	FB1, 2=1.0V	-	-	-0.50	μA	③	

Unless otherwise stated, VDD=3.0V, PWM1,2=3.0V, EN1, 2 =3.0V

Output 1 Characteristics			Step-up Controller			Ta=25°C	
PARAMETER	SYMBOL	CONDITIONS	MIN.	TYP.	MAX.	UNITS	TEST CIRCUIT
FB1 Voltage	VFB1	VDD=3.0V, VIN=1.5V, IOU1=10mA	0.882	0.900	0.918	V	④
Operation Start-up Voltage1 (note 2)	VST1-1	Using Tr: 2SD1628, IOU1=1.0mA, RFB11=200kΩ, RFB12=75kΩ	-	-	0.9	V	②
		VDD ≠ VOUT1: IOU1=1mA	-	-	2.0	V	①
Oscillation Start-up Voltage1	VST2-1	FB1=0V	-	-	0.8	V	③
Maximum Duty Ratio1	MAXDTY1	Same as IDD1	75	80	85	%	③
Minimum Duty Ratio1	MINDTY1	Same as IDD2	-	-	0	%	③
PFM Duty Ratio1	PFMDTY1	No Load, VPWM1=0V	22	30	38	%	⑤
Efficiency1 (note 4)	EFF1	IOU1=130mA	-	83	-	%	⑤
		N-ch MOSFET:XP161A1355P	-	-	-	%	
Soft-Start Time1	TSS1	VOUT1 × 0.95V, EN1=0V → 0.65V	5.0	10.0	20.0	mS	⑤
EXT1 "High" ON Resistance	REXTBH1	FB1=0, EXT1=VDD-0.4V	-	28	47	Ω	⑥
EXT1 "Low" ON Resistance	REXTBL1	EN1=FB2=0V, EXT1=0.4V	-	22	30	Ω	⑥
PWM1 "High" Voltage	VPWMH1	No Load	0.65	-	-	V	⑤
PWM1 "Low" Voltage	VPWML1	No Load	-	-	0.20	V	⑤

Unless otherwise stated, VDD=EN1=PWM1=3.0V, EN2=PWM2=GND, EXT2=OPEN, FB2=OPEN, VIN=1.8V

Output 2 Characteristics			Step-down Controller			Ta=25°C	
PARAMETER	SYMBOL	CONDITIONS	MIN.	TYP.	MAX.	UNITS	TEST CIRCUIT
FB2 Voltage	VFB2	VIN=3.0V, IOU2=10mA	0.882	0.900	0.918	V	⑦
Minimum Operation Voltage	VINmin		-	-	2.0	V	①
Maximum Duty Ratio2	MAXDTY2	Same as IDD1	100	-	-	%	③
Minimum Duty Ratio2	MINDTY2	Same as IDD2	-	-	0	%	③
PFM Duty Ratio2	PFMDTY2	No Load, VPWM2=0V	22	30	38	%	⑥
Efficiency2	EFF2	IOU2=250mA	-	91	-	%	⑧
		P-ch MOSFET : XP162A12A6P	-	-	-	%	
Soft-Start Time2	TSS2	VOUT2 × 0.95V, EN2=0V → 0.65V	5.0	10.0	20.0	mS	⑧
EXT2 "High" ON Resistance	REXTBH2	EN2=0, EXT2=VDD-0.4V	-	28	47	Ω	⑥
EXT2 "Low" ON Resistance	REXTBL2	FB2=0V, EXT2=0.4V	-	22	30	Ω	⑥
PWM2 "High" Voltage	VPWMH2	No Load	0.65	-	-	V	⑧
PWM2 "Low" Voltage	VPWML2	No Load	-	-	0.20	V	⑧

Unless otherwise stated, VDD=EN2=PWM2=3.0V, PWM1=EN1=GND, EXT1=OPEN, FB1=OPEN, VIN=5.0V

- Notes
- Although the IC's step-up operations start from a VDD of 0.8V, the output voltage and switching frequency are stabilized at VDD ≥ 2.0V. Therefore, a VDD of more than 2.0V is recommended when VDD is supplied from VIN or other power sources.
  - Although the IC's switching operations start from a VIN of 0.9V, the IC's power supply pin (VDD) and output voltage monitor pin (FB1) should be connected to VOUT1. With operations from VIN=0.9V, the 2nd channel's (output 2) EN2 pin should be set to chip disable. Once output voltage VOUT1 is more than 2.0V, the EN2 pin should be set to chip enable.
  - Please be careful not to exceed the breakdown voltage level of the peripheral parts.
  - $EFFI = \left\{ \left[ \frac{\text{Output voltage} \times \text{Output current}}{\text{Input voltage} \times \text{Input Current}} \right] \right\} \times 100$

## ■ Operational Description

The XC9502 series are multi-functional, 2 channel step-up and down DC/DC converter controller ICs with built-in high speed, low ON resistance drivers.

### <Error Amp>

The Error Amplifier is designed to monitor the output voltage and it compares the feedback voltage (FB) with the reference voltage. In response to feedback of a voltage lower than the reference voltage, the output voltage of the error amp. decreases.

### <OSC Generator>

This circuit generates the Switching Frequency which in turn generates the reference clock.

### <Ramp Wave Generator 1, 2>

The Ramp Wave Generator generates a saw-tooth waveform based on outputs from the Phase Shift Generator.

### <PWM Comparator 1, 2>

The PWM Comparator compares outputs from the Error Amp. and saw-tooth waveform. When the voltage from the Error Amp's output is low, the external switch will be set to ON.

### <PWM/PFM Controller 1, 2>

This circuit generates PFM pulses.

Control can be switched between PWM control and PWM/PFM automatic switching control using external signals.

The PWM/PFM automatic switching mode is selected when the voltage of the PWM1 (2) pin is less than 0.2V, and the control switches between PWM and PFM automatically depending on the load. As the PFM circuit generates pulses based on outputs from the PWM comparator, shifting between modes occurs smoothly. PWM control mode is selected when the voltage of the PWM1 (2) pin is more than 0.65V. Noise is easily reduced with PWM control since the switching frequency is fixed.

Control suited to the application can easily be selected which is useful in audio applications, for example, where traditionally, efficiencies have been sacrificed during stand-by as a result of using PWM control (due to the noise problems associated with the PFM mode in stand-by).

### <Vref with Soft Start 1, 2>

The reference voltage, Vref (FB pin voltage)=0.9V, is adjusted and fixed by laser trimming (for output voltage settings, please refer to the notes on page 8). To protect against inrush current, when the power is switched on, and also to protect against voltage overshoot, soft-start time is set internally to 10ms. It should be noted, however, that this circuit does not protect the load capacitor (CL) from inrush current. With the Vref voltage limited and depending upon the input to the error amps, the operation maintains a balance between the two inputs of the error amps and controls the EXT pin's ON time so that it doesn't increase more than is necessary.

### <Chip Enable Function>

This function controls the operation and shutdown of the IC. When the voltage of the EN1 or EN2 pins is 0.2V or less, the mode will be chip disable, the channel's operations will stop and the EXT1 pin will be kept at a low level (the external N-type MOSFET will be OFF) and the EXT2 pin will be kept at a high level (the external P-type MOSFET will be OFF). When both EN1 and EN2 are in a state of chip disable, current consumption will be no more than 3.0  $\mu$ A.

When the EN1 or EN2 pin's voltage is 0.65V or more, the mode will be chip enable and operations will recommence. With soft-start, 95% of the set output voltage will be reached within 10mS (TYP) from the moment of chip enable.

Although IC starts oscillation from a VIN of 0.9V, the IC's power supply pin (VDD) and the output voltage monitor pin (FB1) should be connected to VOUT1. The start-up sequence for EN1 and EN2 is required when operations begin with a power supply voltage of VDD=0.9V, and channel two's (output 2) EN2 pin should be set to chip disable and turn it to enable when VOUT1 is more than 2.0V.

For power supply voltages of VDD<2.0V, oscillation may occur irrespective of the FB pin voltage. Should this happen, you may find that output voltage will be higher than the set voltage. The FB pin voltage and the reference voltage Vref will be compared and output voltage will be controlled when the power supply voltage is VDD>2.0V or more. With power supply voltages of VDD>2.0V, the start-up sequence for EN1 and EN2 will not be required.

### <Setting of Output Voltage>

Output voltage can be set by adding external split resistors. Output voltage is determined by the following equation, based on the values of RFB11(RFB21) and RFB12(RFB22). The sum of RFB11(RFB21) and RFB12(RFB22) should normally be 1 MΩ or less.

$$V_{OUT} = 0.9 \times (R_{FB11} + R_{FB12}) / R_{FB12}$$

The value of CFB1(CFB2), speed-up capacitor for phase compensation, should be  $f_{zfb} = 1 / (2 \times \pi \times C_{FB1} \times R_{FB11})$  which is equal to 12kHz. Adjustments are required from 1kHz to 50kHz depending on the application, value of inductance (L), and value of load capacity (CL).

### [Example of Calculation]

When RFB11=200kΩ and RFB12=75kΩ,  $V_{OUT1} = 0.9 \times (200K + 75k) / 75k = 3.3V$ .

### [Typical Example]

VOUT (V)	RFB11 (kΩ)	RFB12 (kΩ)	CFB1 (pF)	VOUT (V)	RFB11 (kΩ)	RFB12 (kΩ)	CFB1 (pF)	VOUT (V)	RFB11 (kΩ)	RFB12 (kΩ)	CFB1 (pF)
1.0	30	270	430	2.5	390	220	33	8.0	120	15	100
1.5	220	330	62	2.7	360	180	33	12.0	160	13	82
1.8	220	220	62	3.0	560	240	24				
2.0	330	270	39	3.3	200	75	62				
2.2	390	270	33	5.0	82	18	160				

The same method can be adopted for channel two (output 2) also.

### [External Components]

#### Output 1 (Step-up DC/DC controller)

Tr 1 : \* MOSFET

XP161A1355PR (TOREX N-Channel Power MOSFET)

Note : VGS Breakdown Voltage of this Tr. is 8V so please be careful with the power supply voltage. For 6V power supply voltage, XP161A1265PR which VGS breakdown voltage is 12V is recommended.

VST1 of XP161A1355PR is 1.2V (max.) and that of XP161A1265PR is 1.5V (max.)

SD 1 : MA2Q737 (Schottky, MATSUSHITA)  
CMS02 (Schottky, TOSHIBA)

L 1 : 10μH (SUMIDA, CDRH5D28, FOSC = 500kHz)  
15μH (SUMIDA, CDRH5D28, FOSC = 300kHz)  
22μH (SUMIDA, CDRH5D28, FOSC = 180kHz)

CL1 : 16V, 47μF (Tantalum)  
Increase capacity according to the equation below when the step-up voltage ratio is large and output current is high.

$$C = (CL \text{ standard value}) \times (I_{OUT1}(\text{mA}) / 300\text{mA}) \times V_{OUT1} / V_{IN}$$

Tr : \* NPN MOSFET  
2SD1628 (SANYO)

RB 1 : 500Ω (Adjust in accordance with load & Tr.'s HFE.)  
Set according to the equation below.  
 $RB1 \leq (V_{IN} - 0.7) \times h_{FE} / I_{C-REXTBH}$

CB1 : 2200pF (Ceramic)  
Set according to the equation below.  
 $CB1 \leq (2 \pi \times RB2 \times FOSC \times 0.7)$

#### Output 2 (Step-down DC/DC controller)

Tr 2 : \* MOSFET

XP162A12A6P (TOREX P-Channel Power MOSFET)

Note : VGS Breakdown Voltage of this Tr. is 12V so please be careful with the power supply voltage.

SD 2 : MA2Q737 (Schottky, MATSUSHITA)  
CMS02 (Schottky, TOSHIBA)

L 2 : 10μH (SUMIDA, CDRH5D28, FOSC = 500kHz)  
22μH (SUMIDA, CDRH5D28, FOSC = 300kHz)  
47μH (SUMIDA, CDRH5D28, FOSC = 180kHz)

CL2 : 16V, 47μF (Tantalum)  
Increase capacity according to the equation below when the step-up voltage ratio is large and output current is high.

$$C = (CL \text{ standard value}) \times (I_{OUT2}(\text{mA}) / 500\text{mA}) \times V_{OUT2} / V_{IN}$$

Tr : \* PNP MOSFET  
2SA1213 (SANYO)

RB 2 : 500Ω (Adjust in accordance with load & Tr.'s HFE.)  
Set according to the equation below.  
 $RB2 \leq (V_{IN} - 0.7) \times h_{FE} / I_{C-REXTBH}$

CB1 : 2200pF (Ceramic)  
Set according to the equation below.  
 $CB2 \leq (2 \pi \times RB2 \times FOSC \times 0.7)$



### ■ Test Circuits

Circuit 1

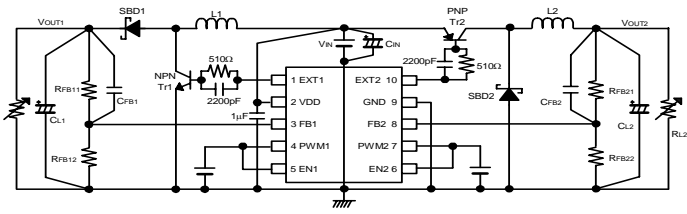

Circuit 5

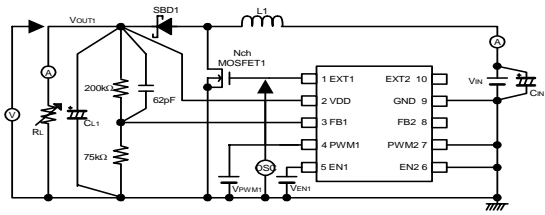

Circuit 2

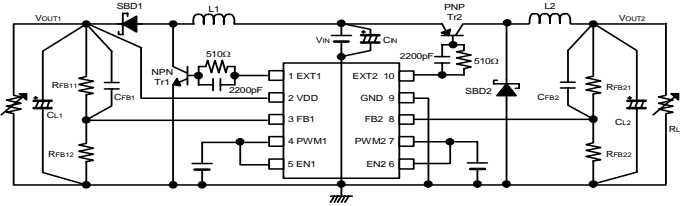

Circuit 6

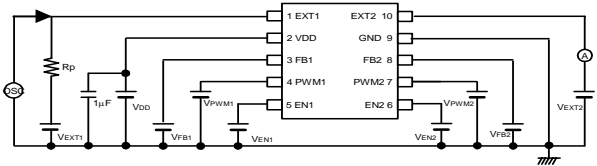

Circuit 3

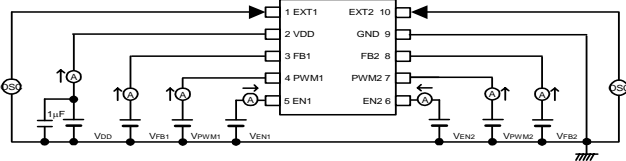

Circuit 7

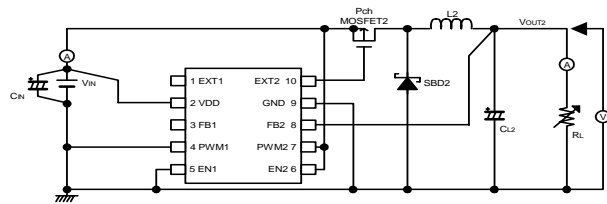

Circuit 4

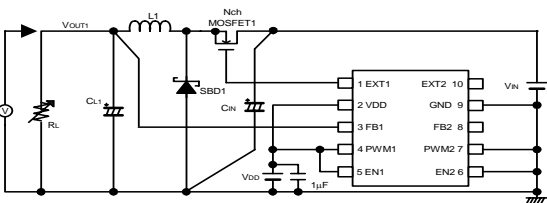

Circuit 8

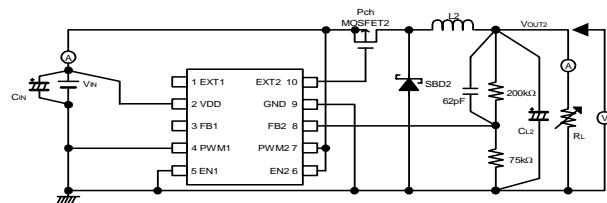

## ■ Peripheral Components Used for Test Circuits

### Circuits 1, 2

L1, L2 :	22 $\mu$ H (SUMIDA CDRH5D28) : XC9502B092A
	15 $\mu$ H (SUMIDA CDRH5D28) : XC9502B093A
	10 $\mu$ H (SUMIDA CDRH5D28) : XC9502B095A
SD1, SD2 :	CRS02 (Schottky diode, TOSHIBA)
	EC10QS06 (Schottky diode, NIHON INTER)
CL1, CL2 :	16MCE476MD2 (Tantalum, NIHON CHEMICON)
	35MCE335MB2 x 3 (Tantalum, NIHON CHEMICON)
CIN :	16MCE476MD2 (Tantalum, NIHON CHEMICON)
NPN Tr1 :	2SD1628 (SANYO)
PNP Tr1 :	2SA1213 (TOSHIBA)
RFB :	Please use by the conditions as below.
	$RFB11 + RFB12 \leq 1M\Omega$
	$RFB21 + RFB22 \leq 1M\Omega$
	$RFB11 / RFB12 = (\text{Setting Output Voltage} / 0.9) - 1$
	$VOUT2 = (0.9 - VOUT1) \times (RFB21 / RFB22) + 0.9V$
CFB :	Please adjust as below:
	$fzfb = 1 / (2 \times \pi \times CFB1 \times RFB11) = 1\text{kHz} \sim 50\text{kHz}$ ( 12kHz usual)
	$fzfb = 1 / (2 \times \pi \times CFB2 \times RFB21) = 1\text{kHz} \sim 50\text{kHz}$ ( 12kHz usual)

### Circuits 4

L1 :	22 $\mu$ H (SUMIDA CDRH5D28)
SD1 :	MA2Q737 (Schottky diode, MATSUSHITA)
CL1 :	16MCE476MD2 (Tantalum, NIHON CHEMICON)
CIN :	16MCE476MD2 (Tantalum, NIHON CHEMICON)
N-ch MOSFET1 :	XP161A1355P (TOREX)

### Circuits 5

L1 :	22 $\mu$ H (SUMIDA CDRH5D28) : XC9502B092A
	15 $\mu$ H (SUMIDA CDRH5D28) : XC9502B093A
	10 $\mu$ H (SUMIDA CDRH5D28) : XC9502B095A
SD1 :	MA2Q737 (Schottky, MATSUSHITA)
CL1 :	16MCE476MD2 (Tantalum, NIHON CHEMICON)
CIN :	16MCE476MD2 (Tantalum, NIHON CHEMICON)
N-ch MOSFET1 :	XP161A1355P (TOREX)

### Circuit 7

L1 :	22 $\mu$ H (SUMIDA CDRH5D28)
SD1 :	MA2Q737 (Schottky diode, MATSUSHITA)
CL1 :	16MCE476MD2 (Tantalum, NIHON CHEMICON)
CIN :	16MCE476MD2 (Tantalum, NIHON CHEMICON)
P-ch MOSFET1 :	XP162A12A6P (TOREX)

### Circuit 8

L2 :	22 $\mu$ H (SUMIDA CDRH5D28) : XC9502B092A
	15 $\mu$ H (SUMIDA CDRH5D28) : XC9502B093A
	10 $\mu$ H (SUMIDA CDRH5D28) : XC9502B095A
SD2 :	MA2Q737 (Schottky, MATSUSHITA)
CL2 :	16MCE476MD2 (Tantalum, NIHON CHEMICON)
CIN :	16MCE476MD2 (Tantalum, NIHON CHEMICON)
P-ch MOSFET1 :	XP161A12A6P (TOREX)

## ■ NoteS on Use

### 1. Checking for Intermittent Oscillation

The XC9502 series is subject to intermittent oscillation in the proximity of the maximum duty if the step-down ratio is low (e.g., from 4.2 V to 3.3 V) or a heavy load is applied where the duty ratio becomes high. Check waveforms at EXT under your operating conditions. A remedy for this problem is to raise the inductance of coil L or increase the load capacitance CL.

### 2. PWM/PFM Automatic Switching

If PWM/PFM automatic switching control is selected and the step-up ration is low (e.g., from 4.5V to 5.0V) or the step-down ratio is high (e.g., from 10.0V to 1.0 V), the control mode remains in PFM setting in the whole load range, since the duty ratio under continuous-duty condition is smaller than the PFM duty ratio of the XC9502 series. The output voltage's ripple voltage becomes substantially high under heavy load conditions, with the XC9502 series appearing to be producing an abnormal oscillation. If this operation becomes a concern, set pins PWM1 and PWM2 to High to set the control mode to PWM setting. For use under the above-mentioned condition, measured data of PWM/PFM automatic switching control shown on the data sheets are available up to IOU<sub>T</sub> = 100 mA.

### 3. Ratings

Use the XC9502 series and peripheral components within the limits of their ratings.

### ■ Typical Performance Characteristics

#### < 1ch Step-up DC/DC Controller >

##### (1) Output Voltage vs. Output Current

**FOSC=180kHz, V<sub>OUT1</sub>= 1.5V**

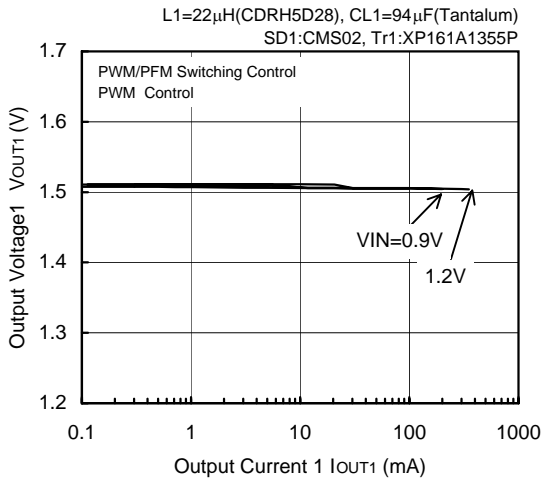

**FOSC=180kHz, V<sub>OUT1</sub>= 2.5V**

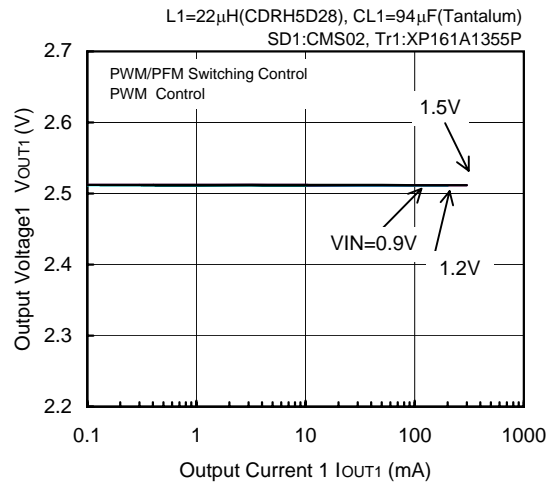

**FOSC=180kHz, V<sub>OUT1</sub>= 3.3V**

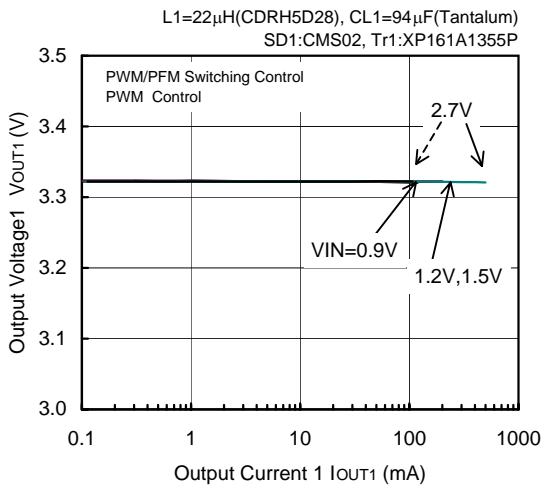

**FOSC=180kHz, V<sub>OUT1</sub>= 5.0V**

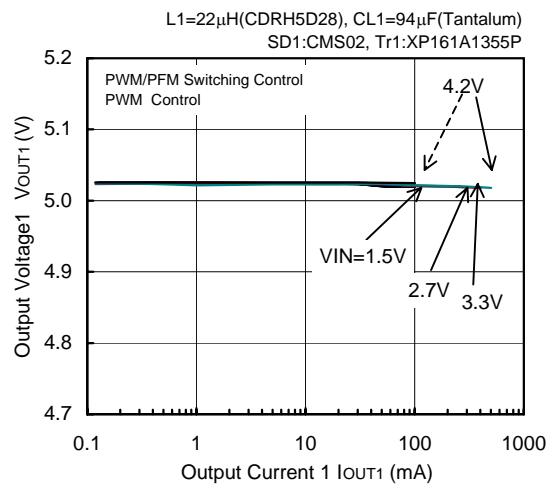

**FOSC=180kHz, V<sub>OUT1</sub>= 8.0V**

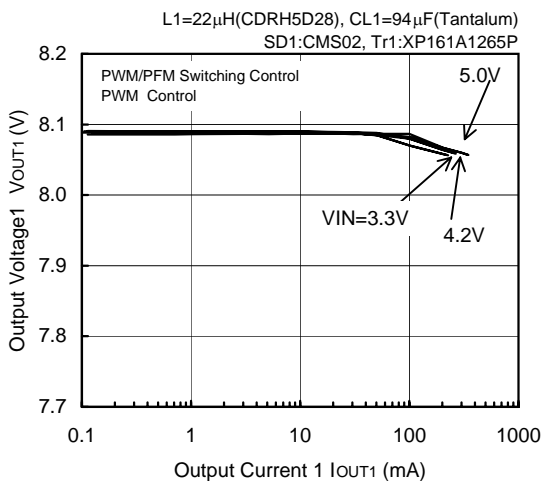

Dotted Arrowhead ----> PWM/PFM Switching Control

### < 1ch Step-up DC/DC Controller >

(1) Output Voltage vs. Output Current (Continued)

**FOSC=300kHz, V<sub>OUT1</sub>= 2.5V**

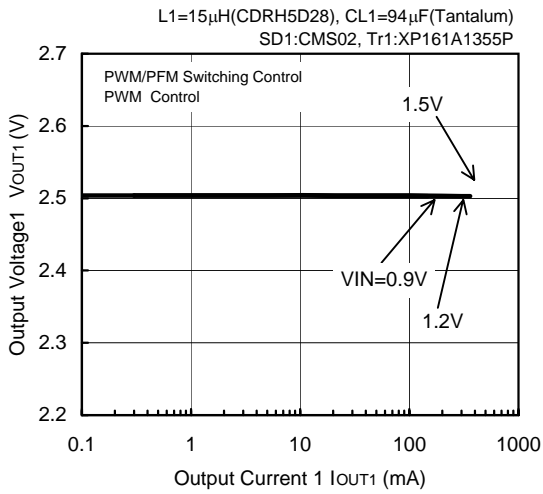

**FOSC=300kHz, V<sub>OUT1</sub>= 3.3V**

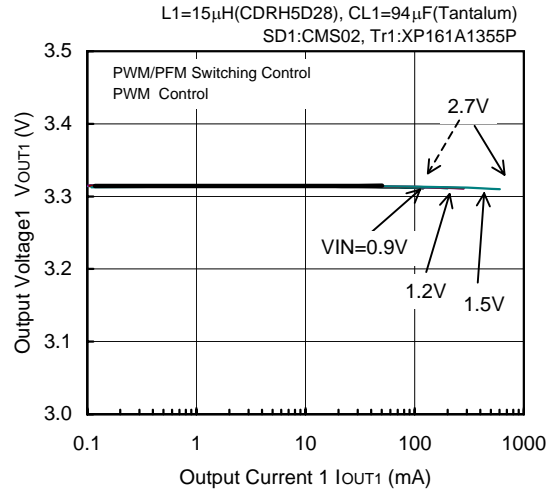

**FOSC=300kHz, V<sub>OUT1</sub>= 5.0V**

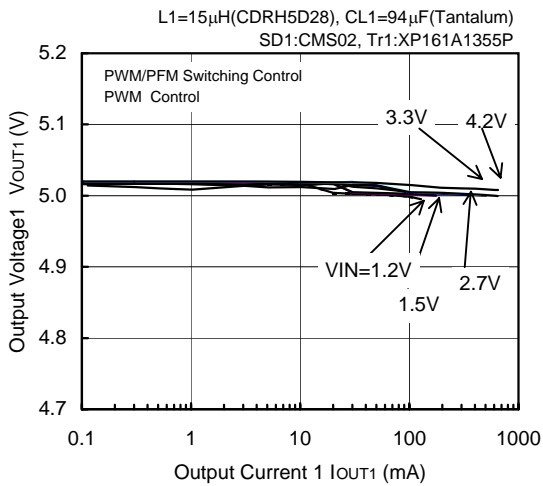

**FOSC=500kHz, V<sub>OUT1</sub>= 2.5V**

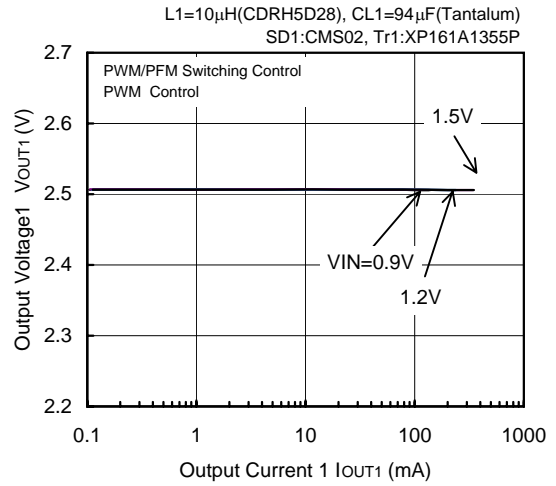

**FOSC=500kHz, V<sub>OUT1</sub>= 3.3V**

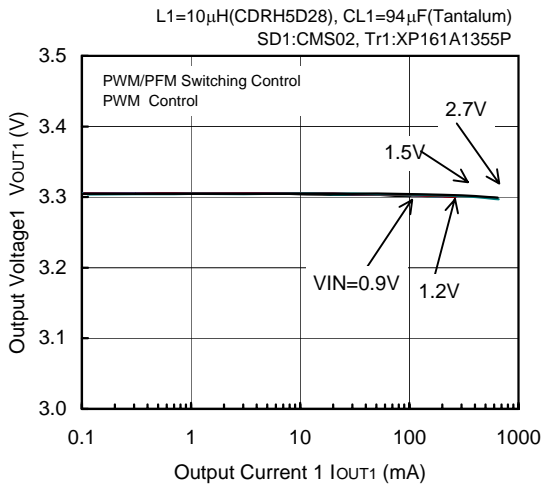

**FOSC=500kHz, V<sub>OUT1</sub>= 5.0V**

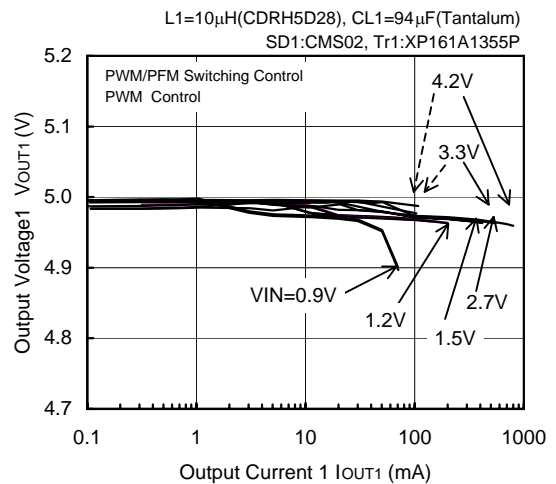

Dotted Arrowhead ----> PWM/PFM Switching Control

< 1ch Step-up DC/DC Controller >  
(2) Efficiency vs. Output Current

**FOSC=180kHz, VOUT1= 1.5V**

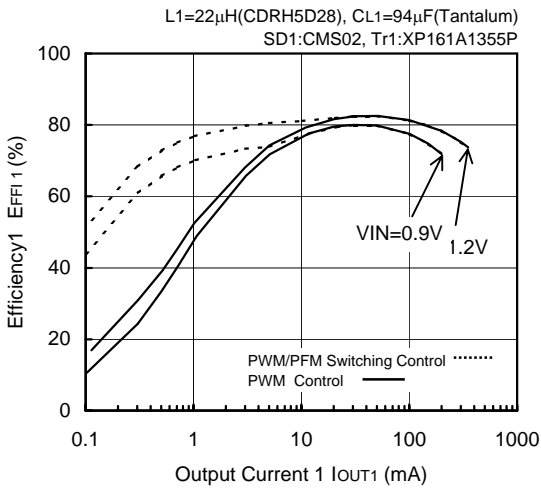

**FOSC=180kHz, VOUT1= 2.5V**

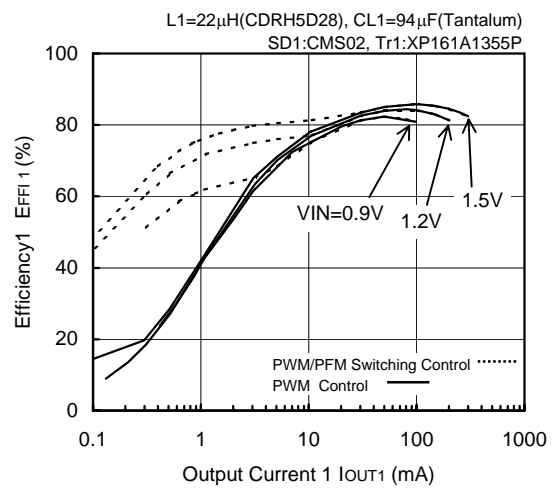

**FOSC=180kHz, VOUT1= 3.3V**

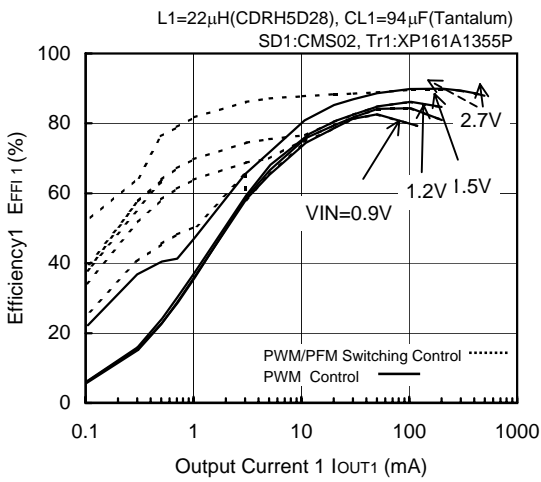

**FOSC=180kHz, VOUT1= 5.0V**

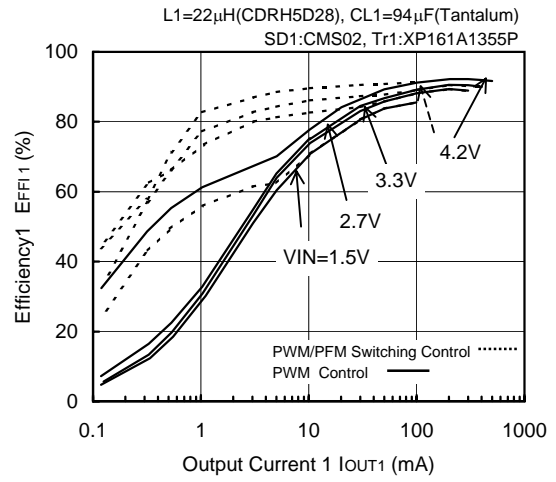

**FOSC=180kHz, VOUT1= 8.0V**

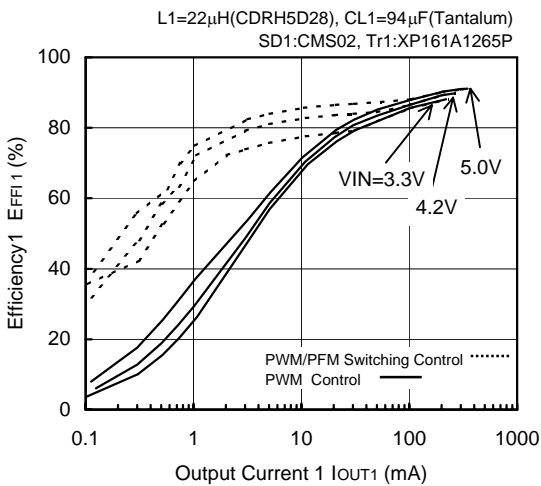

Dotted Arrowhead ----> PWM/PFM Switching Control

### < 1ch Step-up DC/DC Controller >

#### (2) Efficiency vs. Output Current (Continued)

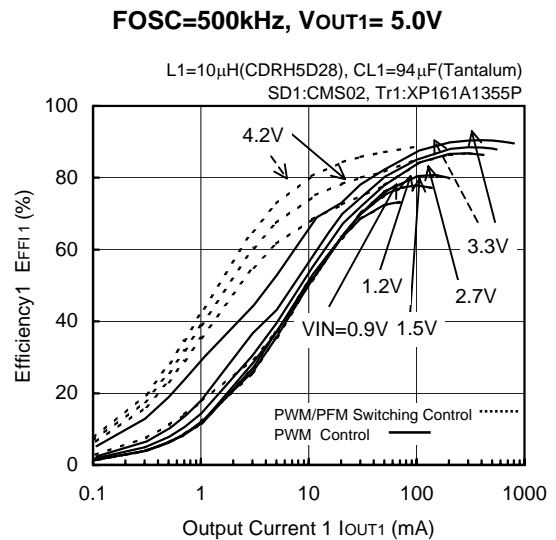
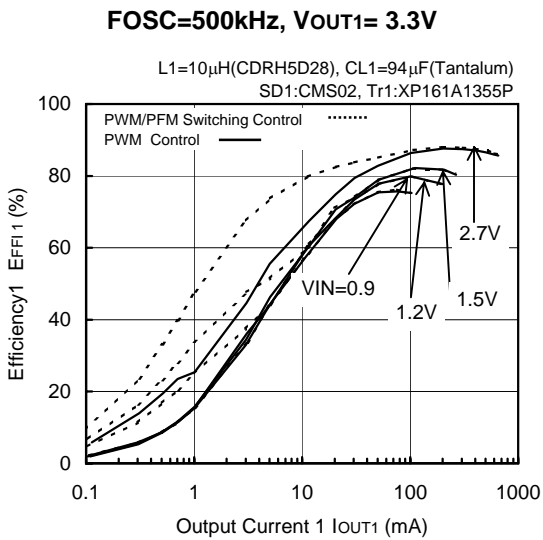
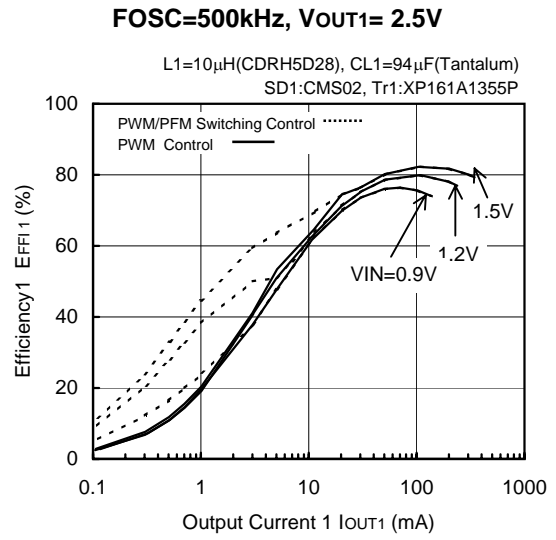
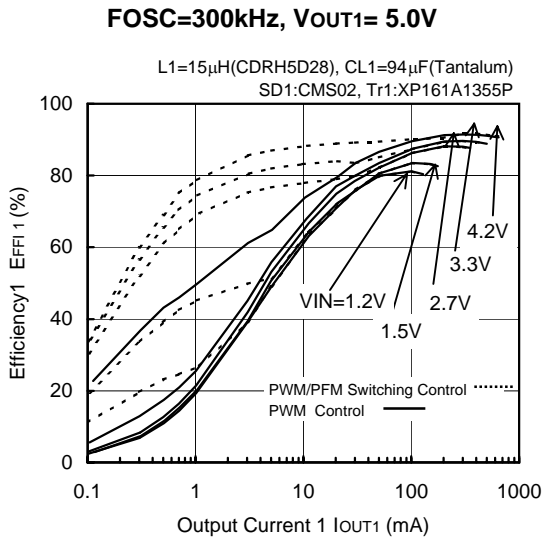
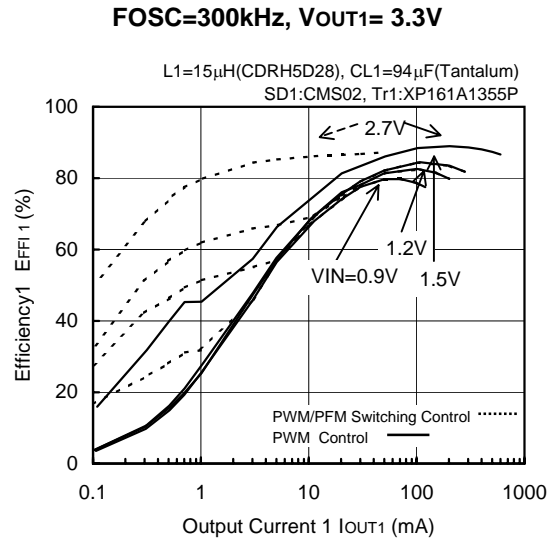
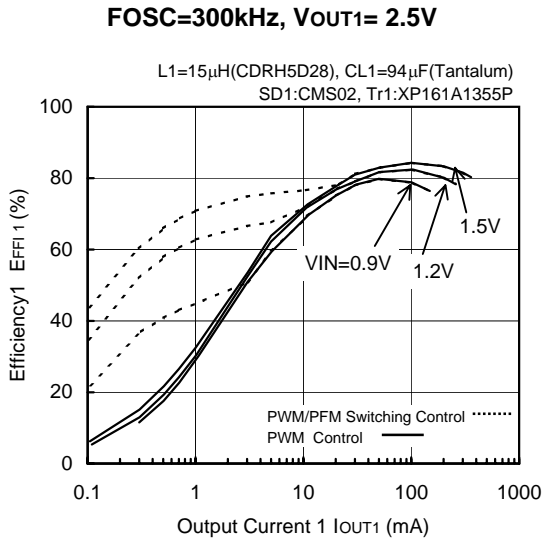

Dotted Arrowhead ----> PWM/PFM Switching Control

### < 1ch Step-up DC/DC Controller >

#### (3) Ripple Voltage vs. Output Current

**FOSC=180kHz, V<sub>OUT1</sub>= 1.5V**

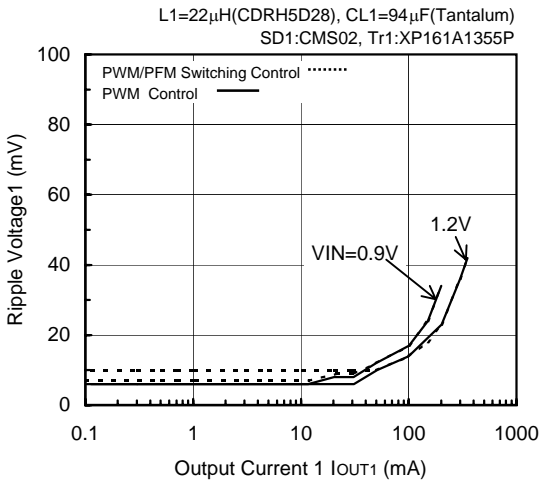

**FOSC=180kHz, V<sub>OUT1</sub>= 2.5V**

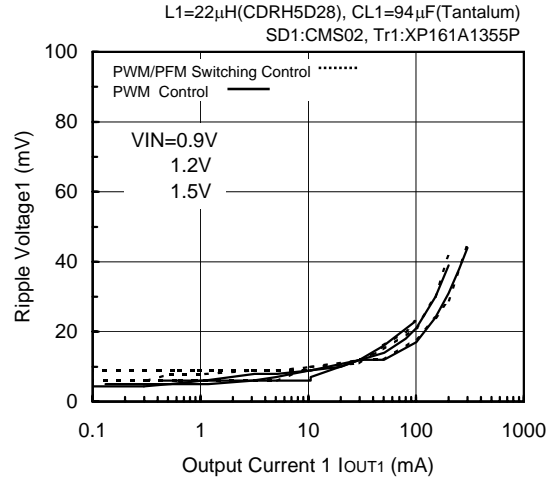

**FOSC=180kHz, V<sub>OUT1</sub>= 3.3V**

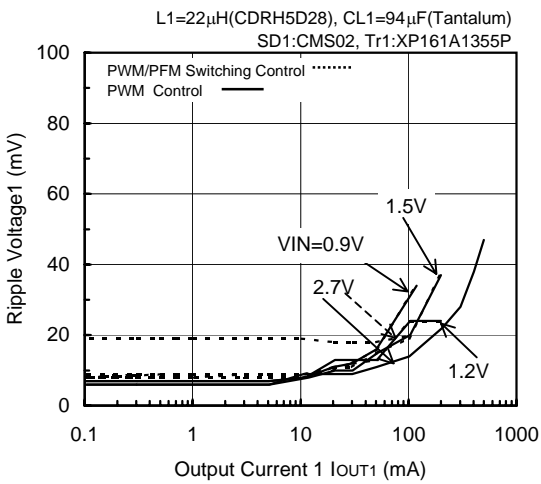

**FOSC=180kHz, V<sub>OUT1</sub>= 5.0V**

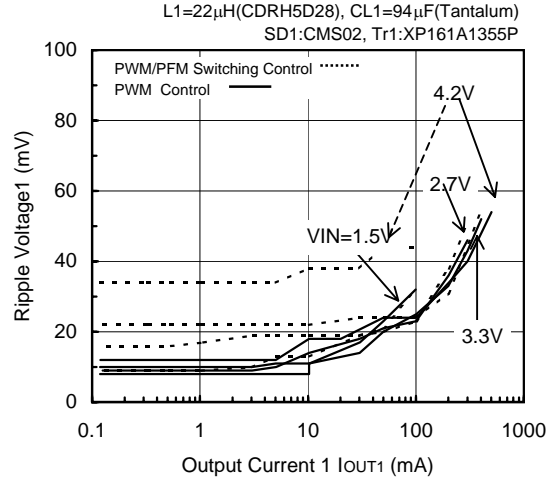

**FOSC=180kHz, V<sub>OUT1</sub>= 8.0V**

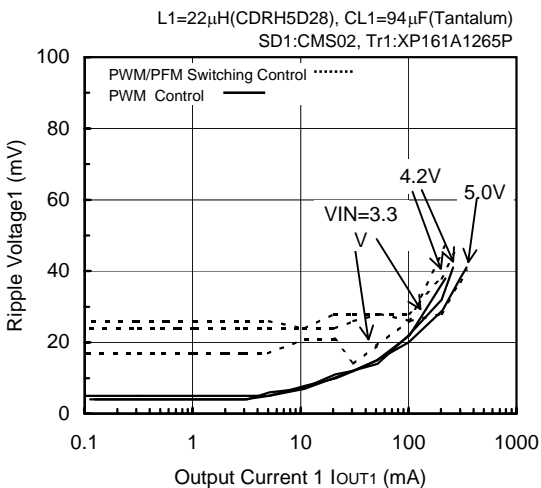

Dotted Arrowhead ----> PWM/PFM Switching Control



**< 1ch Step-up DC/DC Controller >**

(3) Ripple Voltage vs. Output Current (Continued)

**FOSC=300kHz, VOUT1= 2.5V**

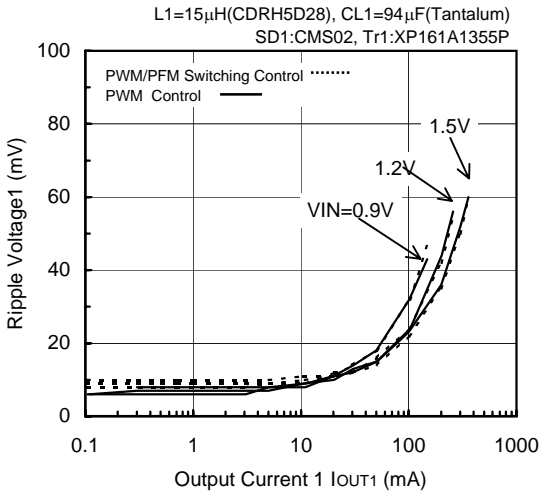

**FOSC=300kHz, VOUT1= 3.3V**

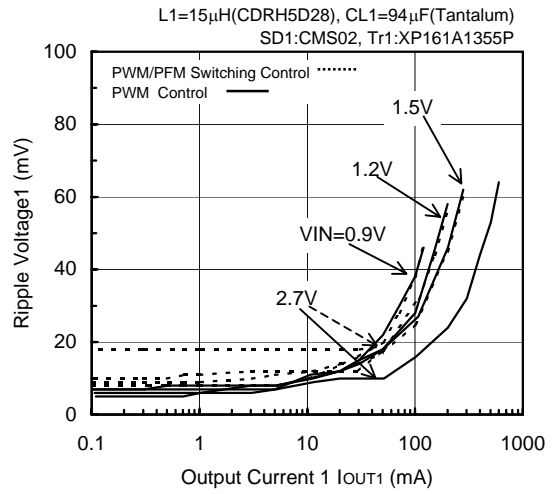

**FOSC=300kHz, VOUT1= 5.0V**

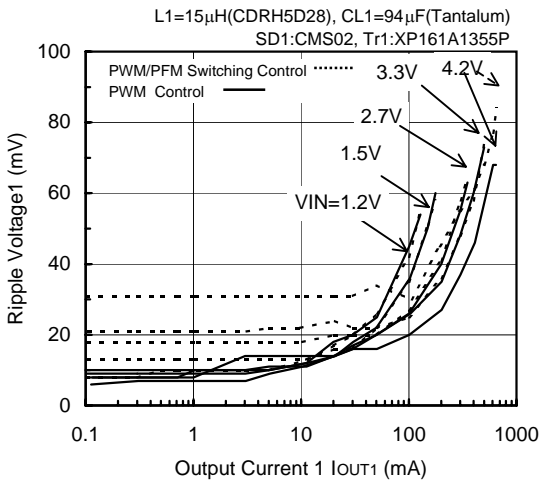

**FOSC=500kHz, VOUT1= 2.5V**

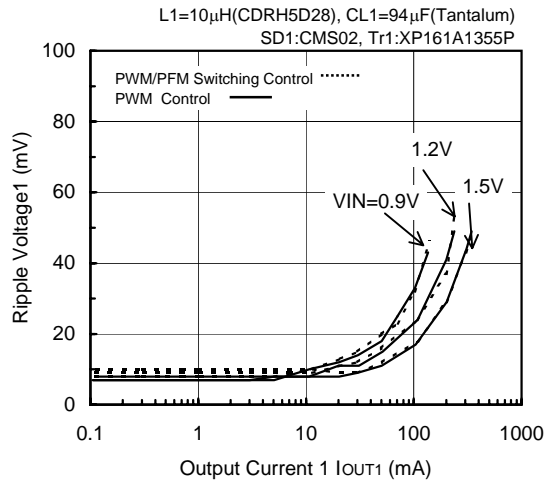

**FOSC=500kHz, VOUT1= 3.3V**

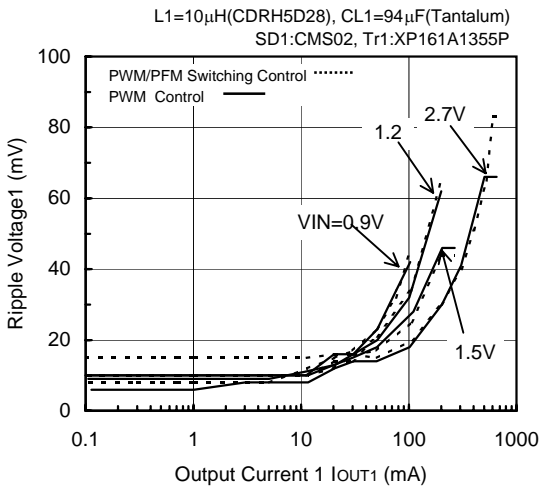

**FOSC=500kHz, VOUT1= 5.0V**

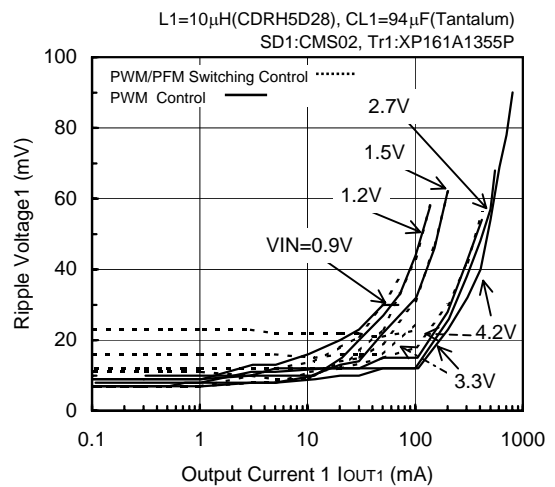

Dotted Arrowhead ----> PWM/PFM Switching Control

### < 2ch Step-down DC/DC Controller >

#### (4) Output Voltage vs. Output Current

**FOSC=180kHz, VOUT2=1.0V**

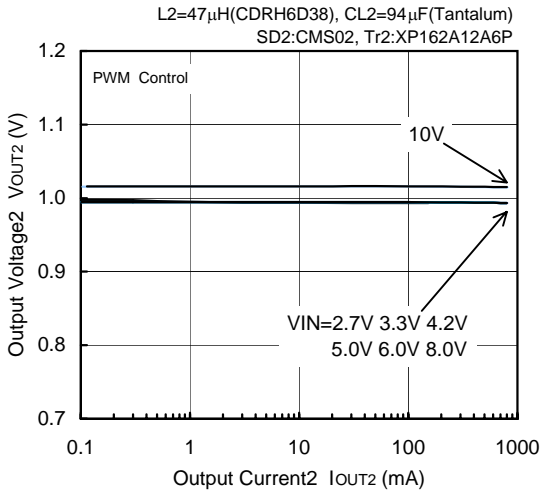

**FOSC=180kHz, VOUT2=1.0V**

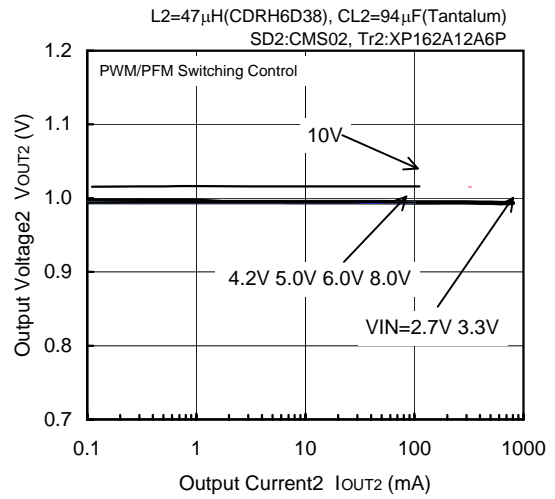

**FOSC=180kHz, VOUT2=3.3V**

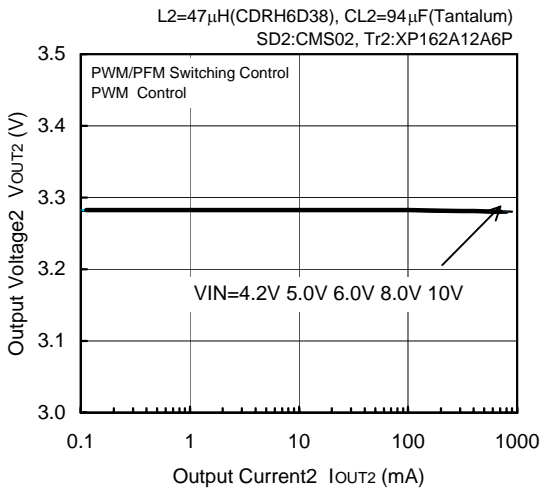

**FOSC=180kHz, VOUT2=5.0V**

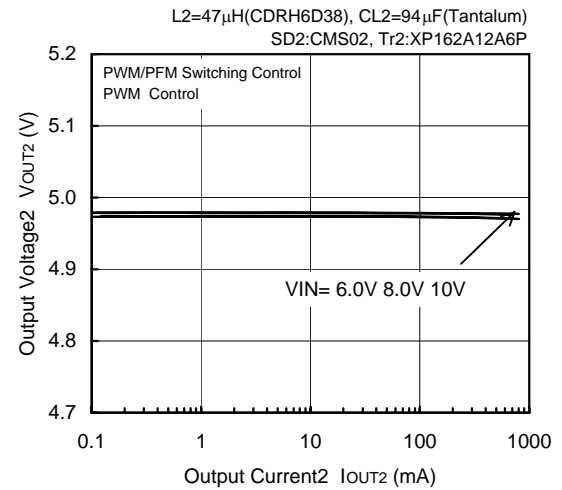

**FOSC=300kHz, VOUT2=1.0V**

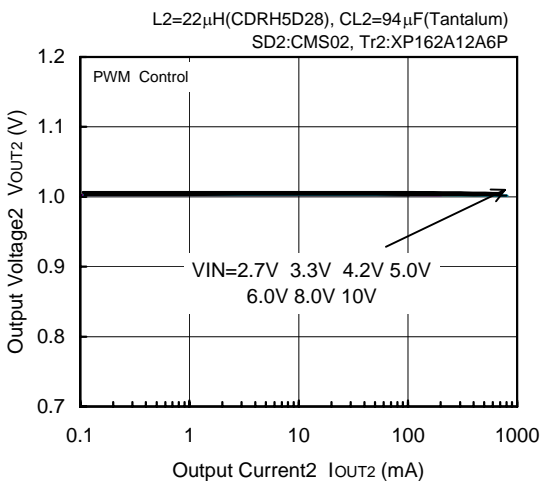

**FOSC=300kHz, VOUT2=1.0V**

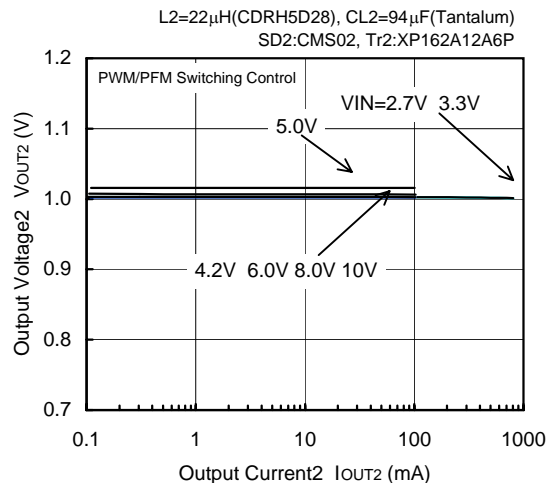

\* When setting VOUT = 1.0V, VIN = 8.0V, 10.0V  
CL should be 94 $\mu$ F (Tantalum) + 100 $\mu$ F (OS capacitor)

**< 2ch Step-down DC/DC Controller >**

**(4) Output Voltage vs. Output Current (Continued)**

**FOSC=300kHz, VOUT2=1.8V**

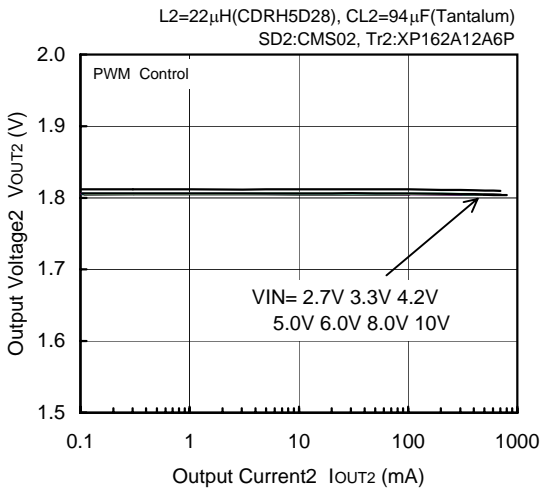

**FOSC=300kHz, VOUT2=1.8V**

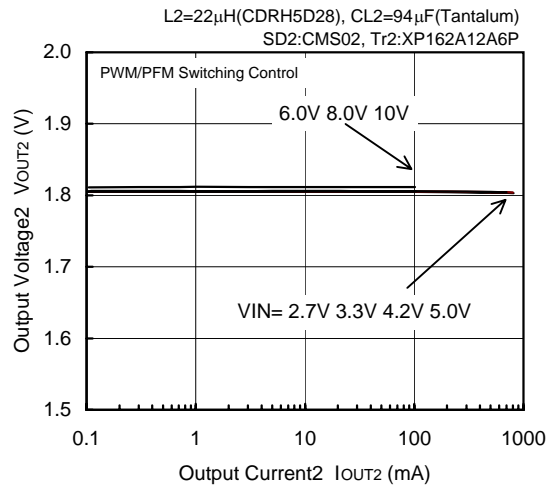

**FOSC=300kHz, VOUT2=2.5V**

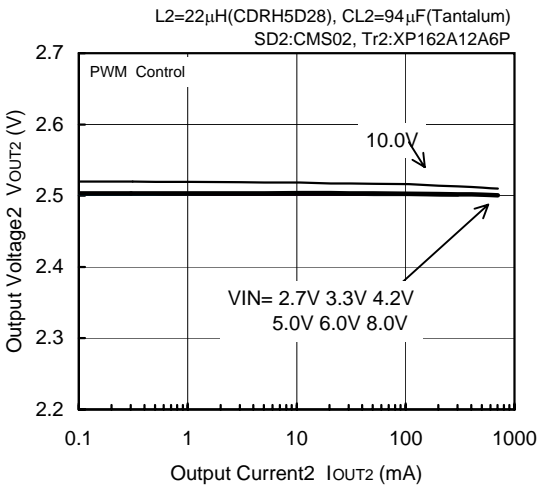

**FOSC=300kHz, VOUT2=2.5V**

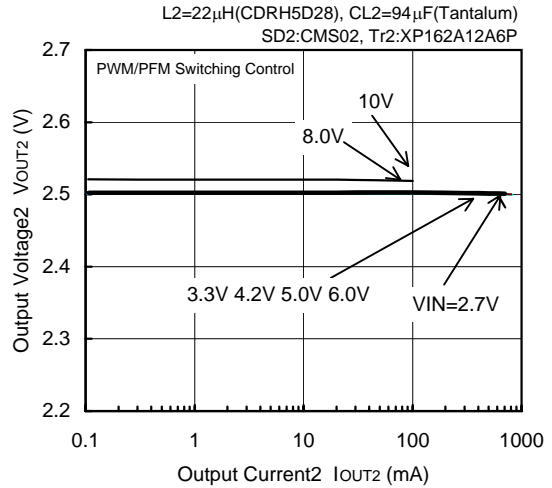

L2=22 $\mu$ H(CDRH5D28), CL2=94 $\mu$ F(Tantalum)  
SD2:CMS02, Tr2:XP162A12A6P

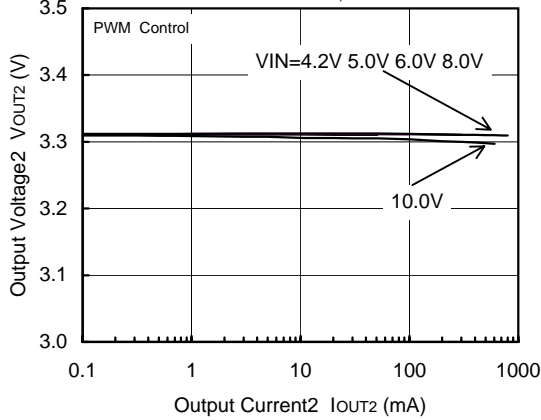

**FOSC=300kHz, VOUT2=3.3V**

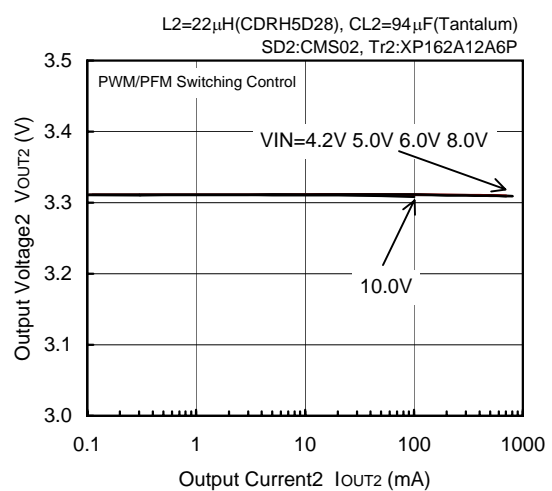

\* When setting VOUT = 1.0V, VIN = 8.0V, 10.0V  
CL should be 94 $\mu$ F (Tantalum) + 100 $\mu$ F (OS capacitor)

### < 2ch Step-down DC/DC Controller >

#### (4) Output Voltage vs. Output Current (Continued)

**FOSC=300kHz, VOUT2=5.0V**

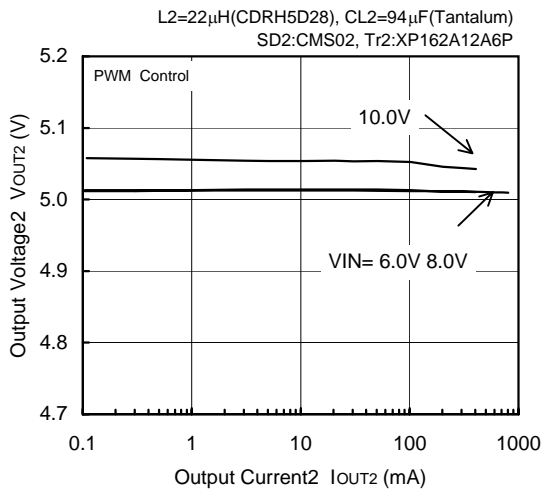

**FOSC=300kHz, VOUT2=5.0V**

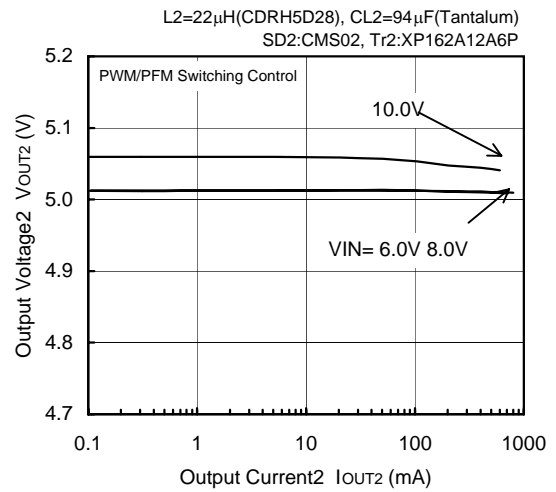

**FOSC=500kHz, VOUT2=1.0V**

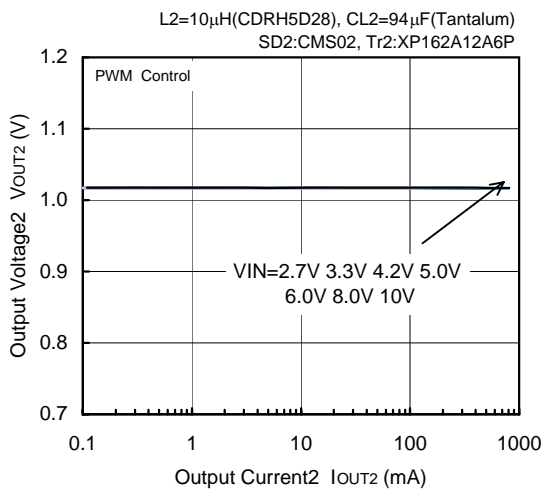

**FOSC=500kHz, VOUT2=1.0V**

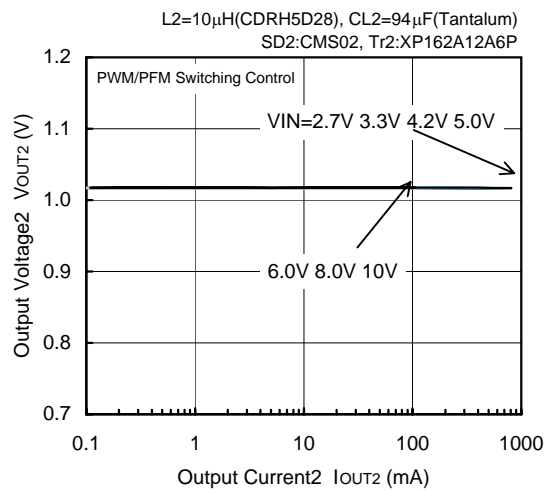

**FOSC=500kHz, VOUT2=3.3V**

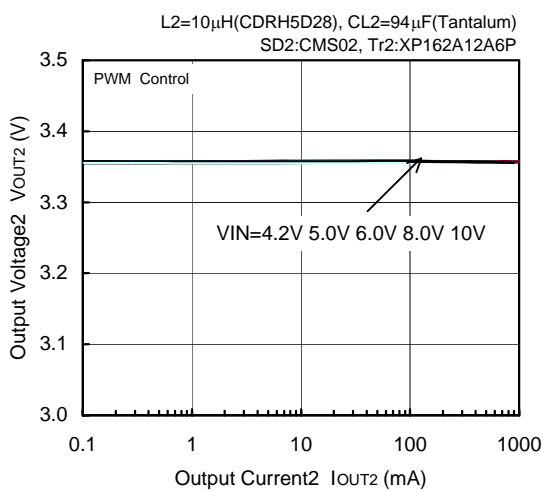

**FOSC=500kHz, VOUT2=3.3V**

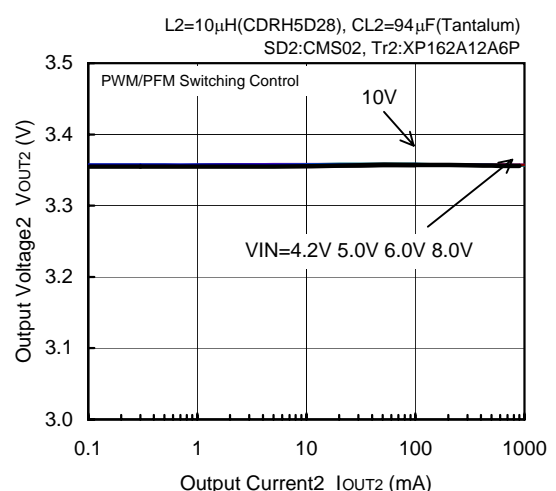

\* When setting VOUT = 1.0V, VIN = 8.0V, 10.0V  
CL should be 94 $\mu$ F (Tantalum) + 100 $\mu$ F (OS capacitor)

**< 2ch Step-down DC/DC Controller >**

(4) Output Voltage vs. Output Current (Continued)

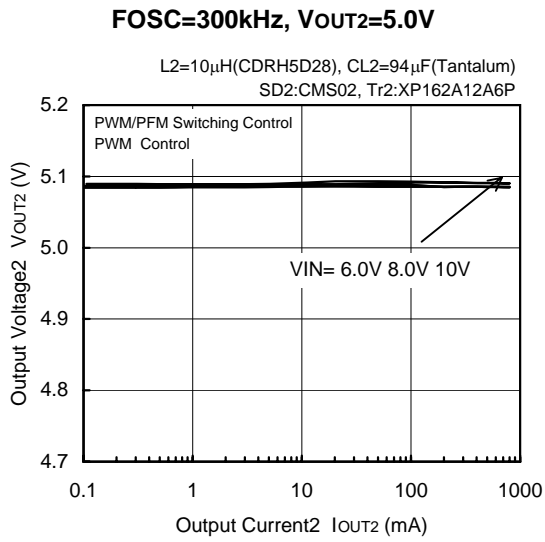

\* When setting V<sub>OUT</sub> = 1.0V, V<sub>IN</sub> = 8.0V, 10.0V  
CL should be 94 $\mu$ F (Tantalum) + 100 $\mu$ F (OS capacitor)

**< 2ch Step-down DC/DC Controller >**

**(5) Efficiency vs. Output Current**

**FOSC=180kHz, VOUT2=1.0V**

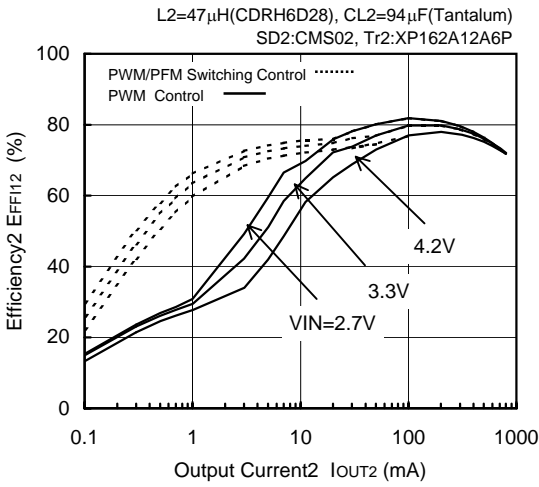

**FOSC=180kHz, VOUT2=1.0V**

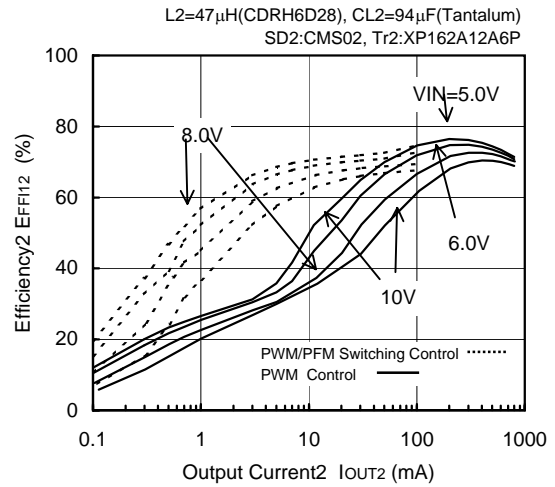

**FOSC=180kHz, VOUT2=3.3V**

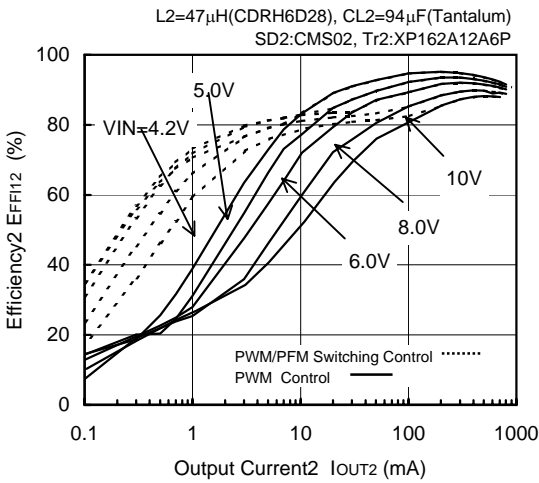

**FOSC=180kHz, VOUT2=5.0V**

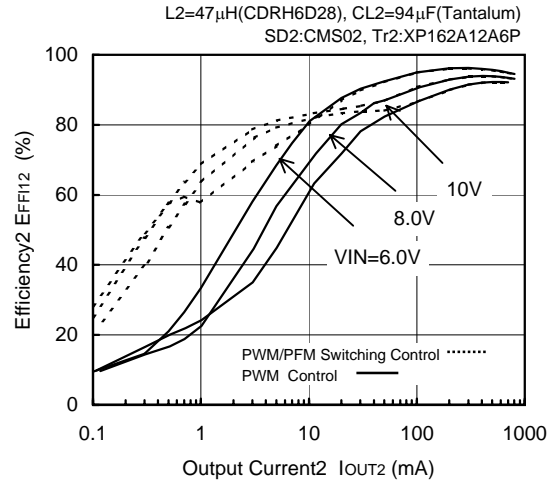

**FOSC=300kHz, VOUT2=1.0V**

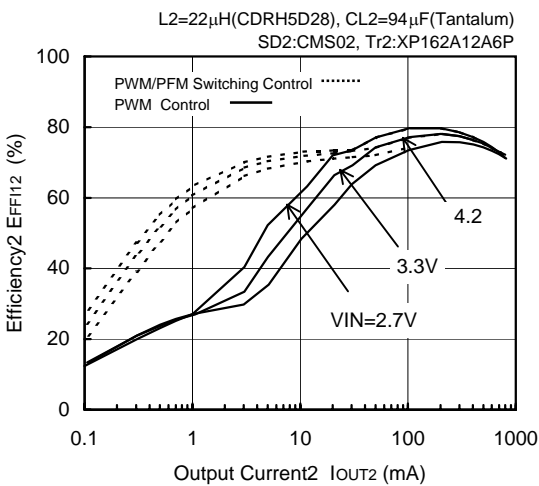

**FOSC=300kHz, VOUT2=1.0V**

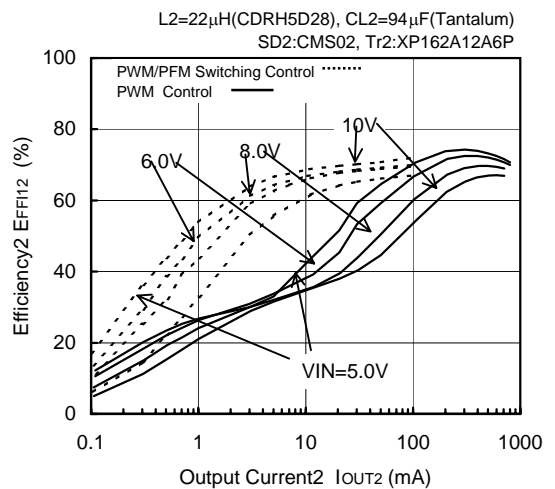

\* When setting VOUT = 1.0V, VIN = 8.0V, 10.0V  
CL should be 94 $\mu$ F (Tantalum) + 100 $\mu$ F (OS capacitor)

**< 2ch Step-down DC/DC Controller >**

(5) Efficiency vs. Output Current (Continued)

**FOSC=300kHz, VOUT2=1.8V**

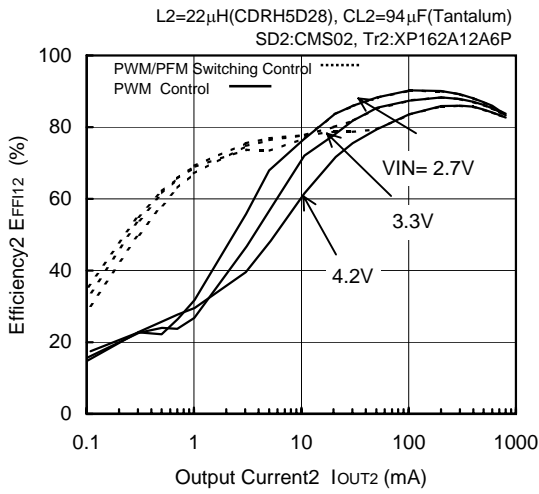

**FOSC=300kHz, VOUT2=1.8V**

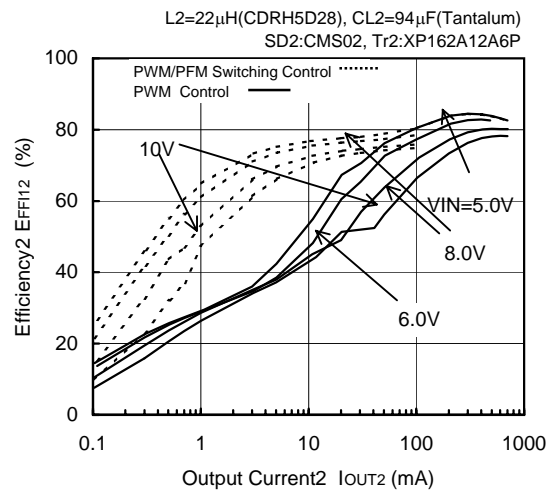

**FOSC=300kHz, VOUT2=2.5V**

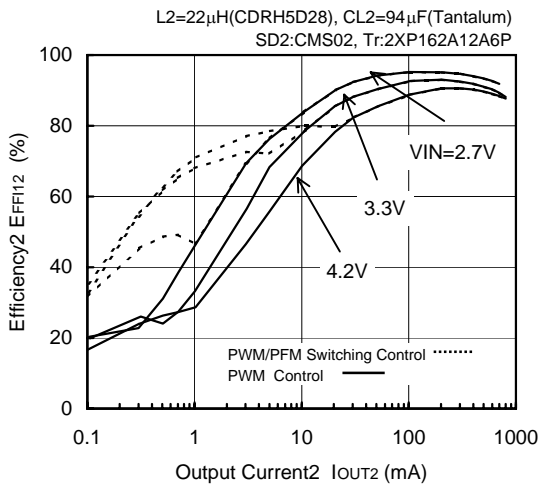

**FOSC=300kHz, VOUT2=2.5V**

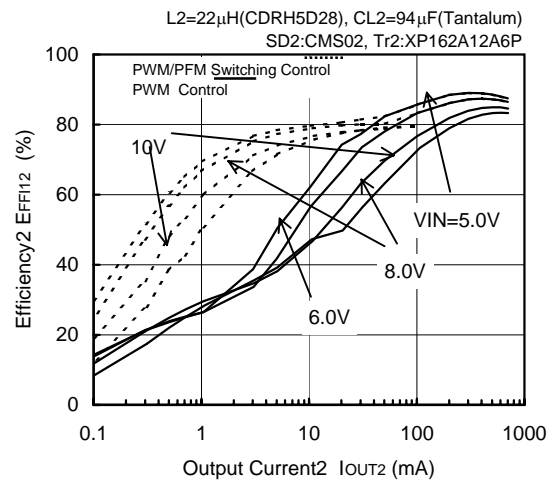

**FOSC=300kHz, VOUT2=3.3V**

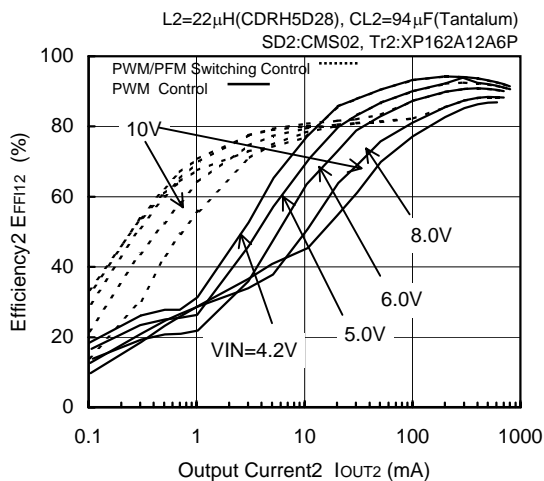

**FOSC=300kHz, VOUT2=5.0V**

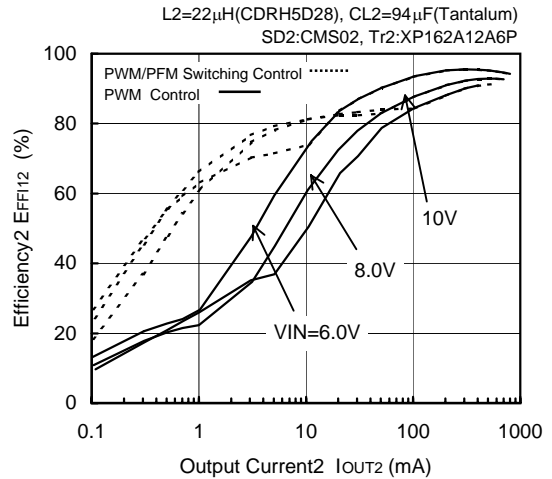

\* When setting VOUT = 1.0V, VIN = 8.0V, 10.0V  
CL should be 94 $\mu$ F (Tantalum) + 100 $\mu$ F (OS capacitor)

### < 2ch Step-down DC/DC Controller >

#### (5) Efficiency vs. Output Current (Continued)

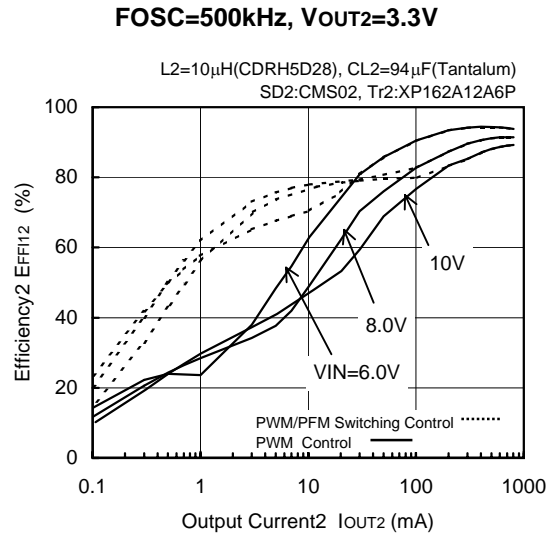
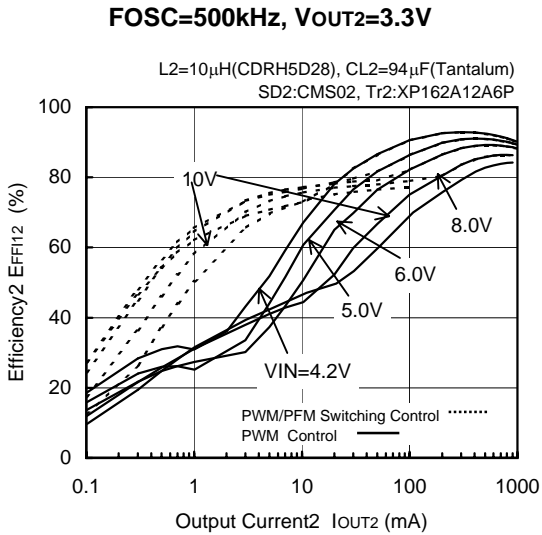
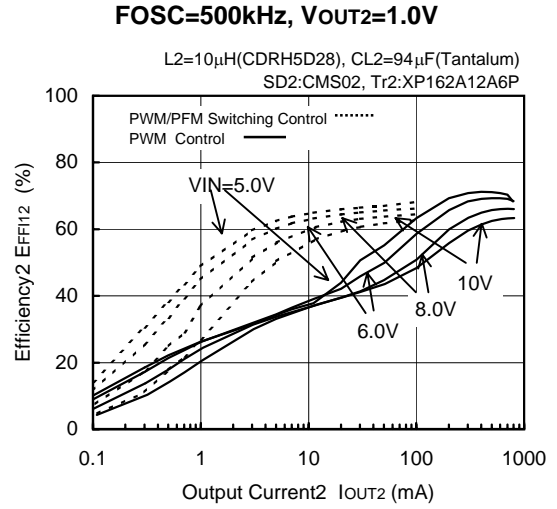
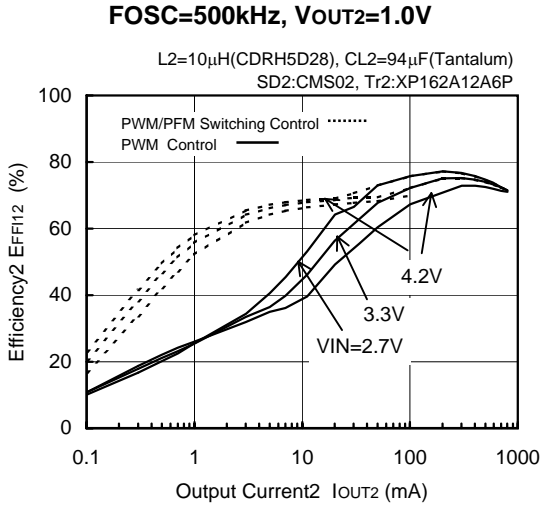

\* When setting VOUT = 1.0V, VIN = 8.0V, 10.0V  
CL should be 94 $\mu$ F (Tantalum) + 100 $\mu$ F (OS capacitor)



### < 2ch Step-down DC/DC Controller >

#### (6) Ripple Voltage vs. Output Current

**FOSC=180kHz, VOUT2=1.0V**

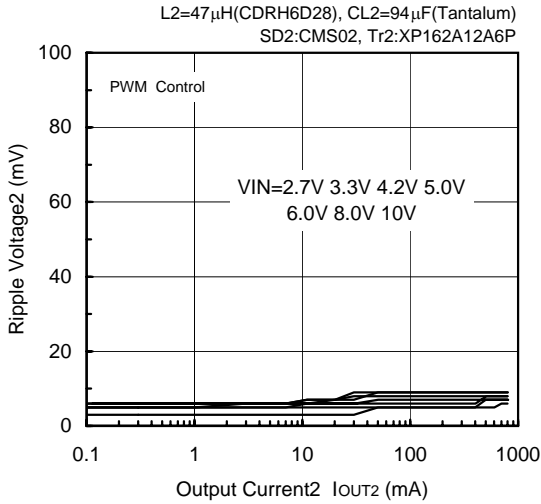

**FOSC=180kHz, VOUT2=1.0V**

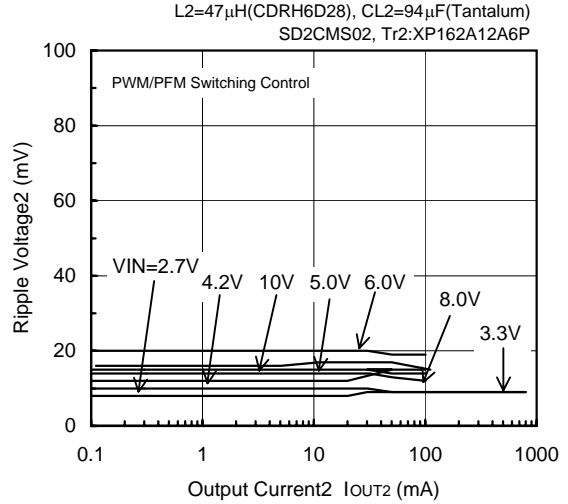

**FOSC=180kHz, VOUT2=3.3V**

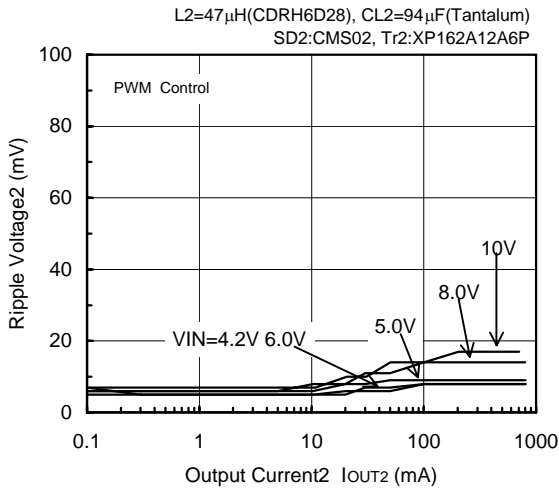

**FOSC=180kHz, VOUT2=3.3V**

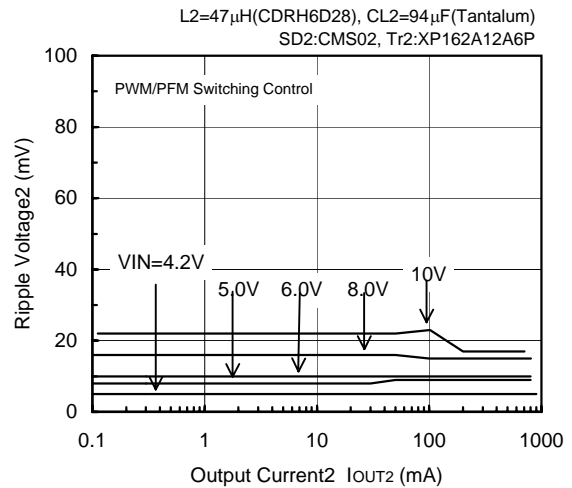

**FOSC=180kHz, VOUT2=5.0V**

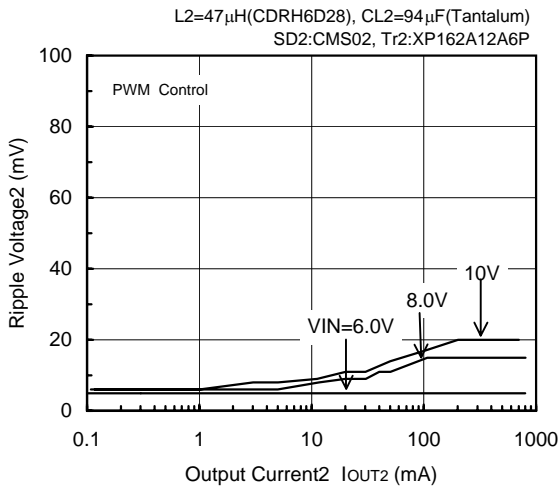

**FOSC=180kHz, VOUT2=5.0V**

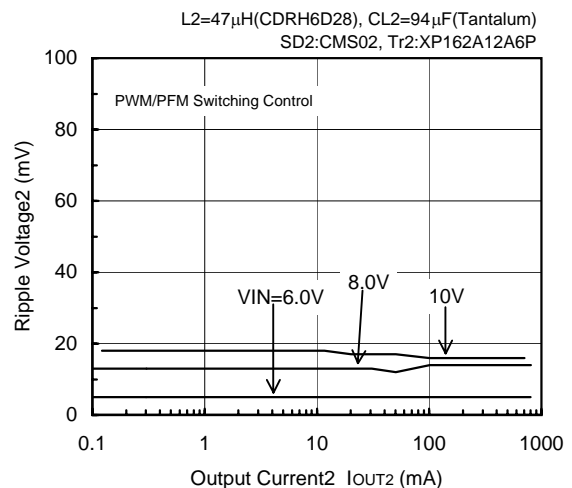

\* When setting VOUT = 1.0V, VIN = 8.0V, 10.0V  
CL should be 94 $\mu$ F (Tantalum) + 100 $\mu$ F (OS capacitor)

### < 2ch Step-down DC/DC Controller >

#### (6) Ripple Voltage vs. Output Current (Continued)

**FOSC=300kHz, VOUT2=1.0V**

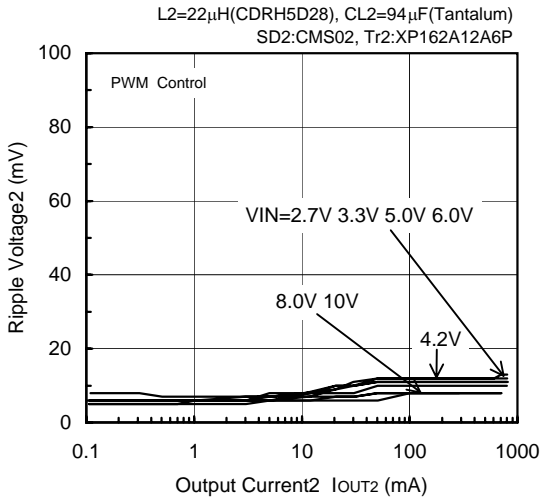

**FOSC=300kHz, VOUT2=1.0V**

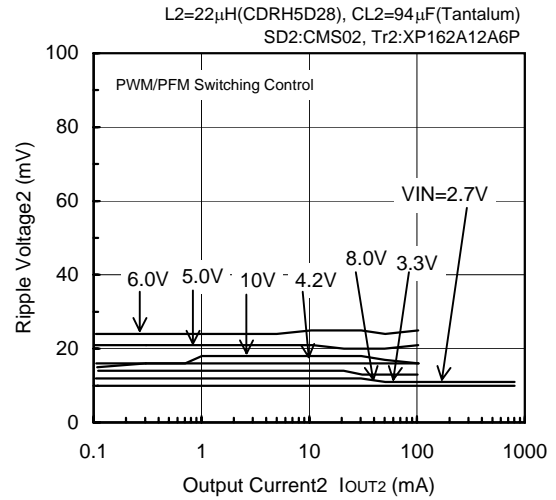

**FOSC=300kHz, VOUT2=1.8V**

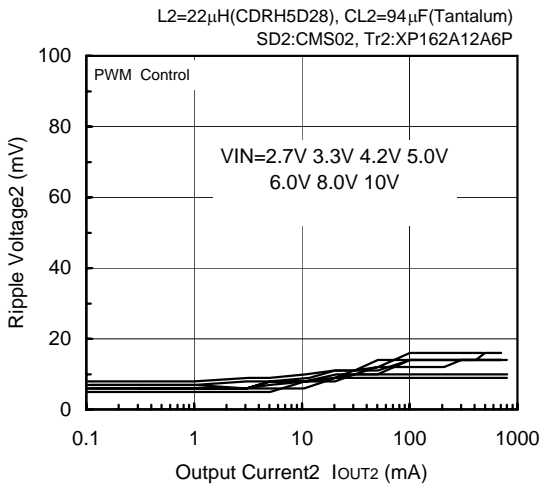

**FOSC=300kHz, VOUT2=1.8V**

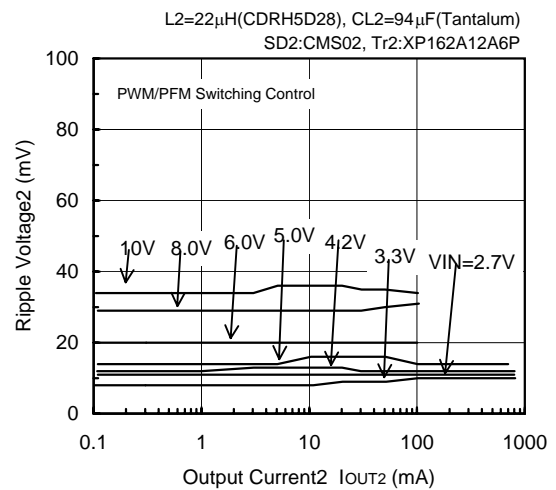

**FOSC=300kHz, VOUT2=2.5V**

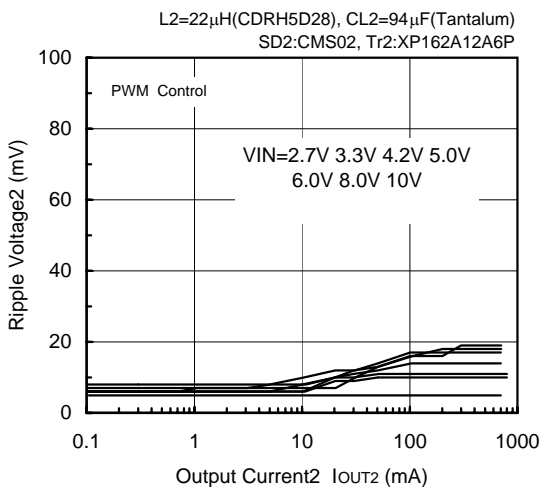

**FOSC=300kHz, VOUT2=2.5V**

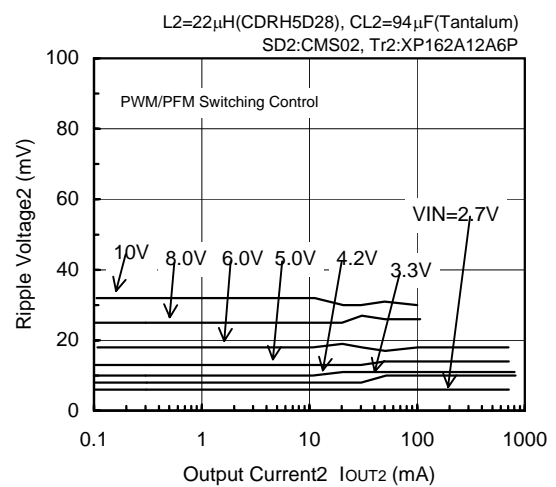

\* When setting VOUT = 1.0V, VIN = 8.0V, 10.0V  
CL should be 94 $\mu$ F (Tantalum) + 100 $\mu$ F (OS capacitor)

### < 2ch Step-down DC/DC Controller >

#### (6) Ripple Voltage vs. Output Current (Continued)

**FOSC=300kHz, VOUT2=3.3V**

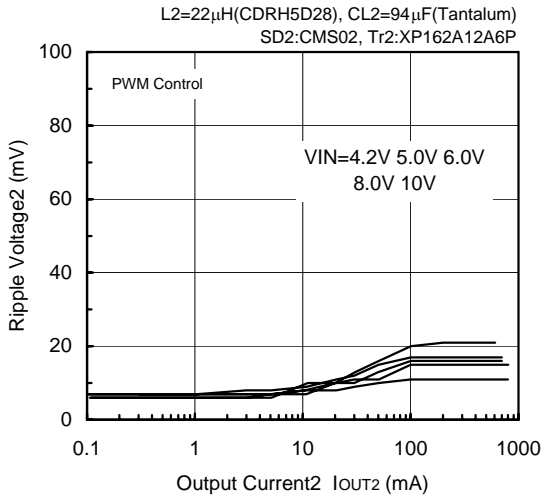

**FOSC=300kHz, VOUT2=3.3V**

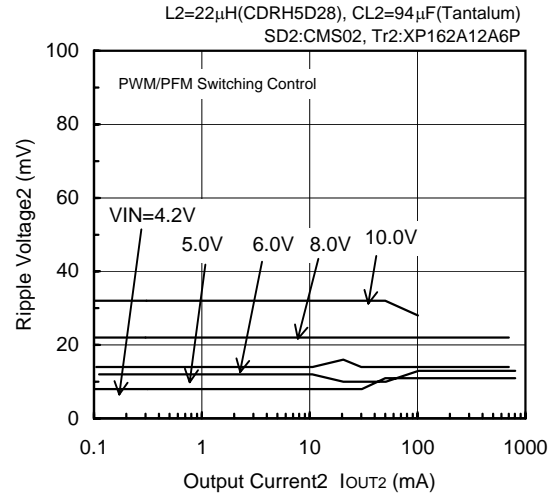

**FOSC=300kHz, VOUT2=5.0V**

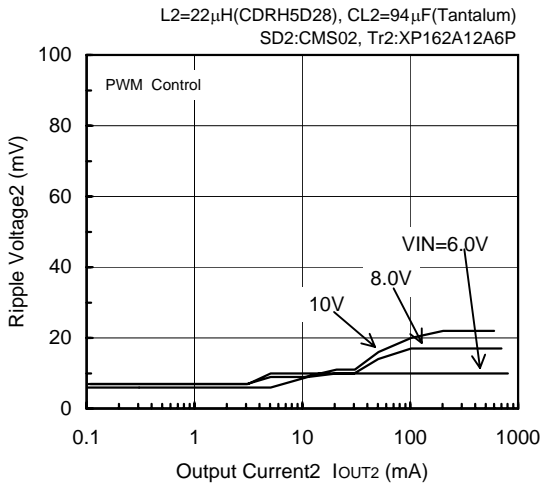

**FOSC=300kHz, VOUT2=5.0V**

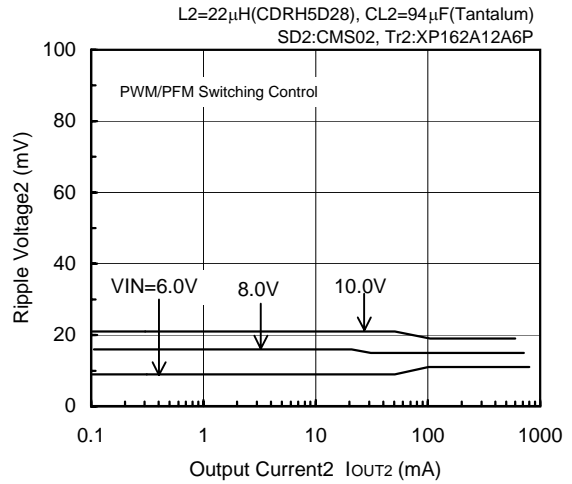

**FOSC=500kHz, VOUT2=1.0V**

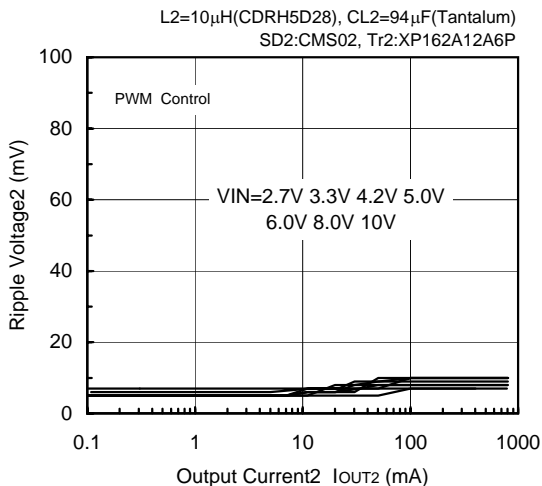

**FOSC=500kHz, VOUT2=1.0V**

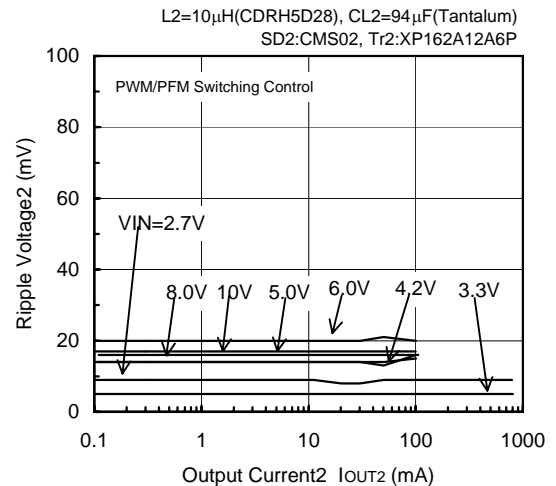

\* When setting VOUT = 1.0V, VIN = 8.0V, 10.0V  
CL should be 94 $\mu$ F (Tantalum) + 100 $\mu$ F (OS capacitor)

### < 2ch Step-down DC/DC Controller >

(6) Ripple Voltage vs. Output Current (Continued)

**FOSC=500kHz, V<sub>OUT2</sub>=3.3V**

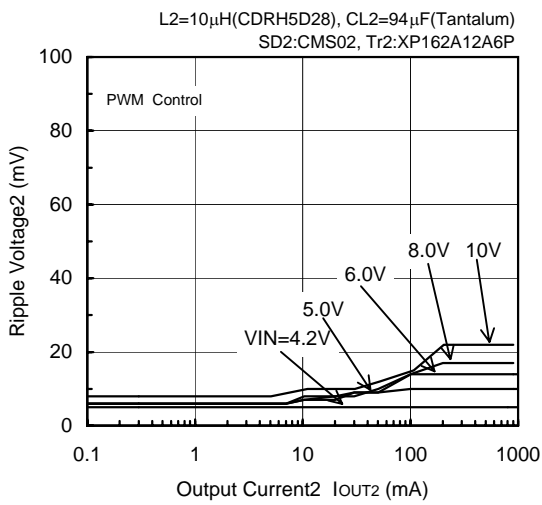

**FOSC=500kHz, V<sub>OUT2</sub>=3.3V**

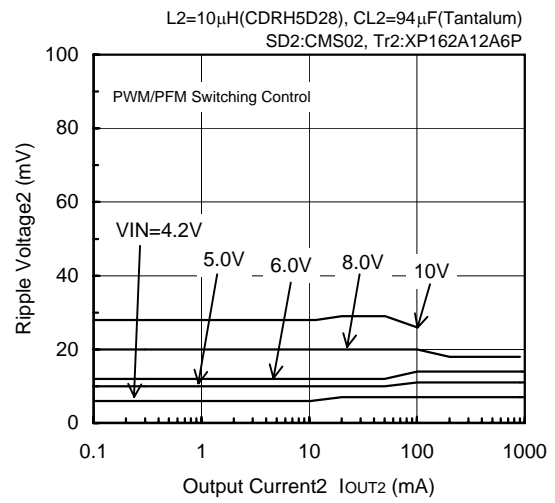

**FOSC=500kHz, V<sub>OUT2</sub>=5.0V**

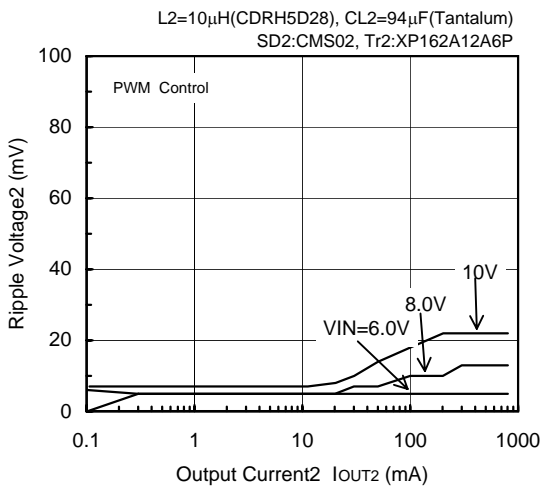

**FOSC=500kHz, V<sub>OUT2</sub>=5.0V**

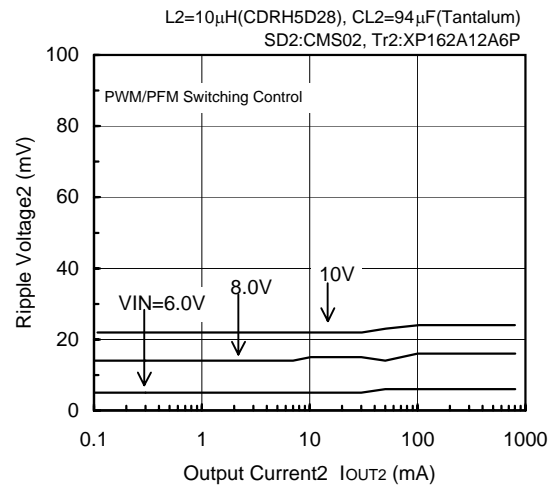

\* When setting V<sub>OUT</sub> = 1.0V, V<sub>IN</sub> = 8.0V, 10.0V  
CL should be 94 $\mu$ F (Tantalum) + 100 $\mu$ F (OS capacitor)

## Typical Performance Characteristics

(7) Supply Current vs. Supply Voltage

**XC9502B092 (180kHz)**

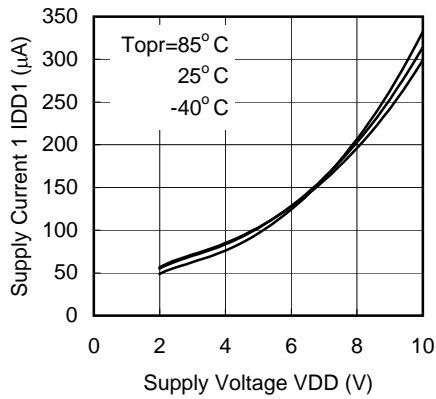

(8) Supply Current 1-1 vs. Supply Voltage

**XC9502B092 (180kHz)**

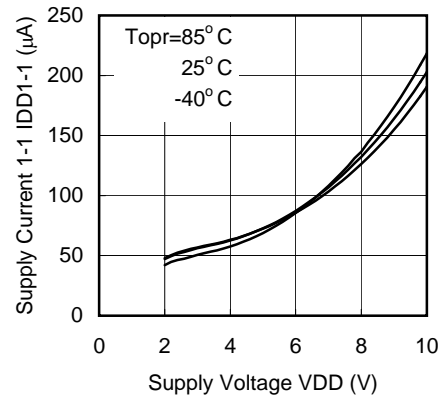

(9) Supply Current 1-2 vs. Supply Voltage

**XC9502B092 (180kHz)**

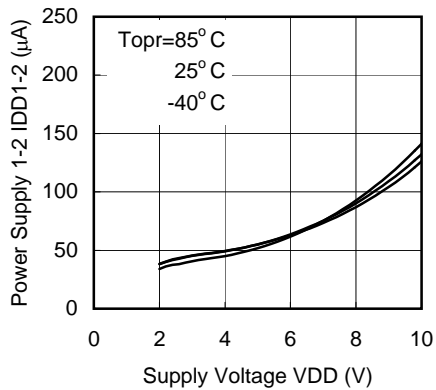

(10) Supply Current 1-3 vs. Supply Voltage

**XC9502B092 (180kHz)**

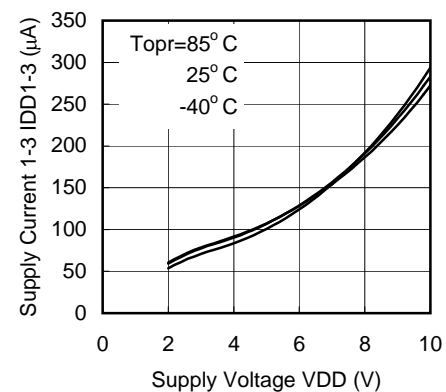

(11) Supply Current 1-4 vs. Supply Voltage

**XC9502B092 (180kHz)**

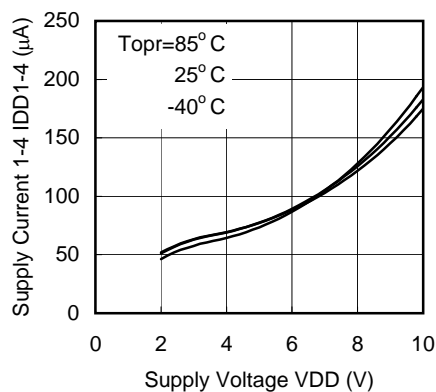

(12) Supply Current 2 vs. Supply Voltage

**XC9502B092 (180kHz)**

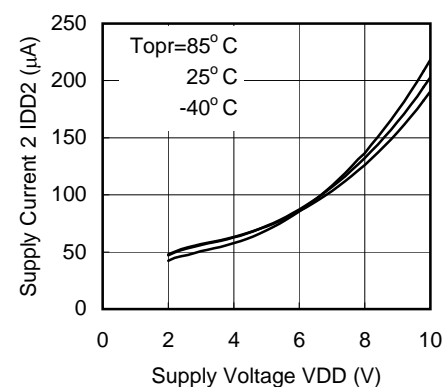

(13) Oscillation Frequency vs. Supply Voltage

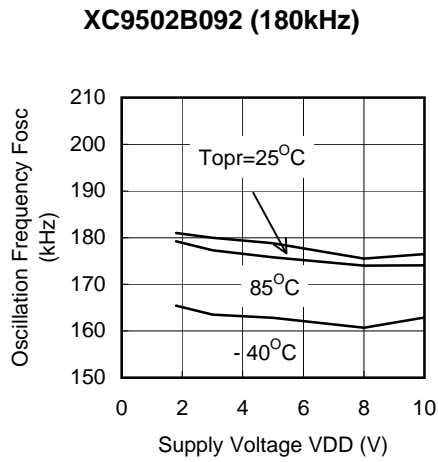

(14) Standby Current vs. Supply Voltage

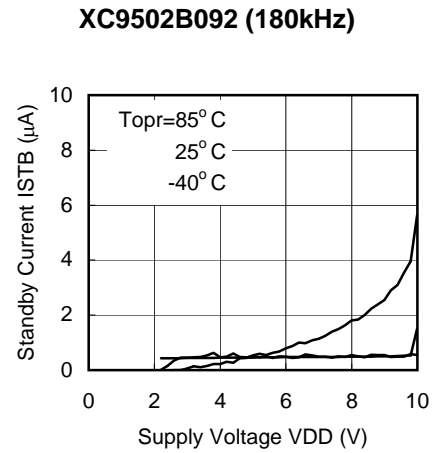

(15) PWM1, 2 'H' 'L' Voltage vs. Supply Voltage

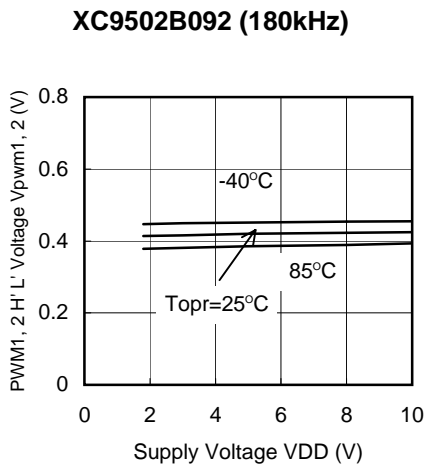

(16) EN1, 2 'H' 'L' Voltage vs. Supply Voltage

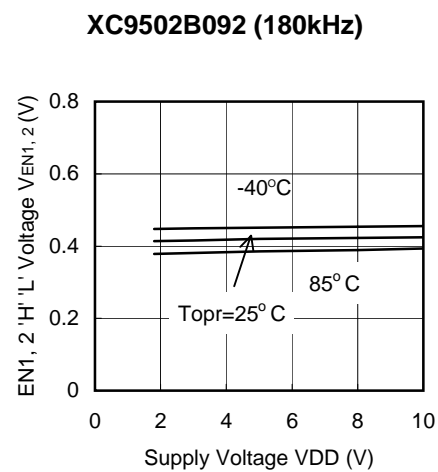

(17) Maximum Duty Ratio 1 vs. Supply Voltage

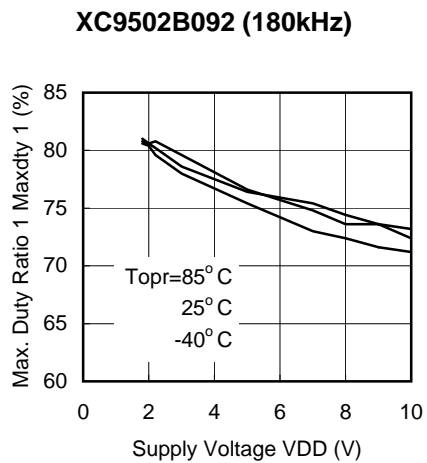

(18) PFM Duty Ratio 1, 2 vs. Supply Voltage

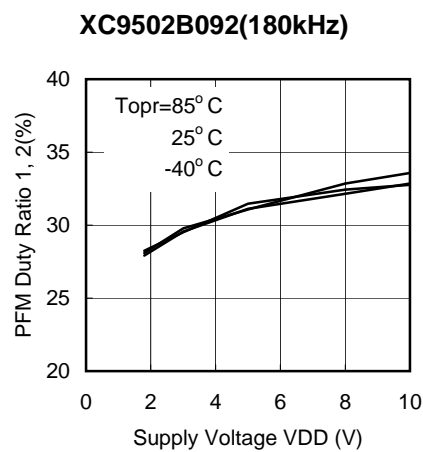

(19) EXT 1, 2 High ON Resistance vs. Supply Voltage

**XC9502B092 (180kHz)**

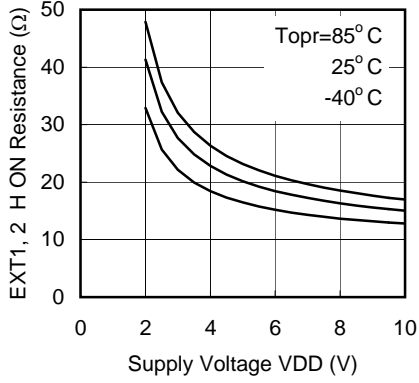

(20) EXT 1, 2 Low ON Resistance vs. Supply Voltage

**XC9502B092 (180kHz)**

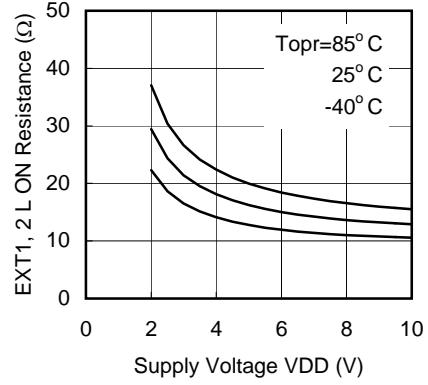

(21) Output Voltage vs. Ambient Temperature

**XC9502B093(300kHz)**

L=22μH(CDRH5D28), CL=94μF(Tantalum)  
Tr:XP161A1265P, SD:CMS02

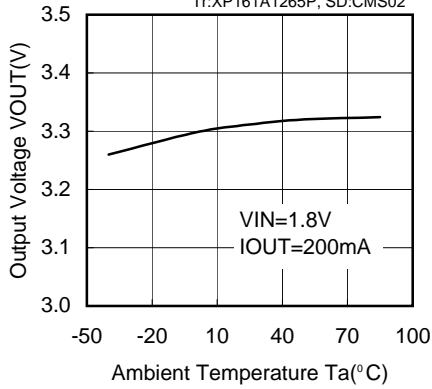

(22) Oscillation Start-up Voltage vs. Ambient Temperature

**XC9502B092 (180kHz, VOUT1=2.0V)**

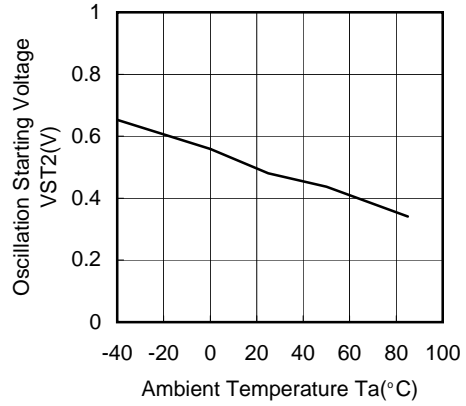

(23) Operation Retention Voltage vs. Ambient Temperature

**XC9502B092(180kHz, VOUT1=3.3V)**

L=22μH(CDRH5D28), CL=47μF(Tantalum)  
SD:MA2Q737, Tr:2SD1628G

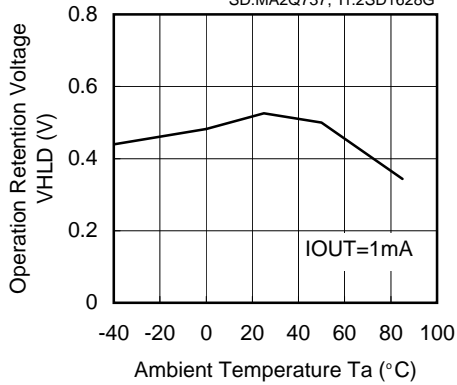

(24) Operation Start-up Voltage vs. Ambient Temperature

**XC9502B092(180kHz, VOUT1=3.3V)**

L=22μH(CDRH5D28), CL=47μF(Tantalum)  
SD:MA2Q737, Tr:2SD1628G

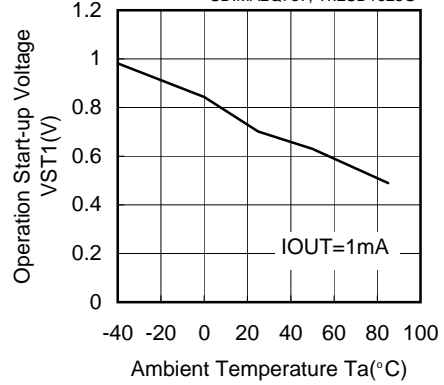

(25) Soft-Start Time 1, 2 vs. Supply Voltage

**XC9502B092 (180kHz)**

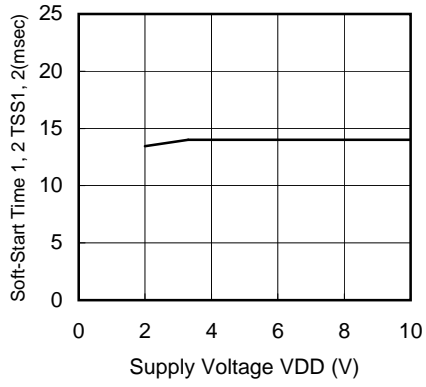



■ Load Transient Response  
[1 channel : Step-up DC/DC Controller]

<  $V_{OUT1} = 3.3V$ ,  $V_{IN} = 2.0V$        $I_{OUT1, 2} = 100\mu A \leftrightarrow 100mA$  >

○ PWM Control

FOSC=180kHz,  $V_{OUT1}=3.3V$   
 $V_{IN}=2.0V$ ,  $I_{OUT1}=100\mu A \rightarrow 100mA$

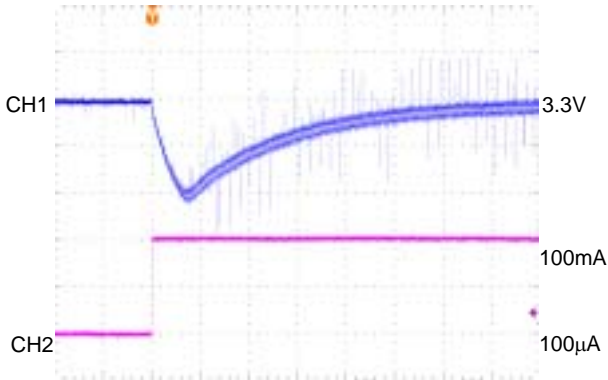

200µsec/div  
CH1:  $V_{OUT1}$ , AC-COUPLED, 50mV/div  
CH2:  $I_{OUT1}$ , 50mA/div

FOSC=180kHz,  $V_{OUT1}=3.3V$   
 $V_{IN}=2.0V$ ,  $I_{OUT1}=100mA \rightarrow 100\mu A$

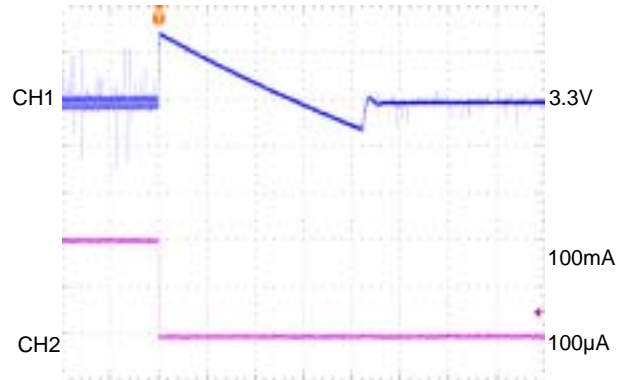

10msec/div  
CH1:  $V_{OUT1}$ , AC-COUPLED, 50mV/div  
CH2:  $I_{OUT1}$ , 50mA/div

○ PWM/PFM Switching Control

FOSC=180kHz,  $V_{OUT1}=3.3V$   
 $V_{IN}=2.0V$ ,  $I_{OUT1}=100\mu A \rightarrow 100mA$

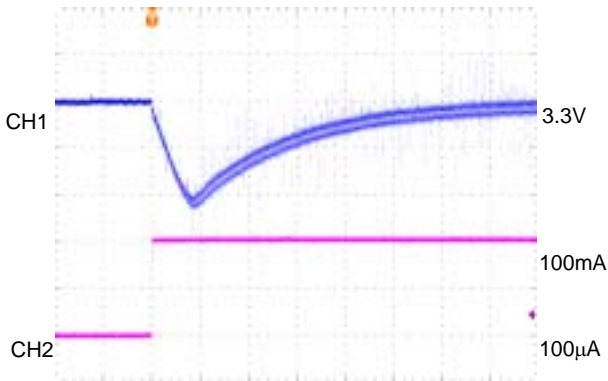

200µsec/div  
CH1:  $V_{OUT1}$ , AC-COUPLED, 50mV/div  
CH2:  $I_{OUT1}$ , 50mA/div

FOSC=180kHz,  $V_{OUT1}=3.3V$   
 $V_{IN}=2.0V$ ,  $I_{OUT1}=100mA \rightarrow 100\mu A$



10msec/div  
CH1:  $V_{OUT1}$ , AC-COUPLED, 50mV/div  
CH2:  $I_{OUT1}$ , 50mA/div

### ■ Load Transient Response

[1 channel : Step-up DC/DC Controller]

<  $V_{OUT1} = 3.3V$ ,  $V_{IN} = 2.0V$   $I_{OUT1, 2} = 10mA \leftrightarrow 100mA$  >

### ○ PWM Control

FOSC=180kHz,  $V_{OUT1}=3.3V$   
 $V_{IN}=2.0V$ ,  $I_{OUT1}=10mA \rightarrow 100mA$

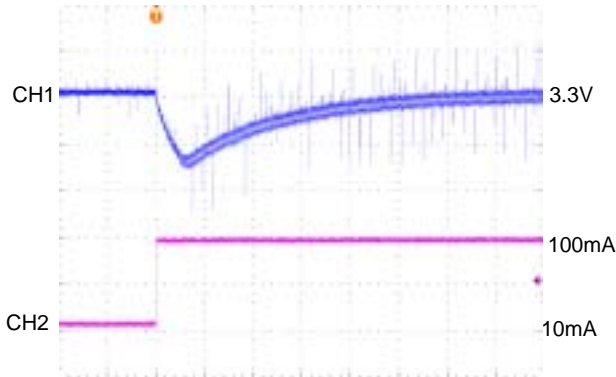

200 $\mu$ sec/div

CH1:  $V_{out1}$ , AC-COUPLED, 50mV/div  
 CH2:  $I_{out1}$ , 50mA/div

FOSC=180kHz,  $V_{OUT1}=3.3V$   
 $V_{IN}=2.0V$ ,  $I_{OUT1}=100mA \rightarrow 10mA$

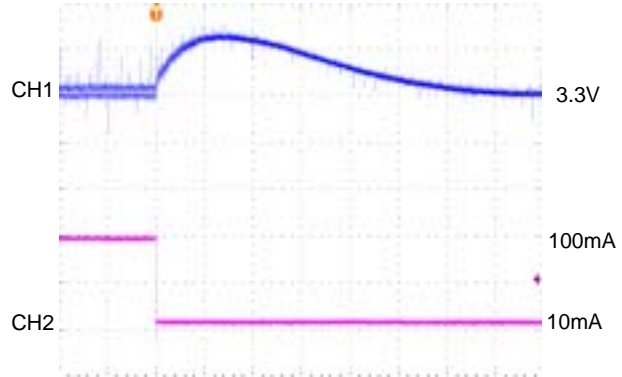

200 $\mu$ sec/div

CH1:  $V_{out1}$ , AC-COUPLED, 50mV/div  
 CH2:  $I_{out1}$ , 50mA/div

### ○ PWM/PFM Switching Control

FOSC=180kHz,  $V_{OUT1}=3.3V$   
 $V_{IN}=2.0V$ ,  $I_{OUT1}=10mA \rightarrow 100mA$

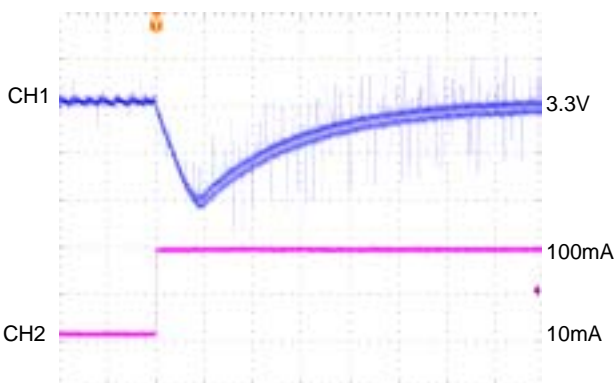

200 $\mu$ sec/div

CH1:  $V_{out1}$ , AC-COUPLED, 50mV/div  
 CH2:  $I_{out1}$ , 50mA/div

FOSC=180kHz,  $V_{OUT1}=3.3V$   
 $V_{IN}=2.0V$ ,  $I_{OUT1}=100mA \rightarrow 10mA$

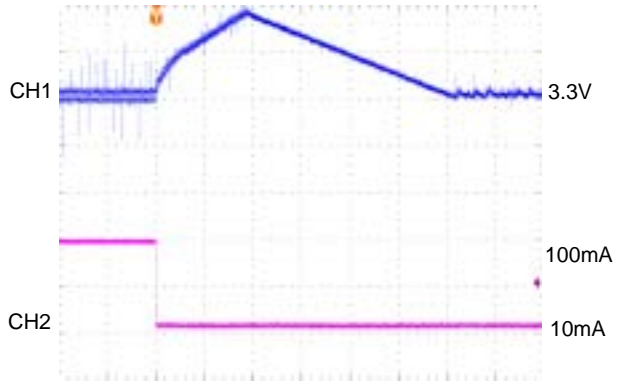

200 $\mu$ sec/div

CH1:  $V_{out1}$ , AC-COUPLED, 50mV/div  
 CH2:  $I_{out1}$ , 50mA/div

■ Load Transient Response  
 [1 channel : Step-up DC/DC Controller]

<PWM Control ⇔ PWM/PFM Switching Control>

FOSC=180kHz, VOUT1=3.3V  
 VIN=2.0V, IOUT1=1mA PWM1 'L'→'H'

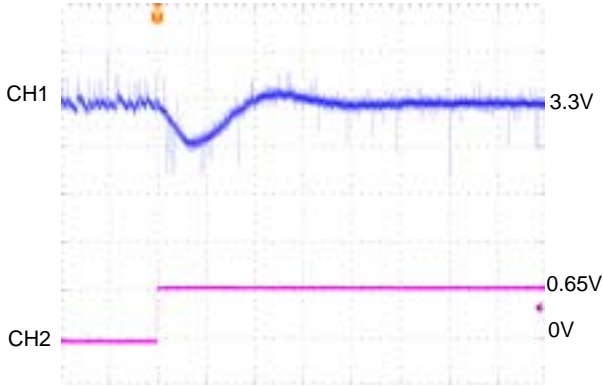

1msec/div  
 CH1:VOUT1 , AC-COUPLED ,10mV/div  
 CH2:PWM1 , 0.5V/div

FOSC=180kHz, VOUT1=3.3V  
 VIN=2.0V, IOUT1=1mA PWM1 'H'→'L'

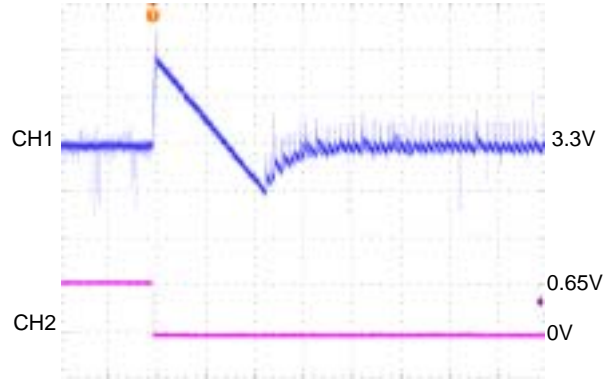

1msec/div  
 CH1:VOUT1, AC-COUPLED ,10mV/div  
 CH2:PWM1, 0.5V/div

<Soft Start Wave Form>

FOSC=180kHz, VOUT1=3.3V  
 VIN=2.0V, IOUT1=100mA EN1 'L'→'H'  
 CIN=47μF

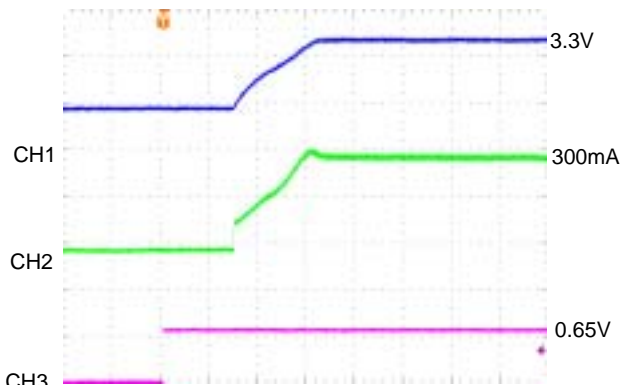

4ms/div  
 CH1:VOUT1, 1.0V/div  
 CH2:IIN1, 100mA/div  
 CH3:EN1 , 0.5V/div

\* EN2=GND

■ Load Transient Response  
 [2 channel : Step-down DC/DC Controller]

< VOUT2=3.3V, VIN=5.0V IOUT2=100μA ↔ 300mA >

○ PWM Control

FOSC=300kHz, VOUT2=3.3V  
 VIN=5.0V, IOUT2=100μA → 300mA

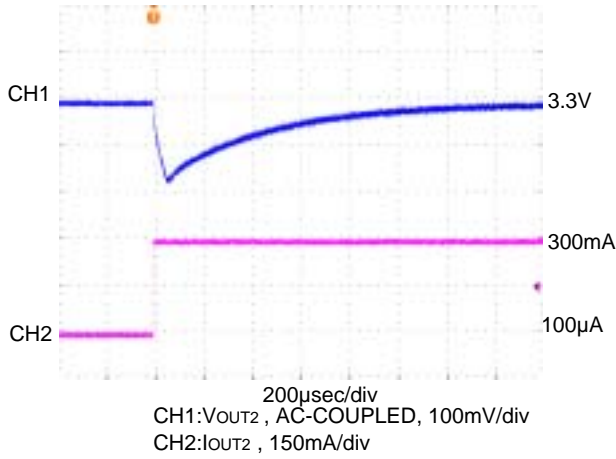

FOSC=300kHz, VOUT2=3.3V  
 VIN=5.0V, IOUT2=300mA → 100μA

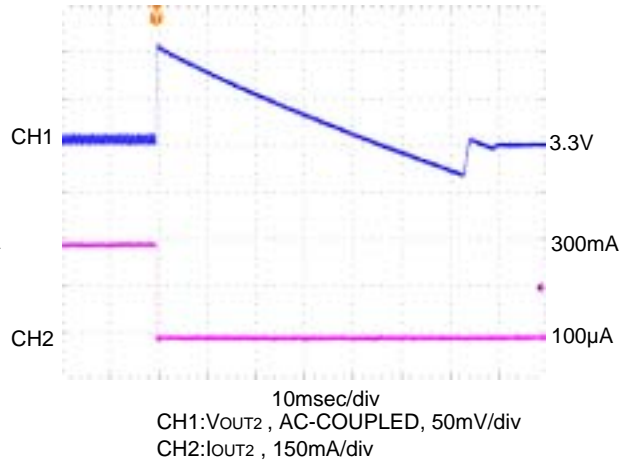

○ PWM/PFM Switching Control

FOSC=300kHz, VOUT2=3.3V  
 VIN=5.0V, IOUT2=100μA → 300mA

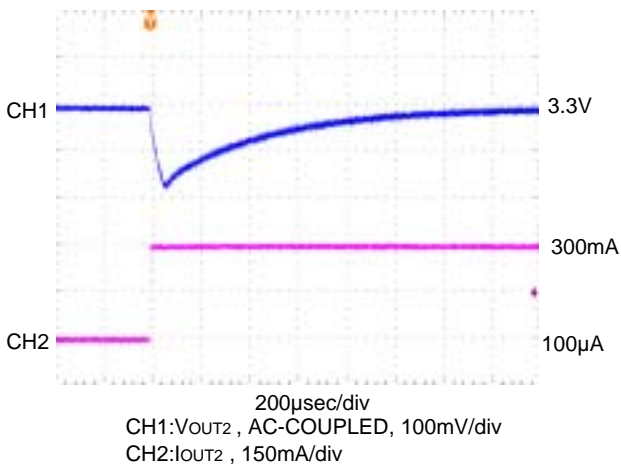

FOSC=300kHz, VOUT2=3.3V  
 VIN=5.0V, IOUT2=300mA → 100μA

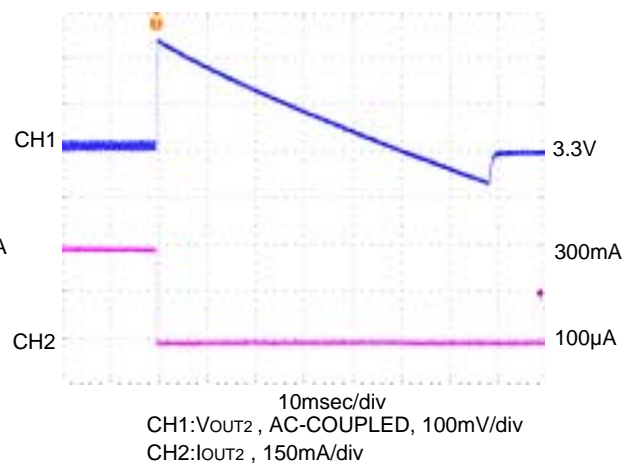

■ Load Transient Response  
[2 channel : Step-down DC/DC Controller]

< VOUT2=3.3V, VIN=5.0V IOUT2=10mA ↔ 300mA >

○ PWM Control

FOSC=300kHz, VOUT2=3.3V  
VIN=5.0V, IOUT2=10mA → 300mA

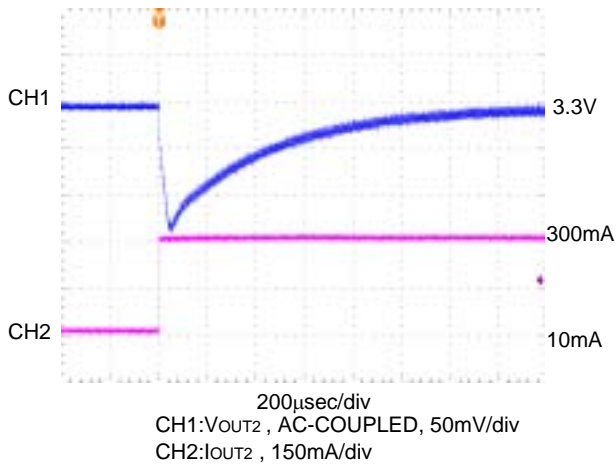

FOSC=300kHz, VOUT2=3.3V  
VIN=5.0V, IOUT2=300mA → 10mA

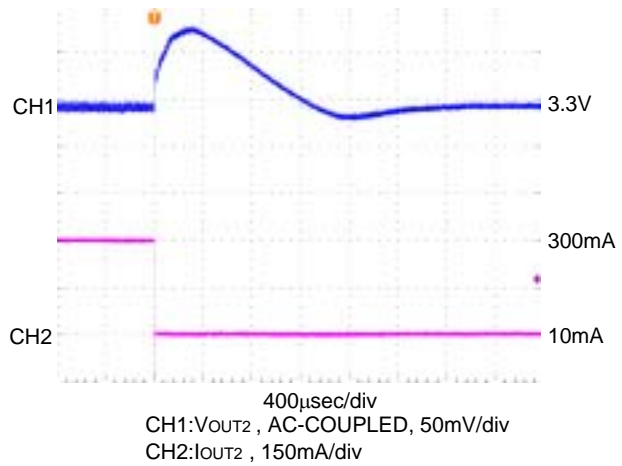

○ PWM/PFM Switching Control

FOSC=300kHz, VOUT2=3.3V  
VIN=5.0V, IOUT2=10mA → 300mA

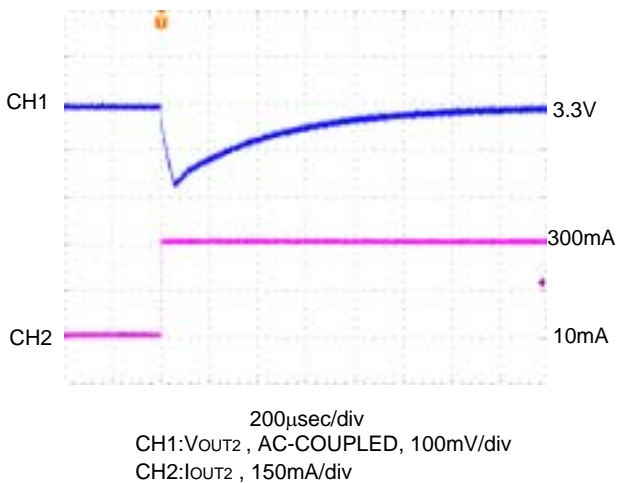

FOSC=300kHz, VOUT2=3.3V  
VIN=5.0V, IOUT2=300mA → 10mA

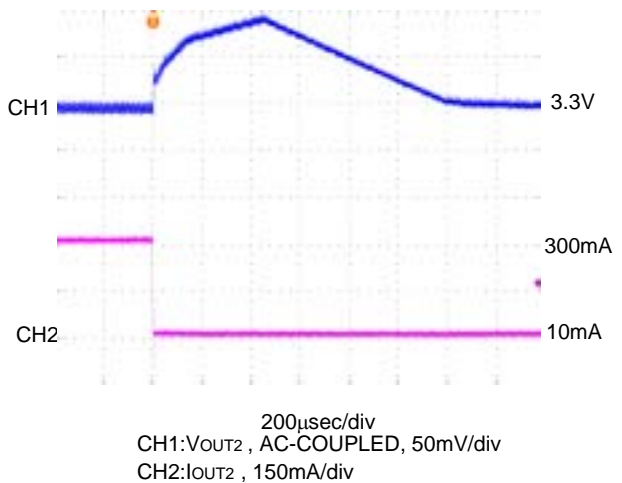

### ■ Load Transient Response

[2 channel : Step-down DC/DC Controller]

<  $V_{OUT2}=0.9V$ ,  $V_{IN}=3.3V$   $I_{OUT2}=100\mu A \leftrightarrow 300mA$  >

### ○ PWM Control

FOSC=300kHz,  $V_{OUT2}=0.9V$   
 $V_{IN}=3.3V$ ,  $I_{OUT2}=100\mu A \rightarrow 300mA$

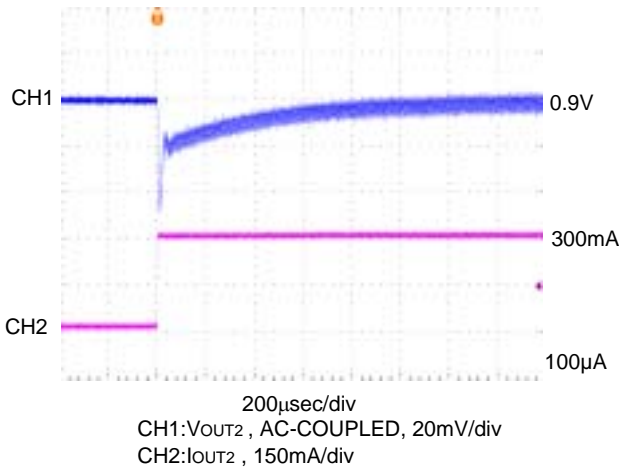

FOSC=300kHz,  $V_{OUT2}=0.9V$   
 $V_{IN}=3.3V$ ,  $I_{OUT2}=300mA \rightarrow 100\mu A$

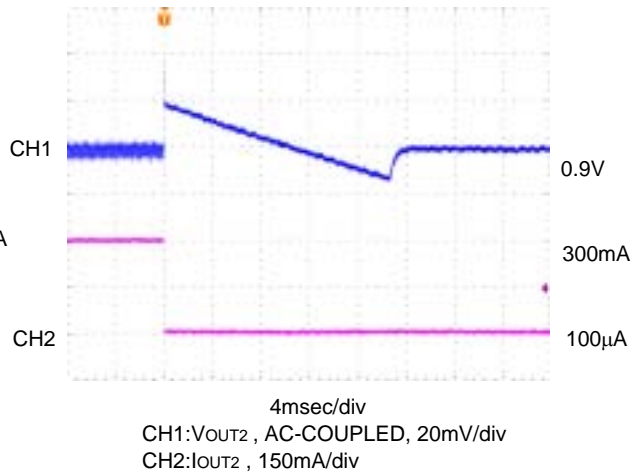

### ○ PWM/PFM Switching Control

FOSC=300kHz,  $V_{OUT2}=0.9V$   
 $V_{IN}=3.3V$ ,  $I_{OUT2}=100\mu A \rightarrow 300mA$

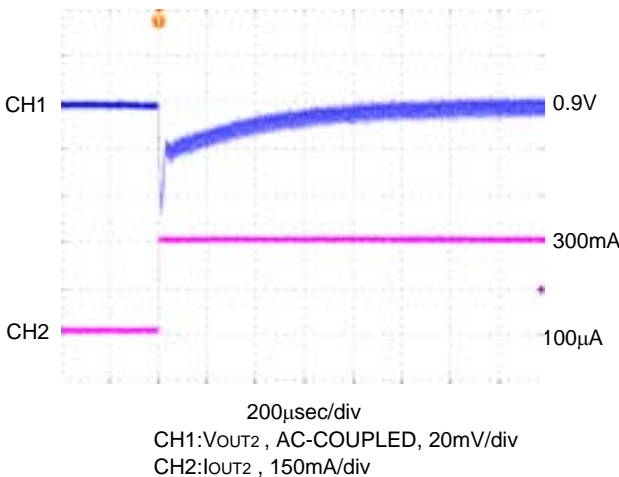

FOSC=300kHz,  $V_{OUT2}=0.9V$   
 $V_{IN}=3.3V$ ,  $I_{OUT2}=300mA \rightarrow 100\mu A$

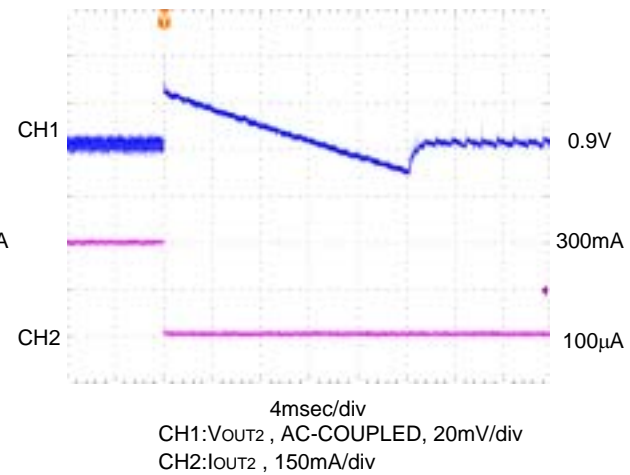

### ■ Load Transient Response

[2 channel : Step-down DC/DC Controller]

<  $V_{OUT2}=0.9V$ ,  $V_{IN}=3.3V$   $I_{OUT2}=10mA \leftrightarrow 300mA$  >

### ○ PWM Control

FOSC=300kHz,  $V_{OUT2}=0.9V$   
 $V_{IN}=3.3V$ ,  $I_{OUT2}=10mA \rightarrow 300mA$

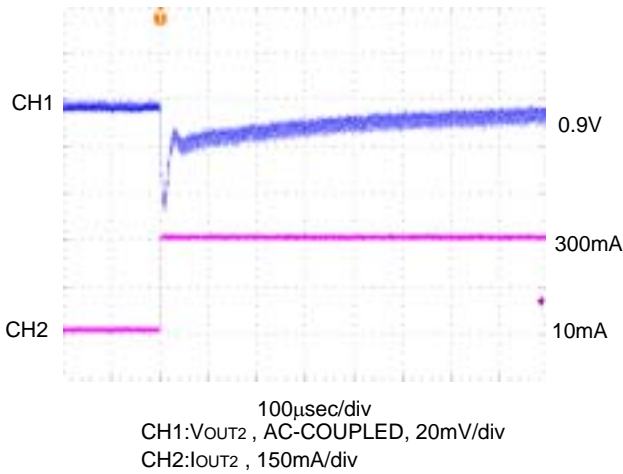

FOSC=300kHz,  $V_{OUT2}=0.9V$   
 $V_{IN}=3.3V$ ,  $I_{OUT2}=300mA \rightarrow 10mA$

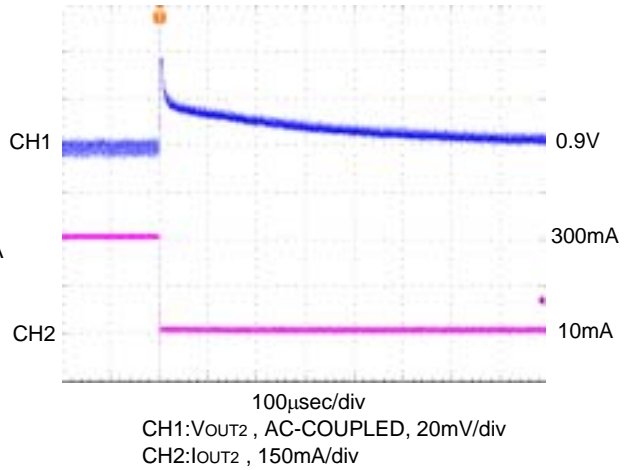

### ○ PWM/PFM Switching Control

FOSC=300kHz,  $V_{OUT2}=0.9V$   
 $V_{IN}=3.3V$ ,  $I_{OUT2}=10mA \rightarrow 300mA$

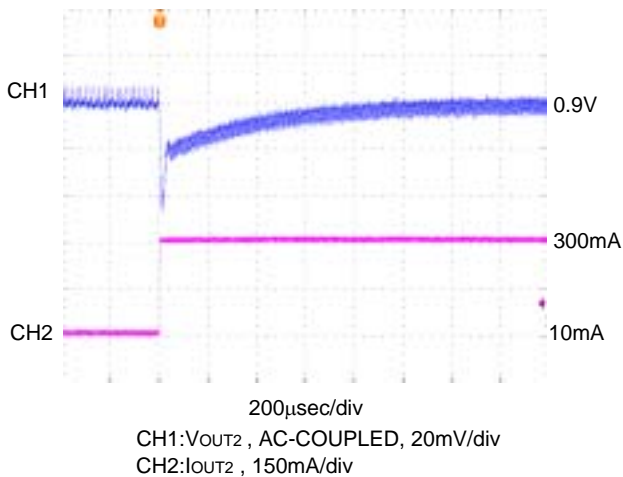

FOSC=300kHz,  $V_{OUT2}=0.9V$   
 $V_{IN}=3.3V$ ,  $I_{OUT2}=300mA \rightarrow 10mA$

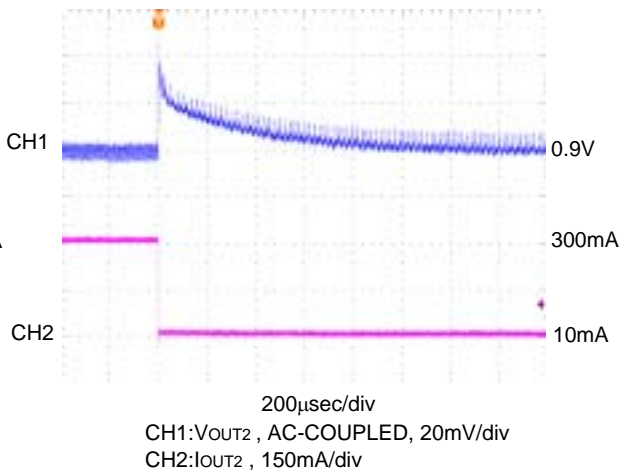

■ Load Transient Response  
[2 channel : Step-down DC/DC Controller]

<PWM Control ⇔ PWM/PFM Switching Control>

FOSC=300kHz, V<sub>OUT2</sub>=3.3V  
VIN=5.0V, I<sub>OUT2</sub>=5mA PWM2 'L'→'H'

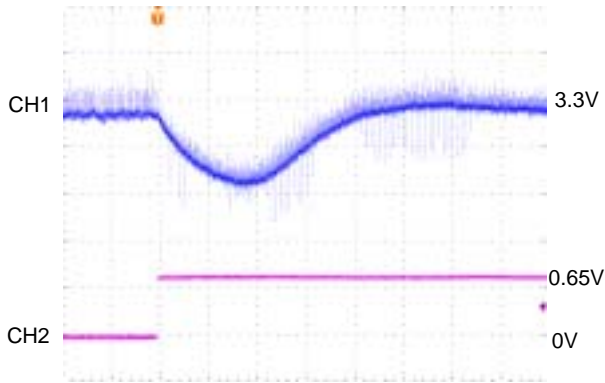

400µsec/div  
CH1:Vout2 , AC-COUPLED ,10mV/div  
CH2:PWM2 , 0.5V/div

FOSC=300kHz, V<sub>OUT2</sub>=3.3V  
VIN=5.0V, I<sub>OUT2</sub>=5mA PWM2 'H'→'L'

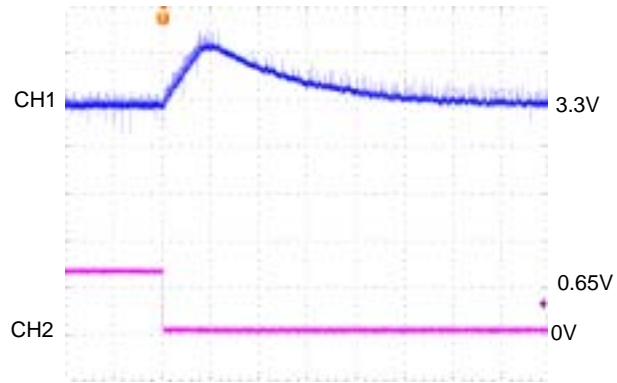

200µsec/div  
CH1:Vout2 , AC-COUPLED ,20mV/div  
CH2:PWM2 , 0.5V/div

<Soft Start Wave Form>

FOSC=300kHz, V<sub>OUT2</sub>=3.3V  
VIN=5.0V, I<sub>OUT2</sub>=300mA EN2 'L'→'H'  
C<sub>IN</sub>=47µF

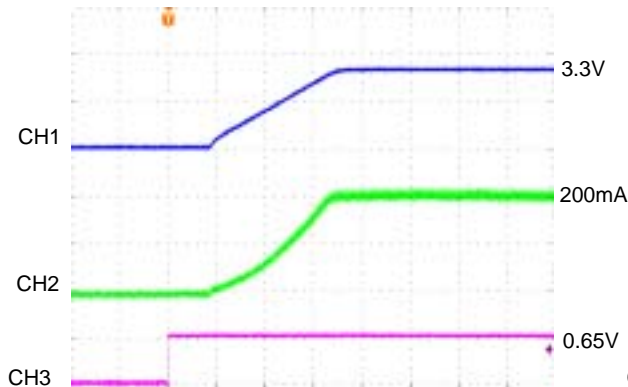

4ms/div  
CH1:Vout2 , 2.0V/div  
CH2:Iin2, 100mA/div  
CH3:EN2 , 0.5V/div

FOSC=300kHz, V<sub>OUT2</sub>=3.3V  
VIN=5.0V, I<sub>OUT2</sub>=100mA EN2 'L'→'H'  
C<sub>IN</sub>=47µF

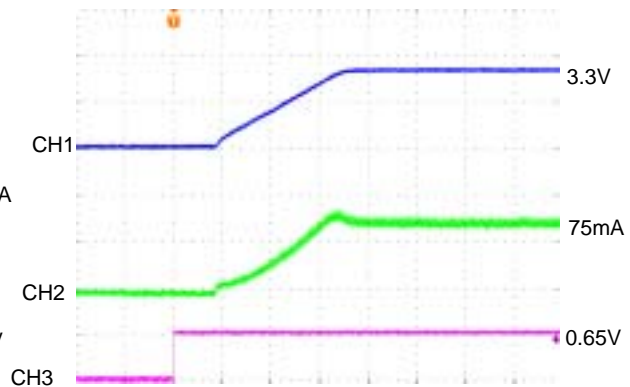

4ms/div  
CH1:Vout2 , 2.0V/div  
CH2:Iin2, 50mA/div  
CH3:EN2 , 0.5V/div

\* EN1=GND





Компания «ЭлектроПласт» предлагает заключение долгосрочных отношений при поставках импортных электронных компонентов на взаимовыгодных условиях!

Наши преимущества:

- Оперативные поставки широкого спектра электронных компонентов отечественного и импортного производства напрямую от производителей и с крупнейших мировых складов;
- Поставка более 17-ти миллионов наименований электронных компонентов;
- Поставка сложных, дефицитных, либо снятых с производства позиций;
- Оперативные сроки поставки под заказ (от 5 рабочих дней);
- Экспресс доставка в любую точку России;
- Техническая поддержка проекта, помощь в подборе аналогов, поставка прототипов;
- Система менеджмента качества сертифицирована по Международному стандарту ISO 9001;
- Лицензия ФСБ на осуществление работ с использованием сведений, составляющих государственную тайну;
- Поставка специализированных компонентов (Xilinx, Altera, Analog Devices, Intersil, Interpoint, Microsemi, Aeroflex, Peregrine, Syfer, Eurofarad, Texas Instrument, Miteq, Cobham, E2V, MA-COM, Hittite, Mini-Circuits, General Dynamics и др.);

Помимо этого, одним из направлений компании «ЭлектроПласт» является направление «Источники питания». Мы предлагаем Вам помощь Конструкторского отдела:

- Подбор оптимального решения, техническое обоснование при выборе компонента;
- Подбор аналогов;
- Консультации по применению компонента;
- Поставка образцов и прототипов;
- Техническая поддержка проекта;
- Защита от снятия компонента с производства.



#### Как с нами связаться

**Телефон:** 8 (812) 309 58 32 (многоканальный)

**Факс:** 8 (812) 320-02-42

**Электронная почта:** [org@eplast1.ru](mailto:org@eplast1.ru)

**Адрес:** 198099, г. Санкт-Петербург, ул. Калинина, дом 2, корпус 4, литера А.