

ESD131-B1-W0201

Protection Devices

TVS (Transient Voltage Suppressor)

Bi-directional, 5.5 V, 0.23 pF, 0201, RoHS and Halogen Free compliant

Features

- ESD / transient protection according to:
 - IEC61000-4-2 (ESD): ± 20 kV (air / contact discharge)
 - IEC61000-4-4 (EFT): ± 2.5 kV / ± 60 A (5/50 ns)
 - IEC61000-4-5 (Surge): ± 3.5 A (8/20 μ s)
- Bi-directional working voltage up to: $V_{RWM} = \pm 5.5$ V
- Line capacitance: $C_L = 0.23$ pF (typical) at $f = 1$ MHz
- Clamping voltage: $V_{CL} = 13$ V (typical) at $I_{TLP} = 16$ A with $R_{DYN} = 0.66 \Omega$ (typical)
- Very low reverse current: $I_R < 100$ nA (max.)
- Small form factor SMD size 0201 and low profile (0.58 mm x 0.28 mm x 0.15 mm)
- Bidirectional and symmetric I/V characteristics for optimized design and assembly
- Pb-free (RoHS compliant) and halogen free package



Guidelines for optimized PCB design and assembly process are available in [\[2\]](#).

Product validation

Qualified for industrial applications according to the relevant tests of JEDEC47/20/22

Application examples

- USB 3.0, Firewire, DVI, HDMI, S-ATA, DisplayPort, Thunderbolt
- Mobile HDMI Link, MDDI, MIPI, SWP / NFC

Device information

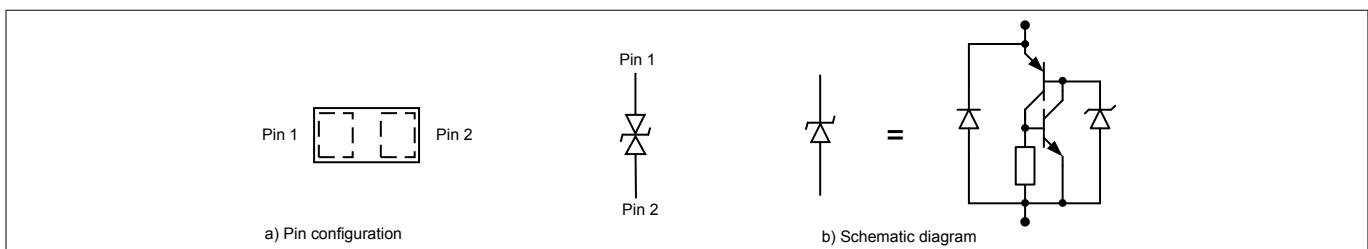

Figure 1 Pin configuration and schematic diagram

Table 1 Part information

| Type | Package | Configuration | Marking code |
|-----------------|---------|------------------------|-----------------|
| ESD131-B1-W0201 | WLL-2-3 | 1 line, bi-directional | T ¹⁾ |

¹ The device does not have any marking on the device top. The marking code is between the pads.

Table of contents

| | | |
|----------|--|----|
| | Features | 1 |
| | Product validation | 1 |
| | Application examples | 1 |
| | Device information | 1 |
| | Table of contents | 2 |
| 1 | Maximum ratings | 3 |
| 2 | Electrical characteristics | 4 |
| 3 | Typical characteristic diagrams | 6 |
| 4 | Package information | 12 |
| 4.1 | WLL-2-3 Package | 12 |
| 5 | References | 13 |
| | Revision history | 13 |
| | Trademarks | 14 |

Maximum ratings

1 Maximum ratings

Note: $T_A = 25\text{ °C}$, unless otherwise specified¹⁾

Table 2 Maximum ratings

| Parameter | Symbol | Values | Unit |
|----------------------------------|---------------------|------------|------|
| Reverse working voltage | V_{RWM} | ± 5.5 | V |
| ESD discharge ²⁾ | V_{ESD} (contact) | ± 20 | kV |
| | V_{ESD} (air) | ± 20 | |
| Peak pulse power ³⁾ | P_{PK} | 26 | W |
| Peak pulse current ³⁾ | I_{PP} | ± 3.5 | A |
| Operating temperature range | T_{OP} | -55 to 125 | °C |
| Storage temperature | T_{stg} | -65 to 150 | °C |

Attention: Stresses above the max. values listed here may cause permanent damage to the device. Exposure to absolute maximum rating conditions for extended periods may affect device reliability. Maximum ratings are absolute ratings. Exceeding only one of these values may cause irreversible damage to the component.

¹ Device is electrically symmetrical

² V_{ESD} according to IEC61000-4-2 (R = 330 Ω , C = 150 pF discharge network)

³ Stress pulse: 8/20 μ s current waveform according to IEC61000-4-5

Electrical characteristics

2 Electrical characteristics

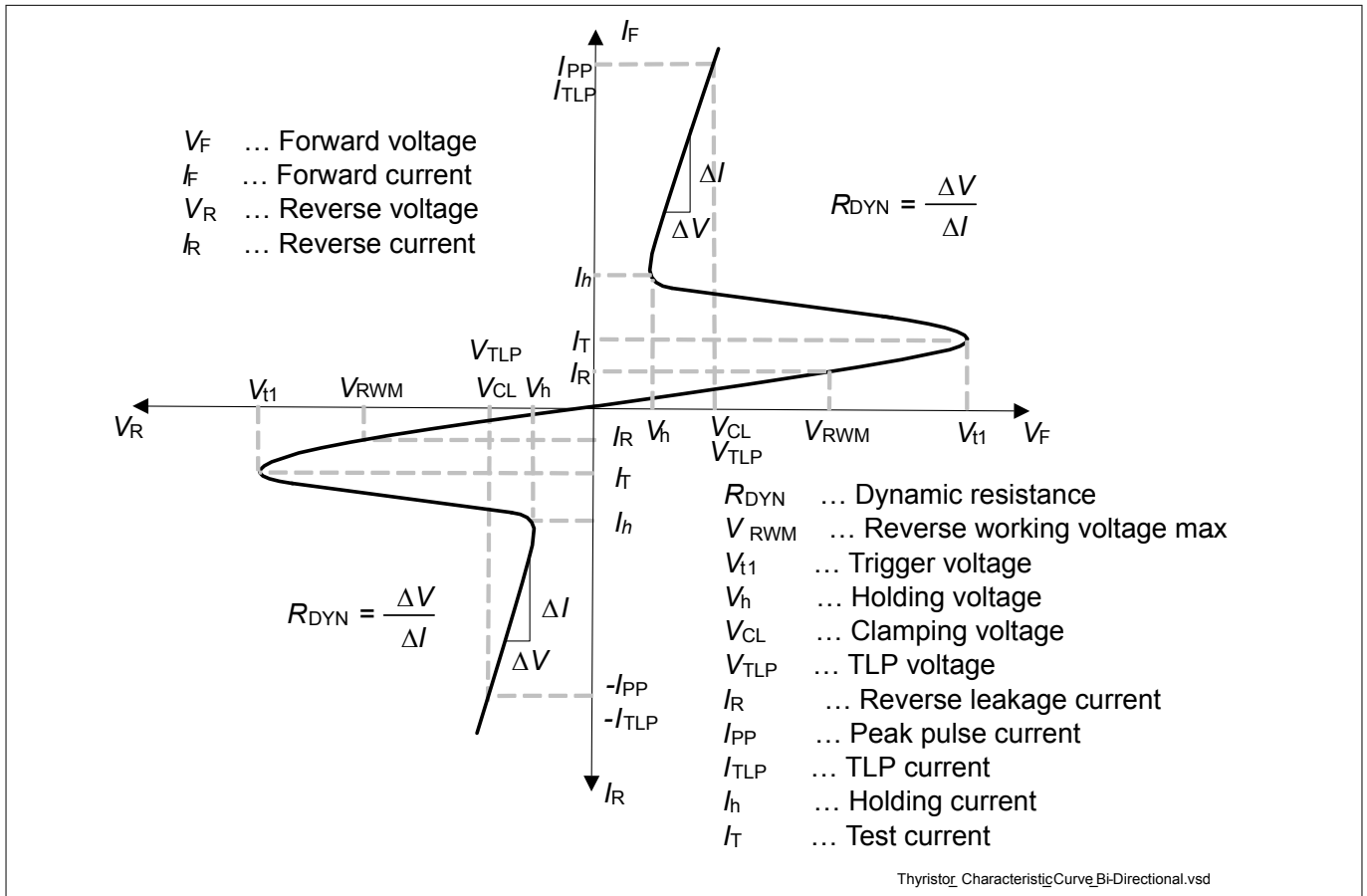

Figure 2 Definitions of electrical characteristics

Electrical characteristics

Table 3 DC characteristics ($T_A = 25\text{ °C}$, unless otherwise specified) ¹⁾

| Parameter | Symbol | Values | | | Unit | Note or test condition |
|-------------------------|----------|--------|------|------|------|------------------------|
| | | Min. | Typ. | Max. | | |
| Breakdown voltage | V_{br} | 6 | 8 | 10.5 | V | $I_R = 1\text{ mA}$ |
| Holding voltage | V_h | – | 1.9 | – | V | $I_R = I_h$ |
| Holding reverse current | I_h | – | 25 | – | mA | $V_R = V_h$ |
| Reverse current | I_R | – | – | 100 | nA | $V_R = 5.5\text{ V}$ |

Table 4 AC characteristics ($T_A = 25\text{ °C}$, unless otherwise specified)

| Parameter | Symbol | Values | | | Unit | Note or test condition |
|------------------|--------|--------|------|------|------|---|
| | | Min. | Typ. | Max. | | |
| Line capacitance | C_L | – | 0.23 | 0.35 | pF | $V_R = 0\text{ V}$, $f = 1\text{ MHz}$ |
| | | – | 0.20 | – | | $V_R = 0\text{ V}$, $f = 2.5\text{ GHz}$ |

Table 5 ESD and Surge characteristics ($T_A = 25\text{ °C}$, unless otherwise specified) ¹⁾

| Parameter | Symbol | Values | | | Unit | Note or test condition |
|----------------------------------|-----------|--------|------|------|----------|---|
| | | Min. | Typ. | Max. | | |
| Clamping voltage ²⁾ | V_{CL} | – | 8.5 | – | V | $I_{TLP} = 8\text{ A}$, $t_p = 100\text{ ns}$ |
| | | – | 13 | – | | $I_{TLP} = 16\text{ A}$, $t_p = 100\text{ ns}$ |
| Clamping voltage ³⁾ | | – | 3 | – | | $I_{PP} = 1\text{ A}$, $t_p = 8/20\text{ }\mu\text{s}$ |
| | | – | 5.5 | – | | $I_{PP} = 3\text{ A}$, $t_p = 8/20\text{ }\mu\text{s}$ |
| Dynamic resistance ²⁾ | R_{DYN} | – | 0.66 | – | Ω | $t_p = 100\text{ ns}$ |

¹ Device is electrically symmetrical

² Please refer to Application Note AN210 [1]. TLP parameters: $Z_0 = 50\text{ }\Omega$, $t_p = 100\text{ ns}$, $t_r = 0.6\text{ ns}$.

³ Stress pulse: 8/20 μs current waveform according to IEC61000-4-5

Typical characteristic diagrams

3 Typical characteristic diagrams

Note: $T_A = 25\text{ }^\circ\text{C}$, unless otherwise specified

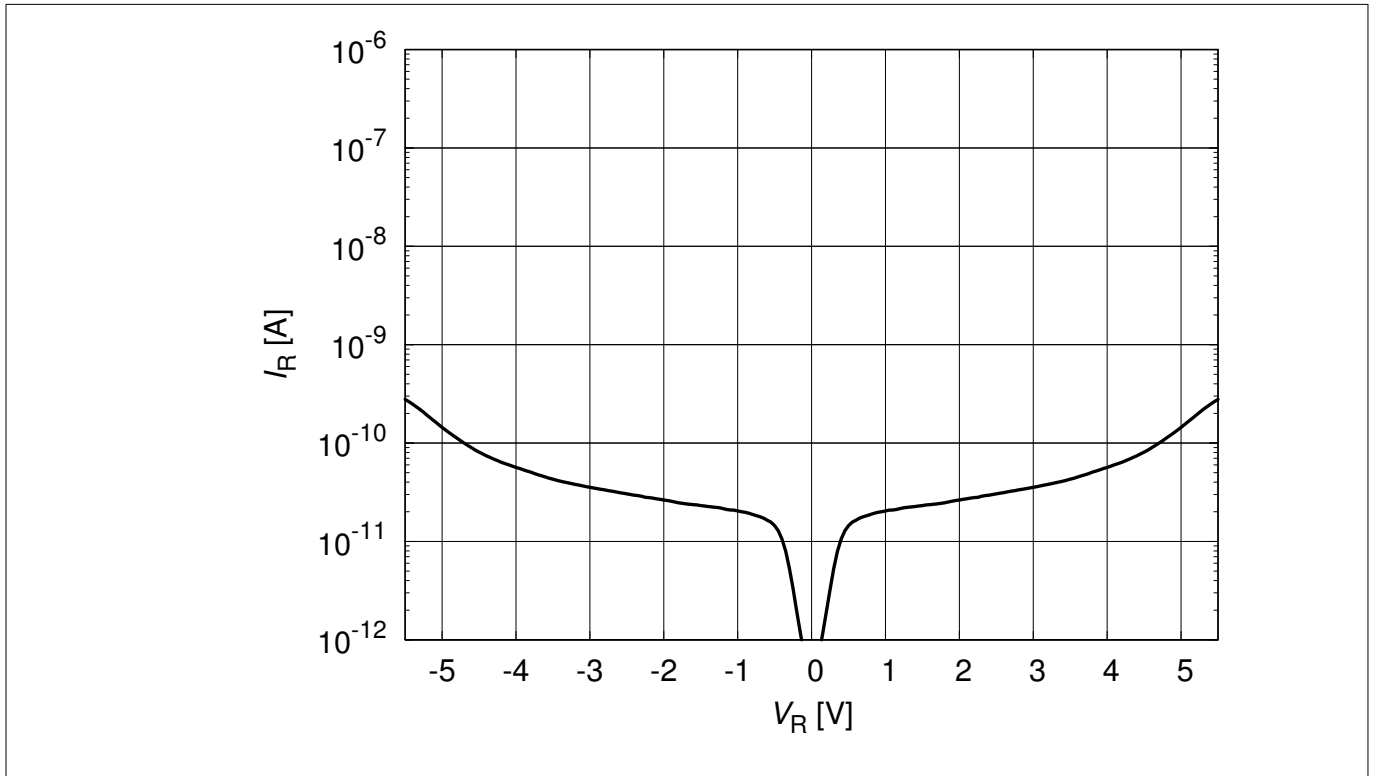

Figure 3 Reverse leakage current: $I_R = f(V_R)$

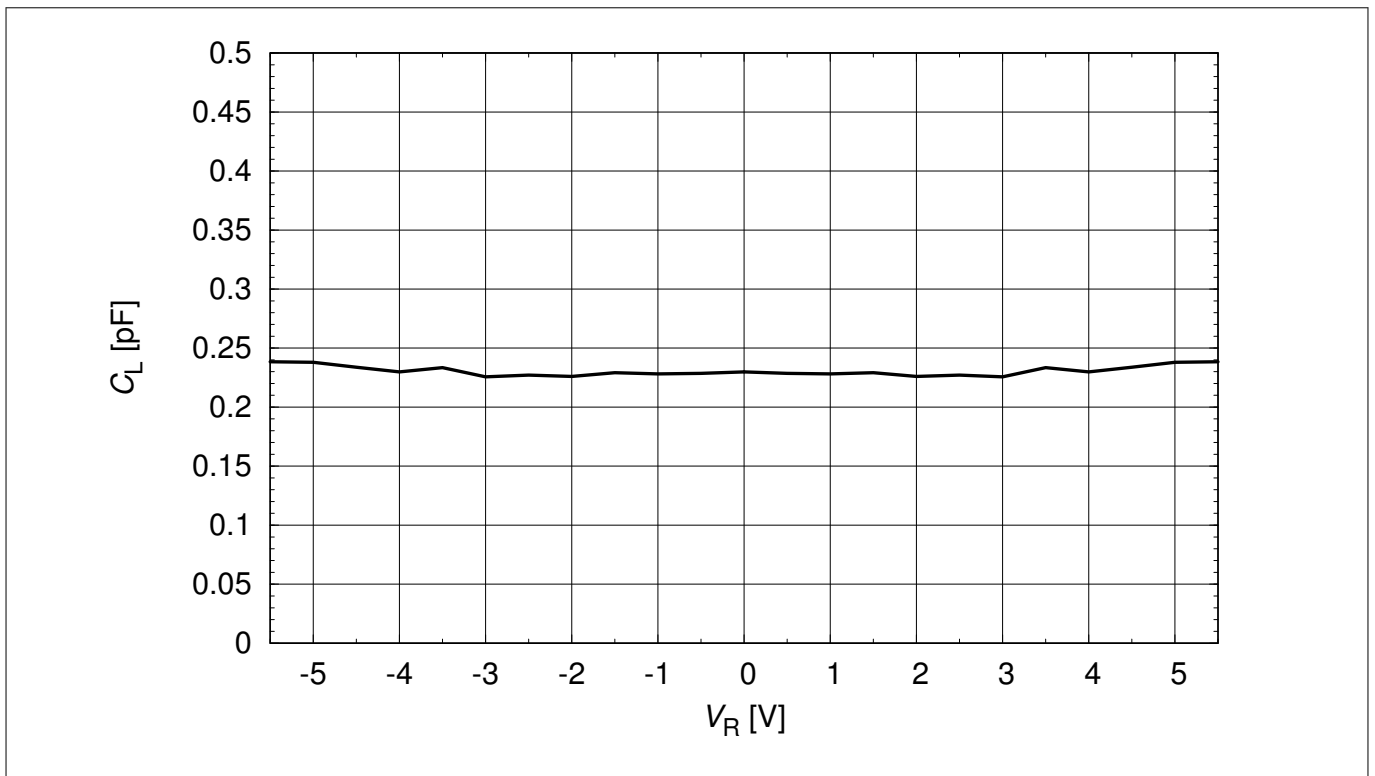

Figure 4 Line capacitance: $C_L = f(V_R)$, $f = 1\text{ MHz}$

Typical characteristic diagrams

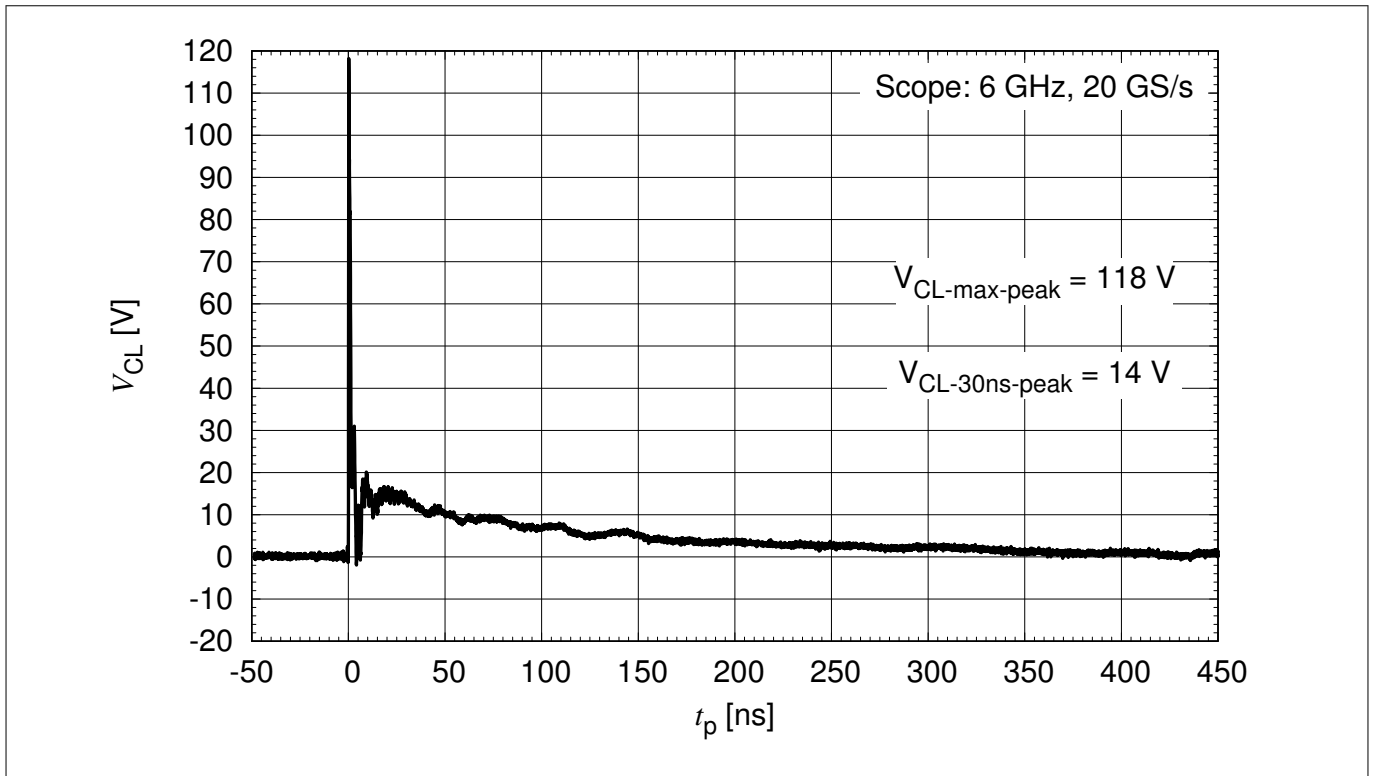

Figure 5 Clamping voltage (ESD): $V_{CL} = f(t)$, 8 kV positive pulse according to IEC61000-4-2

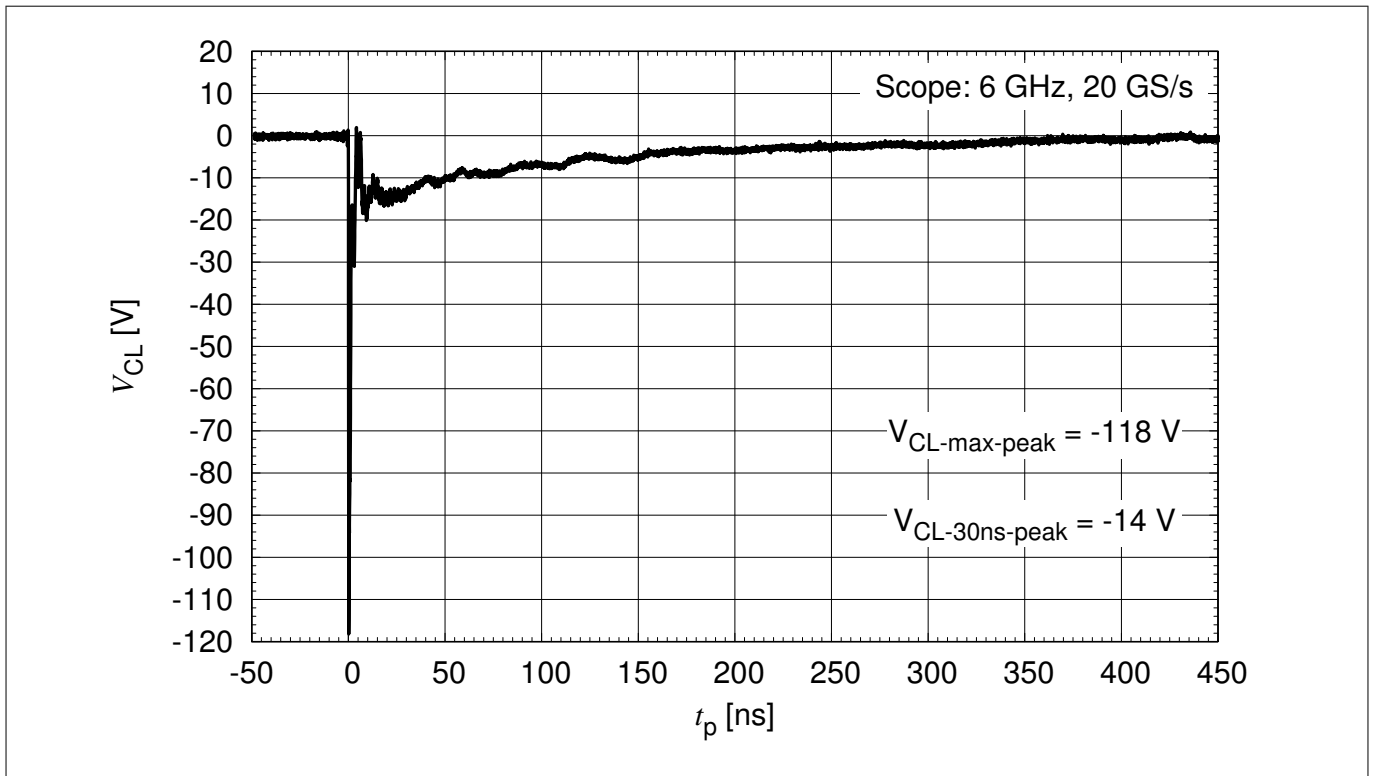

Figure 6 Clamping voltage (ESD): $V_{CL} = f(t)$, 8 kV negative pulse according to IEC61000-4-2

Typical characteristic diagrams

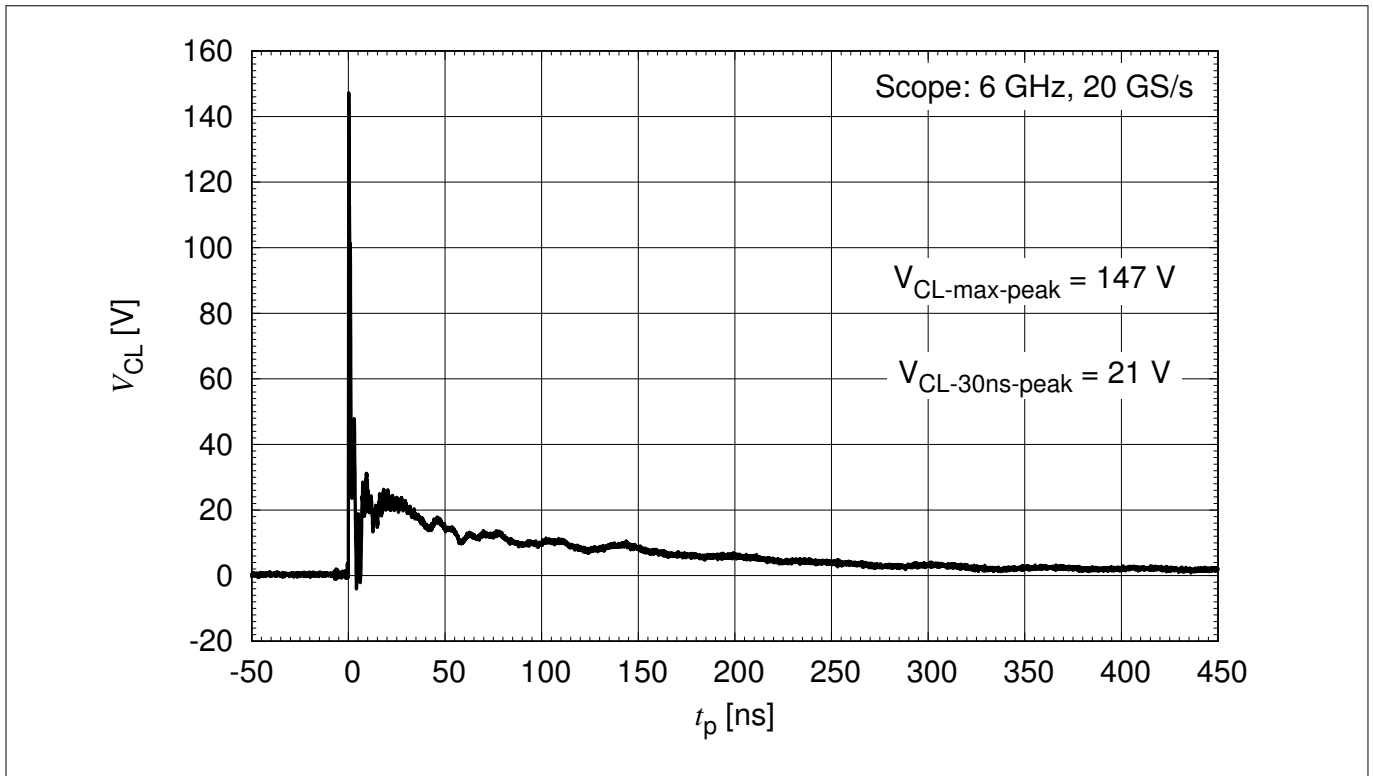

Figure 7 Clamping voltage (ESD): $V_{CL} = f(t)$, 15 kV positive pulse according to IEC61000-4-2

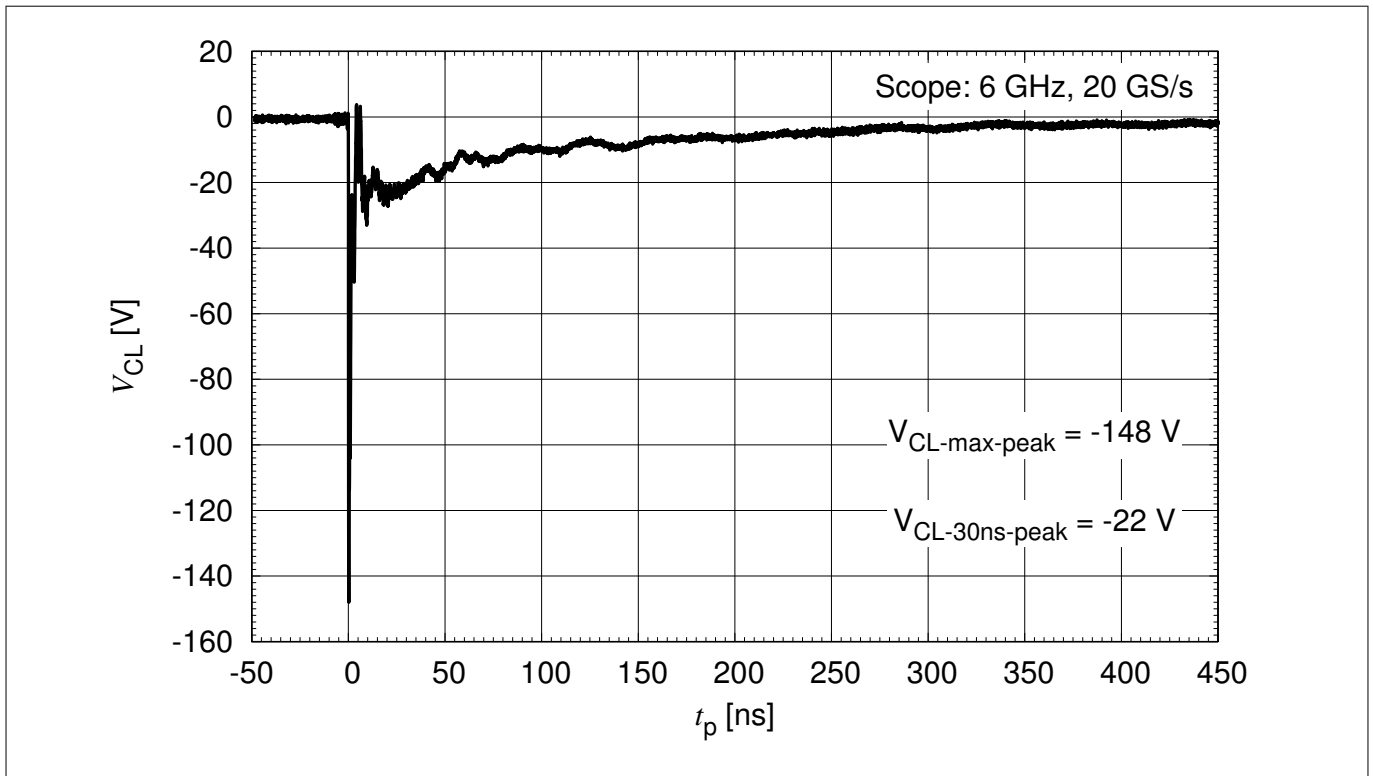

Figure 8 Clamping voltage (ESD): $V_{CL} = f(t)$, 15 kV negative pulse according to IEC61000-4-2

Typical characteristic diagrams

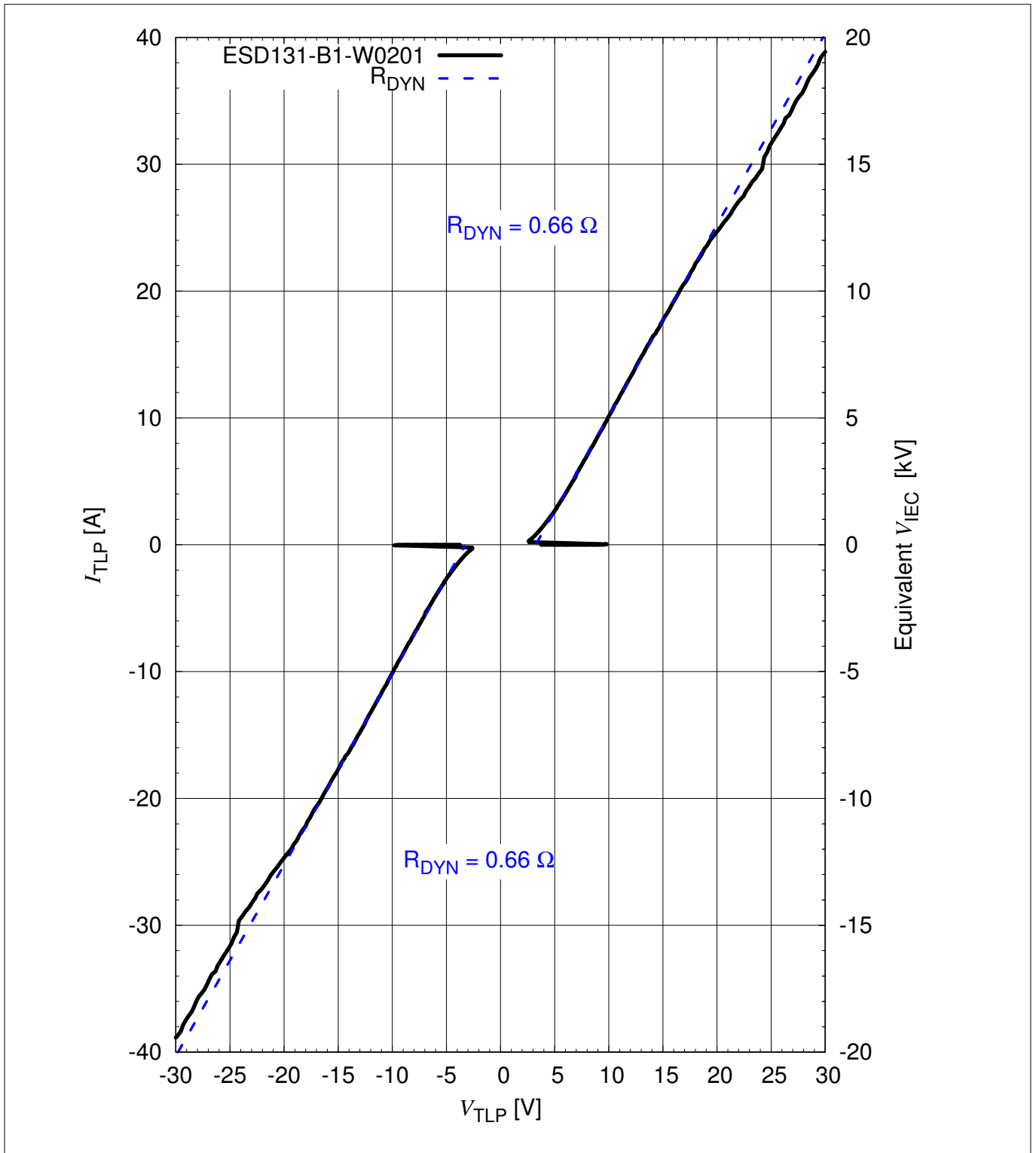

Figure 9 Clamping voltage (TLP): $I_{TLP} = f(V_{TLP})$ [1]

Typical characteristic diagrams

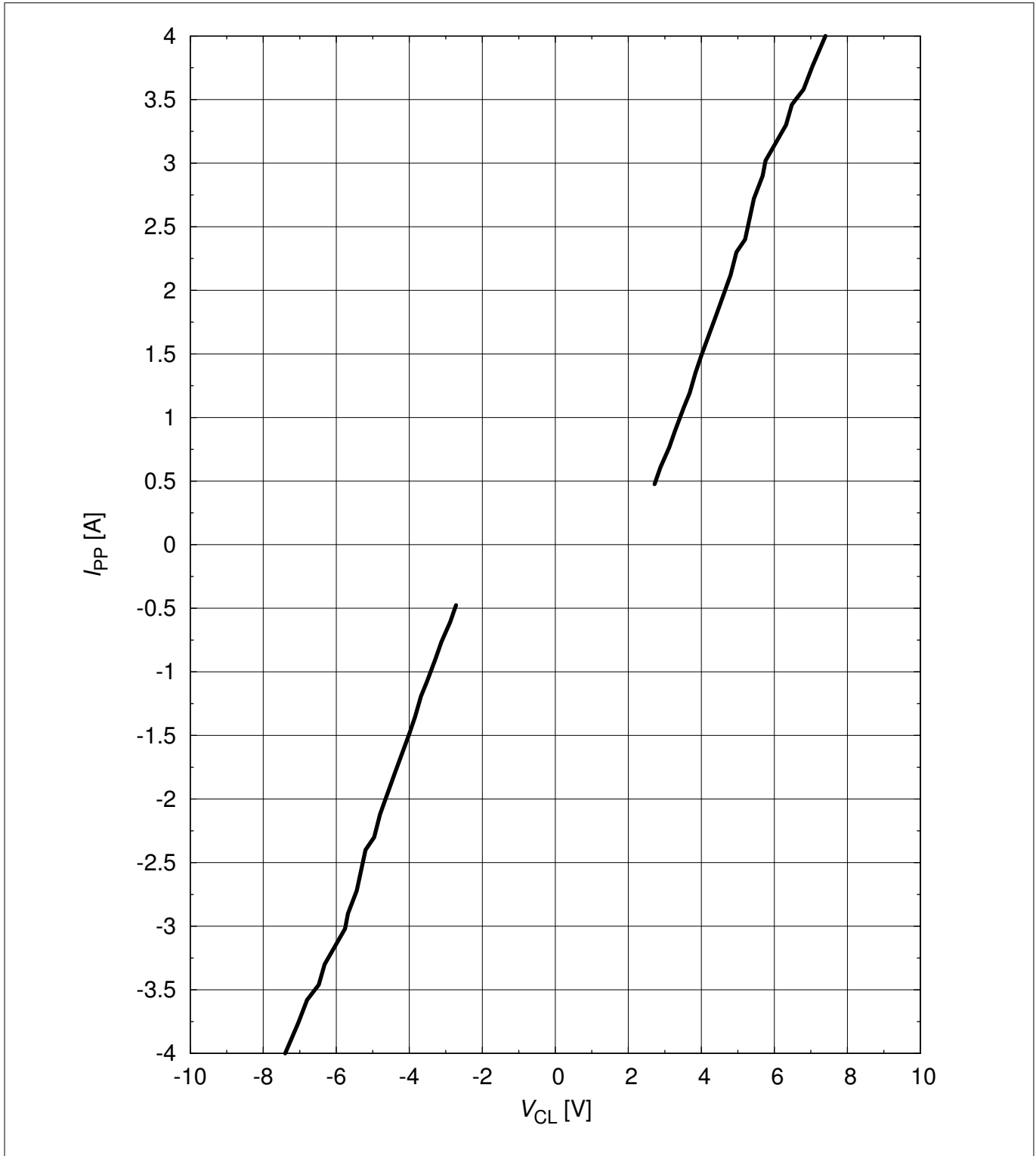

Figure 10 Clamping voltage (Surge): $I_{PP} = f(V_{CL})$ according to IEC61000-4-5 [1]

Typical characteristic diagrams

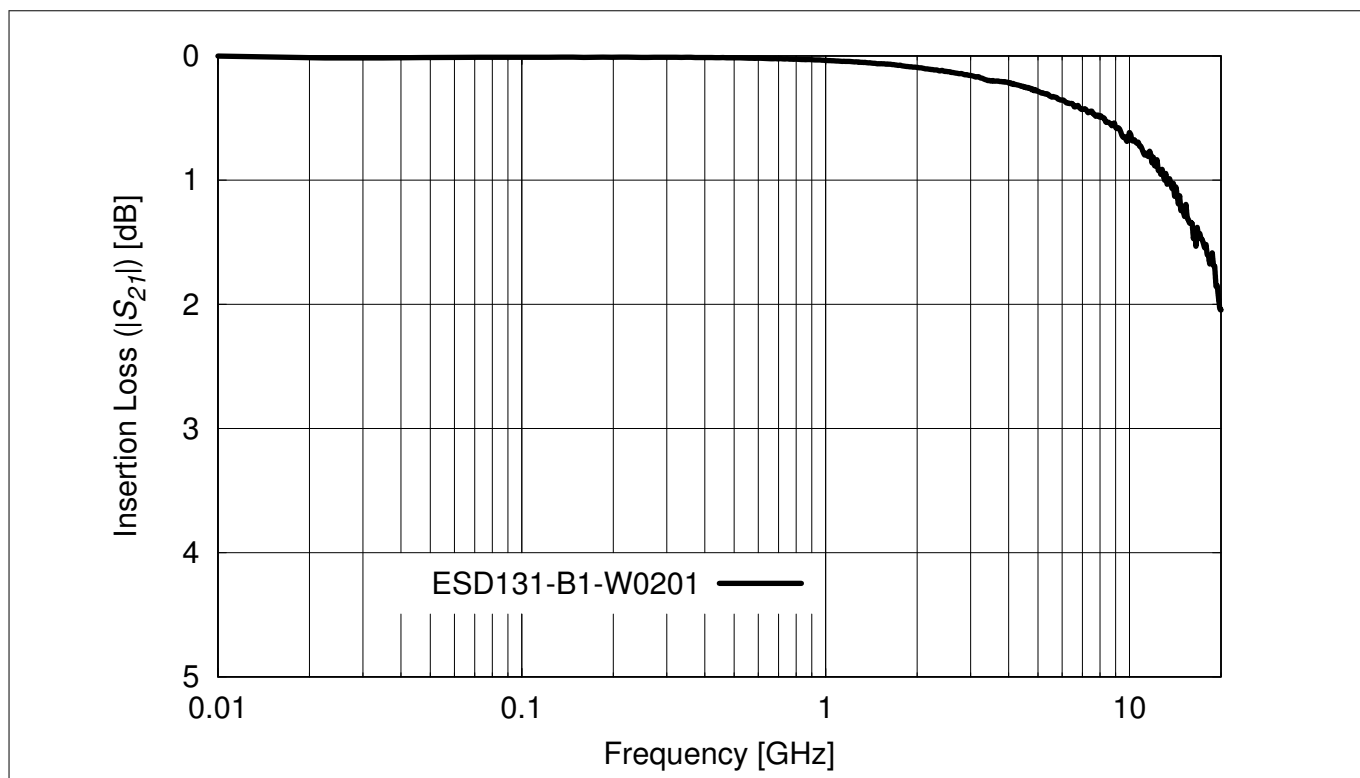

Figure 11 Insertion loss vs. frequency in a 50 Ω system

Package information

4 Package information

4.1 WLL-2-3 Package

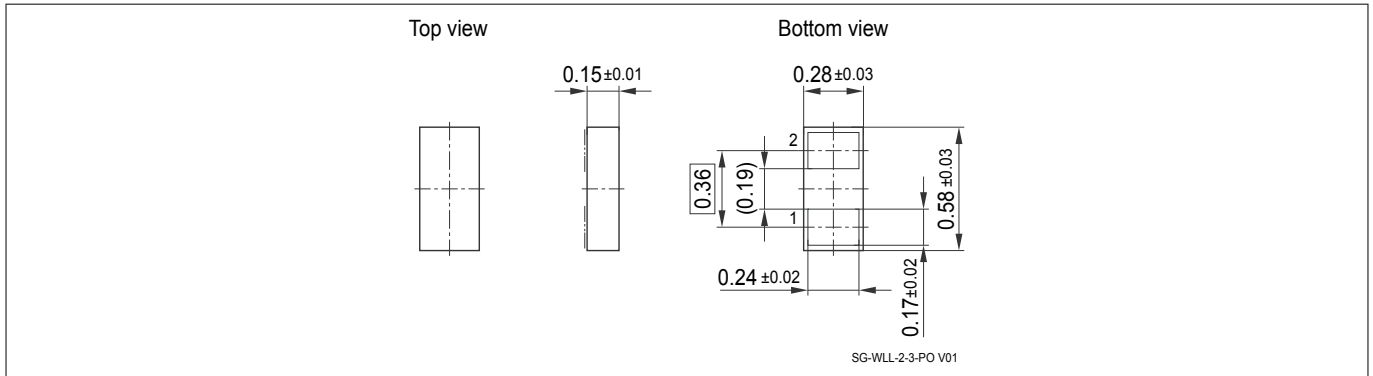

Figure 12 WLL-2-3 package outline (dimension in mm)

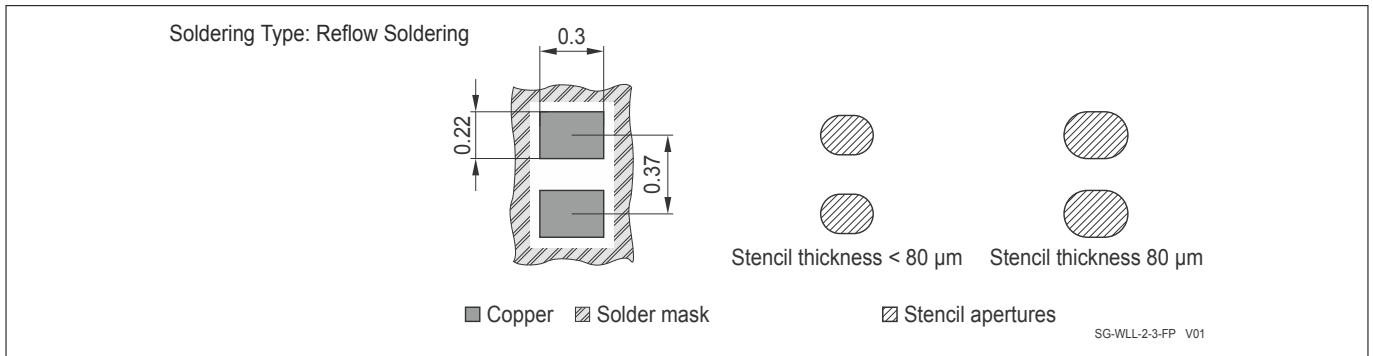

Figure 13 WLL-2-3 footprint (dimension in mm), recommendation for Printed Circuit Board Assembly see [2]

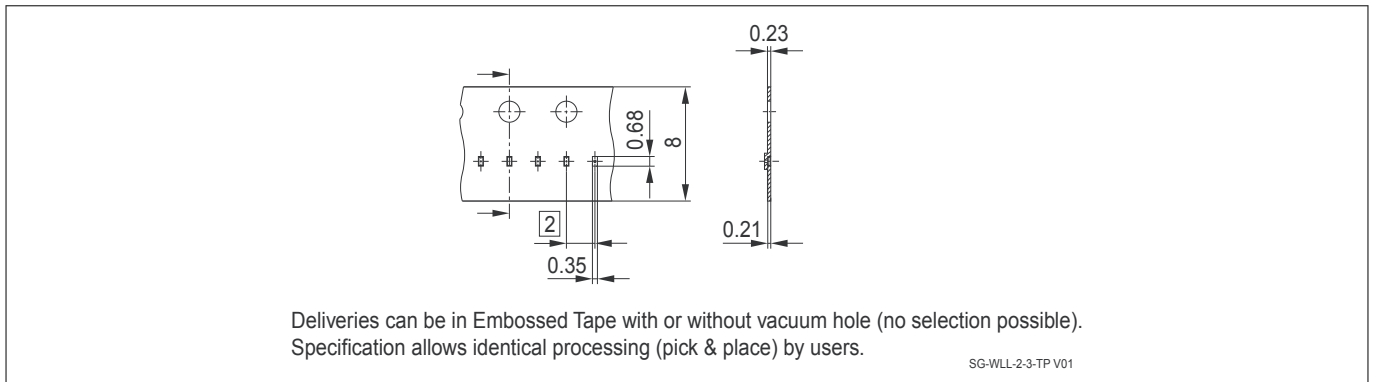

Figure 14 WLL-2-3 packing (dimension in mm)

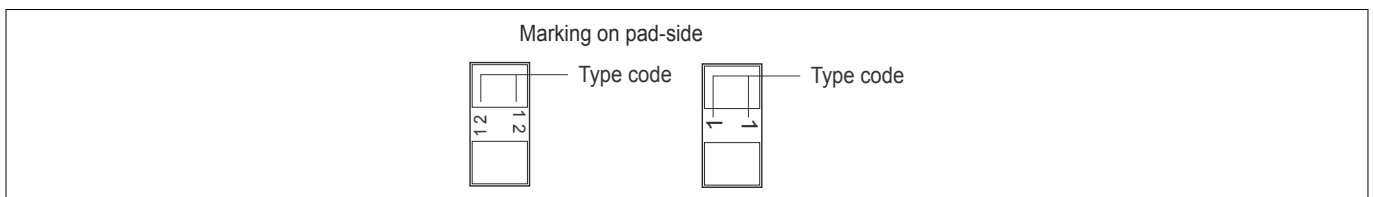

Figure 15 WLL-2-3 marking example (see Table 1)

References

5 References

- [1] Infineon AG - **Application Note AN210**: Effective ESD Protection design at System Level Using VF-TLP Characterization Methodology
- [2] Infineon AG - Recommendation for Printed Circuit Board Assembly of Infineon WLL Packages
http://www.infineon.com/Packageinformation_WLL
- [3] Infineon AG - **Application Note AN392**: TVS Diodes in ChipScalePackage reduce size and save cost

Revision history

Revision history: Rev.0.9, 2016-04-21

| Page or Item | Subjects (major changes since previous revision) |
|--------------------------|---|
| Revision 1.0, 2017-03-22 | |
| Tables 2, 3, 4 | Values updated |
| | Missing figures added |

Trademarks of Infineon Technologies AG

μ HVIC™, μ IPM™, μ PFC™, AU-ConvertIR™, AURIX™, C166™, CanPAK™, CIPOS™, CIPURSE™, CoolDP™, CoolGaN™, COOLiR™, CoolMOS™, CoolSET™, CoolSiC™, DAVE™, DI-POL™, DirectFET™, DrBlade™, EasyPIM™, EconoBRIDGE™, EconoDUAL™, EconoPACK™, EconoPIM™, EiceDRIVER™, eupec™, FCOS™, GaNpowIR™, HEXFET™, HITFET™, HybridPACK™, iMOTION™, IRAM™, ISOFACE™, IsoPACK™, LEDriviR™, LITIX™, MIPAQ™, ModSTACK™, my-d™, NovalithIC™, OPTIGA™, OptiMOS™, ORIGA™, PowIRaudio™, PowIRstage™, PrimePACK™, PrimeSTACK™, PROFET™, PRO-SIL™, RASIC™, REAL3™, SmartLEWIS™, SOLID FLASH™, SPOC™, StrongIRFET™, SuplIRBuck™, TEMPFET™, TRENCHSTOP™, TriCore™, UHVIC™, XHP™, XMC™.

Trademarks Update 2015-12-22

Other Trademarks

All referenced product or service names and trademarks are the property of their respective owners.

Edition 2017-03-27

Published by
Infineon Technologies AG
81726 Munich, Germany

© 2017 Infineon Technologies AG
All Rights Reserved.

Do you have a question about any aspect of this document?

Email: erratum@infineon.com

Document reference
IFX-jaj1475144300545

IMPORTANT NOTICE

The information given in this document shall in no event be regarded as a guarantee of conditions or characteristics ("Beschaffenhheitsgarantie").

With respect to any examples, hints or any typical values stated herein and/or any information regarding the application of the product, Infineon Technologies hereby disclaims any and all warranties and liabilities of any kind, including without limitation warranties of non-infringement of intellectual property rights of any third party.

In addition, any information given in this document is subject to customer's compliance with its obligations stated in this document and any applicable legal requirements, norms and standards concerning customer's products and any use of the product of Infineon Technologies in customer's applications.

The data contained in this document is exclusively intended for technically trained staff. It is the responsibility of customer's technical departments to evaluate the suitability of the product for the intended application and the completeness of the product information given in this document with respect to such application.

WARNINGS

Due to technical requirements products may contain dangerous substances. For information on the types in question please contact your nearest Infineon Technologies office.

Except as otherwise explicitly approved by Infineon Technologies in a written document signed by authorized representatives of Infineon Technologies, Infineon Technologies' products may not be used in any applications where a failure of the product or any consequences of the use thereof can reasonably be expected to result in personal injury



Компания «ЭлектроПласт» предлагает заключение долгосрочных отношений при поставках импортных электронных компонентов на взаимовыгодных условиях!

Наши преимущества:

- Оперативные поставки широкого спектра электронных компонентов отечественного и импортного производства напрямую от производителей и с крупнейших мировых складов;
- Поставка более 17-ти миллионов наименований электронных компонентов;
- Поставка сложных, дефицитных, либо снятых с производства позиций;
- Оперативные сроки поставки под заказ (от 5 рабочих дней);
- Экспресс доставка в любую точку России;
- Техническая поддержка проекта, помощь в подборе аналогов, поставка прототипов;
- Система менеджмента качества сертифицирована по Международному стандарту ISO 9001;
- Лицензия ФСБ на осуществление работ с использованием сведений, составляющих государственную тайну;
- Поставка специализированных компонентов (Xilinx, Altera, Analog Devices, Intersil, Interpoint, Microsemi, Aeroflex, Peregrine, Syfer, Eurofarad, Texas Instrument, Miteq, Cobham, E2V, MA-COM, Hittite, Mini-Circuits, General Dynamics и др.);

Помимо этого, одним из направлений компании «ЭлектроПласт» является направление «Источники питания». Мы предлагаем Вам помощь Конструкторского отдела:

- Подбор оптимального решения, техническое обоснование при выборе компонента;
- Подбор аналогов;
- Консультации по применению компонента;
- Поставка образцов и прототипов;
- Техническая поддержка проекта;
- Защита от снятия компонента с производства.



Как с нами связаться

Телефон: 8 (812) 309 58 32 (многоканальный)

Факс: 8 (812) 320-02-42

Электронная почта: org@eplast1.ru

Адрес: 198099, г. Санкт-Петербург, ул. Калинина, дом 2, корпус 4, литера А.