

## N-channel 100 V, 0.0036 $\Omega$ typ., 110 A, STripFET™ F7 Power MOSFETs in I<sup>2</sup>PAK and TO-220 packages

Datasheet – production data

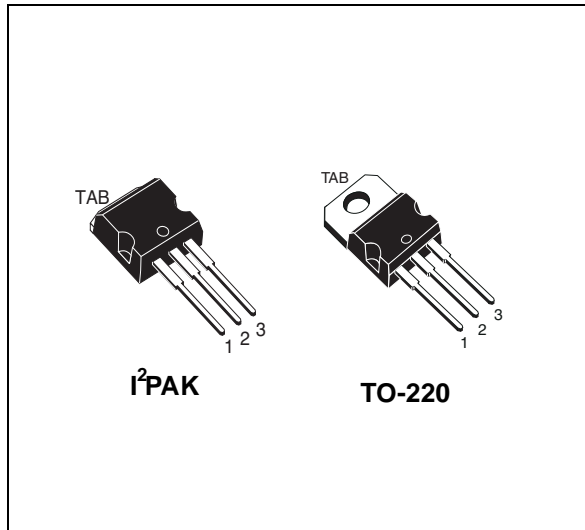
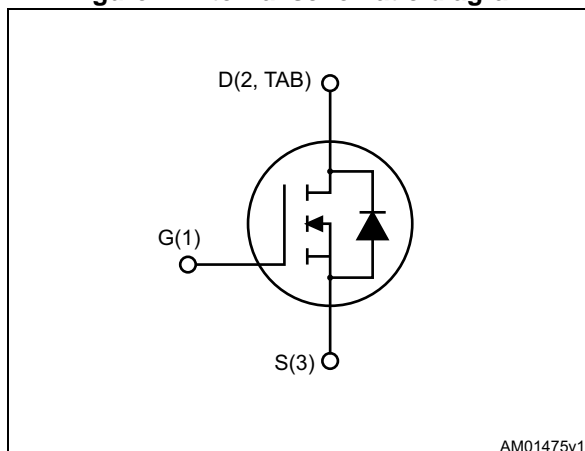

Figure 1. Internal schematic diagram



### Features

Order codes	V <sub>DS</sub>	R <sub>DS(on)max</sub>	I <sub>D</sub>	P <sub>TOT</sub>
STI150N10F7	100 V	0.0042 $\Omega$	110 A	250 W
STP150N10F7				

- Among the lowest R<sub>DS(on)</sub> on the market
- Excellent figure of merit (FoM)
- Low Crss/Ciss ratio for EMI immunity
- High avalanche ruggedness

### Applications

- Switching applications

### Description

These N-channel Power MOSFETs utilize STripFET™ F7 technology with an enhanced trench gate structure that results in very low on-state resistance, while also reducing internal capacitance and gate charge for faster and more efficient switching.

Table 1. Device summary

Order codes	Marking	Package	Packaging
STI150N10F7	150N10F7	I <sup>2</sup> PAK	Tube
STP150N10F7		TO-220	

# Contents

<b>1</b>	<b>Electrical ratings</b> .....	<b>3</b>
<b>2</b>	<b>Electrical characteristics</b> .....	<b>4</b>
	2.1 Electrical characteristics (curves) .....	6
<b>3</b>	<b>Test circuits</b> .....	<b>8</b>
<b>4</b>	<b>Package mechanical data</b> .....	<b>9</b>
<b>5</b>	<b>Revision history</b> .....	<b>14</b>

# 1 Electrical ratings

**Table 2. Absolute maximum ratings**

Symbol	Parameter	Value	Unit
$V_{DS}$	Drain-source voltage	100	V
$V_{GS}$	Gate- source voltage	$\pm 20$	V
$I_D$	Drain current (continuous) at $T_C = 25\text{ }^\circ\text{C}$	110	A
$I_D$	Drain current (continuous) at $T_C = 100\text{ }^\circ\text{C}$	110	A
$I_{DM}^{(1)}$	Drain current (pulsed)	440	A
$P_{TOT}$	Total dissipation at $T_C = 25\text{ }^\circ\text{C}$	250	W
$E_{AS}^{(2)}$	Single pulse avalanche energy	495	mJ
$T_J$	Operating junction temperature	-55 to 175	$^\circ\text{C}$
$T_{stg}$	Storage temperature		$^\circ\text{C}$

1. Pulse width is limited by safe operating area

2. Starting  $T_j=25\text{ }^\circ\text{C}$ ,  $I_D=30\text{ A}$ ,  $V_{DD}=50\text{ V}$

**Table 3. Thermal data**

Symbol	Parameter	Value	Unit
$R_{thj-case}$	Thermal resistance junction-case max	0.6	$^\circ\text{C/W}$
$R_{thj-amb}$	Thermal resistance junction-ambient max	62.5	$^\circ\text{C/W}$

## 2 Electrical characteristics

( $T_C = 25\text{ °C}$  unless otherwise specified)

**Table 4. On /off states**

Symbol	Parameter	Test conditions	Min.	Typ.	Max.	Unit
$V_{(BR)DSS}$	Drain-source breakdown voltage	$V_{GS} = 0, I_D = 250\ \mu A$	100			V
$I_{DSS}$	Zero gate voltage drain current	$V_{GS} = 0, V_{DS} = 100\ V$			1	$\mu A$
		$V_{GS} = 0, V_{DS} = 100\ V, T_C = 125\text{ °C}$			100	$\mu A$
$I_{GSS}$	Gate-body leakage current	$V_{DS} = 0, V_{GS} = +20\ V$			100	nA
$V_{GS(th)}$	Gate threshold voltage	$V_{DS} = V_{GS}, I_D = 250\ \mu A$	2.5		4.5	V
$R_{DS(on)}$	Static drain-source on-resistance	$V_{GS} = 10\ V, I_D = 55\ A$		0.0036	0.0042	$\Omega$

**Table 5. Dynamic**

Symbol	Parameter	Test conditions	Min.	Typ.	Max.	Unit
$C_{iss}$	Input capacitance	$V_{DS} = 50\ V, f = 1\ MHz, V_{GS} = 0$	-	8115	-	pF
$C_{oss}$	Output capacitance		-	1510	-	pF
$C_{riss}$	Reverse transfer capacitance		-	67	-	pF
$Q_g$	Total gate charge	$V_{DD} = 50\ V, I_D = 110\ A, V_{GS} = 10\ V$ (see <a href="#">Figure 14</a> )	-	117	-	nC
$Q_{gs}$	Gate-source charge		-	47	-	nC
$Q_{gd}$	Gate-drain charge		-	26	-	nC

**Table 6. Switching times**

Symbol	Parameter	Test conditions	Min.	Typ.	Max.	Unit
$t_{d(on)}$	Turn-on delay time	$V_{DD} = 50\ V, I_D = 55\ A, R_G = 4.7\ \Omega, V_{GS} = 10\ V$ (see <a href="#">Figure 13</a> )	-	33	-	ns
$t_r$	Rise time		-	57	-	ns
$t_{d(off)}$	Turn-off delay time		-	72	-	ns
$t_f$	Fall time		-	33	-	ns

Table 7. Source drain diode

Symbol	Parameter	Test conditions	Min.	Typ.	Max.	Unit
$I_{SD}$	Source-drain current		-		110	A
$I_{SDM}^{(1)}$	Source-drain current (pulsed)		-		440	A
$V_{SD}^{(2)}$	Forward on voltage	$I_{SD} = 110 \text{ A}$ , $V_{GS} = 0$	-		1.2	V
$t_{rr}$	Reverse recovery time	$I_{SD} = 110 \text{ A}$ , $di/dt = 100 \text{ A}/\mu\text{s}$ $V_{DD} = 80 \text{ V}$ , $T_J = 150 \text{ }^\circ\text{C}$ (see <a href="#">Figure 15</a> )	-	70		ns
$Q_{rr}$	Reverse recovery charge		-	165		nC
$I_{RRM}$	Reverse recovery current		-	4.7		A

1. Pulse width limited by safe operating area
2. Pulsed: pulse duration = 300  $\mu\text{s}$ , duty cycle 1.5%.

## 2.1 Electrical characteristics (curves)

Figure 2. Safe operating area

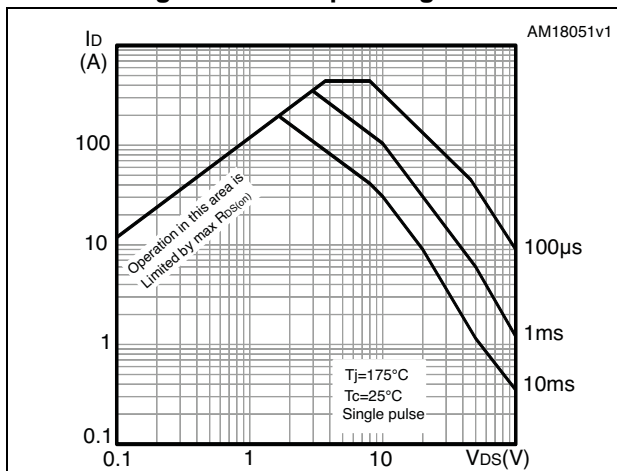

Figure 3. Thermal impedance

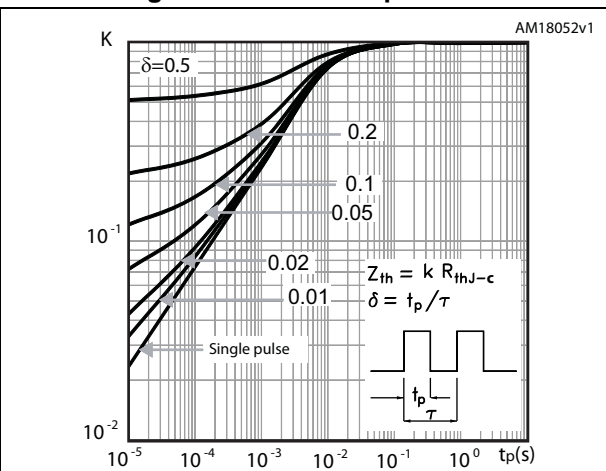

Figure 4. Output characteristics

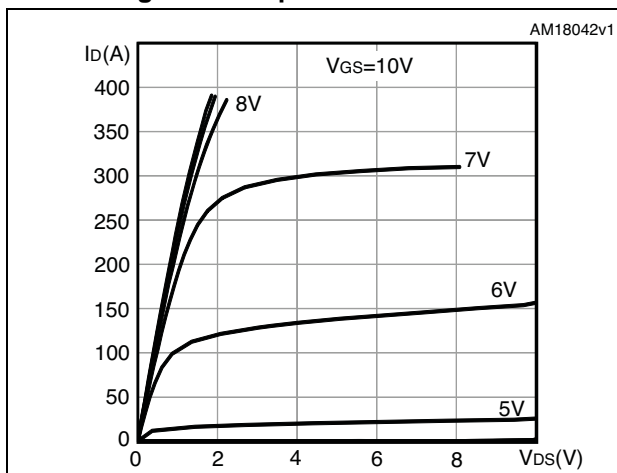

Figure 5. Transfer characteristics

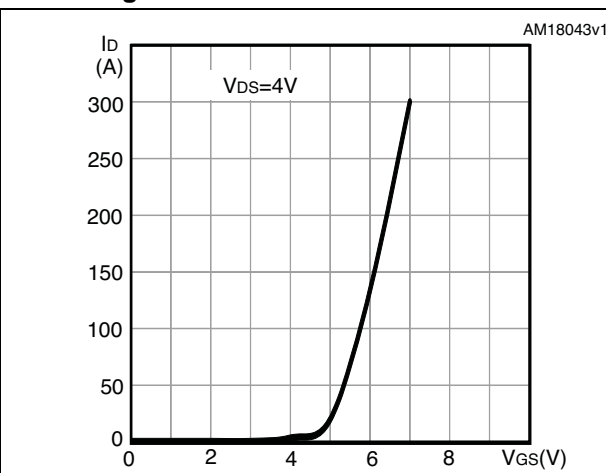

Figure 6. Gate charge vs gate-source voltage

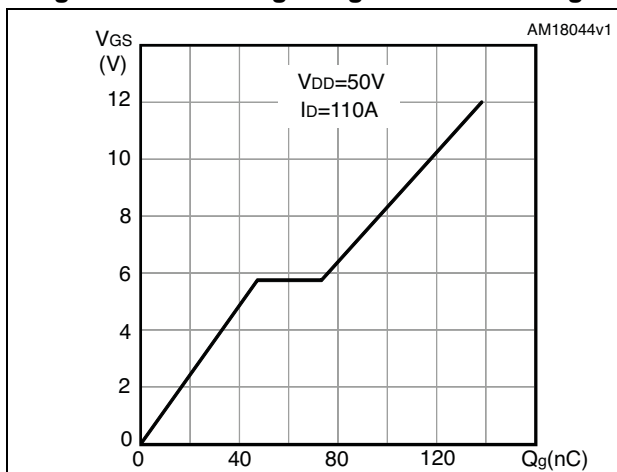

Figure 7. Static drain-source on-resistance

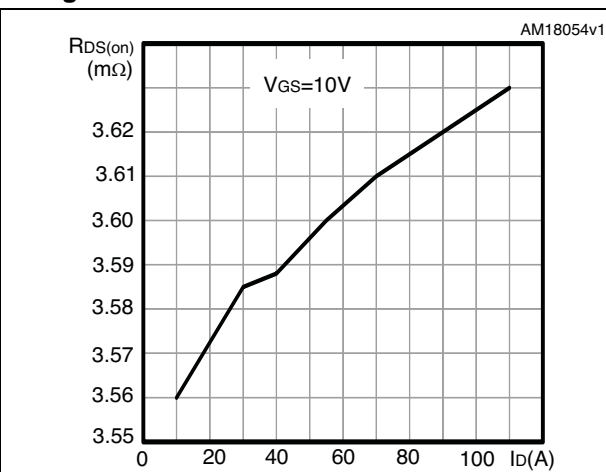

Figure 8. Capacitance variations

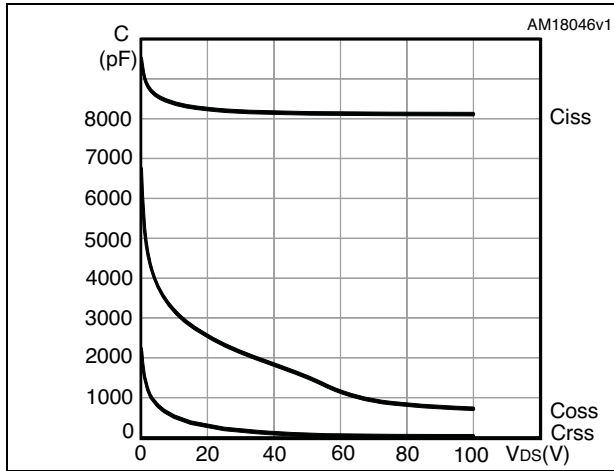

Figure 9. Normalized gate threshold voltage vs temperature

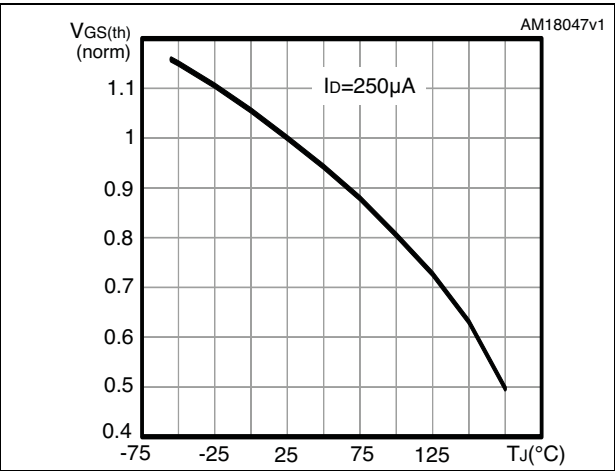

Figure 10. Normalized on-resistance vs temperature

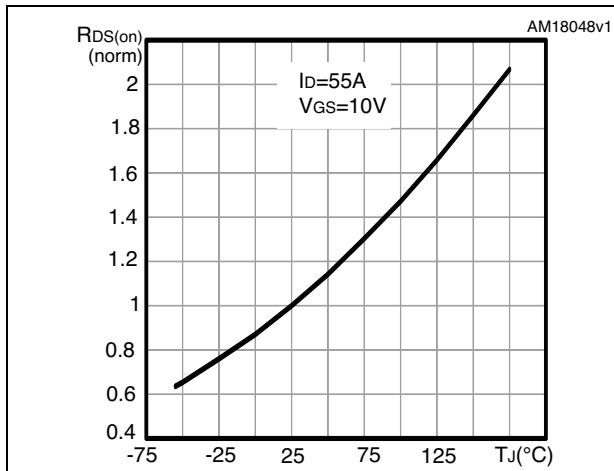

Figure 11. Normalized  $V_{(BR)DSS}$  vs temperature

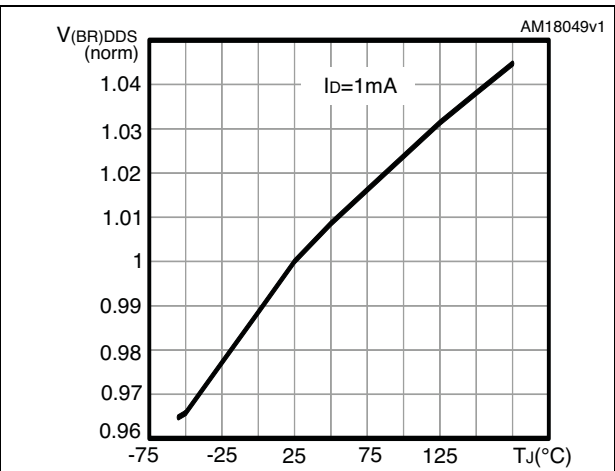
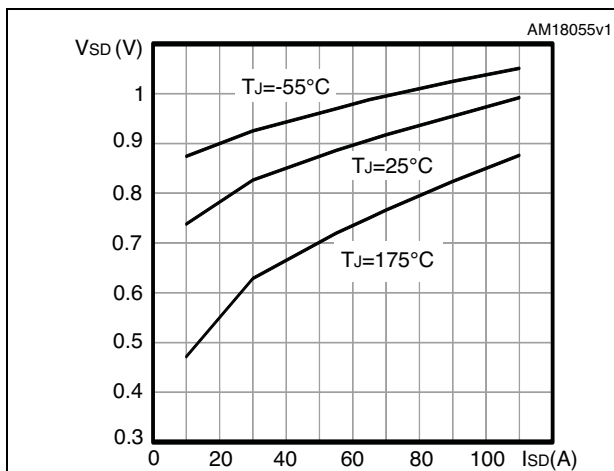

Figure 12. Source-drain diode forward characteristics



### 3 Test circuits

Figure 13. Switching times test circuit for resistive load



Figure 14. Gate charge test circuit



Figure 15. Test circuit for inductive load switching and diode recovery times



Figure 16. Unclamped inductive load test circuit



Figure 17. Unclamped inductive waveform



Figure 18. Switching time waveform





## 4 Package mechanical data

In order to meet environmental requirements, ST offers these devices in different grades of ECOPACK<sup>®</sup> packages, depending on their level of environmental compliance. ECOPACK<sup>®</sup> specifications, grade definitions and product status are available at: [www.st.com](http://www.st.com). ECOPACK<sup>®</sup> is an ST trademark.

Figure 19. I<sup>2</sup>PAK (TO-262) drawing

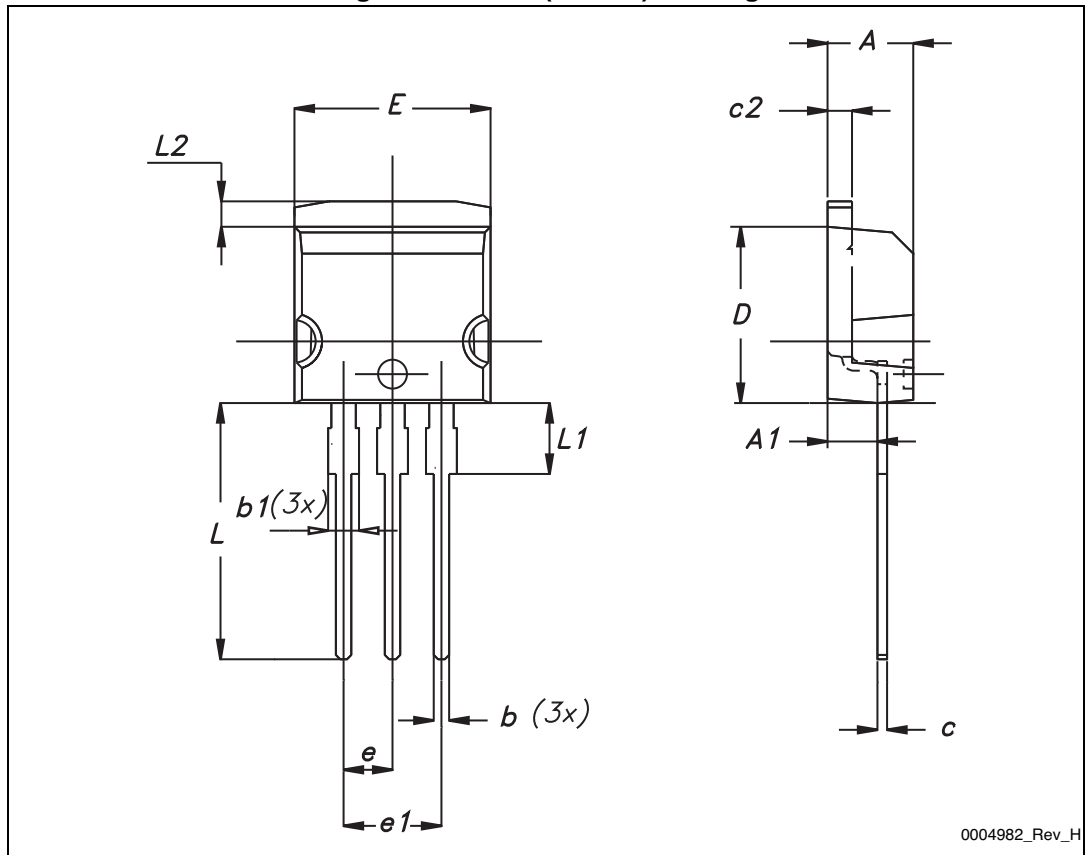

0004982\_Rev\_H

Table 8. I<sup>2</sup>PAK (TO-262) mechanical data

DIM.	mm.		
	min.	typ	max.
A	4.40		4.60
A1	2.40		2.72
b	0.61		0.88
b1	1.14		1.70
c	0.49		0.70
c2	1.23		1.32
D	8.95		9.35
e	2.40		2.70
e1	4.95		5.15
E	10		10.40
L	13		14
L1	3.50		3.93
L2	1.27		1.40

Figure 20. TO-220 type A drawing

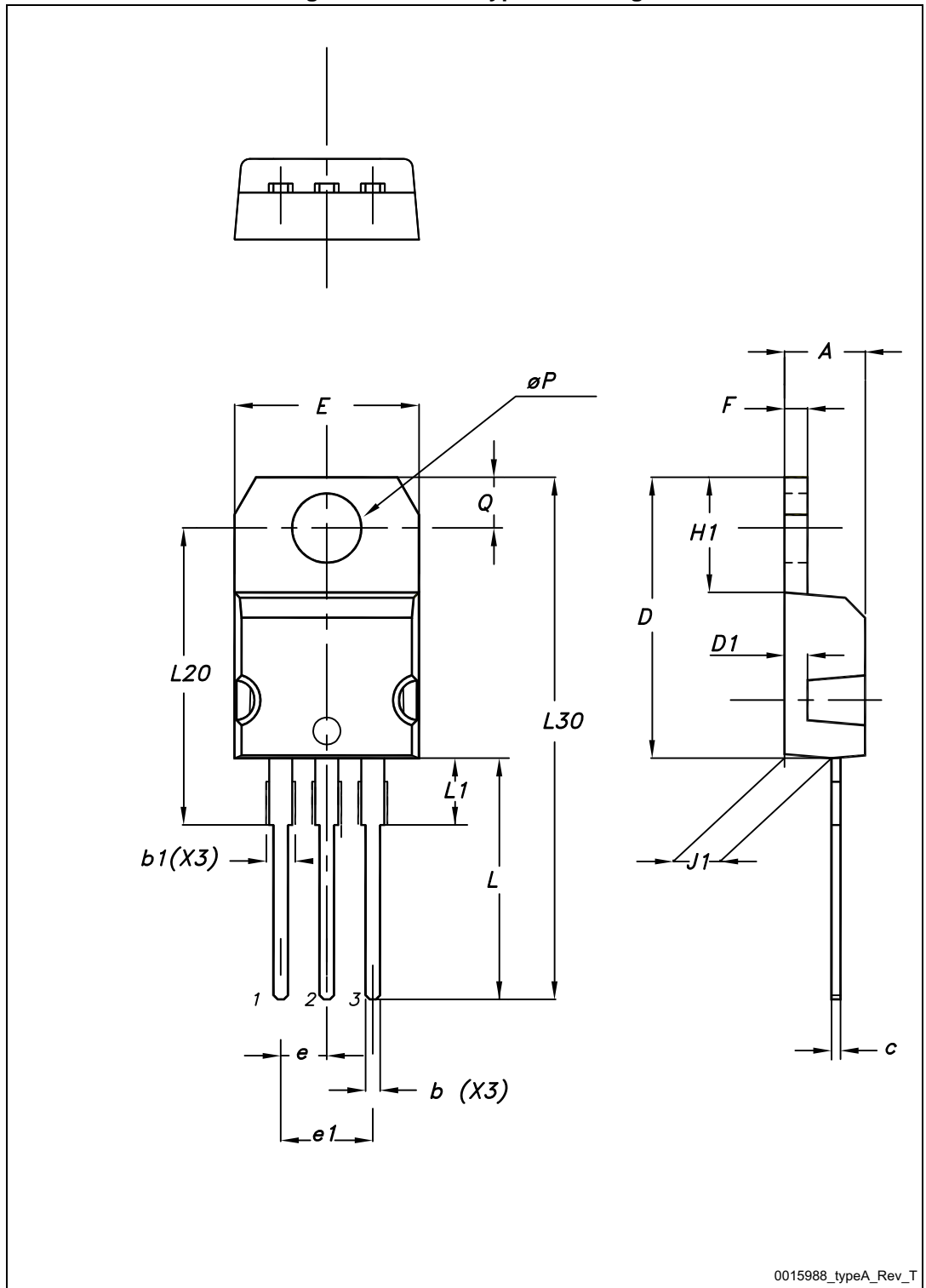

Table 9. TO-220 type A mechanical data

Dim.	mm		
	Min.	Typ.	Max.
A	4.40		4.60
b	0.61		0.88
b1	1.14		1.70
c	0.48		0.70
D	15.25		15.75
D1		1.27	
E	10		10.40
e	2.40		2.70
e1	4.95		5.15
F	1.23		1.32
H1	6.20		6.60
J1	2.40		2.72
L	13		14
L1	3.50		3.93
L20		16.40	
L30		28.90	
∅P	3.75		3.85
Q	2.65		2.95

## 5 Revision history

**Table 10. Document revision history**

Date	Revision	Changes
16-Apr-2013	1	First release.
22-Jan-2014	2	<ul style="list-style-type: none"> <li>– The part number STH150N10F7-2 has been moved to a separate datasheet</li> <li>– Added: I<sup>2</sup>PAK package</li> <li>– Modified: <a href="#">Figure 1</a></li> <li>– Modified: I<sub>D</sub> and I<sub>DM</sub> values in <a href="#">Table 2</a></li> <li>– Modified: R<sub>thj-case</sub> value in <a href="#">Table 3</a></li> <li>– Modified: R<sub>DS(on)</sub> values in <a href="#">Table 4</a></li> <li>– Modified: V<sub>SD</sub>, I<sub>D</sub> and the entire typical values in <a href="#">Table 5</a>, <a href="#">6</a> and <a href="#">7</a></li> <li>– Updated: <a href="#">Figure 13</a>, <a href="#">14</a>, <a href="#">15</a> and <a href="#">16</a></li> <li>– Updated: <a href="#">Section 4: Package mechanical data</a></li> <li>– Added: <a href="#">Section 2.1: Electrical characteristics (curves)</a></li> <li>– Minor text changes</li> </ul>
24-Feb-2014	3	<ul style="list-style-type: none"> <li>– Datasheet status promoted from preliminary data to production data</li> <li>– Modified: <a href="#">Figure 10</a></li> <li>– Minor text changes</li> </ul>
20-Aug-2014		<ul style="list-style-type: none"> <li>– Updated title, features and description in cover page.</li> <li>– Added E<sub>AS</sub> parameter in <a href="#">Table 2: Absolute maximum ratings</a>.</li> <li>– Minor text changes</li> </ul>

**IMPORTANT NOTICE – PLEASE READ CAREFULLY**

STMicroelectronics NV and its subsidiaries (“ST”) reserve the right to make changes, corrections, enhancements, modifications, and improvements to ST products and/or to this document at any time without notice. Purchasers should obtain the latest relevant information on ST products before placing orders. ST products are sold pursuant to ST’s terms and conditions of sale in place at the time of order acknowledgement.

Purchasers are solely responsible for the choice, selection, and use of ST products and ST assumes no liability for application assistance or the design of Purchasers’ products.

No license, express or implied, to any intellectual property right is granted by ST herein.

Resale of ST products with provisions different from the information set forth herein shall void any warranty granted by ST for such product.

ST and the ST logo are trademarks of ST. All other product or service names are the property of their respective owners.

Information in this document supersedes and replaces information previously supplied in any prior versions of this document.

© 2014 STMicroelectronics – All rights reserved



Компания «ЭлектроПласт» предлагает заключение долгосрочных отношений при поставках импортных электронных компонентов на взаимовыгодных условиях!

Наши преимущества:

- Оперативные поставки широкого спектра электронных компонентов отечественного и импортного производства напрямую от производителей и с крупнейших мировых складов;
- Поставка более 17-ти миллионов наименований электронных компонентов;
- Поставка сложных, дефицитных, либо снятых с производства позиций;
- Оперативные сроки поставки под заказ (от 5 рабочих дней);
- Экспресс доставка в любую точку России;
- Техническая поддержка проекта, помощь в подборе аналогов, поставка прототипов;
- Система менеджмента качества сертифицирована по Международному стандарту ISO 9001;
- Лицензия ФСБ на осуществление работ с использованием сведений, составляющих государственную тайну;
- Поставка специализированных компонентов (Xilinx, Altera, Analog Devices, Intersil, Interpoint, Microsemi, Aeroflex, Peregrine, Syfer, Eurofarad, Texas Instrument, Miteq, Cobham, E2V, MA-COM, Hittite, Mini-Circuits, General Dynamics и др.);

Помимо этого, одним из направлений компании «ЭлектроПласт» является направление «Источники питания». Мы предлагаем Вам помощь Конструкторского отдела:

- Подбор оптимального решения, техническое обоснование при выборе компонента;
- Подбор аналогов;
- Консультации по применению компонента;
- Поставка образцов и прототипов;
- Техническая поддержка проекта;
- Защита от снятия компонента с производства.



#### Как с нами связаться

**Телефон:** 8 (812) 309 58 32 (многоканальный)

**Факс:** 8 (812) 320-02-42

**Электронная почта:** [org@eplast1.ru](mailto:org@eplast1.ru)

**Адрес:** 198099, г. Санкт-Петербург, ул. Калинина, дом 2, корпус 4, литера А.