

DATA SHEET

SURFACE MOUNT MULTILAYER
CERAMIC CAPACITORS

General purpose & High capacitance

Class 2, X5R

4 V TO 50 V

100 pF to 100 μ F

RoHS compliant & Halogen free



SCOPE

This specification describes X5R series chip capacitors with lead-free terminations.

APPLICATIONS

- PCs, Hard disk, Game PCs
- Power supplies
- DVD players
- Mobile phones
- Data processing

FEATURES

- Supplied in tape on reel
- Nickel-barrier end termination
- RoHS compliant
- Halogen free compliant

ORDERING INFORMATION-GLOBAL PART NUMBER, PHYCOMP

CTC & I2NC

All part numbers are identified by the series, size, tolerance, TC material, packing style, voltage, process code, termination and capacitance value.

YAGEO BRAND ordering code

GLOBAL PART NUMBER (PREFERRED)

CC xxxx x x **X5R** x **BB** xxx
 (1) (2) (3) (4) (5)

(1) SIZE – INCH BASED (METRIC)

- 0201 (0603)
- 0402 (1005)
- 0603 (1608)
- 0805 (2012)
- 1206 (3216)
- 1210 (3225)
- 1812 (4532)

(2) TOLERANCE

- K = ±10%
- M = ±20%

(3) PACKING STYLE

- R = Paper/PE taping reel; Reel 7 inch
- K = Blister taping reel; Reel 7 inch
- P = Paper/PE taping reel; Reel 13 inch
- F = Blister taping reel; Reel 13 inch
- C = Bulk case

(4) RATED VOLTAGE

- 4 = 4 V
- 5 = 6.3 V
- 6 = 10 V
- 7 = 16 V
- 8 = 25 V
- 9 = 50 V

(5) CAPACITANCE VALUE

2 significant digits+number of zeros
 The 3rd digit signifies the multiplying factor, and letter R is decimal point
 Example: 103 = 10 × 10³ = 10,000 pF = 10 nF

PHYCOMP BRAND ordering codes

GLOBAL PART NUMBER (preferred), PHYCOMP CTC (for North America) and I2NC (traditional) codes are acceptable to order Phycomp brand products.

GLOBAL PART NUMBER (PREFERRED)

For detailed information of GLOBAL PART NUMBER and ordering example, please refer to page 2.

I2NC CODE

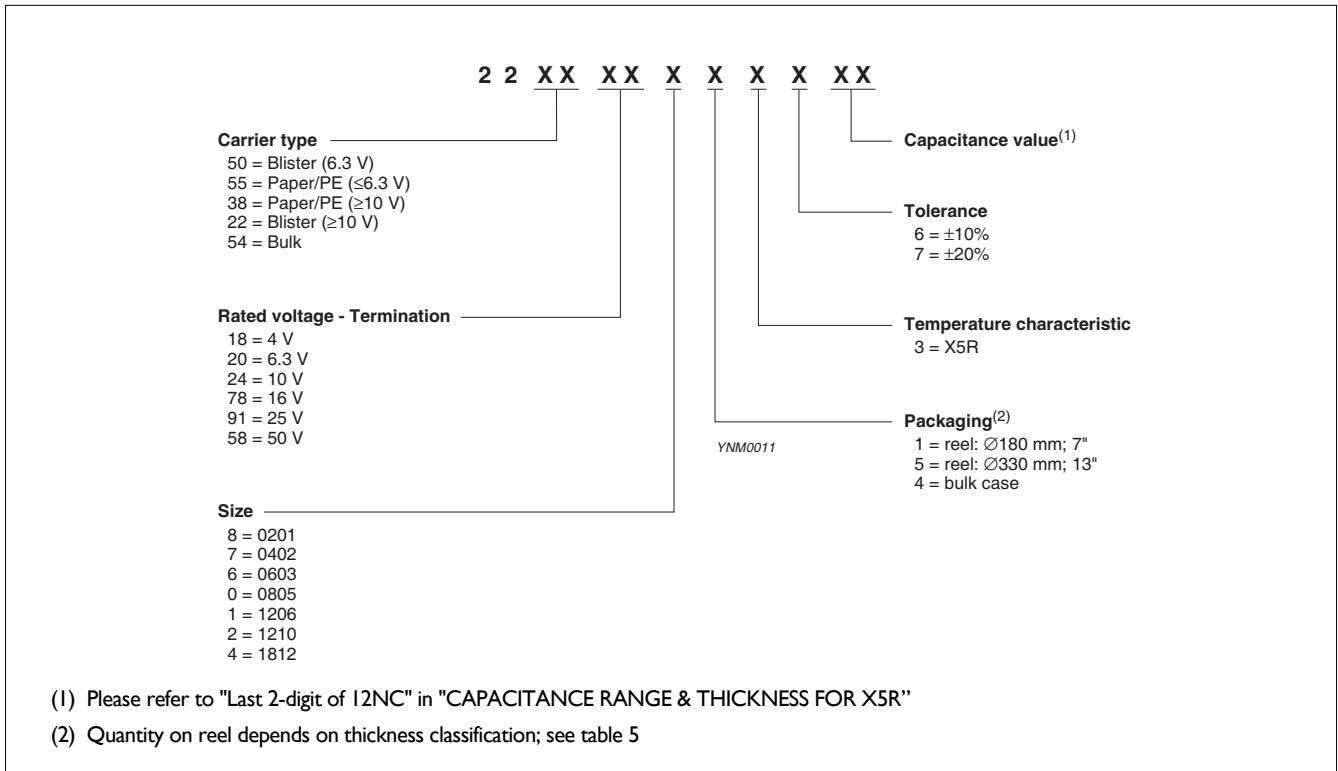

PHYCOMP CTC CODE (FOR NORTH AMERICA)

Example: 06032B225M5B20D

0603	2B	225	M	5	B	2	0	D
Size code	Temp. Char.	Capacitance in pF	Tolerance	Voltage	Termination	Packing	Marking	Range identifier
0201	2B = X5R	101 = 100 pF; the third digit signifies the multiplying factor:	K = $\pm 10\%$ M = $\pm 20\%$	4 = 4 V 5 = 6.3 V 6 = 10 V 7 = 16 V 8 = 25 V 9 = 50 V	B = NiSn	2 = 180 mm 7" Paper/PE 3 = 330 mm 13" Paper/PE	0 = no marking	D = Class 2 MLCC
0402								
0603								
0805								
1206		0 = $\times 1$				B = 180 mm 7" Blister		
1210		1 = $\times 10$				F = 330 mm 13" Blister		
1812		2 = $\times 100$ 3 = $\times 1,000$ 4 = $\times 10,000$ 5 = $\times 100,000$ 6 = $\times 1,000,000$ 7 = $\times 10,000,000$				P = Bulk case		

CONSTRUCTION

The capacitor consists of a rectangular block of ceramic dielectric in which a number of interleaved metal electrodes are contained. This structure gives rise to a high capacitance per unit volume.

The inner electrodes are connected to the two end terminations and finally covered with a layer of plated tin (NiSn). The terminations are lead-free. A cross section of the structure is shown in Fig.1.

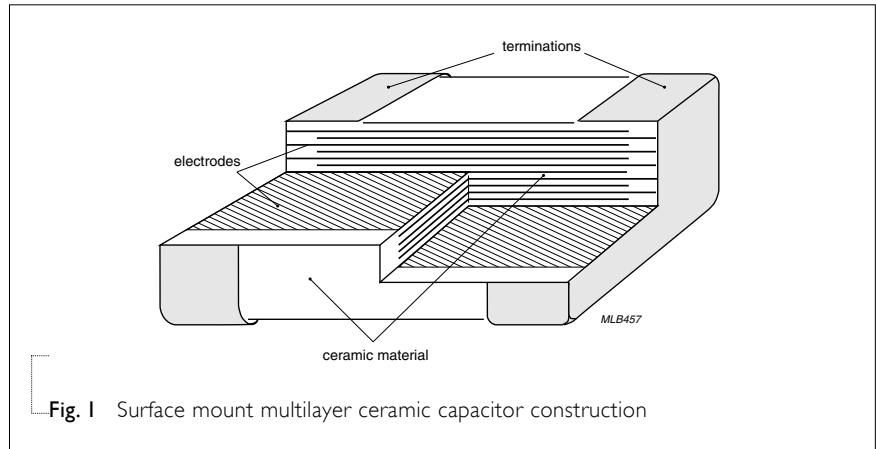

Fig. 1 Surface mount multilayer ceramic capacitor construction

DIMENSION

Table I For outlines see fig. 2

TYPE	L ₁ (mm)	W (mm)	T (MM)	L ₂ / L ₃ (mm)		L ₄ (mm)
				min.	max.	min.
0201	0.6 ±0.03 ⁽¹⁾	0.3 ±0.03 ⁽¹⁾	Refer to table 2 to 4	0.10	0.20	0.20
	0.6 ±0.05 ⁽²⁾	0.3 ±0.05 ⁽²⁾				
0402	1.0 ±0.05 ⁽¹⁾	0.5 ±0.05 ⁽¹⁾		0.20	0.30	0.40
	1.0 ±0.20 ⁽³⁾	0.5 ±0.20 ⁽³⁾				
0603	1.6 ±0.10 ⁽¹⁾	0.8 ±0.10 ⁽¹⁾		0.20	0.60	0.40
	1.6 ±0.15 ⁽²⁾	0.8 ±0.15 ⁽²⁾				
0805	2.0 ±0.10 ⁽¹⁾	1.25 ±0.10 ⁽¹⁾		0.25	0.75	0.55
	2.0 ±0.20 ⁽²⁾	1.25 ±0.20 ⁽²⁾				
1206	3.2 ±0.15 ⁽¹⁾	1.6 ±0.15 ⁽¹⁾		0.25	0.75	1.40
	3.2 ±0.30 ⁽²⁾	1.6 ±0.20 ⁽²⁾				
1210	3.2 ±0.20 ⁽¹⁾	2.5 ±0.20 ⁽¹⁾		0.25	0.75	1.40
	3.2 ±0.40 ⁽²⁾	2.5 ±0.30 ⁽²⁾				
1812	4.5 ±0.20 ⁽¹⁾	3.2 ±0.20 ⁽¹⁾	0.25	0.75	2.20	
	4.5 ±0.40 ⁽²⁾	3.2 ±0.40 ⁽²⁾				

NOTE

1. Dimensions for size 0201, C < 1 μF; 0402, C < 4.7 μF; 0603, C < 4.7 μF; 0805 to 1812, C ≤ 100nF
2. Dimensions for size 0201, C ≥ 1 μF; 0402, C ≥ 4.7 μF; 0603, 10 μF > C ≥ 4.7 μF; 0805 to 1812, C > 100 nF
3. Dimensions for size 0402, C ≥ 10 μF; 0603, C ≥ 10 μF; 1206, C ≥ 100 μF

OUTLINES

For dimension see Table I

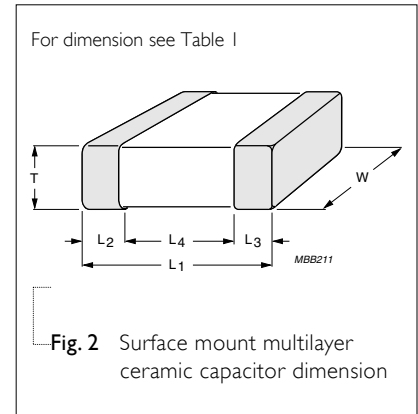

Fig. 2 Surface mount multilayer ceramic capacitor dimension

CAPACITANCE RANGE & THICKNESS FOR X5R

Table 2 Sizes from 0201 to 0402

CAP.	Last 2-digit of 12NC	0201 4 V					0402 4 V								
		6.3 V	10 V	16 V	25 V	50 V	6.3 V	10 V	16 V	25 V	50 V				
100 pF	09														
150 pF	12														
220 pF	14														
330 pF	16							0.3±0.03							
470 pF	18														
680 pF	21														
1.0 nF	23							0.3±0.03							
1.5 nF	25														
2.2 nF	27														
3.3 nF	29		0.3±0.03	0.3±0.03	0.3±0.03										
4.7 nF	32														
6.8 nF	34														
10 nF	36														
15 nF	39														
22 nF	41														
33 nF	43														
47 nF	45														
68 nF	47												0.5±0.05	0.5±0.05	0.5±0.05
100 nF	49														
150 nF	52														
220 nF	54		0.3±0.03	0.3±0.03	0.3±0.03					0.5±0.05	0.5±0.05				
330 nF	56														
470 nF	58		0.3±0.03	0.3±0.03									0.5±0.05	0.5±0.05	0.5±0.05
680 nF	61														
1.0 µF	63		0.3±0.05	0.3±0.05									0.5±0.05	0.5±0.05	
2.2 µF	67														
4.7 µF	72									0.5±0.15	0.5±0.15				
10 µF	76									0.5±0.20	0.5±0.20				

NOTE

1. Values in shaded cells indicate thickness class in mm
2. Capacitance value of non E-6 series is available on request

CAPACITANCE RANGE & THICKNESS FOR X5R

Table 3 Sizes from 0603 to 0805

CAP.	Last 2-digit of	0603				0805			
		12NC	6.3 V	10 V	16 V	25 V	6.3 V	10 V	16 V
10 nF	36								
15 nF	38								
22 nF	41								
33 nF	43								
47nF	45								
68 nF	47								
100 nF	49								
150 nF	52								
220 nF	54								
330 nF	56								
470 nF	58								
680 nF	61	0.8±0.1	0.8±0.1	0.8±0.1	0.8±0.1			0.85±0.1 1.25±0.2	1.25±0.2
1.0 µF	63					0.85±0.1 1.25±0.2	0.85±0.1 1.25±0.2		
2.2 µF	67							0.85±0.1 1.25±0.2	
4.7 µF	72			0.8±0.15					
10 µF	76		0.8±0.2					1.25±0.2	1.25±0.2
22 µF	81	0.8±0.2					1.25±0.2		
47 µF	85					1.25±0.2			
100 µF	89								

NOTE

1. Values in shaded cells indicate thickness class in mm
2. Capacitance value of non E-6 series is available on request

CAPACITANCE RANGE & THICKNESS FOR X5R

Table 4 Sizes from 1206 to 1812

CAP.	Last 2-digit of	1206				1210				1812	
		12NC	6.3 V	10 V	16 V	25 V	6.3 V	10 V	16 V	25 V	6.3 V
10 nF	36										
15 nF	38										
22 nF	41										
33 nF	43										
47nF	45										
68 nF	47										
100 nF	49										
150 nF	52										
220 nF	54										
330 nF	56										
470 nF	58										
680 nF	61										
1.0 μF	63										
2.2 μF	67	1.15±0.1	1.15±0.1	1.15±0.1	1.15±0.1						
4.7 μF	72										
10 μF	76	1.6±0.2	1.6±0.2	1.6±0.2	1.6±0.2	1.9±0.2	1.9±0.2	1.9±0.2	1.9±0.2		
22 μF	81						2.5±0.2	2.5±0.2	2.5±0.3		
47 μF	85					2.5±0.2					2.5±0.2
100 μF	89	1.6±0.3									3.2±0.3

NOTE

1. Values in shaded cells indicate thickness class in mm
2. Capacitance value of non E-6 series is available on request

THICKNESS CLASSES AND PACKING QUANTITY

Table 5

SIZE CODE	THICKNESS CLASSIFICATION	TAPE WIDTH QUANTITY PER REEL	Ø180 MM / 7 INCH		Ø330 MM / 13 INCH		QUANTITY PER BULK CASE
			Paper	Blister	Paper	Blister	
0201	0.3 ±0.03 mm	8 mm	15,000	---	50,000	---	---
0402	0.5 ±0.05 mm	8 mm	10,000	---	50,000	---	50,000
0603	0.8 ±0.1 mm	8 mm	4,000	---	15,000	---	15,000
0805	0.6 ±0.1 mm	8 mm	4,000	---	20,000	---	10,000
	0.85 ±0.1 mm	8 mm	4,000	---	15,000	---	8,000
	1.25 ±0.2 mm	8 mm	---	3,000	---	10,000	5,000
1206	0.6 ±0.1 mm	8 mm	4,000	---	20,000	---	---
	0.85 ±0.1 mm	8 mm	4,000	---	15,000	---	---
	1.00 / 1.15 ±0.1 mm	8 mm	---	3,000	---	10,000	---
	1.25 ±0.2 mm	8 mm	---	3,000	---	10,000	---
	1.6 ±0.15 mm	8 mm	---	2,500	---	10,000	---
1210	1.6 ±0.2 mm	8 mm	---	2,000	---	10,000	---
	0.6 / 0.7 ±0.1 mm	8 mm	---	4,000	---	15,000	---
	0.85 ±0.1 mm	8 mm	---	4,000	---	10,000	---
	1.15 ±0.1 mm	8 mm	---	3,000	---	10,000	---
	1.15 ±0.15 mm	8 mm	---	3,000	---	10,000	---
	1.25 ±0.2 mm	8 mm	---	3,000	---	---	---
	1.5 ±0.1 mm	8 mm	---	2,000	---	---	---
	1.6 / 1.9 ±0.2 mm	8 mm	---	2,000	---	---	---
1808	2.0 ±0.2 mm	8 mm	---	2,000 1,000	---	---	---
	2.5 ±0.2 mm	8 mm	---	1,000 500	---	---	---
	1.15 ±0.15 mm	12 mm	---	3,000	---	---	---
	1.25 ±0.2 mm	12 mm	---	3,000	---	---	---
	1.35 ±0.15 mm	12 mm	---	2,000	---	---	---
	1.5 ±0.1 mm	12 mm	---	2,000	---	---	---
	1.6 ±0.2 mm	12 mm	---	2,000	---	---	---
1812	2.0 ±0.2 mm	12 mm	---	2,000	---	---	---
	0.6 / 0.85 ±0.1 mm	12 mm	---	2,000	---	---	---
	1.15 ±0.1 mm	12 mm	---	1,000	---	---	---
	1.25 ±0.2 mm	12 mm	---	1,000	---	---	---
	1.5 ±0.1 mm	12 mm	---	1,000	---	---	---
	1.6 ±0.2 mm	12 mm	---	1,000	---	---	---
	2.0 ±0.2 mm	12 mm	---	1,000	---	---	---
2.5 ±0.2 mm	12 mm	---	500	---	---	---	

ELECTRICAL CHARACTERISTICS

X5R DIELECTRIC CAPACITORS; NISN TERMINATIONS

Unless otherwise specified, all tests and measurements shall be made under standard atmospheric conditions for testing as given in 5.3 of IEC 60068-1:

- Temperature: 15 °C to 35 °C
- Relative humidity: 25% to 75%
- Air pressure: 86 kPa to 106 kPa

Before the measurements are made, the capacitor shall be stored at the measuring temperature for a time sufficient to allow the entire capacitor to reach this temperature.

The period as prescribed for recovery at the end of a test is normally sufficient for this purpose.

Table 6

DESCRIPTION	VALUE
Capacitance range	10 nF to 100 µF
Capacitance tolerance	±10% and ±20%
Dissipation factor (D.F.)	
6.3 V	≤ 5%
Exception: 0402 ≥ 180 nF; 1210 ≥ 22 µF	≤ 7%
0201 ≥ 12 nF; 0402 ≥ 330 nF; 0603 ≥ 2.2 µF; 0805 ≥ 1 µF; 1206 ≥ 22 µF; 1210 ≥ 100 µF	≤ 10%
1206 ≥ 100 µF	≤ 15%
10 V	≤ 5%
Exception: 0402 ≥ 180 nF; 0805 ≥ 1 µF; 1206 ≥ 6.8 µF	≤ 7%
0201 ≥ 100 nF; 0402 ≥ 330 nF; 0603 ≥ 1 µF; 0805 ≥ 2.2 µF; 1206 ≥ 10 µF; 1210 ≥ 10 µF	≤ 10%
16 V	≤ 5%
Exception: 0402 ≥ 180 nF; 0603 ≥ 680 nF; 0805 ≥ 1 µF	≤ 7%
0402 ≥ 330 nF; 0603 ≥ 2.2 µF; 0805 ≥ 10 µF 1206 ≥ 10 µF; 1210 ≥ 10 µF	≤ 10%
≥ 25 V	≤ 3.5%
Exception: 0402 ≥ 27 nF; 0603 ≥ 220 nF; 0805 ≥ 2.2 µF; 1206 ≥ 4.7 µF; 1210 ≥ 10 µF	≤ 5%
0402 ≥ 180 nF	≤ 7%
0402 ≥ 470 nF; 1206 ≥ 10 µF 0805 ≥ 4.7 µF	≤ 10%
Insulation resistance after 1 minute at U_r (DC)	$R_{ins} \geq 10 \text{ G}\Omega$ or $R_{ins} \times C_r \geq 500$ seconds whichever is less
Maximum capacitance change as a function of temperature (temperature characteristic/coefficient):	±15%
Operating temperature range:	-55 °C to +85 °C

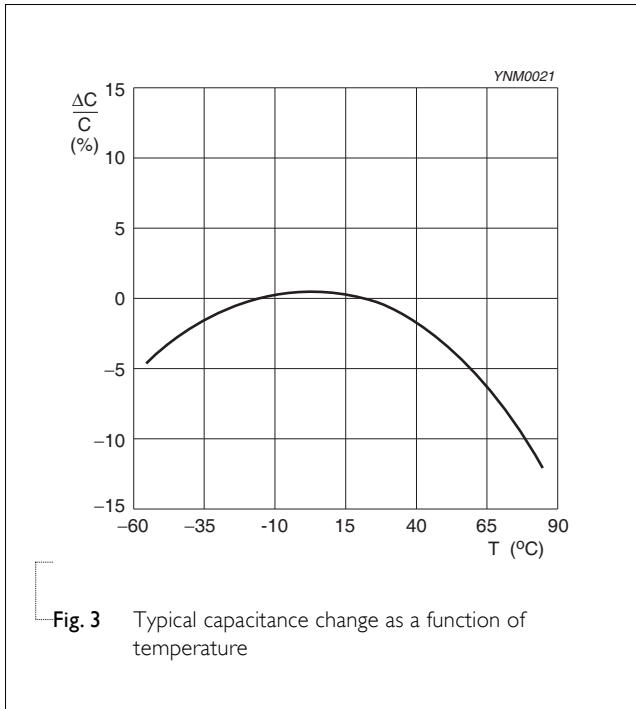

Size 0201 10 nF / 16 V
Solid lines: Impedance / Dotted lines: ESR

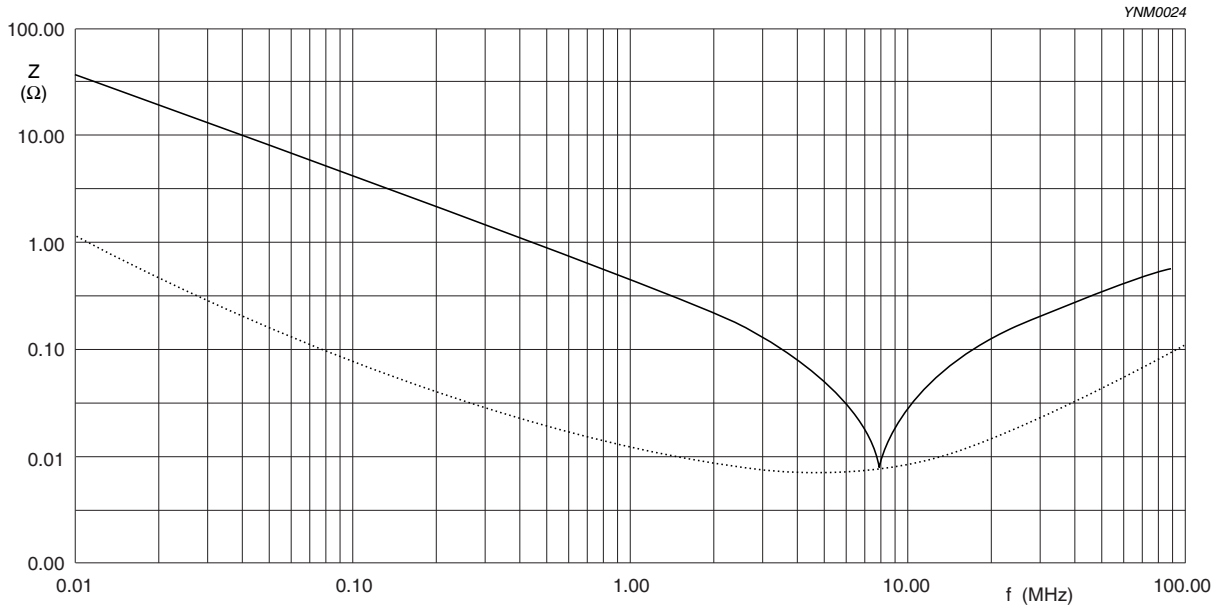

Fig. 4 Impedance ESR vs. frequency characteristics for multilayer chip capacitors

Size 0603 1 μF / 10 V
Solid lines: Impedance / Dotted lines: ESR

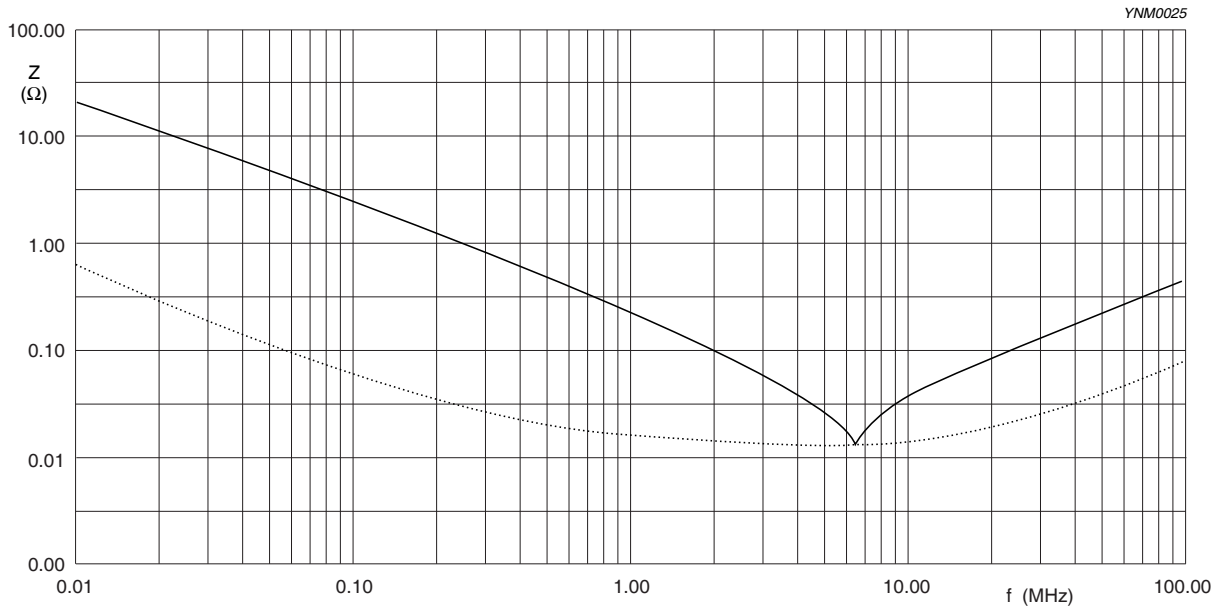

Fig. 5 Impedance ESR vs. frequency characteristics for multilayer chip capacitors

Size 0805 10 μ F / 6.3 V
Solid lines: Impedance / Dotted lines: ESR

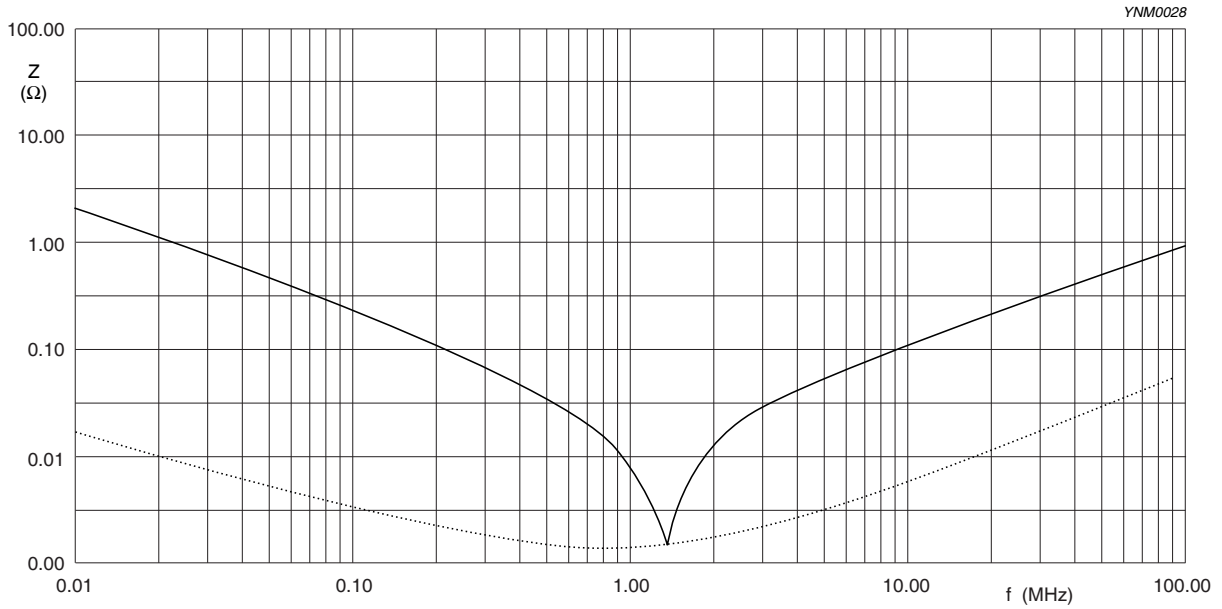

Fig. 6 Impedance ESR vs. frequency characteristics for multilayer chip capacitors

Size 1206 10 μ F / 16 V
Solid lines: Impedance / Dotted lines: ESR

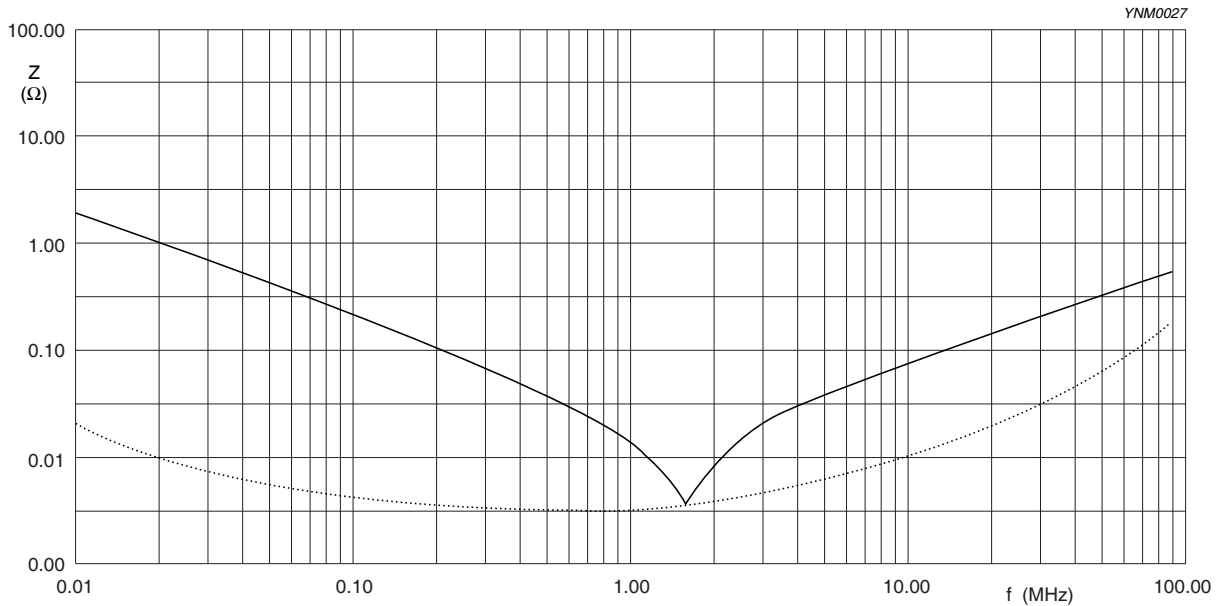

Fig. 7 Impedance ESR vs. frequency characteristics for multilayer chip capacitors

Size 1210 10 μ F / 25 V
Solid lines: Impedance / Dotted lines: ESR

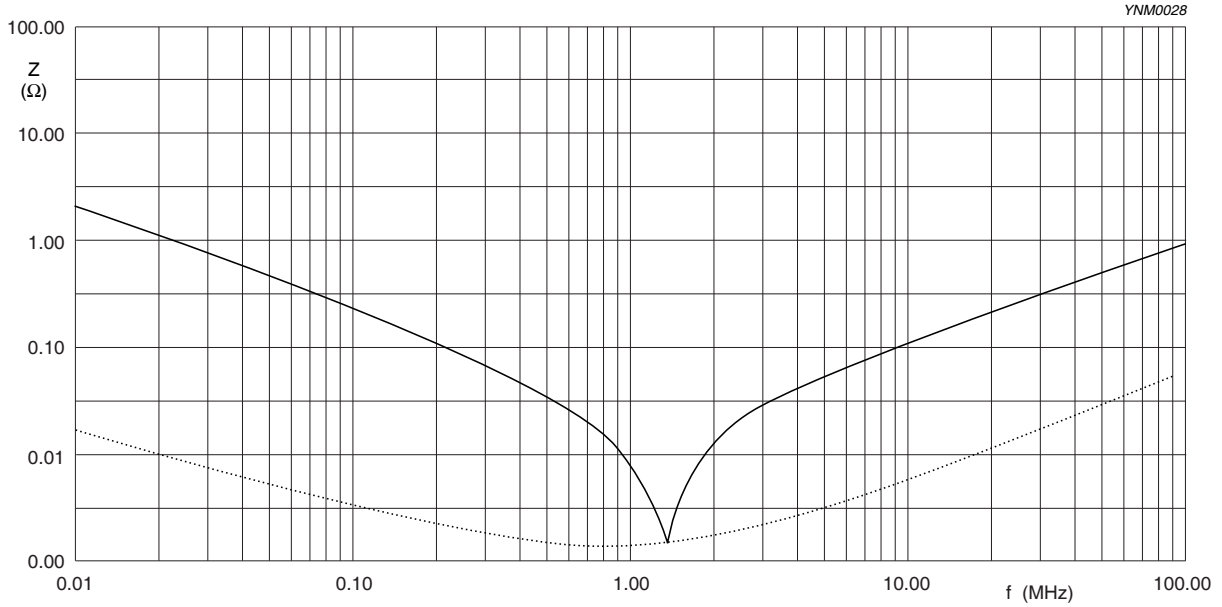

Fig. 8 Impedance ESR vs. frequency characteristics for multilayer chip capacitors

SOLDERING RECOMMENDATION

Table 7

SOLDERING METHOD	SIZE 0402	0603	0805	1206	≥ 1210
Reflow	≥ 0.1 μ F	≥ 1.0 μ F	≥ 2.2 μ F	≥ 4.7 μ F	Reflow only
Reflow/Wave	< 0.1 μ F	< 1.0 μ F	< 2.2 μ F	< 4.7 μ F	---

TESTS AND REQUIREMENTS
Table 8 Test procedures and requirements

TEST	TEST METHOD	PROCEDURE	REQUIREMENTS
Mounting	IEC 60384-21/22	4.3 The capacitors may be mounted on printed-circuit boards or ceramic substrates	No visible damage
Visual Inspection and Dimension Check		4.4 Any applicable method using $\times 10$ magnification	In accordance with specification
Capacitance ⁽¹⁾		4.5.1 Class 2: At 20 °C, 24 hrs after annealing f = 1 KHz for C \leq 10 μ F, rated voltage > 6.3 V, measuring at voltage 1 V _{rms} at 20 °C f = 1 KHz, for C \leq 10 μ F, rated voltage \leq 6.3 V, measuring at voltage 0.5 V _{rms} at 20 °C f = 120 Hz for C > 10 μ F, measuring at voltage 0.5 V _{rms} at 20 °C	Within specified tolerance
Dissipation Factor (D.F.) ⁽¹⁾		4.5.2 Class 2: At 20 °C, 24 hrs after annealing f = 1 KHz for C \leq 10 μ F, rated voltage > 6.3 V, measuring at voltage 1 V _{rms} at 20 °C f = 1 KHz, for C \leq 10 μ F, rated voltage \leq 6.3 V, measuring at voltage 0.5 V _{rms} at 20 °C f = 120 Hz for C > 10 μ F, measuring at voltage 0.5 V _{rms} at 20 °C	In accordance with specification
Insulation Resistance		4.5.3 At U _r (DC) for 1 minute	In accordance with specification
Temperature Characteristic		4.6 Class 2: Between minimum and maximum temperature X5R: -55 °C to +85 °C Normal Temperature: 20 °C	<General purpose series> Δ C/C Class 2: X5R: \pm 15% <High Capacitance series> Δ C/C Class 2: X5R: \pm 15%
Adhesion		4.7 A force applied for 10 seconds to the line joining the terminations and in a plane parallel to the substrate	Force size \geq 0603: 5N size = 0402: 2.5N size = 0201: 1N

NOTE

1. The figure indicates typical inspection. Please refer to individual specifications.

TEST	TEST METHOD	PROCEDURE	REQUIREMENTS
Bond Strength of Plating on End Face	IEC 60384-21/22	4.8 Mounting in accordance with IEC 60384-22 paragraph 4.3	No visible damage
		Conditions: bending 1 mm at a rate of 1 mm/s, radius jig 340 mm	<p><General purpose series></p> <p>$\Delta C/C$</p> <p>Class2:</p> <p>X5R: $\pm 10\%$</p> <p><High Capacitance series></p> <p>$\Delta C/C$</p> <p>Class2:</p> <p>X5R: $\pm 10\%$</p>
Resistance to Soldering Heat	4.9	Precondition: 150 ± 10 °C for 1 hour, then keep for 24 ± 1 hours at room temperature	Dissolution of the end face plating shall not exceed 25% of the length of the edge concerned
		Preheating: for size ≤ 1206 : 120 °C to 150 °C for 1 minute Preheating: for size >1206 : 100 °C to 120 °C for 1 minute and 170 °C to 200 °C for 1 minute Solder bath temperature: 260 ± 5 °C Dipping time: 10 ± 0.5 seconds Recovery time: 24 ± 2 hours	
			<p><General purpose series></p> <p>$\Delta C/C$</p> <p>Class2:</p> <p>X5R: $\pm 10\%$</p> <p><High Capacitance series></p> <p>$\Delta C/C$</p> <p>Class2:</p> <p>X5R: $\pm 10\%$</p>
			<p>D.F. within initial specified value</p> <p>R_{ins} within initial specified value</p>
Solderability	4.10	Preheated the temperature of 80 °C to 140 °C and maintained for 30 seconds to 60 seconds.	The solder should cover over 95% of the critical area of each termination
		Test conditions for lead-free containing solder alloy Temperature: 235 ± 5 °C Dipping time: 2 ± 0.2 seconds Depth of immersion: 10 mm Alloy Composition: 60/40 Sn/Pb Number of immersions: 1	
		Test conditions for lead-free containing solder alloy Temperature: 245 ± 5 °C Dipping time: 3 ± 0.3 seconds Depth of immersion: 10 mm Alloy Composition: SAC305 Number of immersions: 1	

TEST	TEST METHOD	PROCEDURE	REQUIREMENTS
Rapid Change of Temperature	IEC 60384-21/22	4.11 Preconditioning: 150 +0/-10 °C for 1 hour, then keep for 24 ± 1 hours at room temperature 5 cycles with following detail: 30 minutes at lower category temperature 30 minutes at upper category temperature Recovery time 24 ± 2 hours	No visual damage <General purpose series> ΔC/C Class2: X5R: ± 15% <High Capacitance series> ΔC/C Class2: X5R: ± 15% D.F. meet initial specified value R _{ins} meet initial specified value
Damp Heat with U _r Load	4.13	1. Preconditioning, class 2 only: 150 +0/-10 °C / 1 hour, then keep for 24 ± 1 hour at room temp 2. Initial measure: Spec: refer to initial spec C, D, IR 3. Damp heat test: 500 ± 12 hours at 40 ± 2 °C; 90 to 95% R.H. 1.0 U _r applied 4. Recovery: Class 2: 24 ± 2 hours 5. Final measure: C, D, IR P.S. If the capacitance value is less than the minimum value permitted, then after the other measurements have been made the capacitor shall be preconditioned according to "IEC 60384 4.1" and then the requirements shall be met.	No visual damage after recovery <General purpose series> ΔC/C Class2: X5R: ± 15% D.F. Class2: X5R: ≤ 16V: ≤ 7% ≥ 25V: ≤ 5% R _{ins} Class2: X5R: ≥ 500 MΩ or R _{ins} × C _r ≥ 25s whichever is less <High Capacitance series> ΔC/C Class2: X5R: ± 20% D.F. Class2: X5R: 2 × initial value max R _{ins} Class2: X5R: 500 MΩ or R _{ins} × C _r ≥ 25s whichever is less

TEST	TEST METHOD	PROCEDURE	REQUIREMENTS
Endurance	IEC 60384-21/22 4.14	1. Preconditioning, class 2 only: 150 +0/-10 °C /1 hour, then keep for 24 ±1 hour at room temp 2. Initial measure: Spec: refer to initial spec C, D, IR 3. Endurance test: Temperature: X5R: 85 °C Specified stress voltage applied for 1,000 hours: Applied 2.0 × U _r for general product. Applied 1.5 × U _r for high cap. product. 4. Recovery time: 24 ±2 hours 5. Final measure: C, D, IR P.S. If the capacitance value is less than the minimum value permitted, then after the other measurements have been made the capacitor shall be preconditioned according to "IEC 60384 4.1" and then the requirements shall be met.	No visual damage <General purpose series> ΔC/C Class2: X5R: ±15% D.F. Class2: X5R: ≤ 16V: ≤ 7% ≥ 25V: ≤ 5% R _{ins} Class2: X5R: ≥ 1,000 MΩ or R _{ins} × C _r ≥ 50s whichever is less <High Capacitance series> ΔC/C Class 2: X5R: ±20% D.F. Class 2: X5R: 2 × initial value max R _{ins} Class 2: X5R: 1,000 MΩ or R _{ins} × C _r ≥ 50s whichever is less
		Specified stress voltage applied for 1 minute U _r ≤ 100 V: series applied 2.5 U _r 100 V < U _r ≤ 200 V series applied (1.5 U _r + 100) 200 V < U _r ≤ 500 V series applied (1.3 U _r + 100) U _r > 500 V: 1.3 U _r I: 7.5 mA	No breakdown or flashover

REVISION HISTORY

REVISION	DATE	CHANGE NOTIFICATION	DESCRIPTION
Version 14	May 16, 2012	-	- Product range updated
Version 13	May 02, 2012	-	- Product range updated
Version 12	Feb 10, 2012	-	- Product range updated
Version 11	Oct 21, 2011	-	- Product range updated
Version 10	Jun 21, 2011	-	- Product range updated
Version 9	Mar 23, 2011	-	- Product range updated
Version 8	Jan 25, 2011	-	- Rated voltage of 0201 extend to 50V
Version 7	Jan 05, 2011	-	- Product range updated
Version 6	Jul 27, 2010	-	- Dimension on 0603 and 1206 case size updated
Version 5	Apr 21, 2010	-	- The statement of "Halogen free" on the cover added - Dimension updated
Version 4	Jan 13, 2010	-	- Thickness updated
Version 3	Aug 17, 2009	-	- Dimension updated
Version 2	Jun 09, 2009	-	- Ordering code updated
Version 1	May 15, 2009	-	- Product range updated
Version 0	Apr 15, 2009	-	- New datasheet for general purpose and high capacitance X5R series with RoHS compliant - Replace the "6.3V to 50V" part of pdf files: UP-X5R_X7R_HighCaps_6.3-to-25V_11, UY-X5R_X7R_HighCaps_6.3-to-25V_11 - Combine 0201 from pdf files: UP-NP0X5RX7RY5V_0201_6.3-to-50V_2 and UY-NP0X5RX7RY5V_0201_6.3-to-50V_2 - Define global part number - Description of "Halogen free compliant" added - Test method and procedure updated

Mouser Electronics

Authorized Distributor

Click to View Pricing, Inventory, Delivery & Lifecycle Information:

Yageo:

[CC0402KRX5R7BB104](#) [CC0402KRX5R6BB224](#) [CC0402KRX5R6BB104](#) [CC0402KRX5R5BB224](#)
[CC0603KRX5R8BB474](#) [CC0603KRX5R8BB334](#) [CC0603KRX5R7BB474](#) [CC0603KRX5R6BB474](#)
[CC0603KRX5R6BB334](#) [CC0805KKX5R6BB106](#) [CC0402KRX5R5BB105](#) [CC1210KKX5R6BB226](#)
[CC0805KKX5R6BB475](#) [CC0805KKX5R6BB225](#) [CC0603KRX5R6BB105](#) [CC1210MKX5R6BB226](#)
[CC0603KRX5R5BB225](#) [CC0603KRX5R7BB105](#) [CC0805MKX5R5BB226](#) [CC0603KRX5R5BB106](#)
[CC0201KRX5R5BB104](#) [CC0201KRX5R6BB103](#) [CC0201MRX5R5BB104](#) [CC0603KRX5R6BB224](#)
[CC1210KKX5R7BB106](#) [CC0805KRX5R5BB106](#) [CC0603KRX5R5BB475](#) [CC0603MRX5R5BB106](#)
[CC0805KRX5R6BB475](#) [CC0402KPX5R6BB104](#) [CC0402KRX5R7BB224](#) [CC0402MRX5R5BB225](#)
[CC0805KFX5R5BB106](#) [CC0805KKX5R6BB105](#) [CC0805KKX5R7BB106](#) [CC0805KKX5R8BB475](#)
[CC0805KRX5R6BB225](#) [CC1210KKX5R8BB106](#) [CC1210MKX5R9BB106](#) [CC1210MKX5R5BB107](#)
[CC0201KRX5R5BB333](#) [CC0201KRX5R5BB473](#) [CC0201MRX5R5BB224](#) [CC0805KKX5R7BB475](#)
[CC0201KPX5R5BB104](#) [CC0201KRX5R7BB103](#) [CC0201MRX5R5BB105](#) [CC0402KPX5R5BB105](#)
[CC0402KPX5R5BB474](#) [CC0402KRX5R5BB154](#) [CC0402KRX5R5BB225](#) [CC0402KRX5R5BB334](#)
[CC0402KRX5R6BB154](#) [CC0402KRX5R6BB474](#) [CC0402KRX5R6BB823](#) [CC0402KRX5R7BB105](#)
[CC0402KRX5R7BB683](#) [CC0402KRX5R9BB681](#) [CC0402MRX5R5BB104](#) [CC0402MRX5R5BB224](#)
[CC0402MRX5R6BB104](#) [CC0402MRX5R6BB105](#) [CC0402MRX5R6BB224](#) [CC0402MRX5R7BB104](#)
[CC0603KPX5R6BB105](#) [CC0603KPX5R6BB225](#) [CC0603KPX5R7BB105](#) [CC0603KPX5R8BB105](#)
[CC0603KRX5R5BB224](#) [CC0603KRX5R5BB684](#) [CC0603KRX5R6BB684](#) [CC0603KRX5R7BB224](#)
[CC0603KRX5R7BB334](#) [CC0603KRX5R7BB475](#) [CC0603KRX5R8BB224](#) [CC0603MRX5R5BB105](#)
[CC0603MRX5R5BB225](#) [CC0603MRX5R6BB105](#) [CC0603MRX5R6BB106](#) [CC0603MRX5R6BB225](#)
[CC0603MRX5R6BB335](#) [CC0603MRX5R6BB474](#) [CC0603MRX5R6BB475](#) [CC0603MRX5R7BB105](#)
[CC0603MRX5R8BB224](#) [CC0201KRX5R5BB103](#) [CC0805KKX5R8BB225](#) [CC0402KRX5R5BB104](#)
[CC0603KRX5R6BB225](#) [CC0603KRX5R6BB475](#) [CC0603KRX5R8BB105](#) [CC0805KKX5R5BB106](#)
[CC0402KRX5R6BB105](#) [CC0402KRX5R6BB683](#) [CC0402KRX5R5BB474](#) [CC0603KRX5R5BB474](#)
[CC0402KRX5R6BB473](#) [CC0805KKX5R7BB105](#) [CC0805KRX5R7BB225](#) [CC0805KKX5R5BB475](#)



Компания «ЭлектроПласт» предлагает заключение долгосрочных отношений при поставках импортных электронных компонентов на взаимовыгодных условиях!

Наши преимущества:

- Оперативные поставки широкого спектра электронных компонентов отечественного и импортного производства напрямую от производителей и с крупнейших мировых складов;
- Поставка более 17-ти миллионов наименований электронных компонентов;
- Поставка сложных, дефицитных, либо снятых с производства позиций;
- Оперативные сроки поставки под заказ (от 5 рабочих дней);
- Экспресс доставка в любую точку России;
- Техническая поддержка проекта, помощь в подборе аналогов, поставка прототипов;
- Система менеджмента качества сертифицирована по Международному стандарту ISO 9001;
- Лицензия ФСБ на осуществление работ с использованием сведений, составляющих государственную тайну;
- Поставка специализированных компонентов (Xilinx, Altera, Analog Devices, Intersil, Interpoint, Microsemi, Aeroflex, Peregrine, Syfer, Eurofarad, Texas Instrument, Miteq, Cobham, E2V, MA-COM, Hittite, Mini-Circuits, General Dynamics и др.);

Помимо этого, одним из направлений компании «ЭлектроПласт» является направление «Источники питания». Мы предлагаем Вам помощь Конструкторского отдела:

- Подбор оптимального решения, техническое обоснование при выборе компонента;
- Подбор аналогов;
- Консультации по применению компонента;
- Поставка образцов и прототипов;
- Техническая поддержка проекта;
- Защита от снятия компонента с производства.



Как с нами связаться

Телефон: 8 (812) 309 58 32 (многоканальный)

Факс: 8 (812) 320-02-42

Электронная почта: org@eplast1.ru

Адрес: 198099, г. Санкт-Петербург, ул. Калинина, дом 2, корпус 4, литера А.