

## 350mW, SMD Switching Diode

### FEATURES

- Designed for mounting on small surface
- Low Capacitance
- Low forward voltage drop
- Compliant to RoHS directive 2011/65/EU and in accordance to WEEE 2002/96/EC
- Halogen-free according to IEC 61249-2-21

### APPLICATIONS

- Switching mode power supply (SMPS)
- Adapters
- Lighting application
- On-board DC/DC converter

### MECHANICAL DATA

- Case: SOT-23
- Molding compound meets UL 94 V-0 flammability rating
- Moisture sensitivity level: level 1, per J-STD-020
- Packing code with suffix "G" means green compound (halogen-free)
- Terminal: Matte tin plated leads, solderable per J-STD-002
- Meet JESD 201 class 1A whisker test
- Polarity: Indicated by cathode band
- Weight: 8 mg (approximately)

| KEY PARAMETERS      |             |      |
|---------------------|-------------|------|
| PARAMETER           | VALUE       | UNIT |
| $I_{F(AV)}$         | 200         | mA   |
| $V_{RRM}$           | 100         | V    |
| $I_{FSM}$           | 2           | A    |
| $V_F$ at $I_F=10mA$ | 1           | V    |
| $T_J$ Max.          | 150         | °C   |
| Package             | SOT-23      |      |
| Configuration       | Single dice |      |



| ABSOLUTE MAXIMUM RATINGS ( $T_A=25^{\circ}C$ unless otherwise noted) |               |             |             |      |
|--|---------------|-------------|-------------|------|
| PARAMETER  |               | SYMBOL      | PART NUMBER | UNIT |
| Marking code on the device   | MMBD4148      |             | 5D          |      |
|  | MMBD4148CA    |             | A1          |      |
|  | MMBD4148CC    |             | A4          |      |
|  | MMBD4148SE    |             | A7          |      |
| Repetitive peak reverse voltage                                      |               | $V_{RRM}$   | 75          | V    |
| Forward current  |               | $I_{F(AV)}$ | 200         | mA   |
| Repetitive peak forward surge current                                |               | $I_{FRM}$   | 700         | mA   |
| Non-repetitive peak forward surge current                            | at $t=1\mu s$ | $I_{FSM}$   | 2           | A    |
|  | at $t=1s$     |             | 1           |      |
| Junction temperature range   |               | $T_J$       | -55 to +150 | °C   |
| Storage temperature range  |               | $T_{STG}$   | -55 to +150 | °C   |

| <b>THERMAL PERFORMANCE</b>             |                 |              |                      |
|--|-----------------|--------------|----------------------|
| <b>PARAMETER</b>                       | <b>SYMBOL</b>   | <b>LIMIT</b> | <b>UNIT</b>          |
| Junction-to-ambient thermal resistance | $R_{\theta JA}$ | 357          | $^{\circ}\text{C/W}$ |

| <b>ELECTRICAL SPECIFICATIONS</b> ( $T_A = 25^{\circ}\text{C}$ unless otherwise noted) |   |               |            |            |               |
|---|---|---------------|------------|------------|---------------|
| <b>PARAMETER</b>  | <b>CONDITIONS</b>   | <b>SYMBOL</b> | <b>MIN</b> | <b>MAX</b> | <b>UNIT</b>   |
| Forward voltage per diode <sup>(1)</sup>  | $I_F = 10\text{mA}, T_J = 25^{\circ}\text{C}$                           | $V_F$         | -          | 1.0        | V             |
| Reverse current @ rated $V_R$ per diode <sup>(2)</sup>                                | $V_R = 20\text{V}, T_J = 25^{\circ}\text{C}$                            | $I_R$         | -          | 25.0       | nA            |
|   | $V_R = 75\text{V}, T_J = 25^{\circ}\text{C}$                            |               | -          | 5.0        | $\mu\text{A}$ |
|   | $V_R = 20\text{V}, T_A = 150^{\circ}\text{C}$                           |               | -          | 50.0       |               |
| Reverse breakdown voltage   | $I_R = 5\mu\text{A}, T_J = 25^{\circ}\text{C}$                          | $V_{(BR)}$    | 75         | -          | V             |
|   | $I_R = 100\mu\text{A}, T_J = 25^{\circ}\text{C}$                        |               | 100        | -          |               |
| Junction capacitance  | 1 MHz, $V_R = 0\text{V}$  | $C_J$         | -          | 4.0        | pF            |
| Reverse recovery time   | $I_F = 10\text{mA}, I_R = 1\text{mA}, R_L = 100\Omega, V_R = 6\text{V}$ | $t_{rr}$      | -          | 4.0        | ns            |

**Notes:**

1. Pulse test with  $PW = 0.3\text{ ms}$
2. Pulse test with  $PW = 30\text{ ms}$

| <b>ORDERING INFORMATION</b> |                     |                            |                |                |
|-----------------------------|---------------------|----------------------------|----------------|----------------|
| <b>PART NO.</b>             | <b>PACKING CODE</b> | <b>PACKING CODE SUFFIX</b> | <b>PACKAGE</b> | <b>PACKING</b> |
| MMBD414X<br>(Note 1&2)      | RF                  | G                          | SOT-23         | 3K / 7" Reel   |
|                             | R5                  |                            |                | 10K / 13" Reel |

**Notes:**

1. Whole series with green compound
2. "XX" is Device code from "8" to "8SE".

| <b>EXAMPLE</b>     |                 |                     |                            |                    |
|--------------------|-----------------|---------------------|----------------------------|--------------------|
| <b>EXAMPLE P/N</b> | <b>PART NO.</b> | <b>PACKING CODE</b> | <b>PACKING CODE SUFFIX</b> | <b>DESCRIPTION</b> |
| MMBD4148 RFG       | MMBD4148        | RF                  | G                          | Green compound     |

**CHARACTERISTICS CURVES**

( $T_A = 25^\circ\text{C}$  unless otherwise noted)

**Fig. 1 Power Derating Curve**

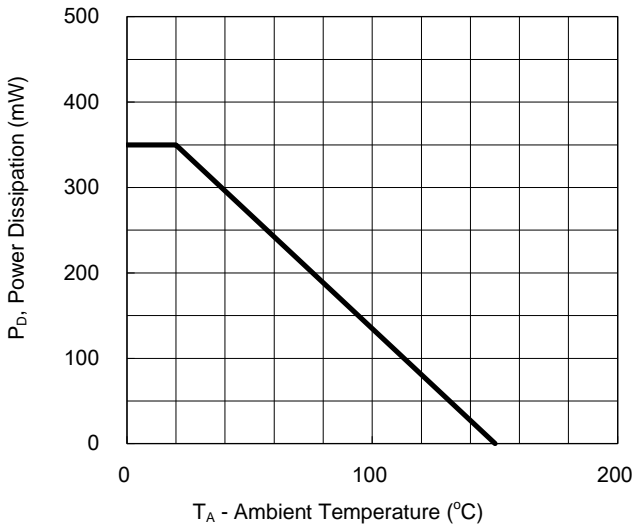

**Fig.2 Forward Characteristics**

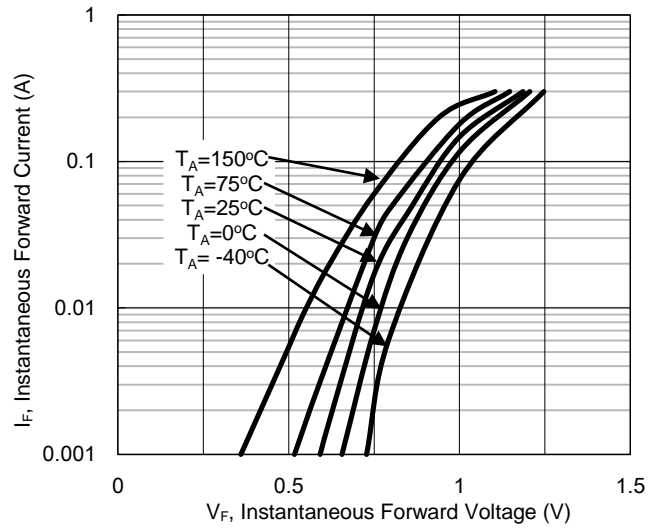

**Fig.3 Typical Reverse Characteristics**

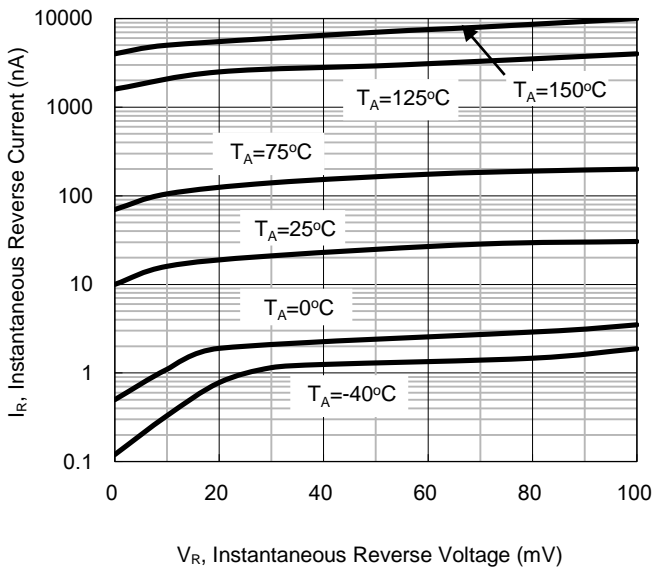

**Fig.4 Typical Capacitance vs. Reverse Voltage**

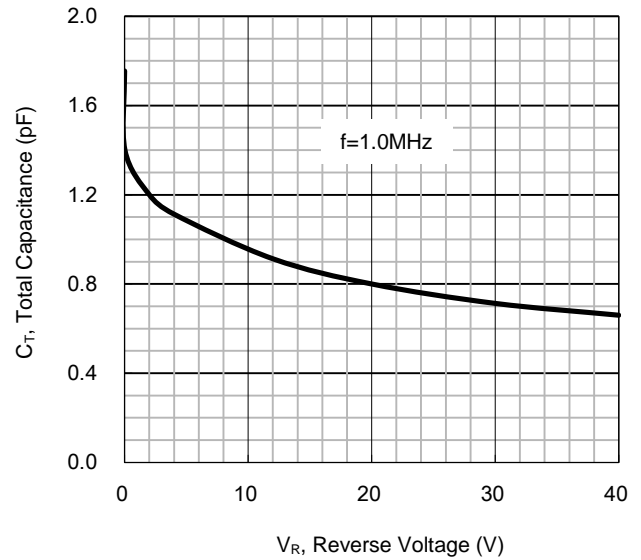

**PACKAGE OUTLINE DIMENSION**

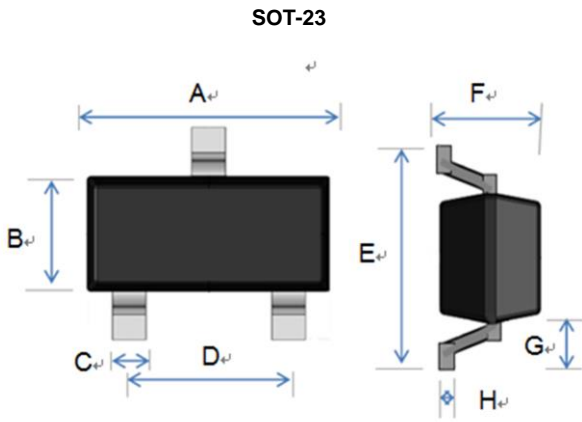

| DIM. | Unit(mm) |      | Unit(inch) |       |
|------|----------|------|------------|-------|
|      | Min      | Max  | Min        | Max   |
| A    | 2.70     | 3.10 | 0.106      | 0.122 |
| B    | 1.10     | 1.50 | 0.043      | 0.059 |
| C    | 0.30     | 0.51 | 0.012      | 0.020 |
| D    | 1.78     | 2.04 | 0.070      | 0.080 |
| E    | 2.10     | 2.64 | 0.083      | 0.104 |
| F    | 0.89     | 1.30 | 0.035      | 0.051 |
| G    | 0.55 REF |      | 0.022 REF  |       |
| H    | 0.10 REF |      | 0.004 REF  |       |

**SUGGEST PAD LAYOUT**

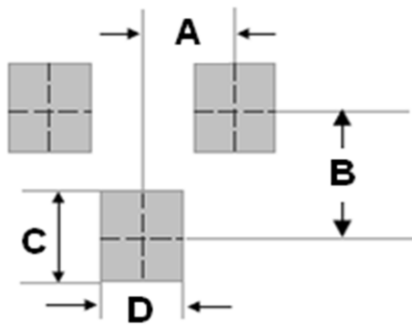

| DIM. | Unit(mm) | Unit(inch) |
|------|----------|------------|
|      | TYP      | TYP        |
| A    | 0.95     | 0.037      |
| B    | 2.00     | 0.079      |
| C    | 0.90     | 0.035      |
| D    | 0.80     | 0.031      |

**PIN CONFIGURATION**

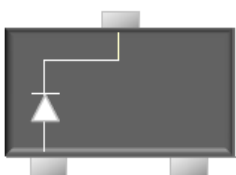

**MMBD4148**

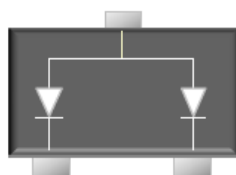

**MMBD4148CA**

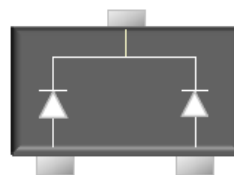

**MMBD4148CC**

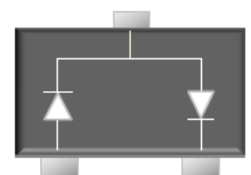

**MMBD4148SE**

## Notice

Specifications of the products displayed herein are subject to change without notice. TSC or anyone on its behalf, assumes no responsibility or liability for any errors or inaccuracies.

Information contained herein is intended to provide a product description only. No license, express or implied, to any intellectual property rights is granted by this document. Except as provided in TSC's terms and conditions of sale for such products, TSC assumes no liability whatsoever, and disclaims any express or implied warranty, relating to sale and/or use of TSC products including liability or warranties relating to fitness for a particular purpose, merchantability, or infringement of any patent, copyright, or other intellectual property right.

The products shown herein are not designed for use in medical, life-saving, or life-sustaining applications. Customers using or selling these products for use in such applications do so at their own risk and agree to fully indemnify TSC for any damages resulting from such improper use or sale.



Компания «ЭлектроПласт» предлагает заключение долгосрочных отношений при поставках импортных электронных компонентов на взаимовыгодных условиях!

Наши преимущества:

- Оперативные поставки широкого спектра электронных компонентов отечественного и импортного производства напрямую от производителей и с крупнейших мировых складов;
- Поставка более 17-ти миллионов наименований электронных компонентов;
- Поставка сложных, дефицитных, либо снятых с производства позиций;
- Оперативные сроки поставки под заказ (от 5 рабочих дней);
- Экспресс доставка в любую точку России;
- Техническая поддержка проекта, помощь в подборе аналогов, поставка прототипов;
- Система менеджмента качества сертифицирована по Международному стандарту ISO 9001;
- Лицензия ФСБ на осуществление работ с использованием сведений, составляющих государственную тайну;
- Поставка специализированных компонентов (Xilinx, Altera, Analog Devices, Intersil, Interpoint, Microsemi, Aeroflex, Peregrine, Syfer, Eurofarad, Texas Instrument, Miteq, Cobham, E2V, MA-COM, Hittite, Mini-Circuits, General Dynamics и др.);

Помимо этого, одним из направлений компании «ЭлектроПласт» является направление «Источники питания». Мы предлагаем Вам помощь Конструкторского отдела:

- Подбор оптимального решения, техническое обоснование при выборе компонента;
- Подбор аналогов;
- Консультации по применению компонента;
- Поставка образцов и прототипов;
- Техническая поддержка проекта;
- Защита от снятия компонента с производства.



#### Как с нами связаться

**Телефон:** 8 (812) 309 58 32 (многоканальный)

**Факс:** 8 (812) 320-02-42

**Электронная почта:** [org@eplast1.ru](mailto:org@eplast1.ru)

**Адрес:** 198099, г. Санкт-Петербург, ул. Калинина, дом 2, корпус 4, литера А.