

Excellent EMI Immunity Low Noise, Precision Operational Amplifiers

FEATURES ($V^+ = 5V, V = 0V, T_a = 25^\circ C$)

- Precision $V_{IO} = 50\mu V$ max.
 $V_{IO} = 100\mu V$ max. ($-40^\circ C$ to $+125^\circ C$)
- Low Offset Drift $0.6\mu V/^\circ C$ max.
- Integrated EMI filter EMIRR = 78dB typ. @ $f = 900MHz$
- Low Bias Current $2.5nA$ max.
- Low Noise $8nV/\sqrt{Hz}$ typ. @ $f = 1kHz$
- Unity Gain Stable
- No Phase Reversal
- Operating Voltage $\pm 2.25V$ to $\pm 18V$
- Operating Temperature $-40^\circ C$ to $+125^\circ C$
- Package SOP8 JEDEC150mil,
MSOP8 (VSP8)*
DFN8-W2 (ESON8-W2)
(3mm x 3mm)
*meet JEDEC MO-187-DA

APPLICATION

- Temperature Sensor
- Current Sensor
- Bridge Amplifier
- Battery Monitor
- Photodiode Amplification
- Automatic Test Equipment

GENERAL DESCRIPTION

The NJMOP277 (Single) / NJMOP2277 (Dual) are high precision operational amplifiers featuring low offset voltage drift of top-class, low offset voltage and low noise and high voltage gain. The NJMOP277 / NJMOP2277 excellent electrical characteristics are guaranteed over a wide operating range ($-40^\circ C$ to $+125^\circ C, \pm 5V$ to $\pm 15V$). Therefore, it is most suitable for measuring instruments that require stability against ambient temperature change and/or for applications such as configuring high gain circuits to process very small signals. Moreover, they have the advantage very small package and high RF noise immunity. It is easy to replacement from defact standard precision operational amplifier: OP-177 series and to design against RF immunity, too.

RELATED PRODUCTS

FEATURES	Single	Dual	Quad
JFET Input Precision OP-AMP ($V_{IO} = 400\mu V, SR = 20V/\mu s$)	—	NJM8512	NJM8513
CMOS Precision OP-AMP ($V_{IO} = 150\mu V$)	NJU7076	NJU7077	NJU7078

INPUT OFFSET VOLTAGE GRADE

*Under Development

Grade	PART NUMBER	Offset Voltage (μV max.) $T_a = 25^\circ C$	Offset Drift ($\mu V/^\circ C$ max.) $T_a = -40$ to $125^\circ C$	Offset Current (nA max.) $T_a = -40$ to $125^\circ C$
F-Grade	NJMOP277FE* NJMOP277FR* NJMOP2277FE*	20	0.15	2
G-Grade	NJMOP277GE* NJMOP277GR* NJMOP2277GE* NJMOP2277GR	50	0.6	3
-	NJMOP2277KW2*	100	0.7	3

TYPICAL CHARACTERISTICS

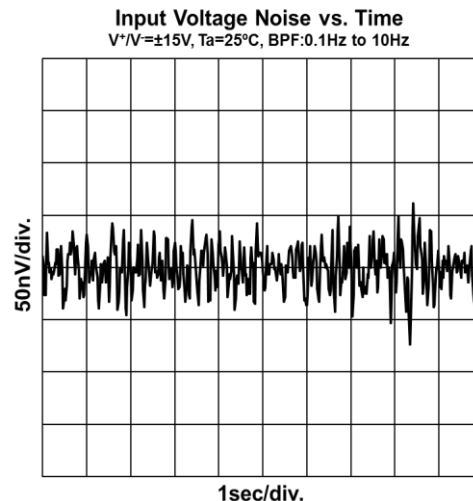
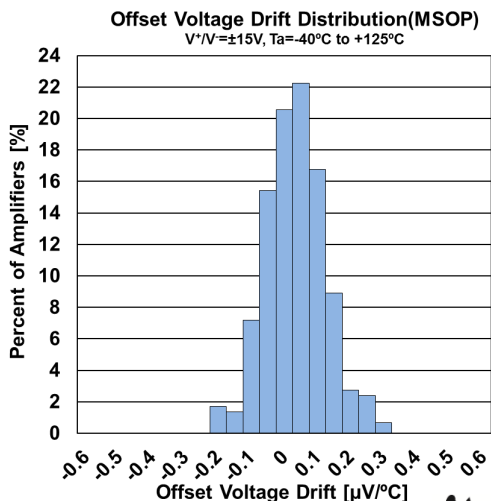

■PIN CONFIGURATION

*Under Development

PART NUMBER	NJMOP277GE* / NJMOP277FE*	NJMOP277GR* / NJMOP277FR*
Package Outline	SOP8 JEDEC150mil	MSOP8 (VSP8)

Pin Function

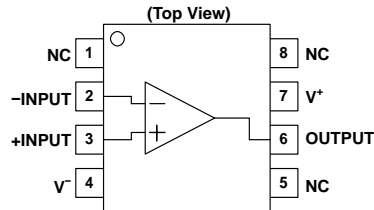

PART NUMBER	NJMOP2277GE* / NJMOP2277FE*	NJMOP2277GR
Package Outline	SOP8 JEDEC150mil	MSOP8 (VSP8)

Pin Function

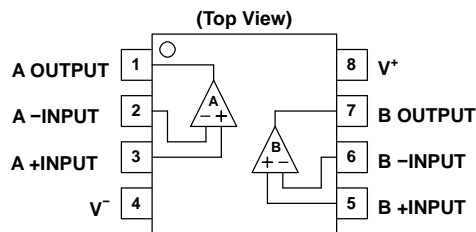

PART NUMBER	NJMOP2277KW2*
Package Outline	DFN8-W2 (ESON8-W2)

Pin Function

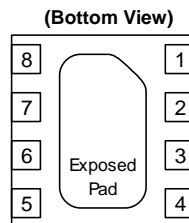
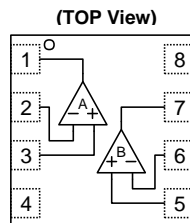

1. A OUTPUT
2. A -INPUT
3. A +INPUT
4. V⁻
5. B +INPUT
6. B -INPUT
7. B OUTPUT
8. V⁺

*Connect to exposed pad to V

■PRODUCT NAME INFORMATION

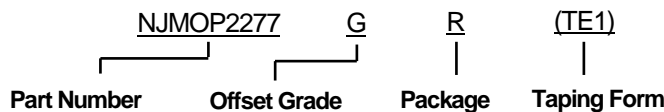

■ORDERING INFORMATION

*Under Development

PART NUMBER	PACKAGE OUTLINE	RoHS	Halogen-Free	TERMINAL FINISH	MARKING	WEIGHT (mg)	MOQ (pcs)
NJMOP277GE* NJMOP277FE*	SOP8 JEDEC150mil	yes	yes	Sn2Bi	277G 277F	76	2,000
NJMOP277GR* NJMOP277FR*	MSOP8 (VSP8)	yes	yes	Sn2Bi	277G 277F	21	2,000
NJMOP2277GE* NJMOP2277FE*	SOP8 JEDEC150mil	yes	yes	Sn2Bi	2277G 2277F	76	2,000
NJMOP2277GR	MSOP8 (VSP8)	yes	yes	Sn2Bi	2277G	21	2,000
NJMOP2277KW2*	DFN8-W2 (ESON8-W2)	yes	yes	Sn2Bi	2277	18	1,500

■ ABSOLUTE MAXIMUM RATINGS

PARAMETER	SYMBOL	RATINGS	UNIT
Supply Voltage	$V^+ - V^-$	+40	V
Differential Input Voltage ⁽¹⁾	V_{ID}	± 40 ⁽²⁾	V
Input Voltage ⁽³⁾	V_{IN}	$V^- - 0.3$ to $V^+ + 0.3$	V
Input Current ⁽⁴⁾	I_{IN}	10	mA
Output Short-Circuit Duration ⁽⁵⁾	-	Infinite ($T_a \leq 25^\circ\text{C}$)	-
Power Dissipation ($T_a=25^\circ\text{C}$)	P_D	NJMOP277	mW
		(2-layer / 4-layer)	
		700 / 1000	
		500 / 660	
SOP8 JEDEC150mil ⁽⁶⁾			
MSOP8 (VSP8) ⁽⁶⁾		800 / 1200	
DFN8-W2 (ESON8-W2) ⁽⁷⁾		600 / 820	
		660 / 2100	
Junction Temperature	T_{jmax}	+150	$^\circ\text{C}$
Storage Temperature Range	T_{stg}	-55 to +150	$^\circ\text{C}$

- (1) Differential voltage is the voltage difference between +INPUT and - INPUT.
 (2) For supply voltage less than +40V, the absolute maximum rating is equal to the supply voltage.
 (3) The absolute maximum input voltage is limited at 40V.
 (4) If the input voltage exceeds the supply voltage, the input current must be limited 10 mA or less by using a restriction resistance.
 (5) Pay careful attention to the total power dissipation not to exceed the absolute maximum ratings, P_D .

■ THERMAL CHARACTERISTICS

PARAMETER	SYMBOL	VALUE		UNIT
Junction-to-ambient thermal resistance	θ_{ja}	NJMOP277	NJMOP2277	$^\circ\text{C} / \text{W}$
		(2-layer / 4-layer)	(2-layer / 4-layer)	
		181 / 122	160 / 104	
		252 / 189	207 / 152	
SOP8 JEDEC150mil ⁽⁶⁾		-	190 / 58	
MSOP8 (VSP8) ⁽⁶⁾				
DFN8-W2 (ESON8-W2) ⁽⁷⁾				
Junction-to-Top of package characterization parameter	ψ_{jt}	NJMOP277	NJMOP2277	$^\circ\text{C} / \text{W}$
		(2-layer / 4-layer)	(2-layer / 4-layer)	
		32 / 27	16 / 13	
		62 / 53	32 / 24	
SOP8 JEDEC150mil ⁽⁶⁾		-	20 / 7	
MSOP8 (VSP8) ⁽⁶⁾				
DFN8-W2 (ESON8-W2) ⁽⁷⁾				

- (6) Mounted on glass epoxy board. (76.2x114.3x1.6mm: based on EIA/JDEC standard, 2Layers FR4)
 Mounted on glass epoxy board. (76.2x114.3x1.6mm: based on EIA/JDEC standard, 4Layers FR4), internal Cu area: 74.2 x 74.2mm
 (7) Mounted on glass epoxy board. (101.5x114.5x1.6mm: based on EIA/JDEC standard, 2Layers FR-4, with Exposed Pad)
 Mounted on glass epoxy board. (101.5x114.5x1.6mm: based on EIA/JDEC standard, 4Layers FR-4, with Exposed Pad)
 *For 4Layers: Applying 99.5x99.5mm inner Cu area and a thermal via hole to a board based on JEDEC standard JESD51-5)

■ POWER DISSIPATION vs. AMBIENT TEMPERATURE

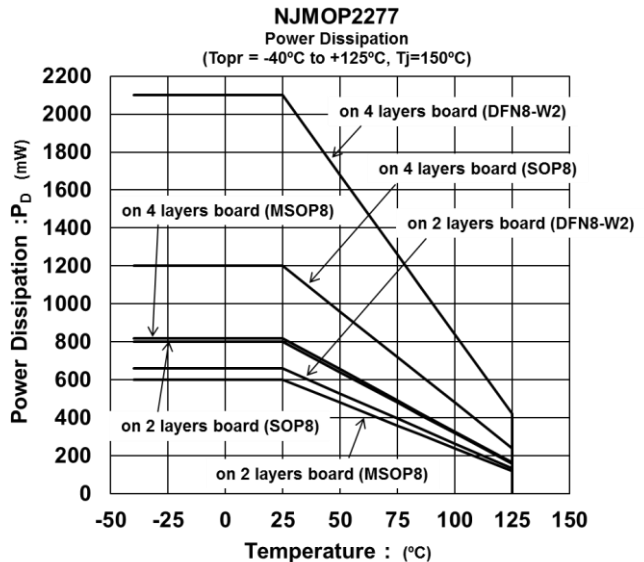
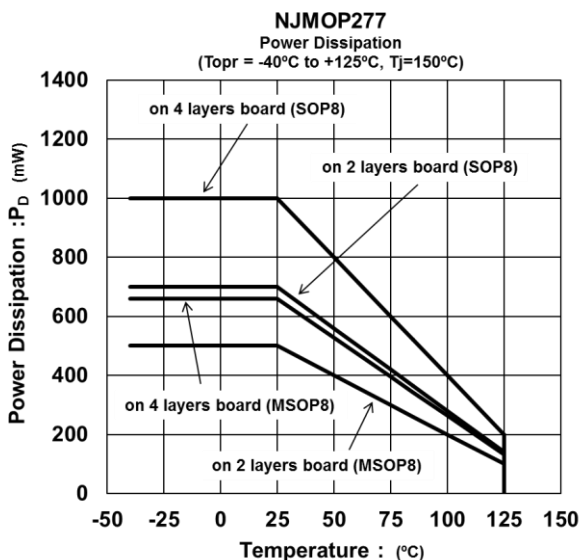

RECOMMENDED OPERATING CONDITIONS

PARAMETER	SYMBOL	RATINGS	UNIT
Supply Voltage Single Supply	$V^+ - V^-$	+4.5 to +36	V
Dual Supply	V^+ / V^-	± 2.25 to ± 18	
Operating Ambient Temperature	T_{opr}	-40 to +125	°C

ELECTRICAL CHARACTERISTICS

(NJMOP277GE* / NJMOP277FE* / NJMOP277GR* / NJMOP277FR*, NJMOP2277GE* / NJMOP2277FE* / NJMOP2277GR)

($V^+ / V^- = \pm 5V$ to $\pm 15V$, $T_a = 25^\circ C$, $V_{COM} = 0V$, unless otherwise noted)

PARAMETER	SYMBOL	TEST CONDITION	MIN.	TYP.	MAX.	UNIT
-----------	--------	----------------	------	------	------	------

INPUT CHARACTERISTICS

Input Offset Voltage	V_{IO}	F-Grade	$V_{COM}=0V, R_s=50\Omega$ $T_a = -40^\circ C$ to $125^\circ C$	-	10	20	μV
		G-Grade	$V_{COM}=0V, R_s=50\Omega$ $T_a = -40^\circ C$ to $125^\circ C$	-	-	50	μV
Input Offset Voltage Drift	$\Delta V_{IO}/\Delta T$	F-Grade	$V_{COM}=0V, R_s=50\Omega, T_a = -40^\circ C$ to $125^\circ C$	-	0.1	0.15	$\mu V/^\circ C$
		G-Grade		-	0.1	0.6	$\mu V/^\circ C$
Input Bias Current	I_B	$V_{COM}=0V$ $T_a = -40^\circ C$ to $125^\circ C$		-	0.5	2.5	nA
				-	-	4	nA
Input Offset Current	I_{IO}	F-Grade	$V_{COM}=0V$ $T_a = -40^\circ C$ to $125^\circ C$	-	0.5	1	nA
		G-Grade	$V_{COM}=0V$ $T_a = -40^\circ C$ to $125^\circ C$	-	-	2	nA
Open-Loop Voltage Gain	A_{V1}	$V_O=(V+0.5V)$ to $(V^- - 1.5V)$ $R_L=10k\Omega$ to $0V$		126	140	-	dB
	A_{V2}	$V_O=(V+1.5V)$ to $(V^- - 2V)$, $R_L=2k\Omega$ to $0V$ $T_a = -40^\circ C$ to $125^\circ C$		126 120	134 -	- -	dB
Common-Mode Rejection Ratio	CMR	$V_{ICM}=(V+2V)$ to $(V^- - 2V)$ $T_a = -40^\circ C$ to $125^\circ C$		115 115	140 -	- -	dB
Common-Mode Input Voltage Range	V_{ICM}	$CMR \geq 115dB$ $T_a = -40^\circ C$ to $125^\circ C$		$V+2$ $V+2$	- -	V^+-2 V^+-2	V V

OUTPUT CHARACTERISTICS

High-level Output Voltage	V_{OH1}	$R_L=10k\Omega$ to $0V$ $T_a = -40^\circ C$ to $125^\circ C$	$V^+-1.5$ $V^+-1.5$	$V^+-1.25$ -	- -	V V
	V_{OH2}	$R_L=2k\Omega$ to $0V$ $T_a = -40^\circ C$ to $125^\circ C$	V^+-2 V^+-2	$V^+-1.3$ -	- -	V V
Low-level Output Voltage	V_{OL1}	$R_L=10k\Omega$ to $0V$ $T_a = -40^\circ C$ to $125^\circ C$	- -	$V+0.2$ -	$V+0.5$ $V+0.5$	V V
	V_{OL2}	$R_L=2k\Omega$ to $0V$ $T_a = -40^\circ C$ to $125^\circ C$	- -	$V+0.5$ -	$V+1.5$ $V+1.5$	V V
Short-circuit Output Current	I_{SC}	Short to $0V$	-	± 30	-	mA

POWER SUPPLY CHARACTERISTICS

Supply Current per Channel	I_{SUPPLY}	No Signal, $R_L=OPEN$ $T_a = -40^\circ C$ to $125^\circ C$	- -	760 -	800 900	μA μA
Supply Voltage Rejection Ratio	SVR	$V^+ / V^- = \pm 2.25V$ to $\pm 15V$ $T_a = -40^\circ C$ to $125^\circ C$	120 120	140 -	- -	dB dB

■ELECTRICAL CHARACTERISTICS

(NJMOP277GE*/NJMOP277FE*/NJMOP277GR*/NJMOP277FR*, NJMOP2277GE*/NJMOP2277FE*/NJMOP2277GR
continued)

($V^+ / V^- = \pm 5V$ to $\pm 15V$, $T_a = 25^\circ C$, $V_{COM} = 0V$, unless otherwise noted)

PARAMETER	SYMBOL	TEST CONDITION	MIN.	TYP.	MAX.	UNIT
AC CHARACTERISTICS						
Gain Bandwidth Product	GBW	$R_L = 2k\Omega$ to $0V$, $C_L = 20pF$, $f = 10kHz$	-	1	-	MHz
Phase Margin	Φ_m	$R_L = 2k\Omega$ to $0V$, $C_L = 20pF$	-	65	-	deg
Gain Margin	G_m	$R_L = 2k\Omega$ to $0V$, $C_L = 20pF$	-	20	-	dB
Slew Rate	SR	$G_V = 0dB$, $R_L = 2k\Omega$ to $0V$, $C_L = 20pF$ $V_{IN} = 5V_{pp}$	-	0.7	-	V/ μs
Settling Time to 0.1%	t_s	$G_V = 0dB$, $R_L = 2k\Omega$ to $0V$, $C_L = 20pF$ $V_{IN} = 10V_{pp}$	-	14	-	μs
Equivalent Input Noise Voltage	e_n	$f = 1kHz$	-	8	-	nV/\sqrt{Hz}
	V_n	$f = 0.1Hz$ to $10Hz$	-	0.2	-	μV_{pp}
Equivalent Input Noise Current	I_n	$f = 1kHz$	-	0.2	-	pA/\sqrt{Hz}
Total Harmonic Distortion + Noise	THD+N	$G_V = 0dB$, $R_L = 2k\Omega$ to $0V$, $C_L = 20pF$ $V_o = 10V_{pp}$, $f = 1kHz$	-	0.002	-	%
Channel Separation	CS	$f = 1kHz$	-	120	-	dB

■ ELECTRICAL CHARACTERISTICS (NJMOP2277KW2*)

($V^+ / V^- = \pm 5V$ to $\pm 15V$, $T_a = 25^\circ C$, $V_{COM} = 0V$, unless otherwise noted)

PARAMETER	SYMBOL	TEST CONDITION	MIN.	TYP.	MAX.	UNIT
INPUT CHARACTERISTICS						
Input Offset Voltage	V_{IO}	$V_{COM} = 0V, R_S = 50\Omega$	-	20	100	μV
		$T_a = -40^\circ C$ to $125^\circ C$	-	-	150	μV
Input Offset Voltage Drift	$\Delta V_{IO} / \Delta T$	$V_{COM} = 0V, R_S = 50\Omega, T_a = -40^\circ C$ to $125^\circ C$	-	0.15	0.7	$\mu V / ^\circ C$
Input Bias Current	I_B	$V_{COM} = 0V$	-	0.5	2.5	nA
		$T_a = -40^\circ C$ to $125^\circ C$	-	-	6	nA
Input Offset Current	I_{IO}	$V_{COM} = 0V$	-	0.5	2	nA
		$T_a = -40^\circ C$ to $125^\circ C$	-	-	3	nA
Open-Loop Voltage Gain	A_{V1}	$V_O = (V^+ + 0.5V)$ to $(V^+ - 1.5V)$ $R_L = 10k\Omega$ to $0V$	126	140	-	dB
	A_{V2}	$V_O = (V^+ + 1.5V)$ to $(V^+ - 2V)$, $R_L = 2k\Omega$ to $0V$ $T_a = -40^\circ C$ to $125^\circ C$	126 120	134 -	- -	dB
Common-Mode Rejection Ratio	CMR	$V_{ICM} = (V^+ + 2V)$ to $(V^+ - 2V)$ $T_a = -40^\circ C$ to $125^\circ C$	115 115	140 -	- -	dB
Common-Mode Input Voltage Range	V_{ICM}	$CMR \geq 115dB$	$V^+ + 2$	-	$V^+ - 2$	V
		$T_a = -40^\circ C$ to $125^\circ C$	$V^+ + 2$	-	$V^+ - 2$	V
OUTPUT CHARACTERISTICS						
High-level Output Voltage	V_{OH1}	$R_L = 10k\Omega$ to $0V$ $T_a = -40^\circ C$ to $125^\circ C$	$V^+ - 1.5$ $V^+ - 1.5$	$V^+ - 1.25$ -	- -	V V
	V_{OH2}	$R_L = 2k\Omega$ to $0V$ $T_a = -40^\circ C$ to $125^\circ C$	$V^+ - 2$ $V^+ - 2$	$V^+ - 1.3$ -	- -	V V
Low-level Output Voltage	V_{OL1}	$R_L = 10k\Omega$ to $0V$ $T_a = -40^\circ C$ to $125^\circ C$	- -	$V^+ + 0.2$ -	$V^+ + 0.5$ $V^+ + 0.5$	V V
	V_{OL2}	$R_L = 2k\Omega$ to $0V$ $T_a = -40^\circ C$ to $125^\circ C$	- -	$V^+ + 0.5$ -	$V^+ + 1.5$ $V^+ + 1.5$	V V
Short-circuit Output Current	I_{SC}	Short to $0V$	-	± 30	-	mA
POWER SUPPLY CHARACTERISTICS						
Supply Current per Channel	I_{SUPPLY}	No Signal, $R_L = OPEN$	-	760	800	μA
		$T_a = -40^\circ C$ to $125^\circ C$	-	-	900	μA
Supply Voltage Rejection Ratio	SVR	$V^+ / V^- = \pm 2.25V$ to $\pm 15V$	120	140	-	dB
		$T_a = -40^\circ C$ to $125^\circ C$	120	-	-	dB
AC CHARACTERISTICS						
Gain Bandwidth Product	GBW	$R_L = 2k\Omega$ to $0V, C_L = 20pF, f = 10kHz$	-	1	-	MHz
Phase Margin	Φ_m	$R_L = 2k\Omega$ to $0V, C_L = 20pF$	-	65	-	deg
Gain Margin	G_m	$R_L = 2k\Omega$ to $0V, C_L = 20pF$	-	20	-	dB
Slew Rate	SR	$G_V = 0dB, R_L = 2k\Omega$ to $0V, C_L = 20pF$ $V_{IN} = 5V_{pp}$	-	0.7	-	V/ μs
Settling Time to 0.1%	t_s	$G_V = 0dB, R_L = 2k\Omega$ to $0V, C_L = 20pF$ $V_{IN} = 10V_{pp}$	-	14	-	μs
Equivalent Input Noise Voltage	e_n	$f = 1kHz$	-	8	-	nV / \sqrt{Hz}
	V_n	$f = 0.1Hz$ to $10Hz$	-	0.2	-	μV_{pp}
Equivalent Input Noise Current	I_n	$f = 1kHz$	-	0.2	-	pA / \sqrt{Hz}
Total Harmonic Distortion + Noise	THD+N	$G_V = 0dB, R_L = 2k\Omega$ to $0V, C_L = 20pF$ $V_O = 10V_{pp}, f = 1kHz$	-	0.002	-	%
Channel Separation	CS	$f = 1kHz$	-	120	-	dB

■ TYPICAL CHARACTERISTICS

Input Offset Voltage Distribution (MSOP)
 $V^+ / V^- = \pm 15V, T_a = 25^\circ C$

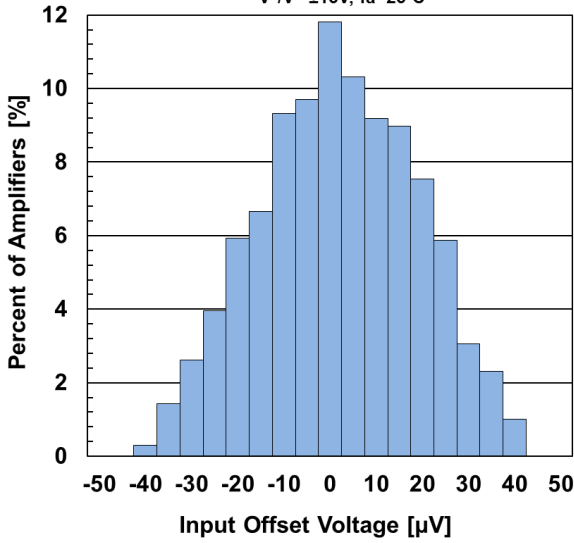

Input Offset Voltage Distribution (MSOP)
 $V^+ / V^- = \pm 5V, T_a = 25^\circ C$

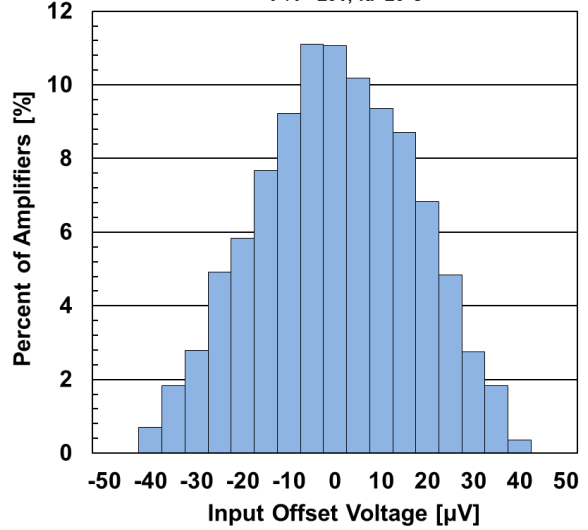

Offset Voltage Drift Distribution (MSOP)
 $V^+ / V^- = \pm 15V, T_a = -40^\circ C \text{ to } +125^\circ C$

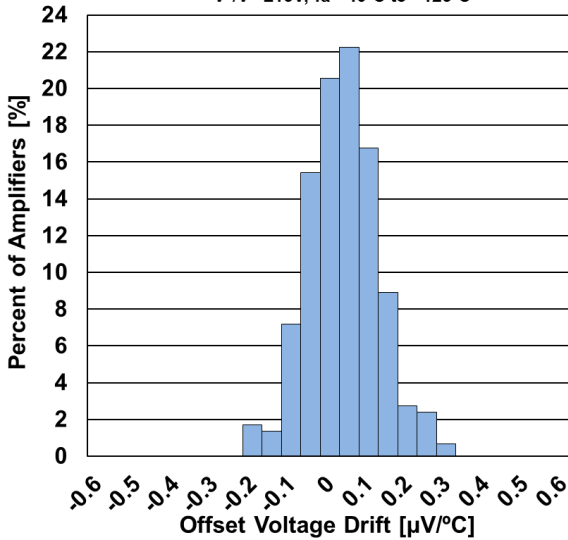

Offset Voltage Drift Distribution (MSOP)
 $V^+ / V^- = \pm 5V, T_a = -40^\circ C \text{ to } +125^\circ C$

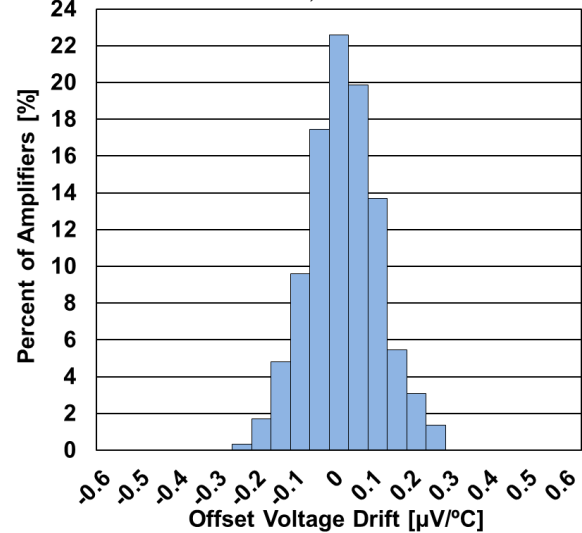

Input Offset Voltage vs. Temperature
 $V^+ / V^- = \pm 15V, V_{COM} = 0V$

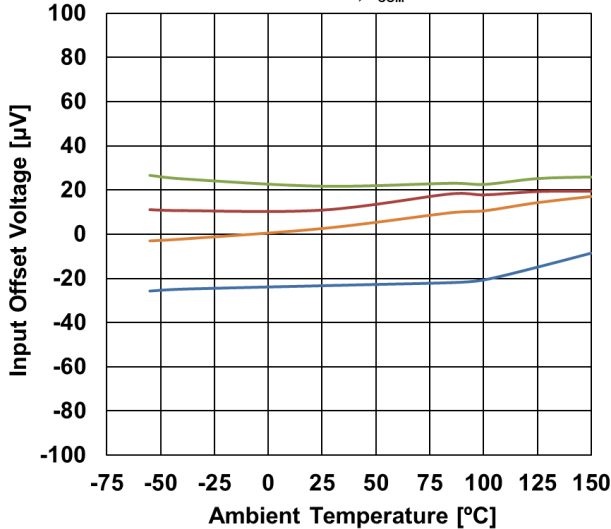

Input Offset Voltage vs. Temperature
 $V^+ / V^- = \pm 5V, V_{COM} = 0V$

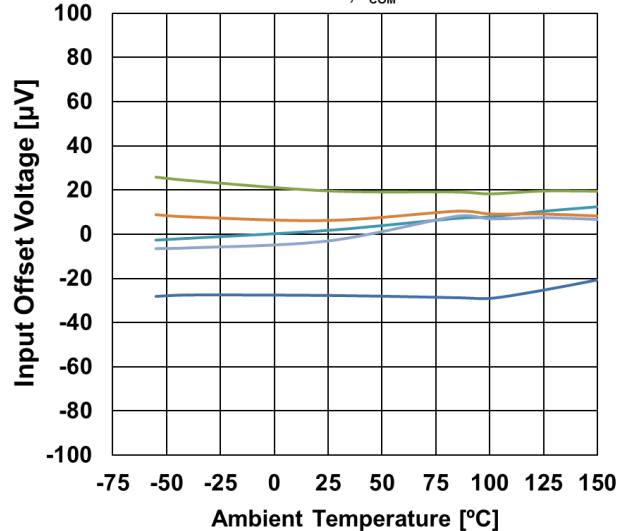

■ TYPICAL CHARACTERISTICS

Input Bias Current vs. Temperature

$V^+ / V^- = \pm 15V, V_{COM} = 0V$

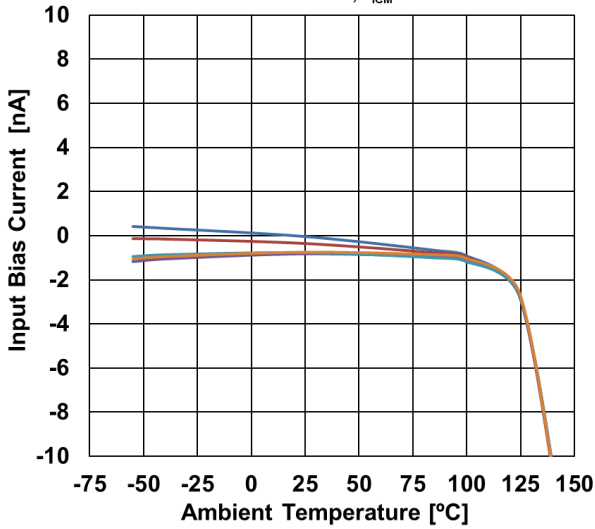

Input Bias Current vs. Temperature

$V^+ / V^- = \pm 5V, V_{COM} = 0V$

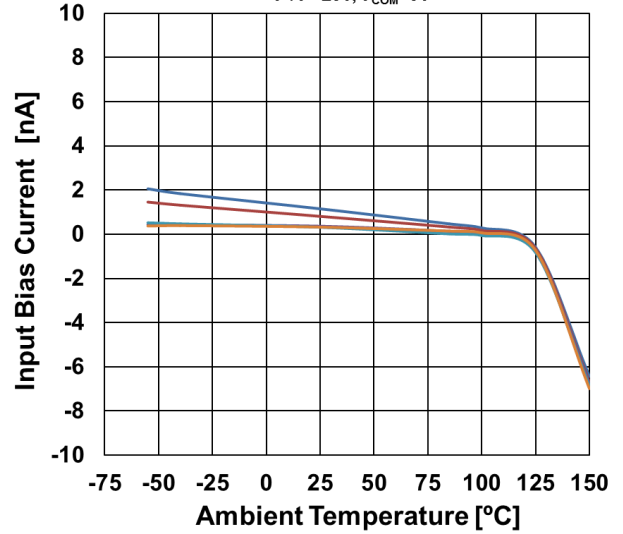

Input Offset Current vs. Temperature

$V^+ / V^- = \pm 15V, V_{COM} = 0V$

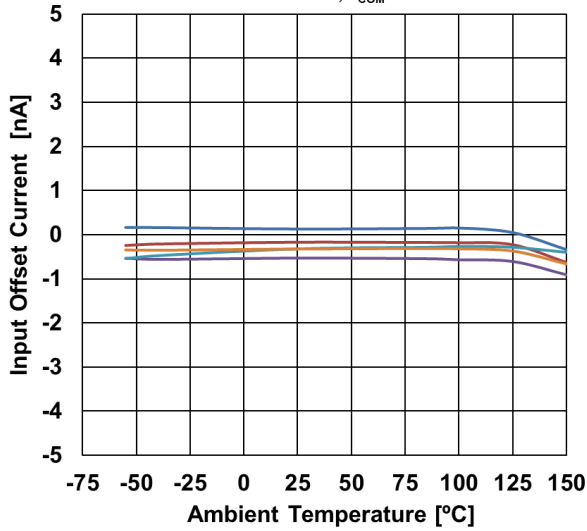

Input Offset Current vs. Temperature

$V^+ / V^- = \pm 5V, V_{COM} = 0V$

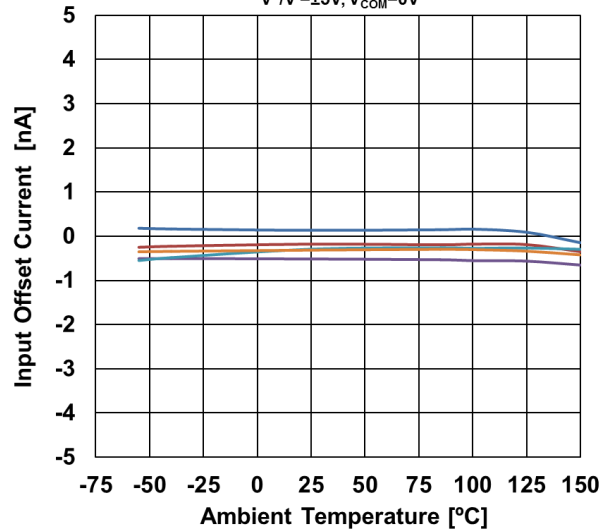

Supply Current vs. Supply Voltage

NJMOP2277, $V_{COM} = 0V, R_L = \text{open}$

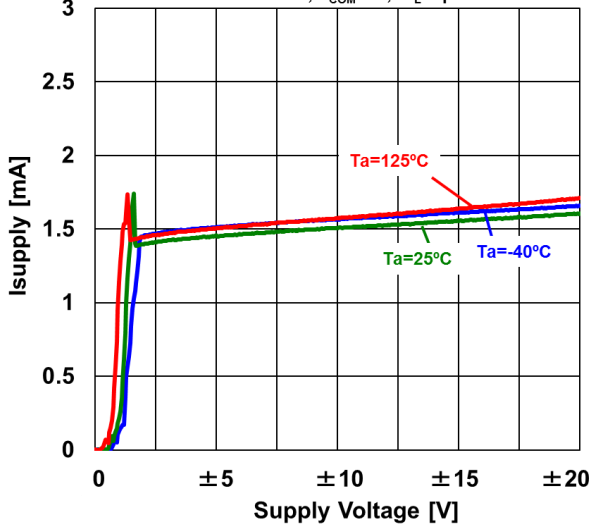

Supply Current vs. Temperature

NJMOP2277, $V_{COM} = 0V, R_L = \text{open}$

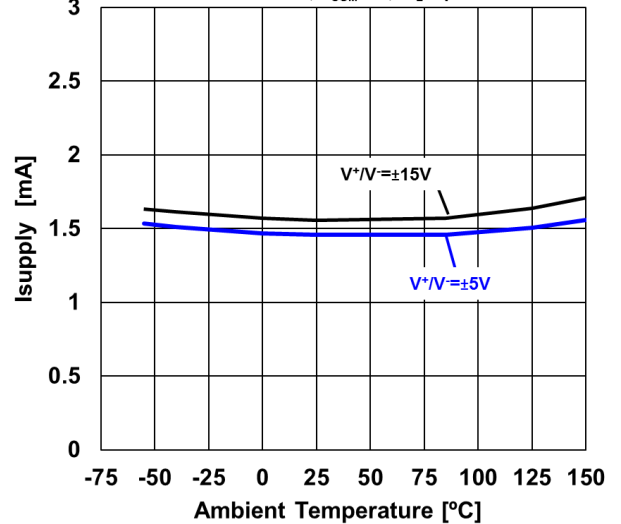

■ TYPICAL CHARACTERISTICS

Open-Loop Voltage Gain vs. Temperature
 $V^+ / V^- = \pm 15V$, $R_L = 2k\Omega$, $V_O = -13.5V$ to $+13V$

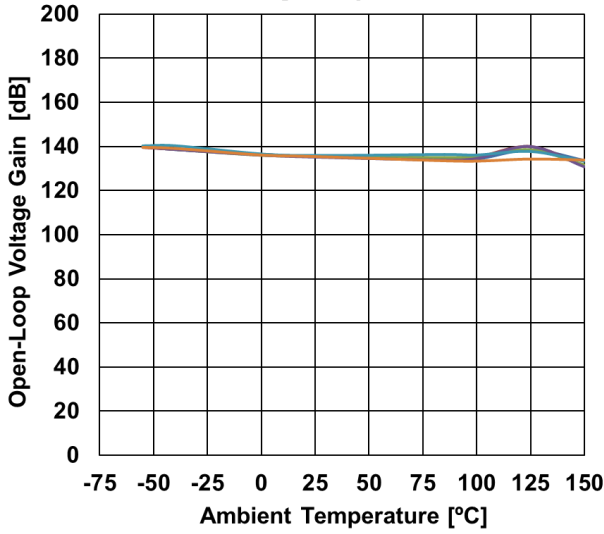

Open-Loop Voltage Gain vs. Temperature
 $V^+ / V^- = \pm 5V$, $R_L = 2k\Omega$, $V_O = -3.5V$ to $+3V$

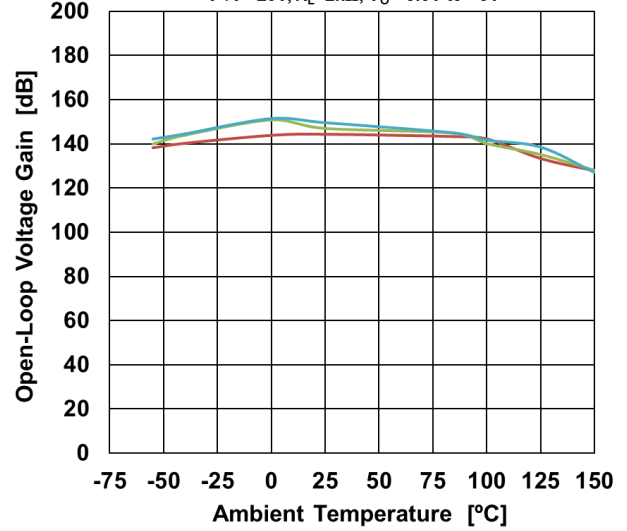

CMR vs. Temperature
 $V^+ / V^- = \pm 15V$, $V_{COM} = -13V$ to $+13V$

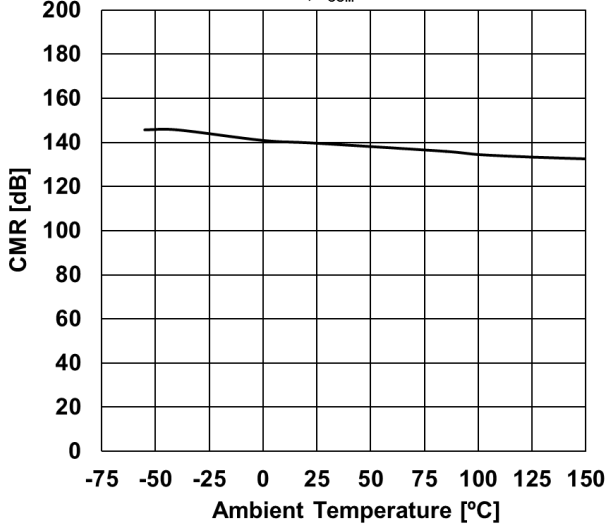

CMR vs. Temperature
 $V^+ / V^- = \pm 5V$, $V_{COM} = -3V$ to $+3V$

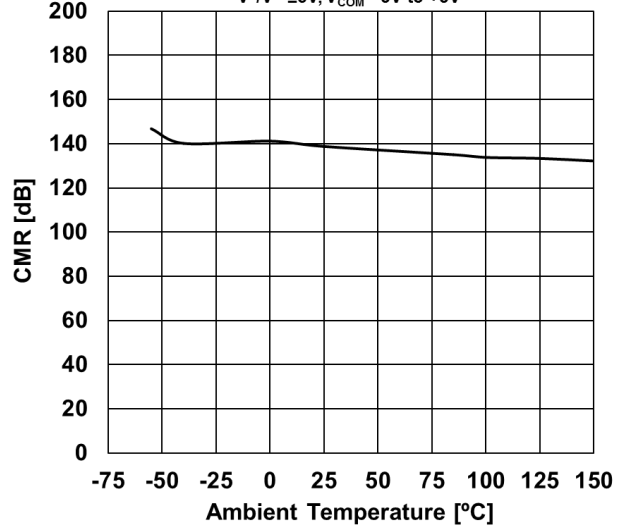

Input Offset Voltage vs. Common-Mode Input Voltage
 $V^+ / V^- = \pm 15V$

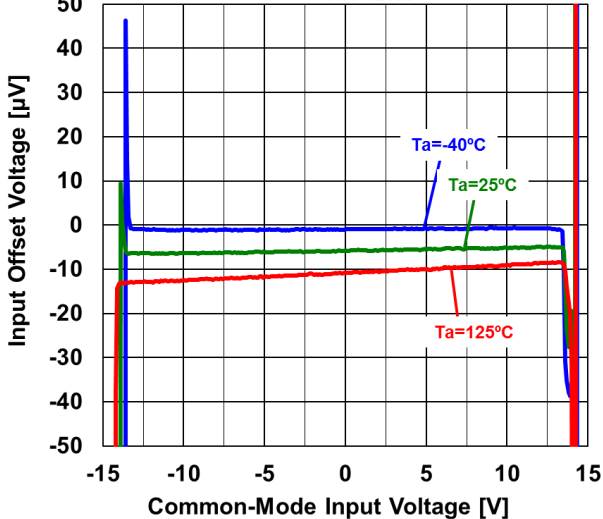

Input Offset Voltage vs. Common-Mode Input Voltage
 $V^+ / V^- = \pm 5V$

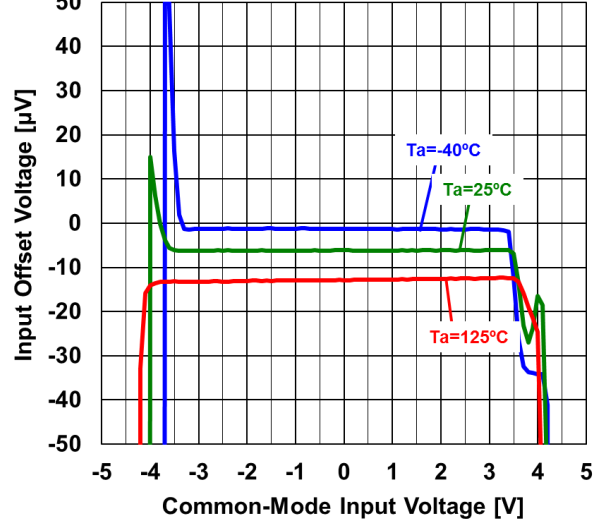

■ TYPICAL CHARACTERISTICS

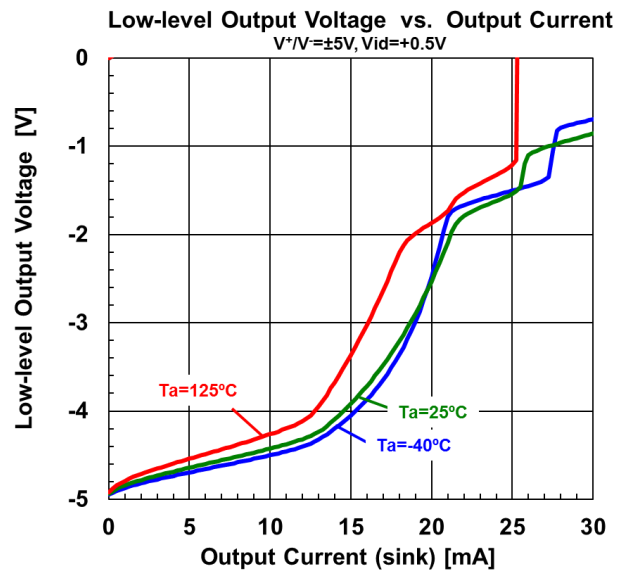
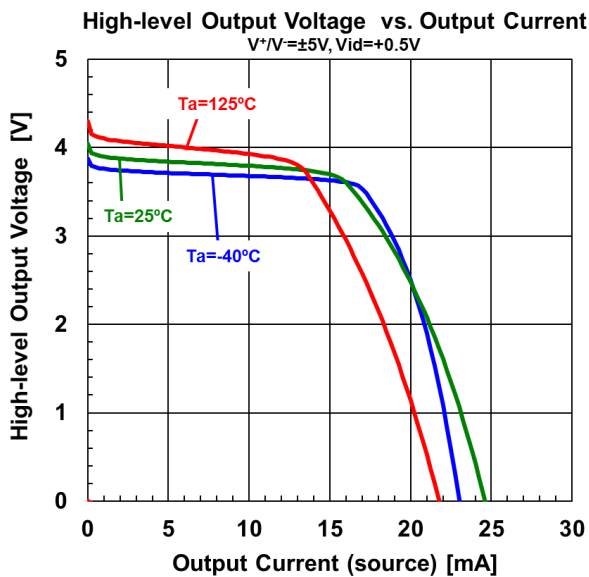
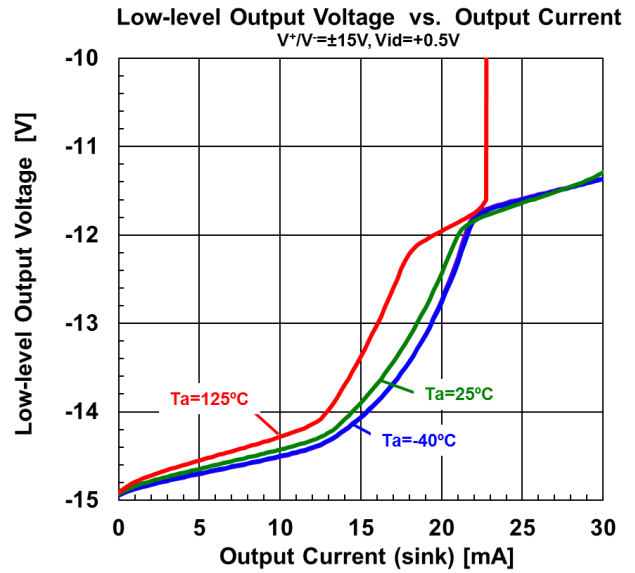
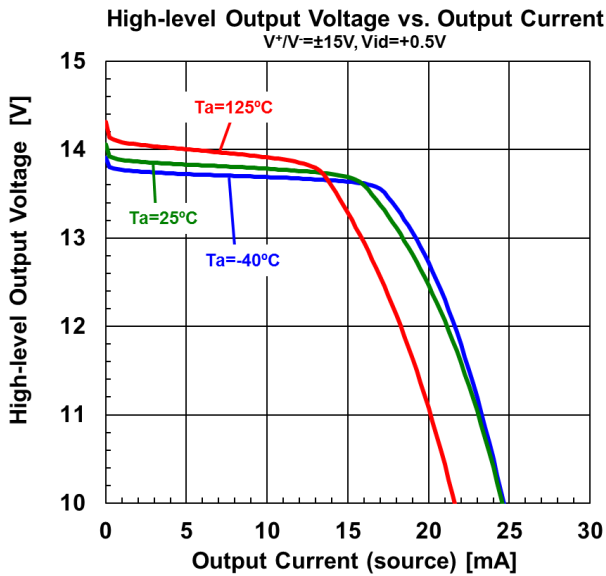
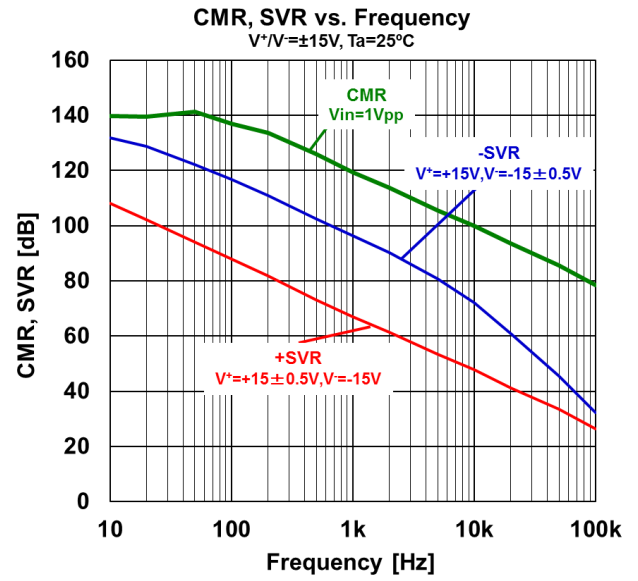
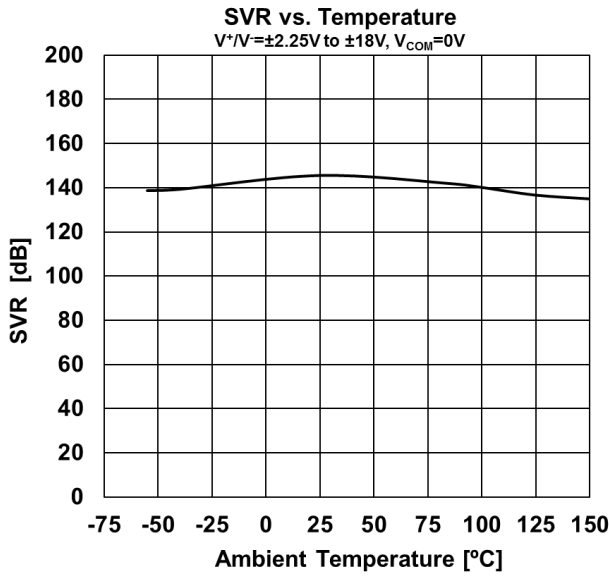

■ TYPICAL CHARACTERISTICS

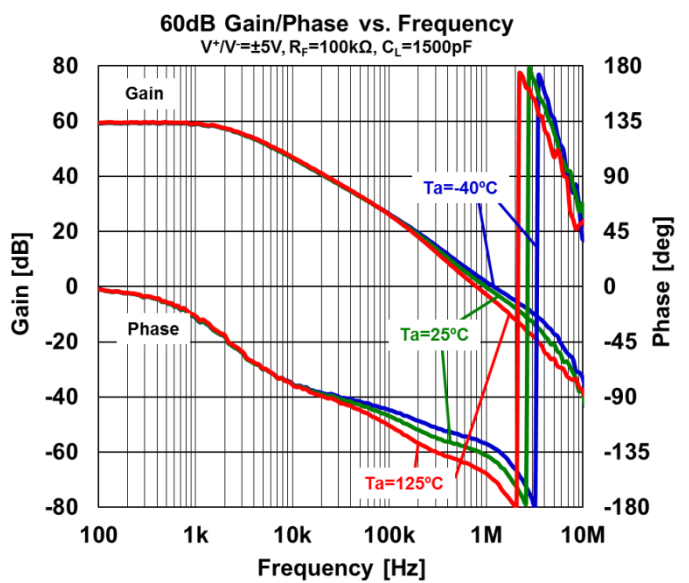
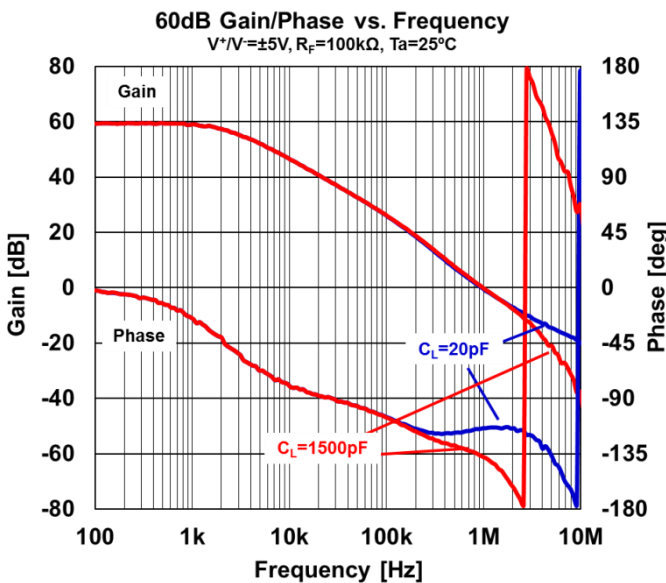
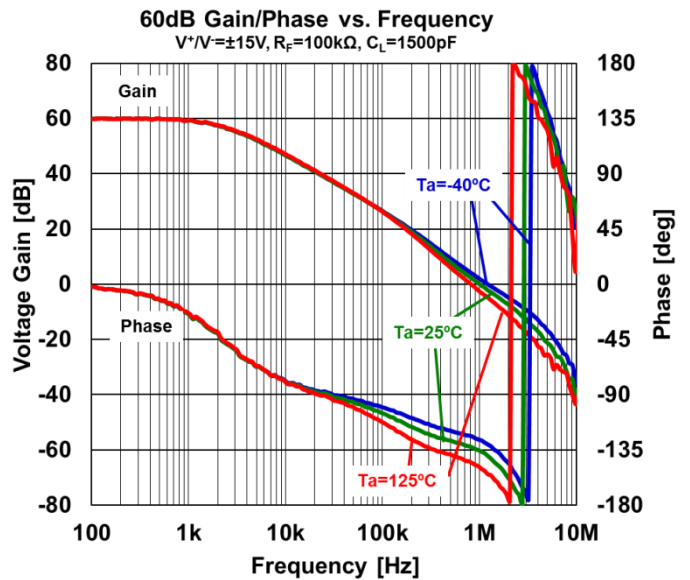
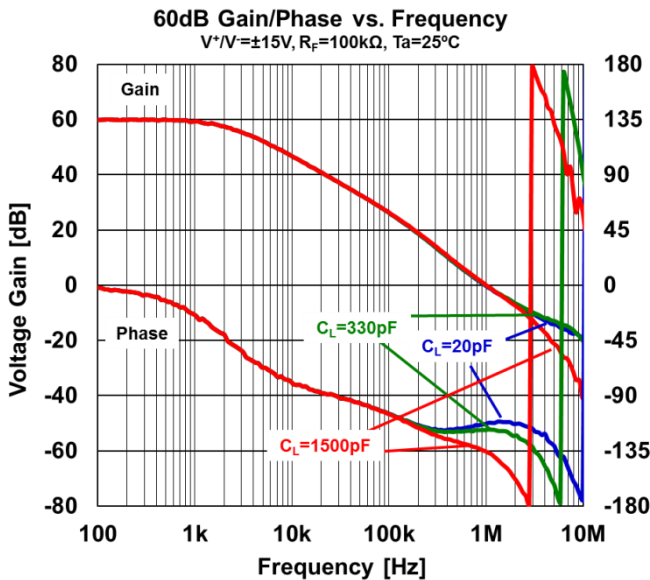
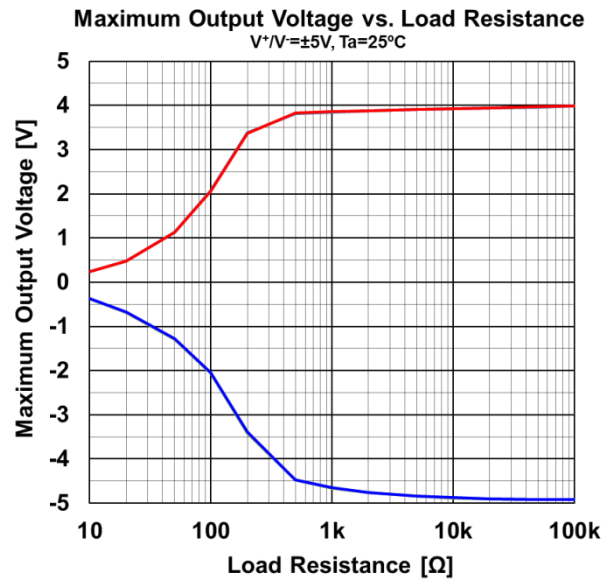
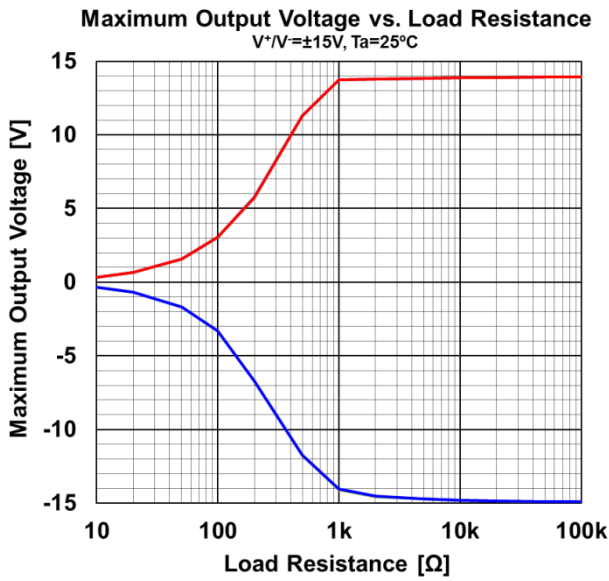

■ TYPICAL CHARACTERISTICS

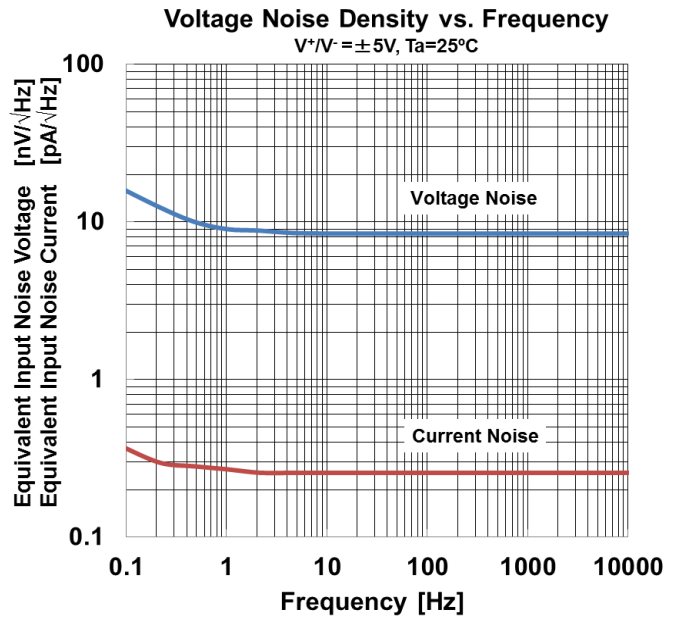
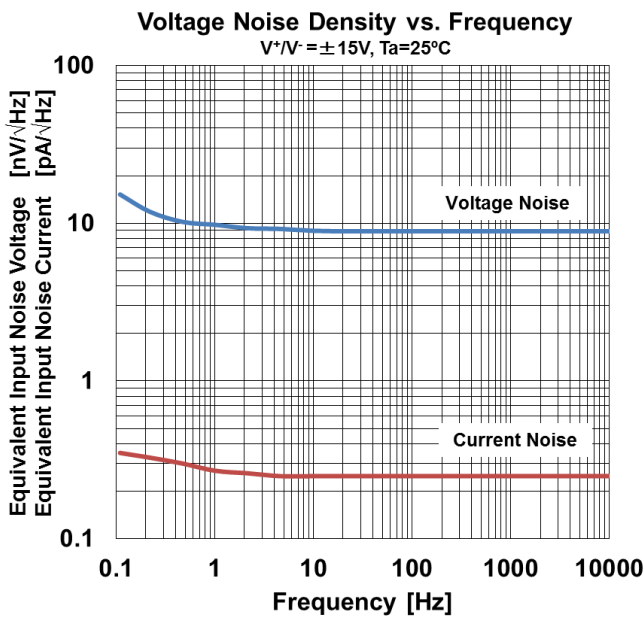
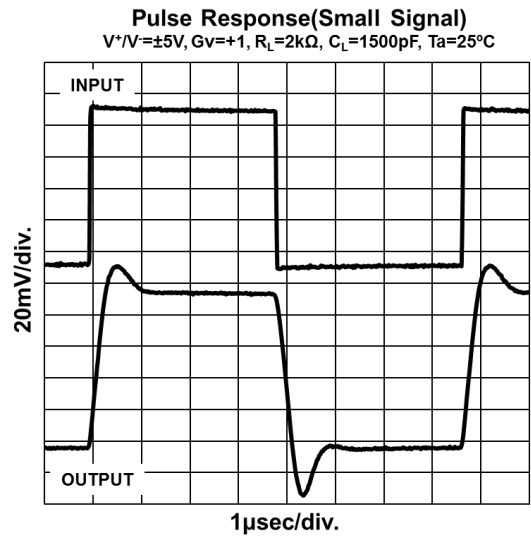
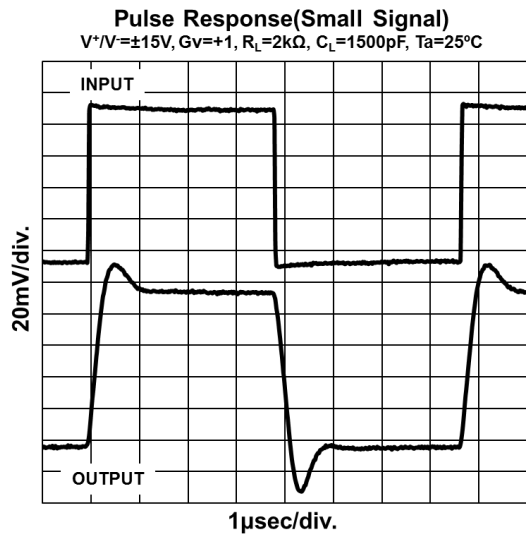
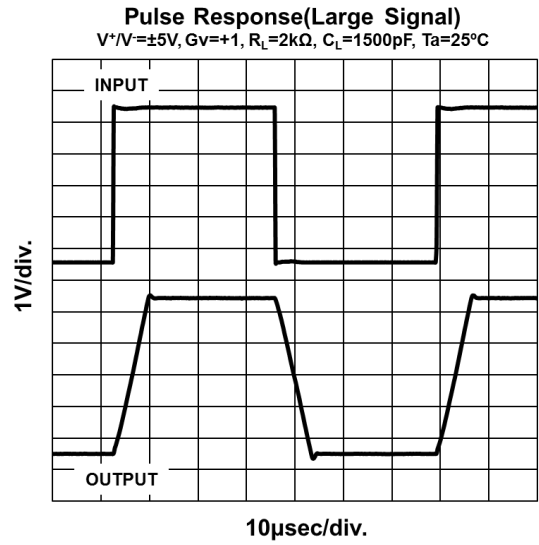
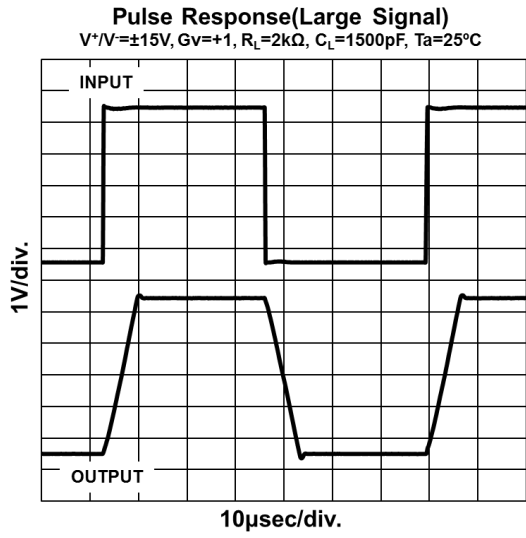

■ TYPICAL CHARACTERISTICS

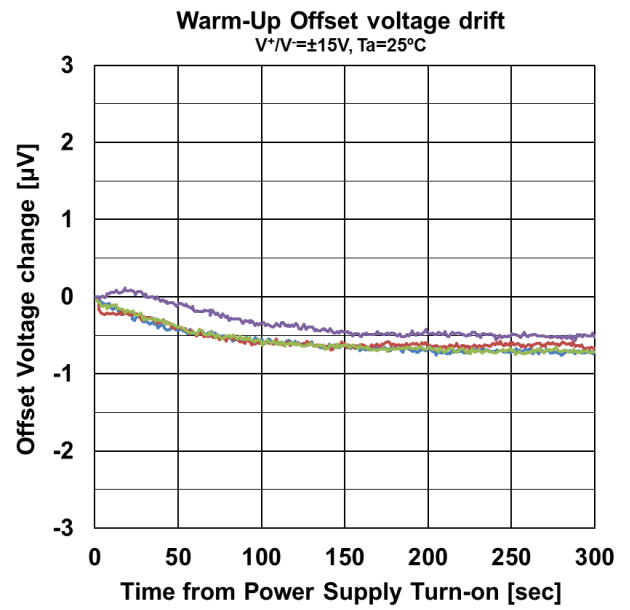
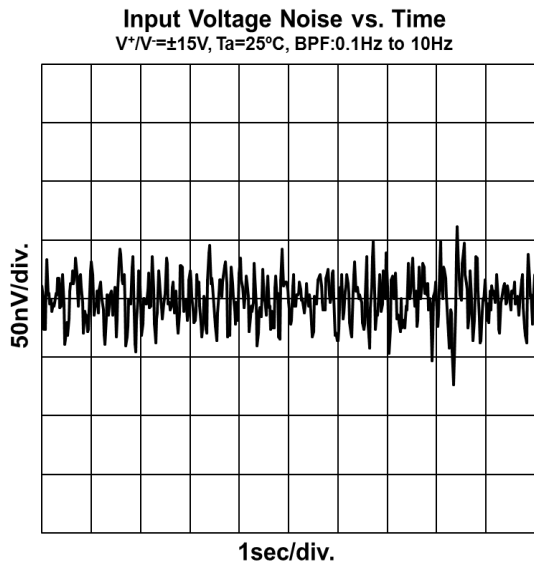

APPLICATION NOTE

Regarding High Precision Operational Amplifier

The NJMOP277 / NJMOP2277 are High Precision Operational Amplifiers featuring low offset voltage and low offset voltage thermal drift. To maximize such a high performance with stable operation, please pay attention to thermocouple effect (Seebeck Effect) and/or Piezo effect.

Thermoelectronic Effect [Seebeck Effect]

The thermoelectromotive force is generated by a temperature gradient when there is contact with dissimilar metals such as relays and switches. The difference in thermoelectromotive force (EMF) between both input pins is output as the input offset voltage. In addition, it is effective to take care to generate an equivalent thermoelectromotive force (EMF) at both input pins in order to reduce the influence of thermoelectromotive force (EMF) on the input offset voltage.

Piezoelectric Effect

When IC is mounted, when stress is applied to the IC, such as warping or bending of the board, a transistor characteristics inside the IC may fluctuate by the piezoelectric effect. Mainly the input offset voltage fluctuates. For high-precision operational amplifiers, chip layout design has been carefully designed to reduce the influence of stress, but the input offset voltage of several μV to several tens μV may fluctuate due to stress at the time of mounting.

Attention: the specification value guarantees the characteristics at the time of factory shipment. The characteristic values after mounting may vary depending on the package type, component placement on the board, material of the board and mounting conditions etc., you should evaluate sufficiently with the actual application.

Power Supply Bypassing

The NJMOP277 / NJMOP2277 are high precision operational amplifier featuring low offset voltage, high voltage gain, high CMR, high SVR and so on. To maximize such a high performance with stable operation, the NJMOP277 / NJMOP2277 should be operated by clean and low impedance supply voltage. So, the bypass capacitor should be connected to these both power supply terminals (V^+ and V^-) as shown in figure1. The bypass capacitors should be placed as close as possible to IC package.

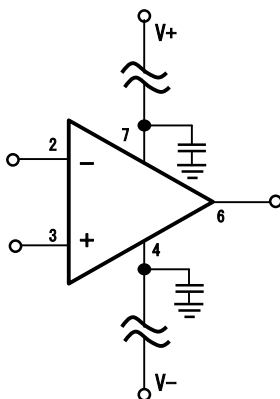

figure1.

Differential Amplifier

NJMOP277 / NJMOP2277 are Operational Amplifier featuring $\text{CMR}=130\text{ dB typ.}$

Differential amplifier (see below figure2) is used in high accuracy circuit to improve common mode rejection ratio (CMR).

A matching between the ratio $R_1/R_2 = R_3/R_4$ and $R_1=R_3$ makes the high CMR. For example, acceptable error range to obtain CMR of 130dB or more is about 0.1ppm.

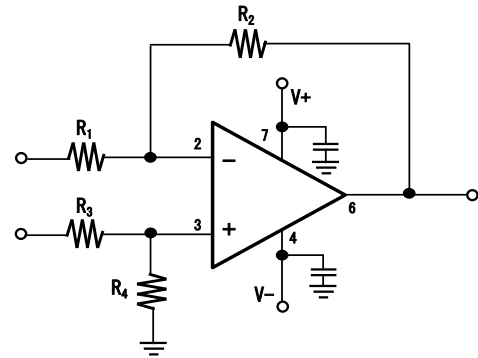

figure2.

Single and Dual Supply Voltage Operation

NJMOP277 / NJMOP2277 works with both single supply and dual supply when the voltage supplied is between V^+ and V^- . These amplifiers operate from single +4.5 to +36V supply and dual $\pm 2, 25\text{V}$ to $\pm 18\text{V}$ supply.

Input Voltage Exceeding the Supply Voltage

NJMOP277 / NJMOP2277 are protected by ESD diodes (shown in figure3) that will conduct if the input voltages exceed the power supplies by more than approximately 300mV. Momentary voltages greater than 300mV beyond the power supply, inputs can be tolerated if the current is limited to 10mA. figure4 is easily accomplished with an input resistor. If the input voltage exceeds the supply voltage, the input current must be limited 10mA or less by using a restriction resistance (R_{LIMIT}) as shown in figure4.

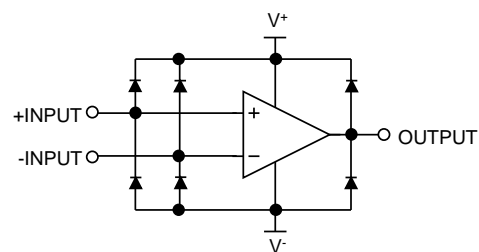

figure3. Simplified Schematic

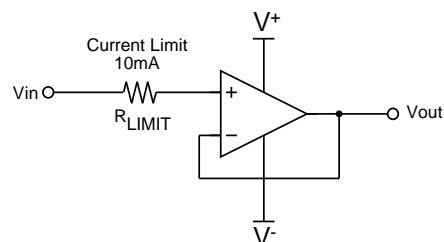

figure4.. Input Current Protection

APPLICATION NOTE

EMIRR(EMI Rejection Ratio) Definition

EMIRR is a parameter indicating the EMI robustness of an OP-Amp. The definition of EMIRR is given by the following a formula (1). We can grasp the tolerance of the RF signal by measuring an RF signal and offset voltage shift quantity.

$$EMIRR = 20 \cdot \log \left(\frac{V_{RF_PEAK}}{|\Delta V_{IO}|} \right) \quad \dots(1)$$

V_{RF_PEAK} : RF Signal Amplitude [V_p]

ΔV_{IO} : Input offset voltage shift quantity [V]

Offset voltage shift is small so that a value of EMIRR is big. And it understands that the tolerance for the RF signal is high. In addition, about the input offset voltage shift with the RF signal, there is the thinking that influence applied to the input terminal is dominant. Therefore, generally the EMIRR becomes value that applied an RF signal to +INPUT terminal.

*For details, refer to " Application Note for EMI Immunity" in our HP: <http://www.njr.com/>

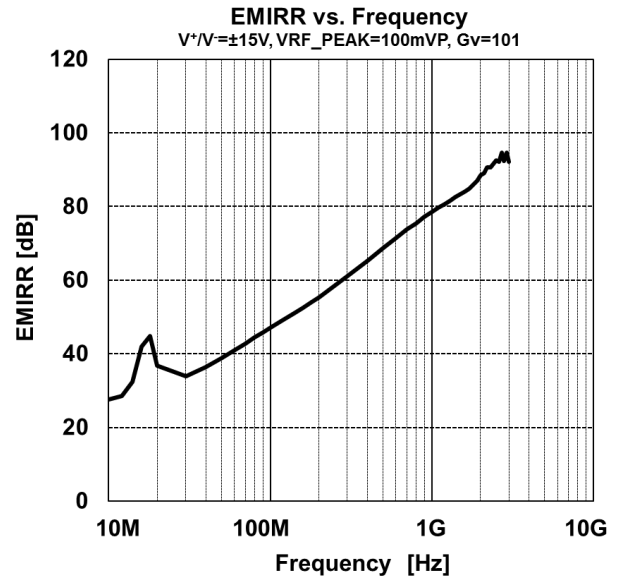

■ TYPICAL TEST CIRCUIT

● Supply Current (I_{SUPPLY})

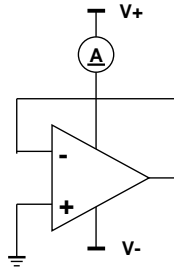

● Output Voltage (V_{OH}, V_{OL})

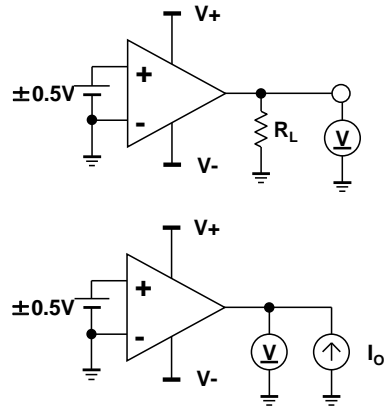

● Input Offset Voltage (V_{IO})

$$R_S=50\Omega, R_F=500k\Omega \quad V_{IO} = \frac{R_S}{R_S + R_F} \times V_O \quad [V]$$

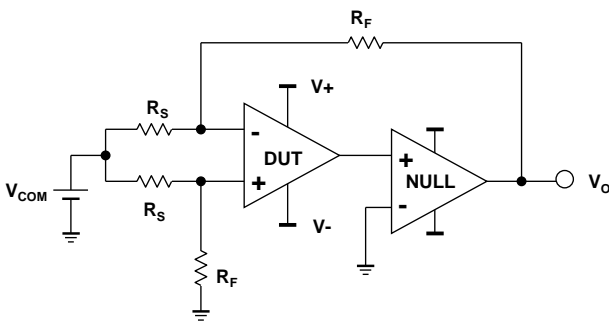

● Slew Rate (SR)

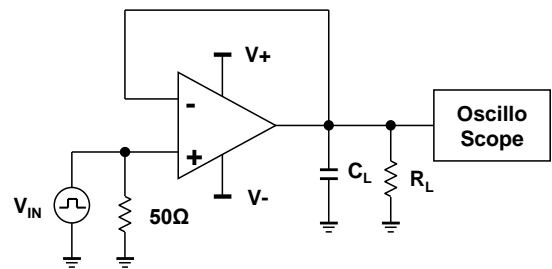

● Gain Bandwidth Product (GBW)

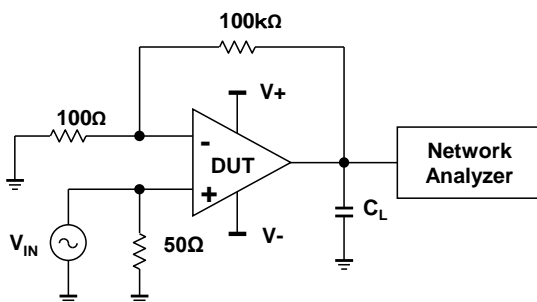

● Equivalent Input Noise Voltage (e_n)

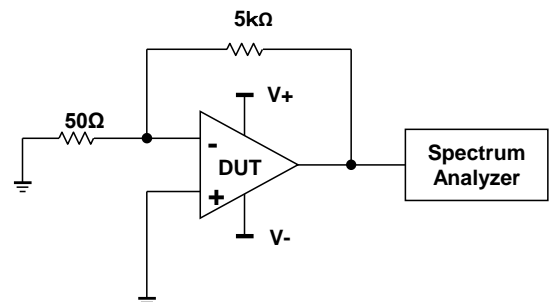

PACKAGE DIMENSIONS

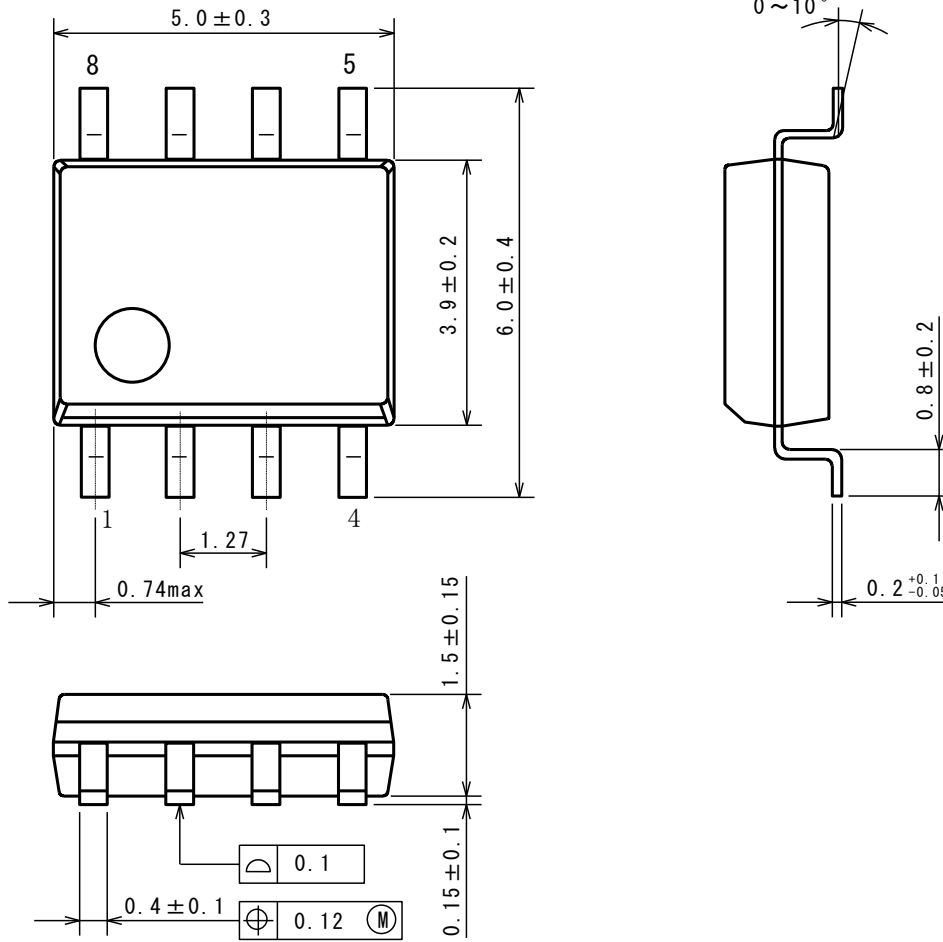

EXAMPLE OF SOLDER PADS DIMENSIONS

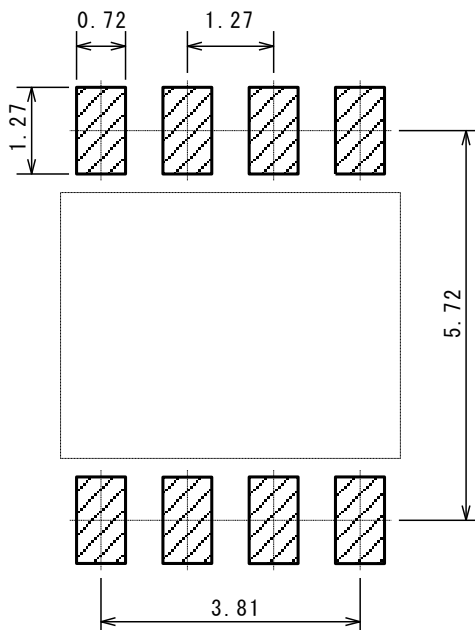

■ PACKAGE DIMENSIONS

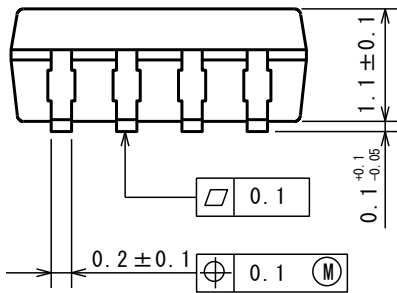
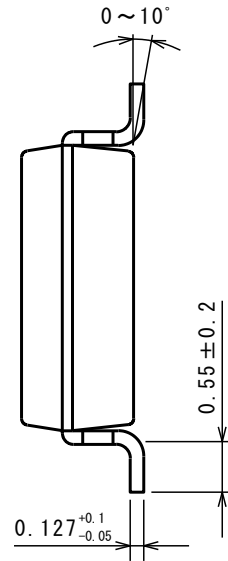
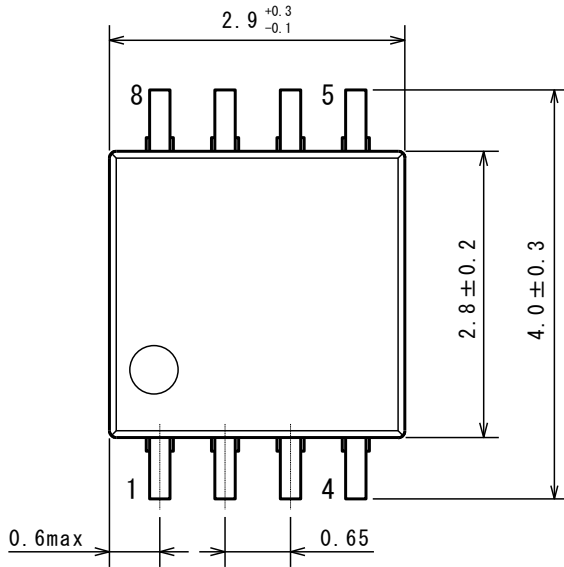

■ EXAMPLE OF SOLDER PADS DIMENSIONS

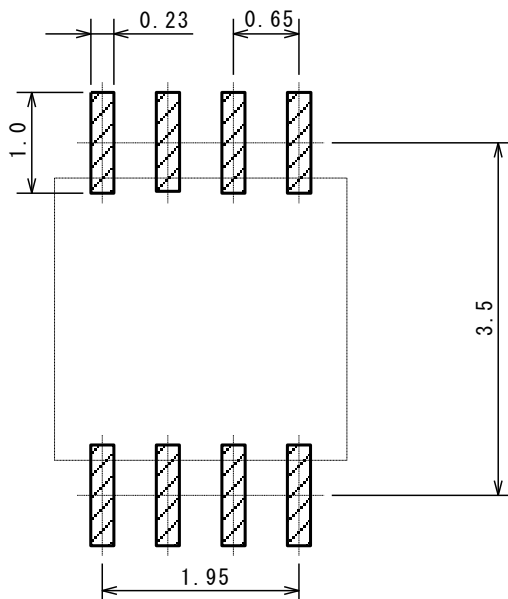

DFN8-W2(ESON8-W2)

Unit: mm

PACKAGE DIMENSIONS

EXAMPLE OF SOLDER PADS DIMENSIONS

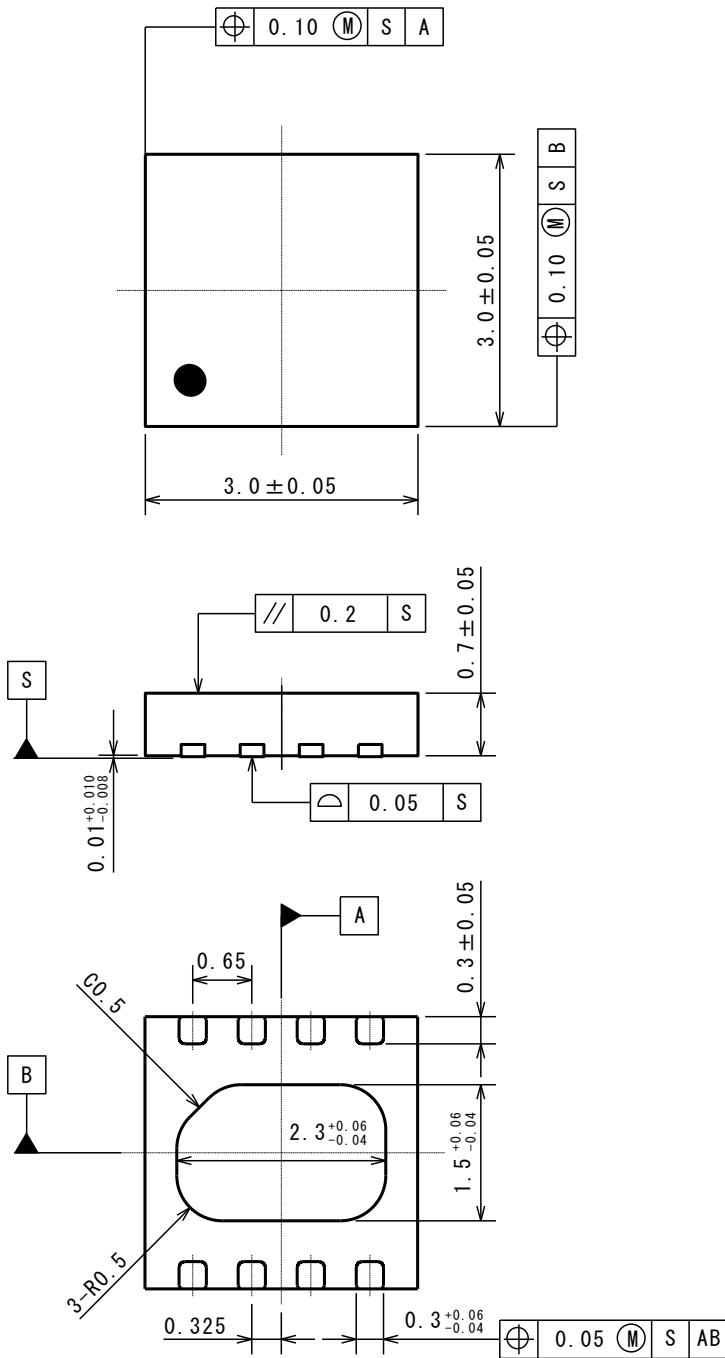

PACKING SPEC

TAPING DIMENSIONS

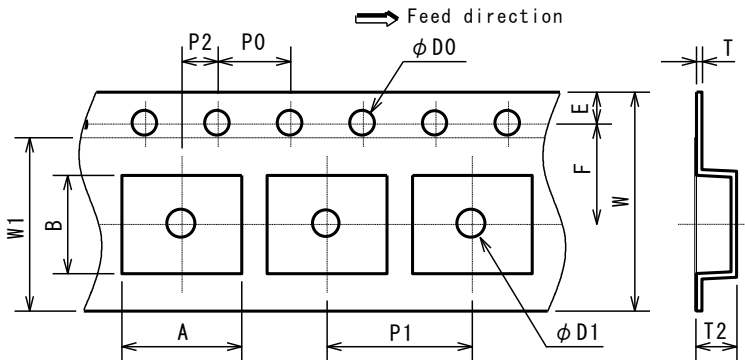

SYMBOL	DIMENSION	REMARKS
A	6.6	BOTTOM DIMENSION
B	5.4	BOTTOM DIMENSION
D0	1.5 ^{+0.1} ₀	
D1	1.7±0.1	
E	1.75±0.1	
F	5.5±0.05	
P0	4.0±0.1	
P1	8.0±0.1	
P2	2.0±0.05	
T	0.30±0.05	
T2	2.2	
W	12.0±0.3	
W1	9.5	THICKNESS 0.1max

REEL DIMENSIONS

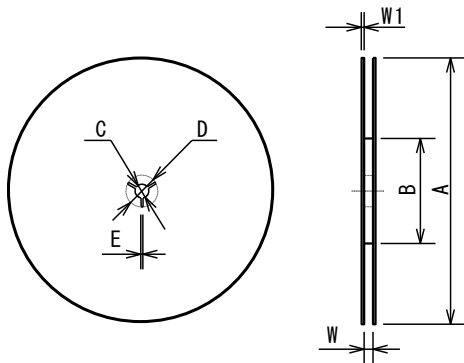

SYMBOL	DIMENSION
A	φ 330±2
B	φ 80±1
C	φ 13±0.2
D	φ 21±0.8
E	2±0.5
W	13.5±0.5
W1	2.0±0.2

TAPING STATE

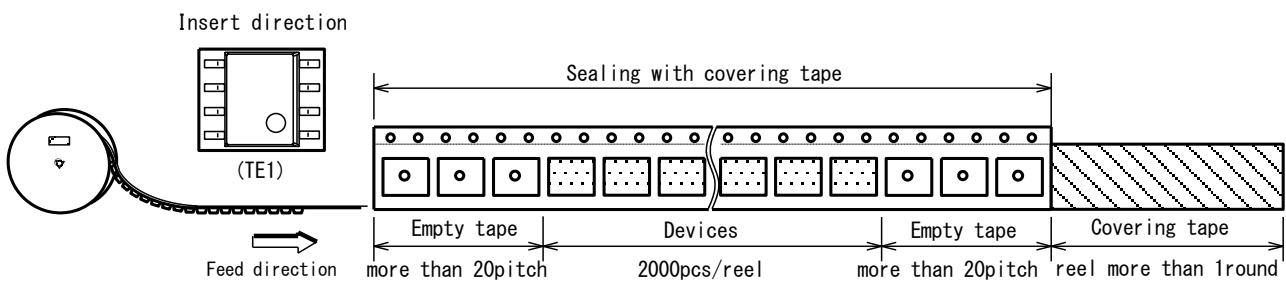

PACKING STATE

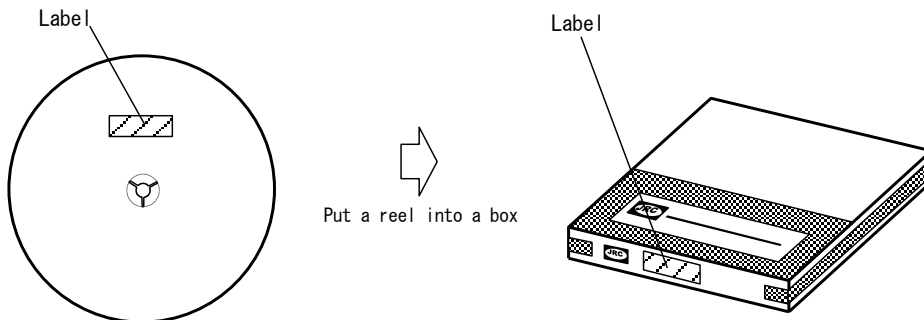

PACKING SPEC

TAPING DIMENSIONS

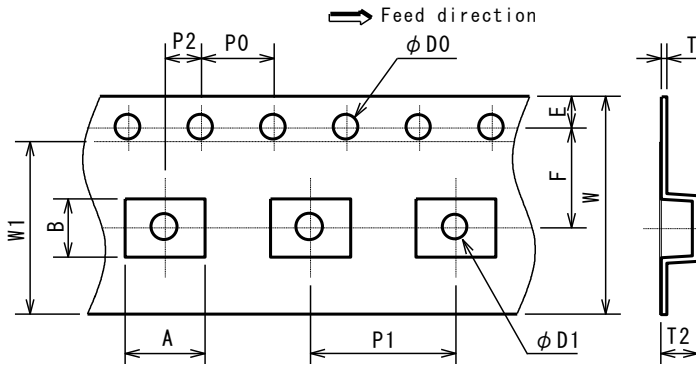

SYMBOL	DIMENSION	REMARKS
A	4.4	BOTTOM DIMENSION
B	3.2	BOTTOM DIMENSION
D0	1.5 ^{+0.1} ₀	
D1	1.5 ^{+0.1} ₀	
E	1.75±0.1	
F	5.5±0.05	
P0	4.0±0.1	
P1	8.0±0.1	
P2	2.0±0.05	
T	0.30±0.05	
T2	2.0 (MAX.)	
W	12.0±0.3	
W1	9.5	THICKNESS 0.1max

REEL DIMENSIONS

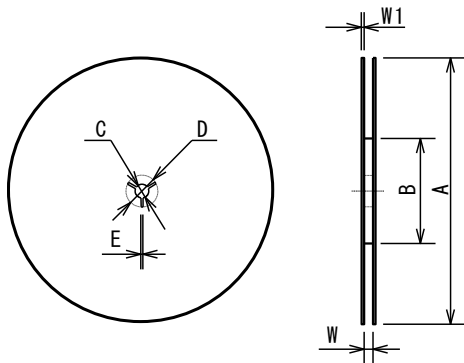

SYMBOL	DIMENSION
A	φ254±2
B	φ100±1
C	φ13±0.2
D	φ21±0.8
E	2±0.5
W	13.5±0.5
W1	2.0±0.2

TAPING STATE

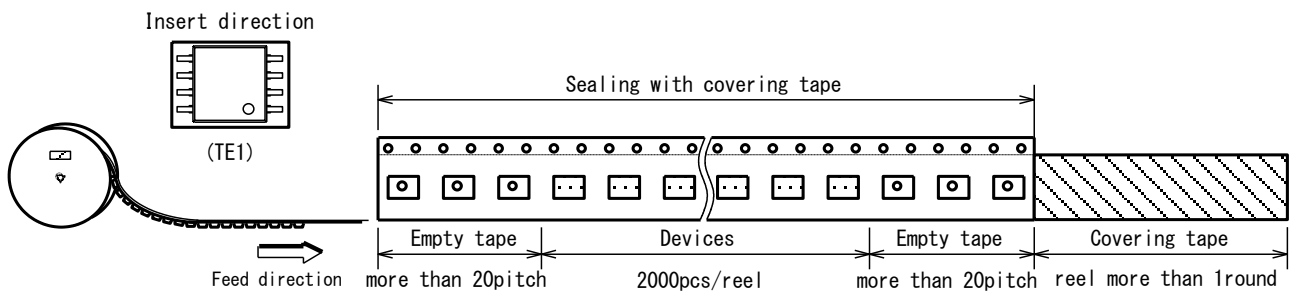

PACKING STATE

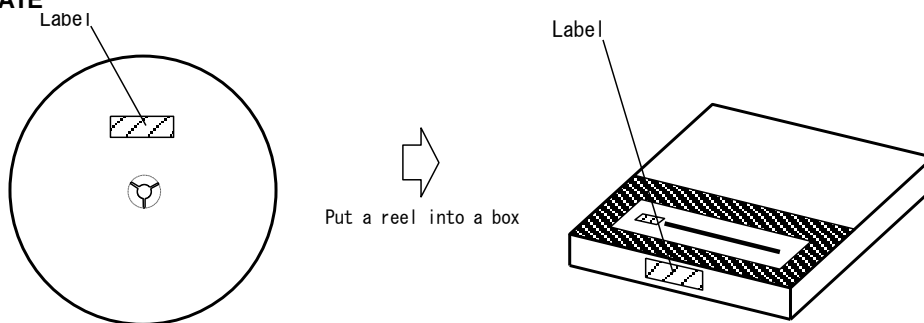

DFN8-W2(ESON8-W2)

Unit: mm

PACKING SPEC

TAPING DIMENSIONS

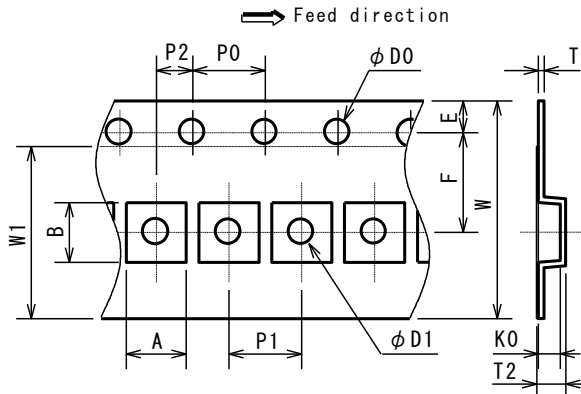

SYMBOL	DIMENSION	REMARKS
A	3.3±0.1	BOTTOM DIMENSION
B	3.3±0.1	BOTTOM DIMENSION
D0	1.5 ^{+0.1} ₀	
D1	1.5 ^{+0.1} ₀	
E	1.75±0.1	
F	5.5±0.05	
P0	4.0±0.1	
P1	8.0±0.1	
P2	2.0±0.05	
T	0.30±0.05	
T2	1.3±0.07	
K0	0.9±0.05	
W	12.0 ^{+0.3} _{-0.1}	
W1	9.5	THICKNESS 0.1max

REEL DIMENSIONS

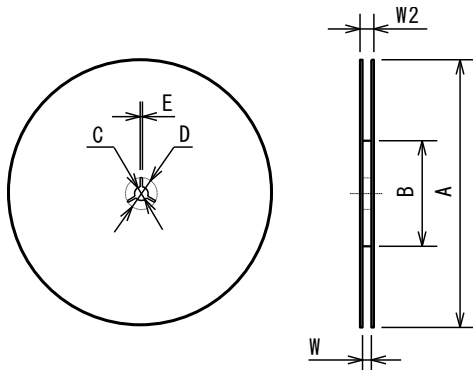

SYMBOL	DIMENSION
A	φ 180 ⁰ ₋₃
B	φ 60 ⁺¹ ₀
C	φ 13±0.2
D	φ 21±0.8
E	2±0.5
W	13 ⁺¹ ₀
W2	15.4±1.0

TAPING STATE

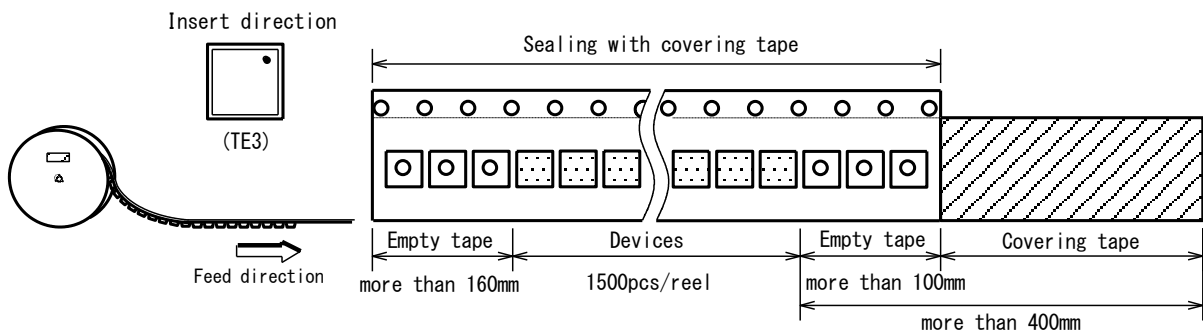

PACKING STATE

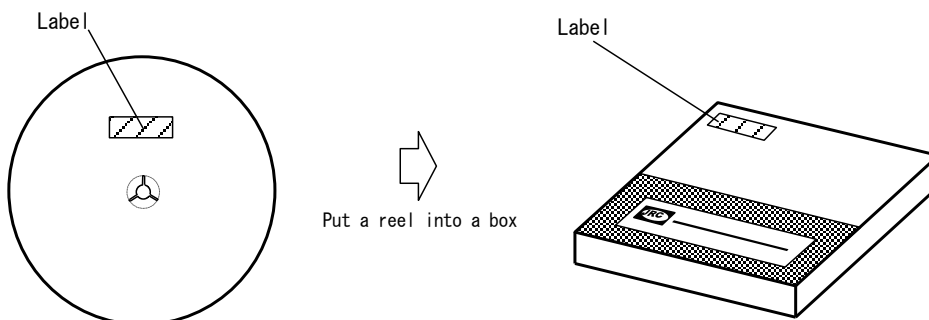

■RECOMMENDED MOUNTING METHOD

*Recommended reflow soldering procedure

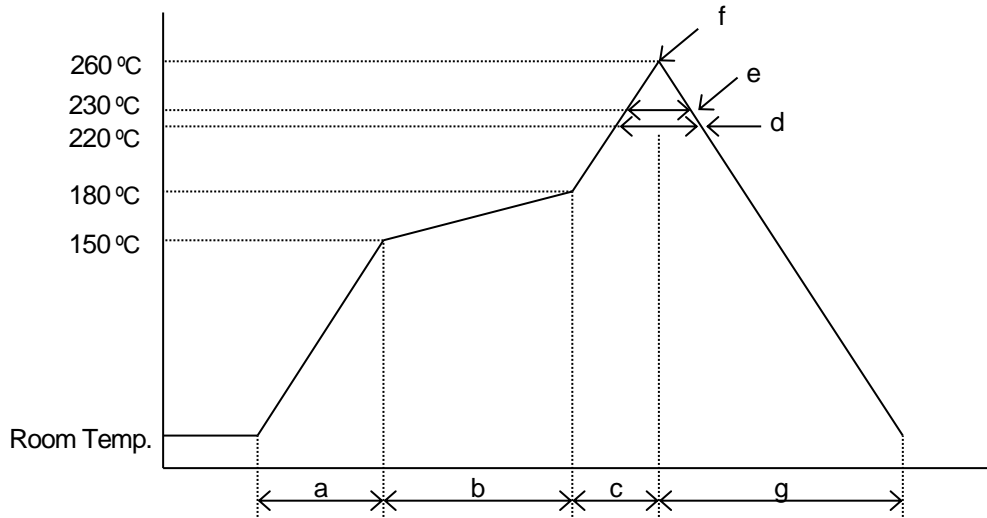

- a : Temperature ramping rate : 1 to 4 °C /s
- b : Pre-heating temperature : 150 to 180 °C
time : 60 to 120s
- c : Temperature ramp rate : 1 to 4 °C /s
- d : 220 °C or higher time : Shorter than 60s
- e : 230 °C or higher time : Shorter than 40s
- f : Peak temperature : Lower than 260 °C
- g : Temperature ramping rate : 1 to 6 °C /s

*The temperature indicates at the surface of mold package.

■REVISION HISTORY

Date	Revision	Changes
2017 / 4 / 6	Ver.1.0	Initial Version
2018 / 1 / 25	Ver.1.1	Update order information

[CAUTION]

1. New JRC strives to produce reliable and high quality semiconductors. New JRC's semiconductors are intended for specific applications and require proper maintenance and handling. To enhance the performance and service of New JRC's semiconductors, the devices, machinery or equipment into which they are integrated should undergo preventative maintenance and inspection at regularly scheduled intervals. Failure to properly maintain equipment and machinery incorporating these products can result in catastrophic system failures
2. The specifications on this datasheet are only given for information without any guarantee as regards either mistakes or omissions. The application circuits in this datasheet are described only to show representative usages of the product and not intended for the guarantee or permission of any right including the industrial rights.
All other trademarks mentioned herein are property of their respective companies.
3. To ensure the highest levels of reliability, New JRC products must always be properly handled.
The introduction of external contaminants (e.g. dust, oil or cosmetics) can result in failures of semiconductor products.
4. New JRC offers a variety of semiconductor products intended for particular applications. It is important that you select the proper component for your intended application. You may contact New JRC's Sale's Office if you are uncertain about the products listed in this catalog.
5. Special care is required in designing devices, machinery or equipment which demand high levels of reliability. This is particularly important when designing critical components or systems whose failure can foreseeably result in situations that could adversely affect health or safety. In designing such critical devices, equipment or machinery, careful consideration should be given to amongst other things, their safety design, fail-safe design, back-up and redundancy systems, and diffusion design.
6. The products listed in the catalog may not be appropriate for use in certain equipment where reliability is critical or where the products may be subjected to extreme conditions. You should consult our sales office before using the products in any of the following types of equipment.

Aerospace Equipment
Equipment Used in the Deep sea
Power Generator Control Equipment (Nuclear, Steam, Hydraulic)
Life Maintenance Medical Equipment
Fire Alarm/Intruder Detector
Vehicle Control Equipment (airplane, railroad, ship, etc.)
Various Safety devices

7. New JRC's products have been designed and tested to function within controlled environmental conditions. Do not use products under conditions that deviate from methods or applications specified in this catalog. Failure to employ New JRC products in the proper applications can lead to deterioration, destruction or failure of the products. New JRC shall not be responsible for any bodily injury, fires or accident, property damage or any consequential damages resulting from misuse or misapplication of its products. Products are sold without warranty of any kind, either express or implied, including but not limited to any implied warranty of merchantability or fitness for a particular purpose.
8. Warning for handling Gallium and Arsenic(GaAs) Products (Applying to GaAs MMIC, Photo Reflector). This Products uses Gallium(Ga) and Arsenic(As) which are specified as poisonous chemicals by law. For the prevention of a hazard, do not burn, destroy, or process chemically to make them as gas or power. When the product is disposed, please follow the related regulation and do not mix this with general industrial waste or household waste.
9. The product specifications and descriptions listed in this catalog are subject to change at any time, without notice.



Mouser Electronics

Authorized Distributor

Click to View Pricing, Inventory, Delivery & Lifecycle Information:

[NJR:](#)

[NJMOP2277FE-TE1](#) [NJMOP2277GE-TE1](#) [NJMOP2277GR-TE1](#) [NJMOP277FE-TE1](#) [NJMOP277FR-TE1](#)
[NJMOP277GE-TE1](#) [NJMOP277GR-TE1](#)



Компания «ЭлектроПласт» предлагает заключение долгосрочных отношений при поставках импортных электронных компонентов на взаимовыгодных условиях!

Наши преимущества:

- Оперативные поставки широкого спектра электронных компонентов отечественного и импортного производства напрямую от производителей и с крупнейших мировых складов;
- Поставка более 17-ти миллионов наименований электронных компонентов;
- Поставка сложных, дефицитных, либо снятых с производства позиций;
- Оперативные сроки поставки под заказ (от 5 рабочих дней);
- Экспресс доставка в любую точку России;
- Техническая поддержка проекта, помощь в подборе аналогов, поставка прототипов;
- Система менеджмента качества сертифицирована по Международному стандарту ISO 9001;
- Лицензия ФСБ на осуществление работ с использованием сведений, составляющих государственную тайну;
- Поставка специализированных компонентов (Xilinx, Altera, Analog Devices, Intersil, Interpoint, Microsemi, Aeroflex, Peregrine, Syfer, Eurofarad, Texas Instrument, Miteq, Cobham, E2V, MA-COM, Hittite, Mini-Circuits, General Dynamics и др.);

Помимо этого, одним из направлений компании «ЭлектроПласт» является направление «Источники питания». Мы предлагаем Вам помощь Конструкторского отдела:

- Подбор оптимального решения, техническое обоснование при выборе компонента;
- Подбор аналогов;
- Консультации по применению компонента;
- Поставка образцов и прототипов;
- Техническая поддержка проекта;
- Защита от снятия компонента с производства.



Как с нами связаться

Телефон: 8 (812) 309 58 32 (многоканальный)

Факс: 8 (812) 320-02-42

Электронная почта: org@eplast1.ru

Адрес: 198099, г. Санкт-Петербург, ул. Калинина, дом 2, корпус 4, литера А.