

## STEP-UP, FOR LCD BIAS SUPPLY, 1-CHANNEL, PWM CONTROL SWITCHING REGULATOR CONTROLLER

[www.sii-ic.com](http://www.sii-ic.com)

© SII Semiconductor Corporation, 2004-2015

Rev.4.2\_01

The S-8333 Series is a CMOS step-up switching regulator which mainly consists of a reference voltage circuit, an oscillator, an error amplifier, a PWM controller, an under voltage lockout circuit (UVLO), and a timer latch short-circuit protection circuit. Because its minimum operating voltage is as low as 1.8 V, this switching regulator is ideal for the power supply of an LCD or for portable systems that operate on a low voltage. The internal oscillation frequency can be set up to 1.08 MHz, via the resistor connected to the ROSC pin.

The maximum duty ratio of PWM control can be controlled by the resistor connected to the RDuty pin. The soft-start function at power application is accomplished by combining the reference voltage control and maximum duty control methods. Even if the voltage of the FB pin is retained lower than the reference voltage due to the factor outside the IC, the output voltage is raised by controlling the maximum duty. The phase compensation and gain value can be adjusted according to the values of the resistor and capacitor connected to the CC pin. Therefore, the operation stability and transient response can be correctly set for each application. The reference voltage accuracy is as high as  $1.0\text{ V} \pm 1.5\%$ , and any voltage can be output by using an external output voltage setting resistor.

In addition, the delay time of the short-circuit protection circuit can be set by using the capacitor connected to the CSP pin. If the maximum duty condition continues because of short-circuiting, the capacitor externally connected to the CSP pin is charged, and oscillation stops after a specific time. The short-circuit protection function is cancelled when the power supply is raised to the UVLO release voltage after it has been lowered to the UVLO detection voltage. A ceramic capacitor or a tantalum capacitor is used as the output capacitor, depending on the setting. This controller IC allows various settings and selections and employs a small package, making it very easy to use.

### ■ Features

- Low voltage operation: 1.8 V to 6.0 V
- Oscillation frequency: 280 kHz to 1.08 MHz (selectable by external resistor)
- Maximum duty: Settable up to 88.5% by external resistor  
47 to 88.5% (oscillation frequency; 500 kHz or more)  
47 to 80% (oscillation frequency; less than 500 kHz)
- Reference voltage:  $1.0\text{ V} \pm 1.5\%$
- Range of operation temperature:  $-40$  to  $+85^\circ\text{C}$
- UVLO (under-voltage lockout) function:  
Detection voltage can be selected from between 1.5 V and 2.3 V in 0.1 V step.  
Hysteresis width can be selected from between 0.1 V and 0.3 V in 0.1 V step.
- Timer latch short-circuit protection circuit:  
Delay time can be set using an external capacitor.
- Soft-start function: Soft-start time can be selected in three steps, 10 ms, 15 ms, and 20 ms.  
Both reference voltage control and maximum duty control methods are applied
- Phase compensation external setting:  
Control is possible via the resistor connected between the CC and GND pins and capacitor
- Lead-free, Sn 100%, halogen-free\*1

\*1. Refer to “■ Product Name Structure” for details.

### ■ Applications

- Power supplies for LCDs and CCDs
- Power supplies for portable equipment

### ■ Packages

- SNT-8A
- 8-Pin TSSOP

■ **Block Diagram**

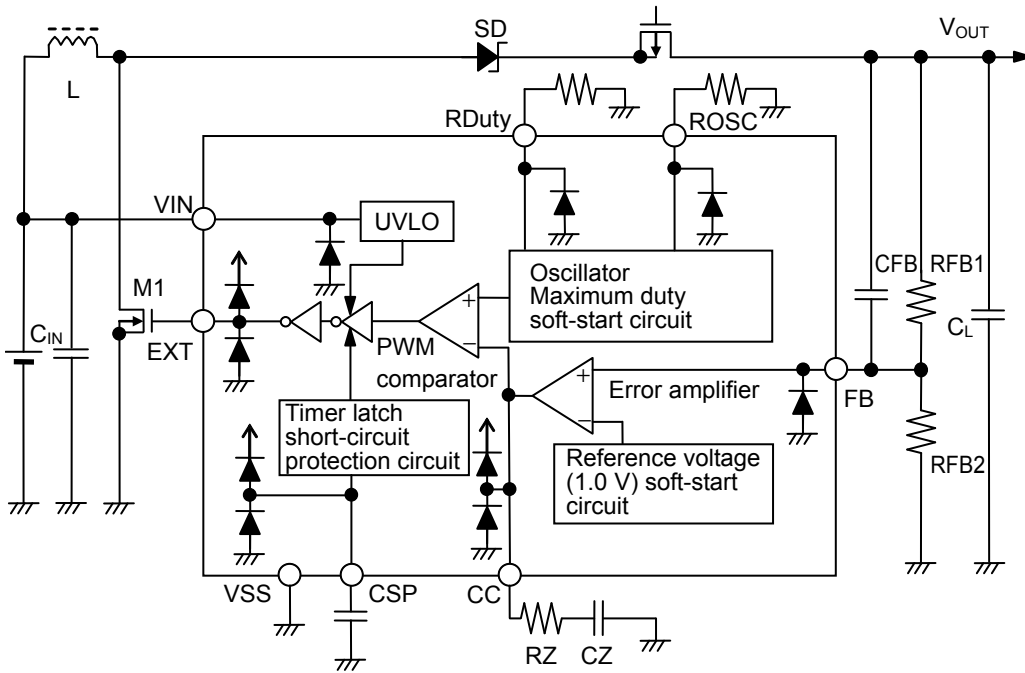

Figure 1 Block Diagram

■ **Product Name Structure**

1. Product name

(1) SNT-8A



\*1. Refer to the tape drawing.

**(2) 8-Pin TSSOP**

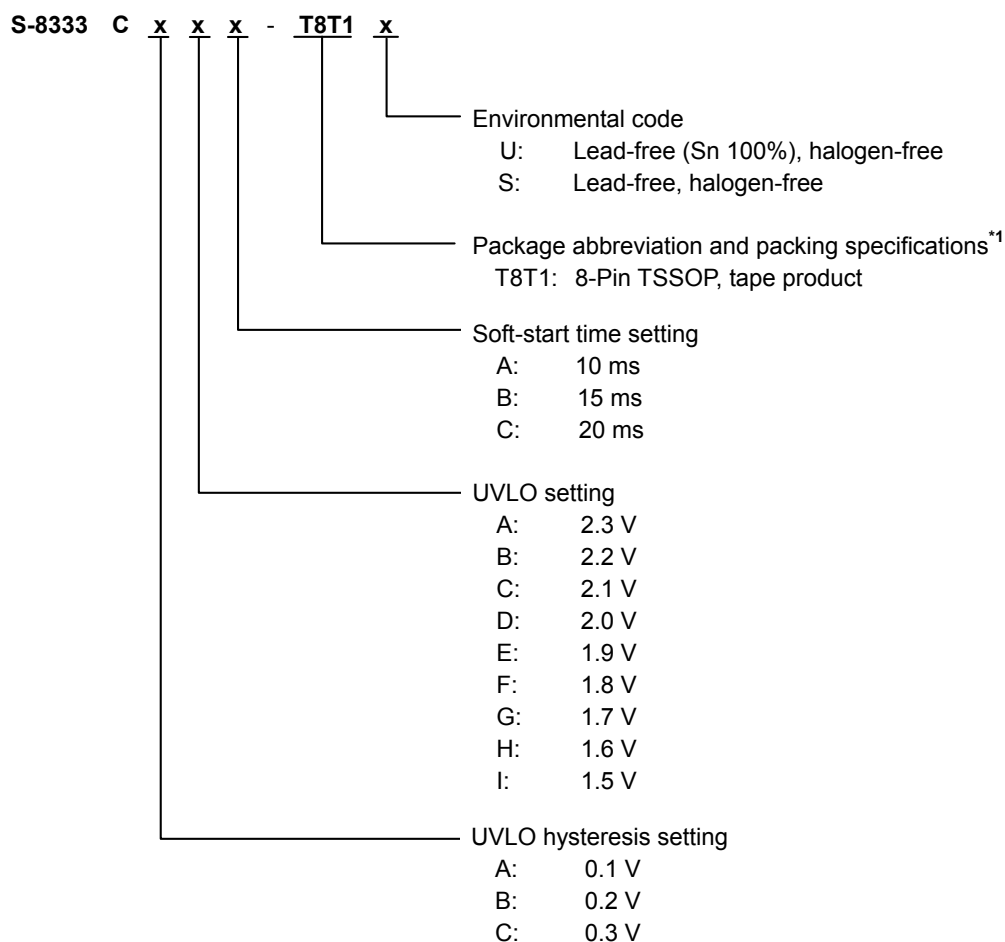

\*1. Refer to the tape drawing.

**2. Packages**

| Package Name | Drawing Code |              |              |              |
|--------------|--------------|--------------|--------------|--------------|
|              | Package      | Tape         | Reel         | Land         |
| SNT-8A       | PH008-A-P-SD | PH008-A-C-SD | PH008-A-R-SD | PH008-A-L-SD |
| 8-Pin TSSOP  | FT008-A-P-SD | FT008-E-C-SD | FT008-E-R-SD | —            |

## ■ Pin Configurations

### 1. SNT-8A



Figure 2

Table 1

| Pin No. | Symbol | Description   |
|---------|--------|---|
| 1       | CC     | Error amplifier circuit output phase compensation pin |
| 2       | FB     | Output voltage feedback pin                           |
| 3       | CSP    | Short-circuit protection delay time setting pin       |
| 4       | VIN    | Power supply input pin                                |
| 5       | EXT    | External transistor connection pin                    |
| 6       | VSS    | GND pin   |
| 7       | ROSC   | Oscillation frequency setting resistor connection pin |
| 8       | RDuty  | Maximum duty setting resistor connection pin          |

### 2. 8-Pin TSSOP



Figure 3

Table 2

| Pin No. | Symbol | Description   |
|---------|--------|---|
| 1       | CC     | Error amplifier circuit output phase compensation pin |
| 2       | FB     | Output voltage feedback pin                           |
| 3       | CSP    | Short-circuit protection delay time setting pin       |
| 4       | VIN    | Power supply input pin                                |
| 5       | EXT    | External transistor connection pin                    |
| 6       | VSS    | GND pin   |
| 7       | ROSC   | Oscillation frequency setting resistor connection pin |
| 8       | RDuty  | Maximum duty setting resistor connection pin          |

■ **Absolute Maximum Ratings**

**Table 3 Absolute Maximum Ratings**

(Unless otherwise specified: Ta = 25°C, V<sub>SS</sub> = 0 V)

| Parameter                     | Symbol             | Ratings  | Unit                            |    |
|-------------------------------|--------------------|--|---------------------------------|----|
| V <sub>IN</sub> pin voltage   | V <sub>IN</sub>    | V <sub>SS</sub> - 0.3 to V <sub>SS</sub> + 6.5 | V                               |    |
| FB pin voltage                | V <sub>FB</sub>    | V <sub>SS</sub> - 0.3 to V <sub>SS</sub> + 6.5 | V                               |    |
| EXT pin voltage               | V <sub>EXT</sub>   | V <sub>SS</sub> - 0.3 to V <sub>IN</sub> + 0.3 | V                               |    |
| CSP pin voltage               | V <sub>CSP</sub>   | V <sub>SS</sub> - 0.3 to V <sub>IN</sub> + 0.3 | V                               |    |
| CC pin voltage                | V <sub>CC</sub>    | V <sub>SS</sub> - 0.3 to V <sub>IN</sub> + 0.3 | V                               |    |
| CC pin current                | I <sub>CC</sub>    | ±10  | mA                              |    |
| ROSC pin voltage              | V <sub>ROSC</sub>  | V <sub>SS</sub> - 0.3 to V <sub>IN</sub> + 0.3 | V                               |    |
| ROSC pin current              | I <sub>ROSC</sub>  | ±10  | mA                              |    |
| RDuty pin voltage             | V <sub>RDuty</sub> | V <sub>SS</sub> - 0.3 to V <sub>IN</sub> + 0.3 | V                               |    |
| RDuty pin current             | I <sub>RDuty</sub> | ±10  | mA                              |    |
| Power dissipation             | P <sub>D</sub>     | SNT-8A   | 450*1                           | mW |
|                               |                    | 8-Pin TSSOP                                    | 300 (When not mounted on board) | mW |
|                               |                    |  | 700*1                           | mW |
| Operating ambient temperature | T <sub>opr</sub>   | -40 to +85                                     | °C                              |    |
| Storage temperature           | T <sub>stg</sub>   | -40 to +125                                    | °C                              |    |

\*1. When mounted on board

[Mounted board]

- (1) Board size: 114.3 mm × 76.2 mm × t1.6 mm
- (2) Name: JEDEC STANDARD51-7

**Caution** The absolute maximum ratings are rated values exceeding which the product could suffer physical damage. These values must therefore not be exceeded under any conditions.



**Figure 4 Power Dissipation of Package (When mounted on board)**

## ■ Electrical Characteristics

**Table 4 Electrical Characteristics**

(Unless otherwise specified:  $V_{IN} = 3.3\text{ V}$ ,  $T_a = 25^\circ\text{C}$ )

| Parameter                                     | Symbol                              | Conditions   | Min.                          | Typ.          | Max.                          | Unit                  | Test Circuit |
|---|-------------------------------------|--|-------------------------------|---------------|-------------------------------|-----------------------|--------------|
| Operating input voltage                       | $V_{IN}$                            | —  | 1.8                           | —             | 6.0                           | V                     | 2            |
| FB voltage                                    | $V_{FB}$                            | —  | 0.985                         | 1.000         | 1.015                         | V                     | 2            |
| Current consumption                           | $I_{SS1}$                           | $f_{osc} = 650\text{ kHz}$<br>$V_{FB} = 0.95\text{ V}$   | —                             | 450           | 700                           | $\mu\text{A}$         | 1            |
| EXT pin output current                        | $I_{EXTH}$                          | $V_{EXT} = V_{IN} - 0.4\text{ V}$  | —                             | -100          | -60                           | mA                    | 1            |
|   | $I_{EXTL}$                          | $V_{EXT} = 0.4\text{ V}$   | 100                           | 160           | —                             | mA                    | 1            |
| FB voltage temperature coefficient            | $\frac{\Delta V_{FB}}{\Delta T_a}$  | $T_a = -40\text{ to }+85^\circ\text{C}$  | —                             | $\pm 100$     | —                             | ppm/ $^\circ\text{C}$ | 2            |
| FB pin input current                          | $I_{FB}$                            | —  | -0.1                          | —             | +0.1                          | $\mu\text{A}$         | 1            |
| Oscillation frequency*1                       | $f_{osc}$                           | When $f_{osc} = 1080\text{ kHz}$ is set<br>( $R_{OSC} = 120\text{ k}\Omega$ )<br>When $f_{osc} = 650\text{ kHz}$ is set<br>( $R_{OSC} = 200\text{ k}\Omega$ )<br>When $f_{osc} = 280\text{ kHz}$ is set<br>( $R_{OSC} = 470\text{ k}\Omega$ )<br>$V_{FB} = 0.9\text{ V}$<br>Waveform on EXT pin is measured. | $f_{osc}$<br>$\times 0.9$     | $f_{osc}$     | $f_{osc}$<br>$\times 1.1$     | kHz                   | 1            |
| Oscillation frequency temperature coefficient | $\frac{\Delta f_{osc}}{\Delta T_a}$ | $T_a = -40\text{ to }+85^\circ\text{C}$<br>$f_{osc} = 650\text{ kHz}$  | —                             | 1000          | —                             | ppm/ $^\circ\text{C}$ | 1            |
| Max. duty*2                                   | MaxDuty                             | $f_{osc} = 1080\text{ kHz}$ ( $R_{OSC} = 120\text{ k}\Omega$ )<br>MaxDuty = 88.5% ( $R_{Duty} = 62\text{ k}\Omega$ )<br>MaxDuty = 73% ( $R_{Duty} = 180\text{ k}\Omega$ )<br>MaxDuty = 47% ( $R_{Duty} = 390\text{ k}\Omega$ )   | MaxDuty<br>- 5                | MaxDuty       | MaxDuty<br>+ 5                | %                     | 1            |
|   |                                     | $f_{osc} = 650\text{ kHz}$ ( $R_{OSC} = 200\text{ k}\Omega$ )<br>MaxDuty = 88.5% ( $R_{Duty} = 100\text{ k}\Omega$ )   |                               |               |                               |                       |              |
| Soft-start time                               | $t_{SS}$                            | $t_{SS} = 10\text{ ms}, 15\text{ ms}, 20\text{ ms}$<br>Selected in three steps   | $t_{SS}$<br>$\times 0.75$     | $t_{SS}$      | $t_{SS}$<br>$\times 1.5$      | ms                    | 1            |
| Short-circuit protection delay time*3         | $t_{PRO}$                           | $t_{PRO} = 50\text{ ms}$<br>(CSP = 0.1 $\mu\text{F}$ )   | 37.5                          | 50            | 75                            | ms                    | 1            |
| UVLO detection voltage                        | $V_{UVLO}$                          | $V_{UVLO} = 1.5\text{ V to }2.3\text{ V}$<br>Selected in 0.1 V steps   | $V_{UVLO}$<br>$\times 0.95$   | $V_{UVLO}$    | $V_{UVLO}$<br>$\times 1.05$   | V                     | 1            |
| UVLO hysteresis width                         | $V_{UVLOHYS}$                       | $V_{UVLOHYS} = 0.1\text{ V to }0.3\text{ V}$<br>Selected in 0.1 V steps  | $V_{UVLOHYS}$<br>$\times 0.6$ | $V_{UVLOHYS}$ | $V_{UVLOHYS}$<br>$\times 1.4$ | V                     | 1            |
| CC pin output current                         | $I_{CCH}$                           | $V_{FB} = 2\text{ V}$  | -60                           | -45           | -34.5                         | $\mu\text{A}$         | 1            |
|   | $I_{CCL}$                           | $V_{FB} = 0\text{ V}$  | 34.5                          | 45            | 60                            | $\mu\text{A}$         | 1            |
| Timer latch reset voltage                     | $V_{RTL1}$                          | Within short-circuit protection delay time   | 0.7                           | 1.0           | 1.3                           | V                     | 1            |
|   | $V_{RTL2}$                          | After short-circuit protection circuit operated  | $V_{UVLO}$<br>$\times 0.95$   | $V_{UVLO}$    | $V_{UVLO}$<br>$\times 1.05$   | V                     | 1            |

\*1. The recommended range of the resistance ( $R_{osc}$ ) for oscillation frequency is  $R_{osc} = 120\text{ k}\Omega$  to  $470\text{ k}\Omega$  ( $f_{osc} = 280\text{ kHz}$  to  $1.08\text{ MHz}$ ). This range of oscillation frequency is the typical value when an ideal resistor is connected externally. In actual use, it is necessary to take account the dispersion of an IC ( $\pm 10\%$ ) into this value.

\*2. Set max. duty; Between 47 and 88.5 % ( $R_{Duty}/R_{OSC} = 0.5$  to  $3.2$ ); the oscillation frequency is 500 kHz or more  
Between 47 and 80 % ( $R_{Duty}/R_{OSC} = 1.0$  to  $3.2$ ); the oscillation frequency is less than 500 kHz

This range of max. duty is the typical value when an ideal resistor is connected externally. In actual use, it is necessary to take account the dispersion of an IC ( $\pm 5\%$ ) into this value.

\*3. The short-circuit protection time can be set by the external capacitor. Although the maximum set value by the external capacitor is unlimited under the ideal condition, set  $C_{SP} = \text{approx. } 0.47\text{ }\mu\text{F}$  as a target maximum value due to discharge time of the capacitor.

■ External Parts When Measuring Electrical Characteristics

Table 5 External Parts

| Element Name  | Symbol | Manufacturer             | Part Number                               |
|---|--------|--------------------------|---|
| Inductor  | L      | TDK Corporation          | LDR655312T 10 $\mu$ H                     |
| Diode   | SD     | Rohm Co., Ltd.           | RB491D                                    |
| Output capacitor                                      | CL     | —                        | Ceramic 10 $\mu$ F                        |
| Transistor  | M1     | Sanyo Electric Co., Ltd. | MCH3406                                   |
| Oscillation frequency setting resistor                | ROSC   | —                        | 200 k $\Omega$ (when $f_{OSC} = 650$ kHz) |
| Maximum duty ratio setting resistor                   | RDuty  | —                        | 300 k $\Omega$ (when MaxDuty = 73%)       |
| Short-circuit protection delay time setting capacitor | CSP    | —                        | 0.1 $\mu$ F (when $t_{PRO} = 50$ ms)      |
| Output voltage setting resistor 1                     | RFB1   | —                        | 8.2 k $\Omega$ (when $V_{OUT} = 9.2$ V)   |
| Output voltage setting resistor 2                     | RFB2   | —                        | 1.0 k $\Omega$ (when $V_{OUT} = 9.2$ V)   |
| FB pin capacitor                                      | CFB    | —                        | 180 pF                                    |
| Phase compensation resistor                           | RZ     | —                        | 200 k $\Omega$                            |
| Phase compensation capacitor                          | CZ     | —                        | 0.01 $\mu$ F                              |



■ Measurement Circuits



Figure 5



Figure 6

■ **Operation**

**1. Switching control method**

**1.1 PWM control**

The S-8333 Series is a DC-DC converter using a pulse width modulation method (PWM).

The pulse width of the S-8333 Series varies from 0% to the maximum duty set by RDuty depending on the load current, but its switching frequency does not change. Consequently, the ripple voltage generated from switching can be removed easily via a filter.

**2. Soft-start function**

For this IC, the built-in soft-start circuit controls the rush current and overshoot of the output voltage when powering on. Reference voltage adjustment and maximum duty control methods are adopted as the soft-start methods. The following describes the soft-start function at power application.

In the circuit where the input voltage is not directly output at shutdown by inserting a switch (SW) between the diode (SD) and  $V_{OUT}$  output, the  $V_{OUT}$  voltage when the  $V_{IN}$  voltage is applied with the SW OFF stays 0 V. Therefore, the voltage of the FB pin stays 0 V and the EXT output is in the step up status between the “H” and “L” levels due to the maximum duty. The maximum duty at this time is approximately 7% and the rush current at power application is controlled. The maximum duty soft start is accomplished by gradually increasing the duty width up to the maximum duty set by the external resistor RDuty (refer to **Figure 8**).

The reference voltage of the error amplifier input also gradually increases from 0 V at the same time as the maximum duty soft start. The increasing of the output voltage is controlled by turning the SW ON. The soft-start function is realized by controlling the voltage of the FB pin so that it is the same potential as the reference voltage that is slowly raised. A Rail-to-Rail amplifier is adopted as the error amplifier, which means that the voltage is loop controlled so that it can be the same as the reference voltage.

Once the reference voltage rises, the voltage cannot be reset (the reference voltage is 0 V) unless making the power supply voltage lower than the UVLO detection voltage. Conversely, when the power supply voltage rises up to the reset voltage after it is lowered to the UVLO detection voltage or lower, the output voltage is stepped up by the soft-start function.



**Figure 7**



Figure 8

### 3. Timer latch short-circuit protection function

This IC has a timer latch short-circuit protection circuit that stops the switching operation when the output voltage drops for a specific time due to output short-circuiting. A capacitor (CSP) that is used to set the delay time of this short-circuit protection circuit can be connected to the CSP pin.

This IC operates at the maximum duty ratio if the output voltage drops due to output short-circuiting. At the maximum duty ratio, constant-current charging of CSP starts. If this status lasts for a short-circuit protection delay time and the CSP pin voltage rises above the reference voltage, the latch mode is set. Note that the latch mode is different from the shutdown status in that the switching operation is stopped but the internal circuitry operates normally.

To reset the latch operation to protect the IC from short-circuiting, lower  $V_{IN}$  than the UVLO detection voltage. The latch mode within the short-circuit protection delay time is reset by decreasing  $V_{IN}$  to 1.0 V (Typ.) or lower. Note that the mode is not reset even if the  $V_{IN}$  is lowered to the UVLO detection voltage (refer to **Figure 9**).



Figure 9

### 4. UVLO function

This IC includes a UVLO (under-voltage lockout) circuit to prevent the IC from malfunctioning due to a transient status when power is applied or a momentary drop of the power supply voltage. When UVLO is in the detection state, switching is stopped and the external FET is held in the off status. Once UVLO enters the detection state, the soft-start function is reset.

Note that the other internal circuits operate normally and that the status is different from the power-off status.

**5. Error amplifier**

The error amplifier outputs the PWM control signal so that the voltage of the FB pin is held at a specific value (1 V). By connecting a resistor (RZ) and capacitor (CZ) to the output pin (CC pin) of the error amplifier in series, an optional loop gain can be set, enabling stabilized phase compensation.

**6. Operation**

The following are basic equations [(1) through (7)] of the step-up switching regulator (refer to **Figure 10**).



**Figure 10 Step-up Switching Regulator Circuit for Basic Equations**

Voltage at the CONT pin at the moment M1 is turned ON (current  $I_L$  flowing through L is zero),  $V_A$ :

$$V_A = V_S^{*1} \dots\dots\dots(1)$$

\*1.  $V_S$ : Non-saturated voltage of M1

Change in  $I_L$  over time:

$$\frac{dI_L}{dt} = \frac{V_L}{L} = \frac{V_{IN} - V_S}{L} \dots\dots\dots(2)$$

Integration of the above equation:

$$I_L = \left( \frac{V_{IN} - V_S}{L} \right) \times t \dots\dots\dots(3)$$

$I_L$  flows while M1 is ON ( $t_{ON}$ ). This time is determined by the oscillation frequency of OSC.

Peak current ( $I_{PK}$ ) after  $t_{ON}$ :

$$I_{PK} = \left( \frac{V_{IN} - V_S}{L} \right) \times t_{ON} \dots\dots\dots(4)$$

The energy stored in L is represented by  $\frac{1}{2} \times L (I_{PK})^2$ .

When M1 is turned OFF ( $t_{OFF}$ ), the energy stored in L is released via a diode, generating a reverse voltage ( $V_L$ ).  
 $V_L$ :

$$V_L = (V_{OUT} + V_D^{*2}) - V_{IN} \dots\dots\dots(5)$$

\*2.  $V_D$ : Diode forward voltage

The voltage on the CONT pin rises only by  $V_{OUT} + V_D$ .

Change in current ( $I_L$ ) flowing through the diode into  $V_{OUT}$  during  $t_{OFF}$ :

$$\frac{dI_L}{dt} = \frac{V_L}{L} = \frac{V_{OUT} + V_D - V_{IN}}{L} \dots\dots\dots (6)$$

Integration of the above equation is as follows:

$$I_L = I_{PK} - \left( \frac{V_{OUT} + V_D - V_{IN}}{L} \right) \times t \dots\dots\dots (7)$$

During  $t_{ON}$ , energy is stored in  $L$  and is not transmitted to  $V_{OUT}$ . When receiving output current ( $I_{OUT}$ ) from  $V_{OUT}$ , the energy of the capacitor ( $C_L$ ) is used. As a result, the pin voltage of  $C_L$  is reduced, and goes to the lowest level after  $M1$  is turned ON ( $t_{ON}$ ). When  $M1$  is turned OFF, the energy stored in  $L$  is transmitted via the diode to  $C_L$ , and the pin voltage of  $C_L$  rises drastically. Because  $V_{OUT}$  is a time function indicating the maximum value (ripple voltage:  $V_{p-p}$ ) when the current flowing through the diode into  $V_{OUT}$  and the load current  $I_{OUT}$  match.

Next, this ripple voltage is determined as follows.

$I_{OUT}$  vs  $t_1$  (time) from after  $t_{ON}$ , when  $V_{OUT}$  reaches the maximum level:

$$I_{OUT} = I_{PK} - \left( \frac{V_{OUT} + V_D - V_{IN}}{L} \right) \times t_1 \dots\dots\dots (8)$$

$$\therefore t_1 = (I_{PK} - I_{OUT}) \times \left( \frac{L}{V_{OUT} + V_D - V_{IN}} \right) \dots\dots\dots (9)$$

When  $t_{OFF}$ ,  $I_L = 0$  (when the energy of the inductor is completely transmitted):

Based on equation (7),

$$\left( \frac{L}{V_{OUT} + V_D - V_{IN}} \right) = \frac{t_{OFF}}{I_{PK}} \dots\dots\dots (10)$$

When substituting equation (10) for equation (9):

$$t_1 = t_{OFF} - \left( \frac{I_{OUT}}{I_{PK}} \right) \times t_{OFF} \dots\dots\dots (11)$$

Electrical charge  $\Delta Q_1$  which is charged in  $C_L$  during  $t_1$ :

$$\Delta Q_1 = \int_0^{t_1} I_L dt = I_{PK} \times \int_0^{t_1} dt - \frac{V_{OUT} + V_D - V_{IN}}{L} \times \int_0^{t_1} t dt = I_{PK} \times t_1 - \frac{V_{OUT} + V_D - V_{IN}}{L} \times \frac{1}{2} t_1^2 \dots\dots\dots (12)$$

When substituting equation (12) for equation (9):

$$\Delta Q_1 = I_{PK} - \frac{1}{2} (I_{PK} - I_{OUT}) \times t_1 = \frac{I_{PK} + I_{OUT}}{2} \times t_1 \dots\dots\dots (13)$$

A rise voltage ( $V_{p-p}$ ) due to  $\Delta Q_1$ :

$$V_{p-p} = \frac{\Delta Q_1}{C_L} = \frac{1}{C_L} \times \left( \frac{I_{PK} + I_{OUT}}{2} \right) \times t_1 \dots\dots\dots (14)$$

When taking into consideration  $I_{OUT}$  consumed during  $t_1$  and  $ESR^{*1}$  ( $R_{ESR}$ ) of  $C_L$ :

$$V_{p-p} = \frac{\Delta Q_1}{C_L} = \frac{1}{C_L} \times \left( \frac{I_{PK} + I_{OUT}}{2} \right) \times t_1 + \left( \frac{I_{PK} + I_{OUT}}{2} \right) \times R_{ESR} - \frac{I_{OUT} \times t_1}{C_L} \dots\dots\dots (15)$$

**\*1. Equivalent Series Resistance**

When substituting equation (11) for equation (15):

$$V_{p-p} = \frac{(I_{PK} - I_{OUT})^2}{2 I_{PK}} \times \frac{t_{OFF}}{C_L} + \left( \frac{I_{PK} + I_{OUT}}{2} \right) \times R_{ESR} \dots\dots\dots (16)$$

Therefore to reduce the ripple voltage, it is important that the capacitor connected to the output pin has a large capacity and a small ESR.

## External Parts Selection

### 1. Inductor

The inductance has a strong influence on the maximum output current ( $I_{OUT}$ ) and efficiency ( $\eta$ ).

The peak current ( $I_{PK}$ ) increases by decreasing L and the stability of the circuit improves and  $I_{OUT}$  increases. If L is decreased further, the efficiency falls, and  $I_{OUT}$  decreases if the current drive capability of the external transistor is insufficient.

The loss of  $I_{PK}$  by the switching transistor decreases by increasing L and the efficiency becomes maximum at a certain L value. Further increasing L decrease the efficiency due to the loss of the DC resistance of the inductor.  $I_{OUT}$  also decreases.

If the oscillation frequency is higher, a smaller L value can be chosen, making the inductor smaller. In the S-8333 Series, the oscillation frequency can be varied within the range of 280 kHz to 1.08 MHz by the external resistor, so select an L value best suited to the frequency. The recommended value is between 2.2  $\mu$ H and 22  $\mu$ H.

When selecting an inductor, note the allowable current of the inductor. If a current exceeding this allowable current flows through the inductor, magnetic saturation occurs, substantially lowering the efficiency and increasing the current, which results in damage to the IC.

Therefore, select an inductor so that  $I_{PK}$  does not exceed the allowable current.  $I_{PK}$  is expressed by the following equations in the discontinuous mode and continuous mode.

$$I_{PK} = \sqrt{\frac{2 I_{OUT}(V_{OUT} + V_D - V_{IN})}{f_{osc} \times L}} \quad (\text{discontinuous mode}) \dots\dots\dots (17)$$

$$I_{PK} = \frac{V_{OUT} + V_D}{V_{IN}} \times I_{OUT} + \frac{(V_{OUT} + V_D - V_{IN}) \times V_{IN}}{2 \times (V_{OUT} + V_D) \times f_{osc} \times L} \quad (\text{continuous mode}) \dots\dots\dots (18)$$

$f_{osc}$  = Oscillation frequency,  $V_D \cong 0.4$  V.

### 2. Diode

Use an external diode that meets the following requirements.

- Low forward voltage
- High switching speed
- Reverse breakdown voltage:  $V_{OUT} + [\text{Spike voltage}]$  or more
- Rated current:  $I_{PK}$  or more

### 3. Capacitors ( $C_{IN}$ , $C_L$ )

The capacitor on the input side ( $C_{IN}$ ) can lower the supply impedance and level the input current for better efficiency. Select  $C_{IN}$  according to the impedance of the power supply to be used.

The capacitor on the output side ( $C_L$ ) is used to smooth the output voltage. Select an appropriate capacitance value based on the I/O conditions and load conditions. A capacitance of 10  $\mu$ F or more is recommended.

By adjusting the phase compensation of the feedback loop using the external resistor (RZ) and capacitor (CZ), a ceramic capacitor can be used as the capacitor on the output side. If a capacitor whose equivalent series resistance is between 30 m $\Omega$  and 500 m $\Omega$  is used as the output capacitor, the adjustable range of the phase compensation is wider; however, note that other characteristics may be affected by ripple voltage or other conditions at this time. The optimal capacitor differs depending on the L value, capacitance value, wiring, and application (output load), so select the capacitor after performing sufficient evaluation under the actual usage conditions.

#### 4. External transistor

A bipolar (NPN) or enhancement (N-channel) MOS FET transistor can be used as the external capacitor.

##### 4.1 Bipolar (NPN) type

The driving capability when the output current is increased by using a bipolar transistor is determined by  $h_{FE}$  and  $R_b$  of the bipolar transistor. **Figure 11** shows a peripheral circuit.



**Figure 11 External Transistor Periphery**

1 kΩ is recommended for  $R_b$ . Actually, calculate the necessary base current ( $I_b$ ) from  $h_{FE}$  of the bipolar transistor as follows and select an  $R_b$  value lower than this.

$$I_b = \frac{I_{PK}}{h_{FE}}$$

$$R_b = \frac{V_{IN} - 0.7}{I_b} - \frac{0.4}{|I_{EXTH}|}$$

A small  $R_b$  increases the output current, but the efficiency decreases. Actually, a pulsating current flows and a voltage drop occurs due to the wiring capacitance. Determine the optimum value by experiment.

A speed-up capacitor ( $C_b$ ) connected in parallel with  $R_b$  resistance as shown in **Figure 11** decreases the switching loss and improves the efficiency.

Select  $C_b$  by observing the following equation.

$$C_b \leq \frac{1}{2 \pi \times R_b \times f_{osc} \times 0.7}$$

However, in practice, the optimum  $C_b$  value also varies depending on the characteristics of the bipolar transistor employed. Therefore, determine the optimum value of  $C_b$  by experiment.

##### 4.2 Enhancement MOS FET type

Use an Nch power MOS FET. For high efficiency, using a MOS FET with a low ON resistance ( $R_{ON}$ ) and small input capacitance ( $C_{ISS}$ ) is ideal, however, ON resistance and input capacitance generally share a trade-off relationship. The ON resistance is efficient in a range in which the output current is relatively great during low-frequency switching, and the input capacitance is efficient in a range in which the output current is middling during high-frequency switching. Select a MOS FET whose ON resistance and input capacitance are optimal depending on the usage conditions.

The input voltage ( $V_{IN}$ ) is supplied for the gate voltage of the MOS FET, so select a MOS FET with a gate withstanding voltage that is equal to the maximum usage value of the input voltage or higher and a drain withstanding voltage that is equal to the amount of the output voltage ( $V_{OUT}$ ) and diode voltage ( $V_D$ ) or higher.

If a MOS FET with a threshold that is near the UVLO detection voltage is used, a large current may flow, stopping the output voltage from rising and possibly generating heat in the worst case. Select a MOS FET with a threshold that is sufficiently lower than the UVLO detection voltage value.



**5. Oscillation frequency and maximum duty ratio setting resistors (ROSC, RDuty)**

With the S-8333 Series, the oscillation frequency can be set in a range of 280 kHz to 1.08 MHz using external resistance. Connect a resistor across the ROSC and VSS pins. Select the resistor by using the following equation and referring to **Figure 12**. However, the following equation and figure assume that the resistance value is the desired value and show the theoretical values when the IC is in the typical conditions. Note that fluctuations of resistance and IC are not considered.

$$R_{OSC} [k\Omega] \cong \frac{130 \times 10^3}{f_{OSC} [kHz]}$$

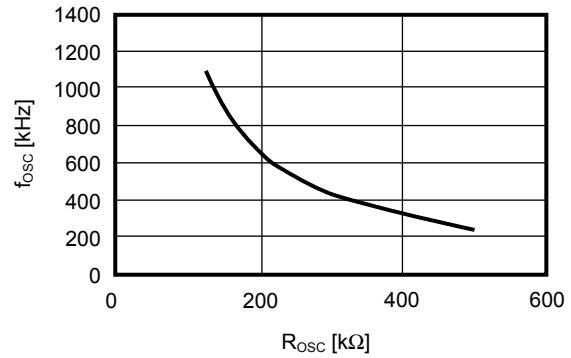

**Figure 12** ROSC vs. fosc

With the S-8333 Series, the maximum duty ratio can be set in a range of 47% to 88.5% (between 47 to 80%, if the oscillation frequency is less than 500 kHz) by an external resistor. Connect the resistor across the RDuty and VSS pins. Select the resistance by using the following equation and referring to **Figure 13**. The maximum duty ratio fluctuates according to the oscillation frequency. If the value of ROSC is changed, therefore, be sure to change the value of RDuty so that it is always in proportion to RDuty / ROSC. However, the following equation and figure assume that the resistance value is the desired value and show the theoretical values when the IC is in the typical conditions. Note that fluctuations of resistance and IC are not considered.

**Caution** Set max. duty 80% or less if the oscillation frequency is less than 500 kHz.

$$\frac{R_{Duty}}{R_{OSC}} \cong \frac{(95.5 - \text{MaxDuty})}{15.0}$$



**Figure 13** RDuty / ROSC vs. MaxDuty

Connect resistors ROSC and RDuty as close to the IC as possible.

**6. Short-circuit protection delay time setting capacitor (CSP)**

With the S-8333 Series, the short-circuit protection delay time can be set to any value by an external capacitor. Connect the capacitor across the CSP and VSS pins. Select the capacitance by using the following equation and referring to **Figure 14**. However, the following equation and figure assume that the capacitor value is the desired value and show the theoretical values when the IC is in the typical conditions. Note that fluctuations of capacitor and IC are not considered.

$$C_{SP} [\mu F] \cong \frac{t_{PRO} [ms] \times 2 \times 10^{-3}}{1.0}$$

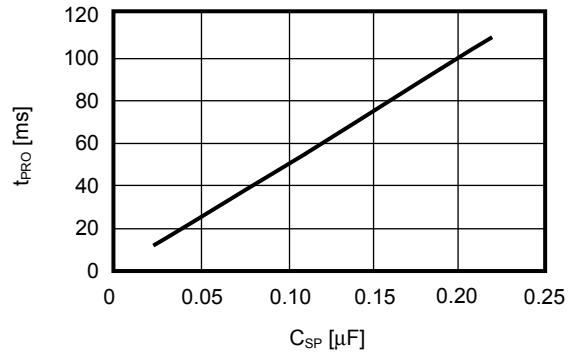

**Figure 14 C<sub>SP</sub> vs. t<sub>PRO</sub>**

**7. Output voltage setting resistors (RFB1, RFB2)**

With the S-8333 Series, the output voltage can be set to any value by external divider resistors. Connect the divider resistors across the V<sub>OUT</sub> and VSS pins. Because V<sub>FB</sub> = 1 V, the output voltage can be calculated by this equation.

$$V_{OUT} = \frac{(R_{FB1} + R_{FB2})}{R_{FB2}}$$

Connect divider resistors RFB1 and RFB2 as close to the IC to minimize effects from of noise. If noise does have an effect, adjust the values of RFB1 and RFB2 so that R<sub>FB1</sub> + R<sub>FB2</sub> < 100 kΩ.

CFB connected in parallel with RFB1 is a capacitor for phase compensation. Select the optimum value of this capacitor at which the stable operation can be ensured from the values of the inductor and output capacitor.

**8. Phase compensation setting resistor and capacitor (RZ, CZ)**

The S-8333 Series needs appropriate compensation for the voltage feedback loop to prevent excessive output ripple and unstable operation from deteriorating the efficiency. This compensation is implemented by connecting RZ and CZ in series across the CC and VSS pins. RZ sets the high-frequency gain for a high-speed transient response. CZ sets the pole and zero of the error amplifier and keeps the loop stable. Adjust RZ and CZ, taking into consideration conditions such as the inductor, output capacitor, and load current, so that the optimum transient characteristics can be obtained.

■ Standard Circuit

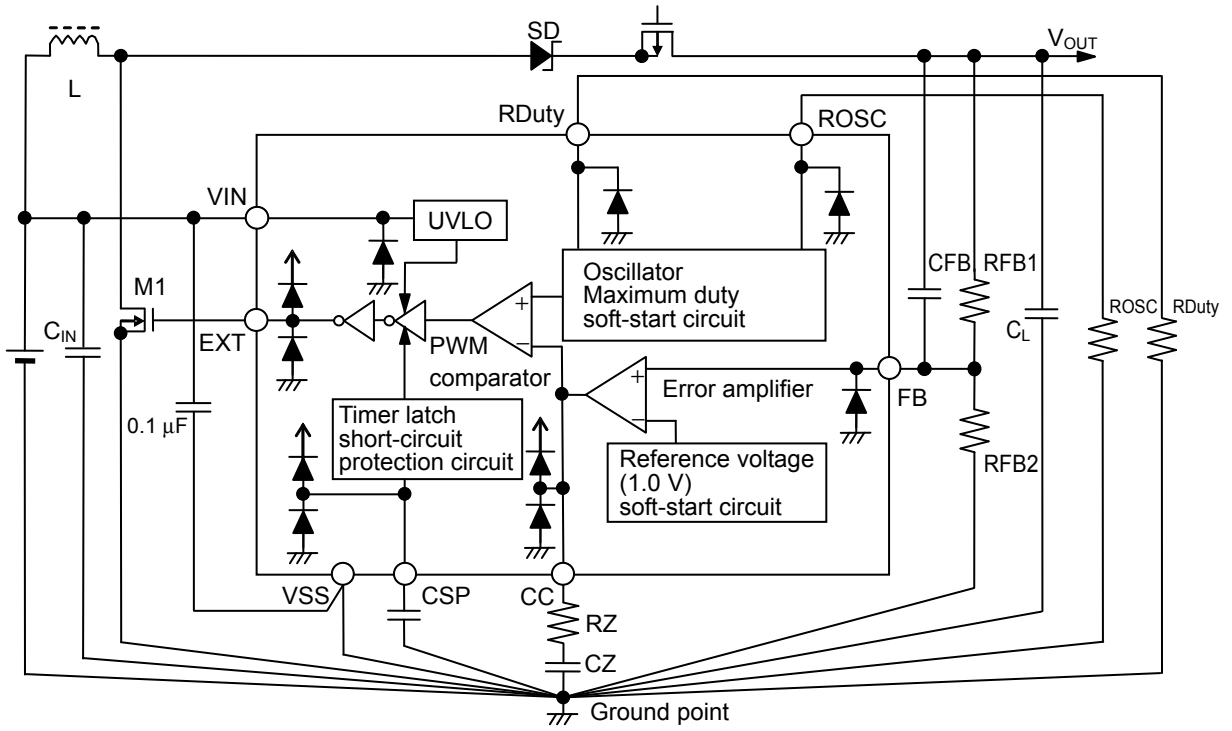

Figure 15 Standard Circuit

**Caution** The above connection diagram and constant will not guarantee successful operation. Perform thorough evaluation using the actual application to set the constant.

## ■ Precaution

- Mount external capacitors, diodes, and inductor as close as possible to the IC.
- Characteristics ripple voltage and spike noise occur in IC containing switching regulators. Moreover rush current flows at the time of a power supply injection. Because these largely depend on the inductor, the capacitor and impedance of power supply used, fully check them using an actually mounted model.
- Make sure the dissipation of the switching transistor (especially at a high temperature) does not exceed the allowable power dissipation of the package.
- The performance of a switching regulator varies depending on the design of the PCB patterns, peripheral circuits, and external parts. Thoroughly test all settings with your device.
- The capacitor, diode, inductor and others used as external parts do not assure the operation at high temperature. Evaluate fully using the actual application when designing.
- This IC builds in soft start function, starts reference voltage gradually, and it is controlled so that FB pin voltage and reference voltage become this potential. Therefore, keep in mind that it will be in a maximum duty state according to the factor of IC exterior if FB pin voltage is held less than reference voltage.
- Although the IC contains a static electricity protection circuit, static electricity or voltage that exceeds the limit of the protection circuit should not be applied.
- SII Semiconductor Corporation assumes no responsibility for the way in which this IC is used on products created using this IC or for the specifications of that product, nor does SII Semiconductor Corporation assume any responsibility for any infringement of patents or copyrights by products that include this IC either in Japan or in other countries.

■ Characteristics (Typical Data)

1. Example of Major Temperature Characteristics (Ta = -40 to +85°C)

I<sub>SS1</sub> vs. Ta (V<sub>IN</sub> = 3.3 V)

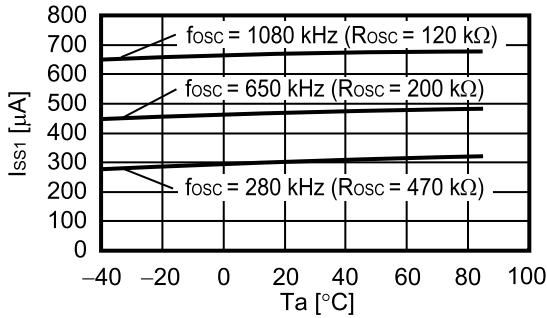

I<sub>EXTH</sub> vs. Ta (V<sub>IN</sub> = 3.3 V)

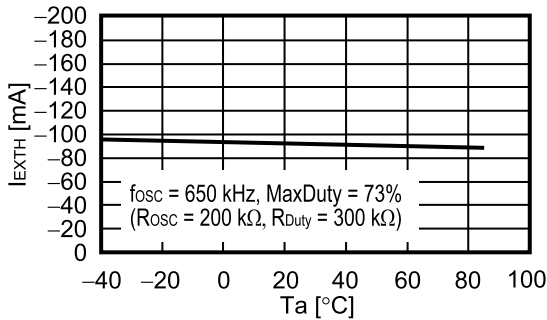

I<sub>EXTL</sub> vs. Ta (V<sub>IN</sub> = 3.3 V)

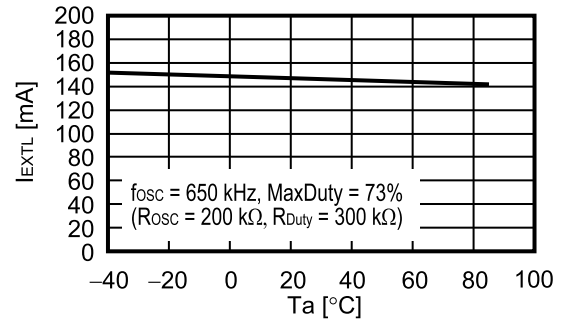

I<sub>FB</sub> vs. Ta (V<sub>IN</sub> = 3.3 V)

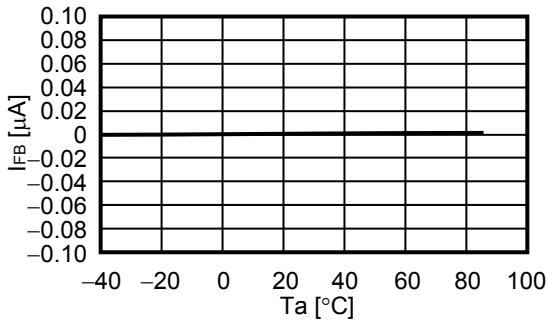

f<sub>osc</sub> vs. Ta (V<sub>IN</sub> = 3.3 V)

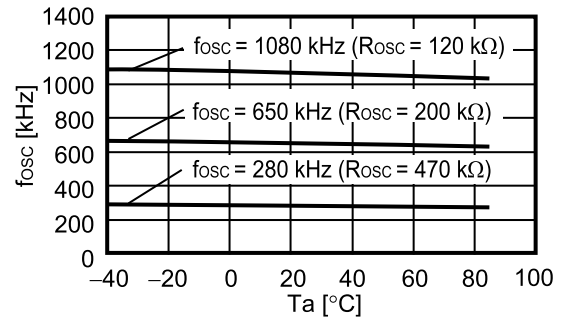

MaxDuty vs. Ta (V<sub>IN</sub> = 3.3 V)

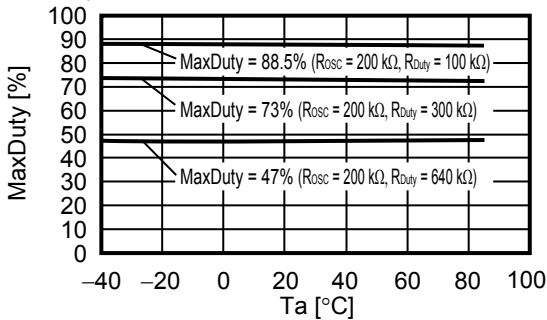

t<sub>SS</sub> vs. Ta (V<sub>IN</sub> = 3.3 V)

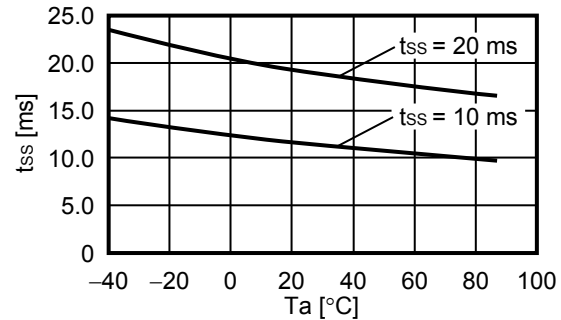

$t_{PRO}$  vs.  $T_a$  ( $V_{IN} = 3.3\text{ V}$ )



$V_{UVLO}$  vs.  $T_a$

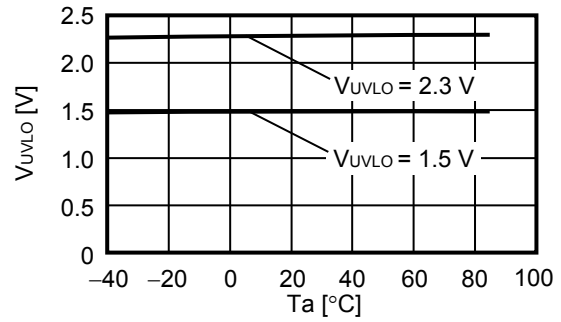

$V_{UVLOHYS}$  vs.  $T_a$



$I_{CCH}$  vs.  $T_a$  ( $V_{IN} = 3.3\text{ V}$ )

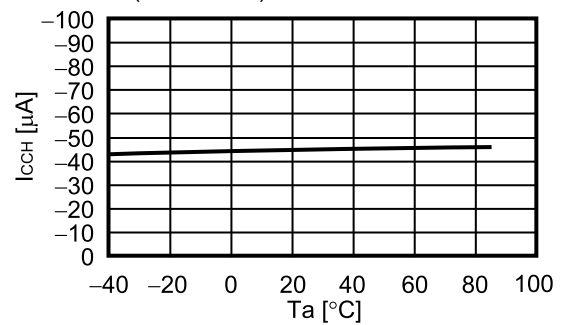

$I_{CCL}$  vs.  $T_a$  ( $V_{IN} = 3.3\text{ V}$ )

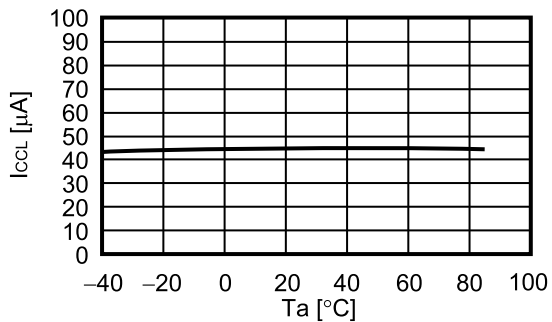

$V_{RILT1}$  vs.  $T_a$  ( $V_{IN} = 3.3\text{ V}$ )

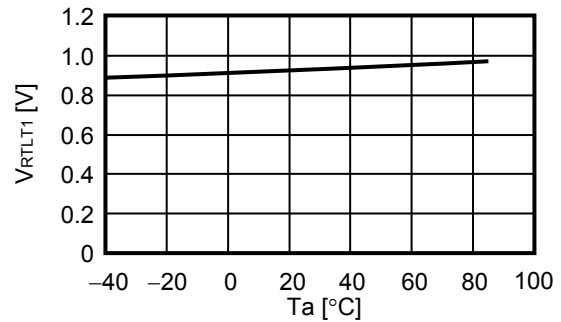

**2. Example of Major Power Supply Dependence Characteristics (Ta = 25°C)**

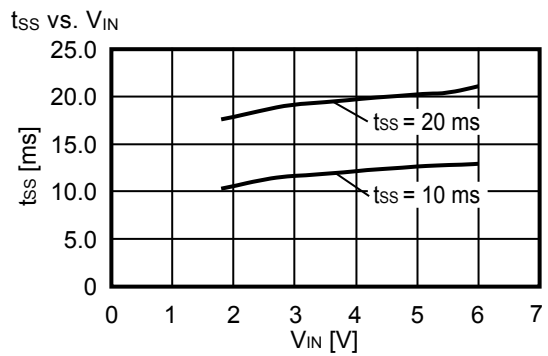
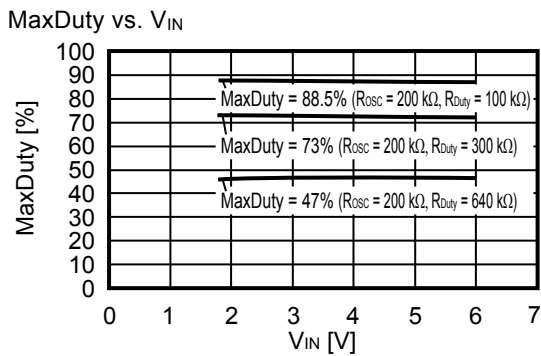
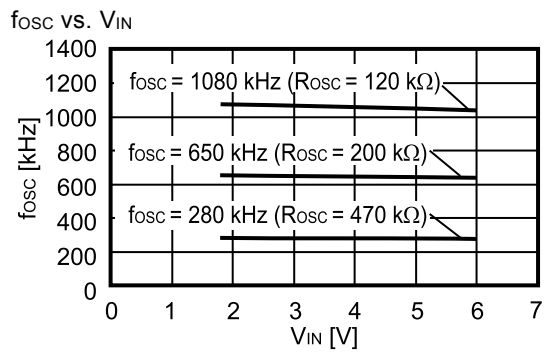
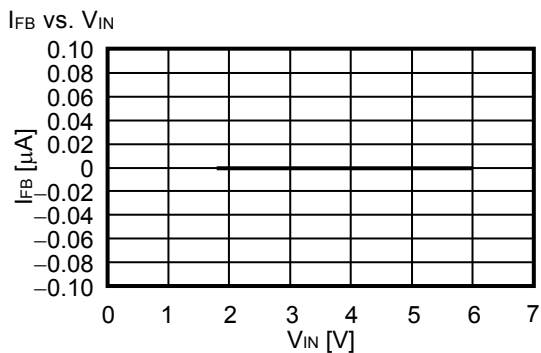
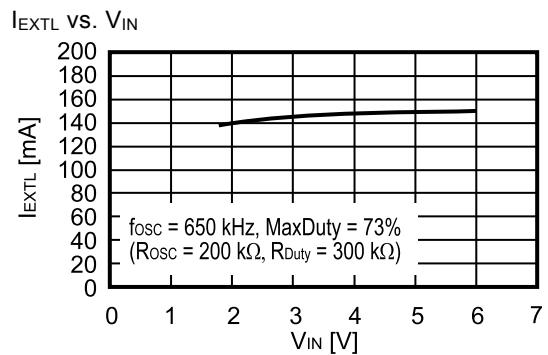
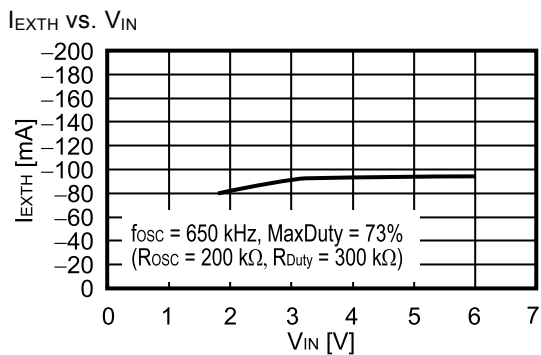
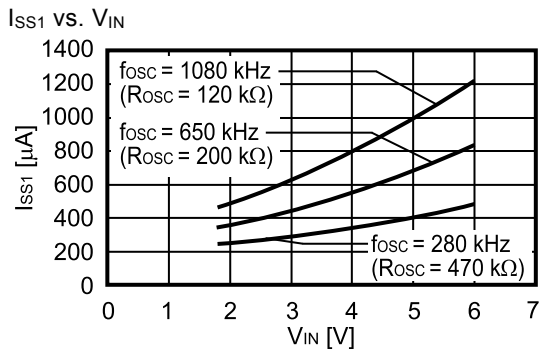





### 3. Example of External Parts Dependence Characteristics

fosc vs. R<sub>osc</sub> (V<sub>IN</sub> = 3.3 V)



MaxDuty vs. R<sub>Duty</sub> / R<sub>osc</sub> (R<sub>osc</sub> = 200 kΩ, V<sub>IN</sub> = 3.3 V)



t<sub>PRO</sub> vs. CSP (V<sub>IN</sub> = 3.3 V)



#### 4. Examples of Transient Response Characteristics

##### 4.1 Powering ON ( $V_{OUT} = 9.2\text{ V}$ , $V_{IN} = 0\text{ V} \rightarrow 3.3\text{ V}$ , $T_a = 25^\circ\text{C}$ )

**Remark** The switch (SW) is inserted between the diode (SD) and VOUT output.  
 Controlled externally to turn SW on a few ms later after the VIN voltage is applied.

(1)  $f_{osc} = 1080\text{ kHz}$ ,  $I_{OUT} = 0\text{ mA}$ ,  $t_{SS} = 10\text{ ms}$



(2)  $f_{osc} = 1080\text{ kHz}$ ,  $I_{OUT} = 100\text{ mA}$ ,  $t_{SS} = 10\text{ ms}$



(3)  $f_{osc} = 650\text{ kHz}$ ,  $I_{OUT} = 0\text{ mA}$ ,  $t_{SS} = 10\text{ ms}$



(4)  $f_{osc} = 650\text{ kHz}$ ,  $I_{OUT} = 100\text{ mA}$ ,  $t_{SS} = 10\text{ ms}$



(5)  $f_{osc} = 280\text{ kHz}$ ,  $I_{OUT} = 0\text{ mA}$ ,  $t_{SS} = 10\text{ ms}$



(6)  $f_{osc} = 280\text{ kHz}$ ,  $I_{OUT} = 100\text{ mA}$ ,  $t_{SS} = 10\text{ ms}$



4.2 Load fluctuations ( $V_{OUT} = 9.2\text{ V}$ ,  $V_{IN} = 3.3\text{ V}$ ,  $T_a = 25^\circ\text{C}$ ,  $R_z = 200\text{ k}\Omega$ ,  $C_z = 0.01\text{ }\mu\text{F}$ )

(1)  $f_{osc} = 1080\text{ kHz}$ ,  $I_{OUT} = 0.1\text{ mA} \rightarrow 100\text{ mA}$



(2)  $f_{osc} = 1080\text{ kHz}$ ,  $I_{OUT} = 100\text{ mA} \rightarrow 0.1\text{ mA}$



(3)  $f_{osc} = 650\text{ kHz}$ ,  $I_{OUT} = 0.1\text{ mA} \rightarrow 100\text{ mA}$



(4)  $f_{osc} = 650\text{ kHz}$ ,  $I_{OUT} = 100\text{ mA} \rightarrow 0.1\text{ mA}$



(5)  $f_{osc} = 280\text{ kHz}$ ,  $I_{OUT} = 0.1\text{ mA} \rightarrow 100\text{ mA}$



(6)  $f_{osc} = 280\text{ kHz}$ ,  $I_{OUT} = 100\text{ mA} \rightarrow 0.1\text{ mA}$



**4.3 Input voltage fluctuations ( $V_{OUT} = 9.2\text{ V}$ ,  $I_{OUT} = 100\text{ mA}$ ,  $R_Z = 200\text{ k}\Omega$ ,  $C_Z = 0.01\text{ }\mu\text{F}$ )**

**(1)  $f_{osc} = 1080\text{ kHz}$ ,  $V_{IN} = 2.8\text{ V} \rightarrow 3.8\text{ V}$**



**(2)  $f_{osc} = 1080\text{ kHz}$ ,  $V_{IN} = 3.8\text{ V} \rightarrow 2.8\text{ V}$**



**(3)  $f_{osc} = 650\text{ kHz}$ ,  $V_{IN} = 2.8\text{ V} \rightarrow 3.8\text{ V}$**

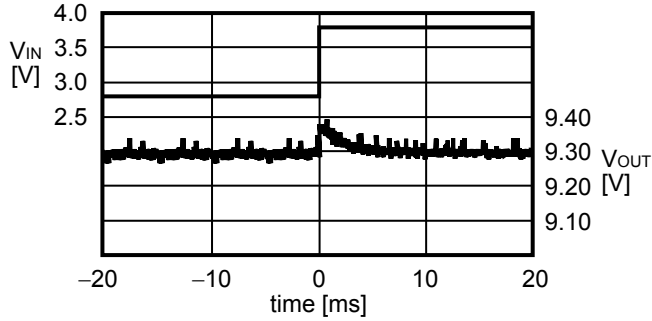

**(4)  $f_{osc} = 650\text{ kHz}$ ,  $V_{IN} = 3.8\text{ V} \rightarrow 2.8\text{ V}$**

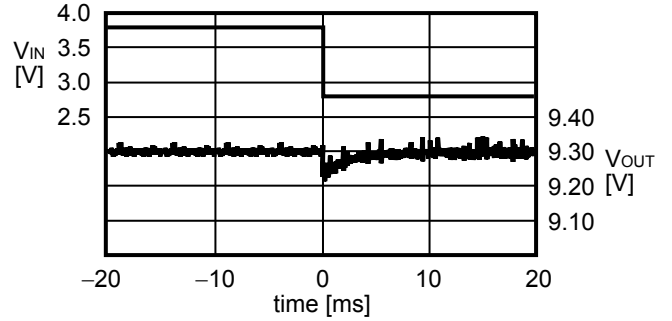

**(5)  $f_{osc} = 280\text{ kHz}$ ,  $V_{IN} = 2.8\text{ V} \rightarrow 3.8\text{ V}$**



**(6)  $f_{osc} = 280\text{ kHz}$ ,  $V_{IN} = 3.8\text{ V} \rightarrow 2.8\text{ V}$**



■ Reference Data

1. Reference data for external parts

Table 6 Properties of External Parts

| Element Name               | Product Name | Manufacture              | Characteristics  |
|----------------------------|--------------|--------------------------|--|
| Inductor                   | LDR655312T   | TDK Corporation          | 10 $\mu$ H, DCR <sup>*1</sup> = 307 m $\Omega$ , I <sub>MAX</sub> <sup>*2</sup> = 0.7 A, Height = 1.2 mm   |
| Diode                      | RB491D       | Rohm Co., Ltd.           | V <sub>F</sub> <sup>*3</sup> = 0.45 V, I <sub>F</sub> <sup>*4</sup> = 1.0 A  |
| Output capacitor (ceramic) | —            | —                        | 16 V, 10 $\mu$ F   |
| Transistor                 | MCH3406      | Sanyo Electric Co., Ltd. | V <sub>DSS</sub> <sup>*5</sup> = 20 V, V <sub>GSS</sub> <sup>*6</sup> = $\pm$ 10 V, C <sub>iss</sub> <sup>*7</sup> = 280 pF, R <sub>DS(ON)</sub> <sup>*8</sup> = 82 m $\Omega$ max. (V <sub>GS</sub> <sup>*9</sup> = 2.5 V, I <sub>D</sub> <sup>*10</sup> = 1 A) |

- \*1. DCR : DC resistance
- \*2. I<sub>MAX</sub> : Maximum allowable current
- \*3. V<sub>F</sub> : Forward voltage
- \*4. I<sub>F</sub> : Forward current
- \*5. V<sub>DSS</sub> : Drain to source voltage (when short circuited between the gate and source)
- \*6. V<sub>GSS</sub> : Gate to source voltage (when short circuited between the drain and source)
- \*7. C<sub>iss</sub> : Input capacitance
- \*8. R<sub>DS(ON)</sub> : Drain to source on resistance
- \*9. V<sub>GS</sub> : Gate to source voltage
- \*10. I<sub>D</sub> : Drain current

**Caution** The values shown in the characteristics column of Table 6 above are based on the materials provided by each manufacturer. However, consider the characteristics of the original materials when using the above products.

**2. Reference data (1)**

The data of (a) output current ( $I_{OUT}$ ) vs. efficiency ( $\eta$ ) characteristics and (b) output current ( $I_{OUT}$ ) vs. output voltage ( $V_{OUT}$ ) characteristics is shown below.

**2.1  $V_{OUT} = 13.1\text{ V}$  ( $R_{FB1} = 7.5\text{ k}\Omega$ ,  $R_{FB2} = 620\ \Omega$ )**

(1)  $f_{OSC} = 1080\text{ kHz}$ ,  $MaxDuty = 73\%$  ( $R_{OSC} = 120\text{ k}\Omega$ ,  $R_{Duty} = 180\text{ k}\Omega$ )

(a)  $I_{OUT}$  vs.  $\eta$



(b)  $I_{OUT}$  vs.  $V_{OUT}$



(2)  $f_{OSC} = 650\text{ kHz}$ ,  $MaxDuty = 73\%$  ( $R_{OSC} = 200\text{ k}\Omega$ ,  $R_{Duty} = 300\text{ k}\Omega$ )

(a)  $I_{OUT}$  vs.  $\eta$



(b)  $I_{OUT}$  vs.  $V_{OUT}$



(3)  $f_{OSC} = 280\text{ kHz}$ ,  $MaxDuty = 73\%$  ( $R_{OSC} = 470\text{ k}\Omega$ ,  $R_{Duty} = 750\text{ k}\Omega$ )

(a)  $I_{OUT}$  vs.  $\eta$

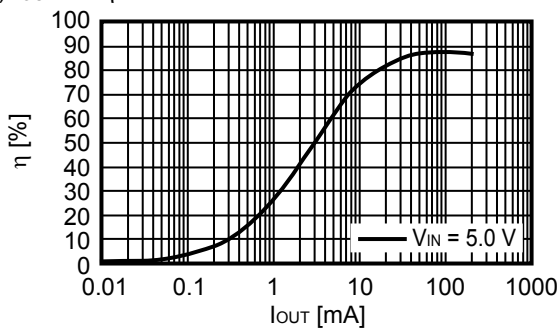

(b)  $I_{OUT}$  vs.  $V_{OUT}$

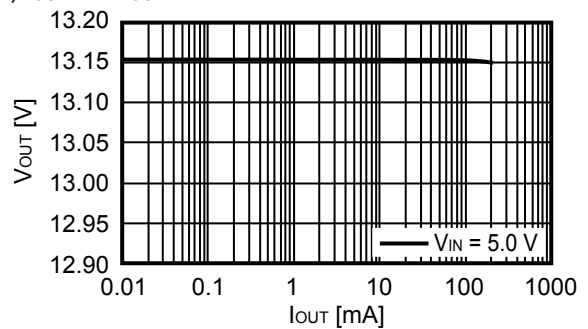

**2.2  $V_{OUT} = 9.2\text{ V}$  ( $R_{FB1} = 8.2\text{ k}\Omega$ ,  $R_{FB2} = 1.0\text{ k}\Omega$ )**

(1)  $f_{OSC} = 1080\text{ kHz}$ ,  $MaxDuty = 73\%$  ( $R_{OSC} = 120\text{ k}\Omega$ ,  $R_{Duty} = 180\text{ k}\Omega$ )

(a)  $I_{OUT}$  vs.  $\eta$



(b)  $I_{OUT}$  vs.  $V_{OUT}$



(2)  $f_{OSC} = 650\text{ kHz}$ ,  $MaxDuty = 73\%$  ( $R_{OSC} = 200\text{ k}\Omega$ ,  $R_{Duty} = 300\text{ k}\Omega$ )

(a)  $I_{OUT}$  vs.  $\eta$



(b)  $I_{OUT}$  vs.  $V_{OUT}$



(3)  $f_{OSC} = 280\text{ kHz}$ ,  $MaxDuty = 73\%$  ( $R_{OSC} = 470\text{ k}\Omega$ ,  $R_{Duty} = 750\text{ k}\Omega$ )

(a)  $I_{OUT}$  vs.  $\eta$



(b)  $I_{OUT}$  vs.  $V_{OUT}$



**2.3  $V_{OUT} = 6.1\text{ V}$  ( $R_{FB1} = 5.1\text{ k}\Omega$ ,  $R_{FB2} = 1.0\text{ k}\Omega$ )**

(1)  $f_{osc} = 1080\text{ kHz}$ ,  $MaxDuty = 73\%$  ( $R_{osc} = 120\text{ k}\Omega$ ,  $R_{Duty} = 180\text{ k}\Omega$ )

(a)  $I_{OUT}$  vs.  $\eta$



(b)  $I_{OUT}$  vs.  $V_{OUT}$



(2)  $f_{osc} = 650\text{ kHz}$ ,  $MaxDuty = 73\%$  ( $R_{osc} = 200\text{ k}\Omega$ ,  $R_{Duty} = 300\text{ k}\Omega$ )

(a)  $I_{OUT}$  vs.  $\eta$



(b)  $I_{OUT}$  vs.  $V_{OUT}$



(3)  $f_{osc} = 280\text{ kHz}$ ,  $MaxDuty = 73\%$  ( $R_{osc} = 470\text{ k}\Omega$ ,  $R_{Duty} = 750\text{ k}\Omega$ )

(a)  $I_{OUT}$  vs.  $\eta$



(b)  $I_{OUT}$  vs.  $V_{OUT}$





### 3. Reference data (2)

The data of output current ( $I_{OUT}$ ) vs. ripple voltage ( $V_r$ ) characteristics is shown below.

#### 3.1 $V_{OUT} = 13.1\text{ V}$ ( $R_{FB1} = 7.5\text{ k}\Omega$ , $R_{FB2} = 620\ \Omega$ )

(1)  $f_{OSC} = 1080\text{ kHz}$ , MaxDuty = 73%  
 ( $R_{OSC} = 120\text{ k}\Omega$ ,  $R_{Duty} = 180\text{ k}\Omega$ )



(2)  $f_{OSC} = 650\text{ kHz}$ , MaxDuty = 73%  
 ( $R_{OSC} = 200\text{ k}\Omega$ ,  $R_{Duty} = 300\text{ k}\Omega$ )



(3)  $f_{OSC} = 280\text{ kHz}$ , MaxDuty = 73%  
 ( $R_{OSC} = 470\text{ k}\Omega$ ,  $R_{Duty} = 750\text{ k}\Omega$ )

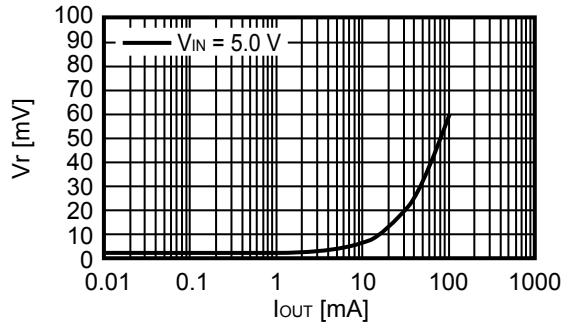

#### 3.2 $V_{OUT} = 9.2\text{ V}$ ( $R_{FB1} = 8.2\text{ k}\Omega$ , $R_{FB2} = 1.0\text{ k}\Omega$ )

(1)  $f_{OSC} = 1080\text{ kHz}$ , MaxDuty = 73%  
 ( $R_{OSC} = 120\text{ k}\Omega$ ,  $R_{Duty} = 180\text{ k}\Omega$ )



(2)  $f_{OSC} = 650\text{ kHz}$ , MaxDuty = 73%  
 ( $R_{OSC} = 200\text{ k}\Omega$ ,  $R_{Duty} = 300\text{ k}\Omega$ )



(3)  $f_{OSC} = 280\text{ kHz}$ , MaxDuty = 73%  
 ( $R_{OSC} = 470\text{ k}\Omega$ ,  $R_{Duty} = 750\text{ k}\Omega$ )

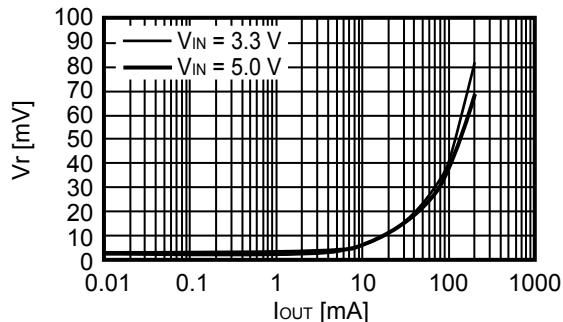

**3.3  $V_{OUT} = 6.1\text{ V}$  ( $R_{FB1} = 5.1\text{ k}\Omega$ ,  $R_{FB2} = 1.0\text{ k}\Omega$ )**

(1)  $f_{osc} = 1080\text{ kHz}$ , MaxDuty = 73%  
 ( $R_{OSC} = 120\text{ k}\Omega$ ,  $R_{Duty} = 180\text{ k}\Omega$ )

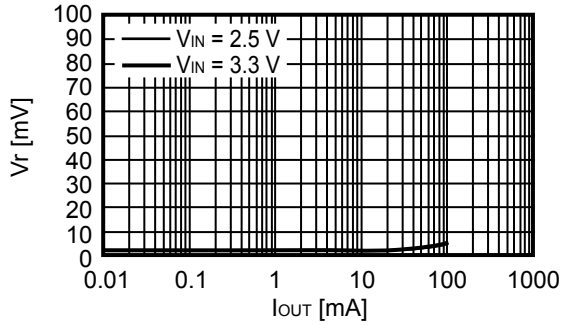

(2)  $f_{osc} = 650\text{ kHz}$ , MaxDuty = 73%  
 ( $R_{OSC} = 200\text{ k}\Omega$ ,  $R_{Duty} = 300\text{ k}\Omega$ )

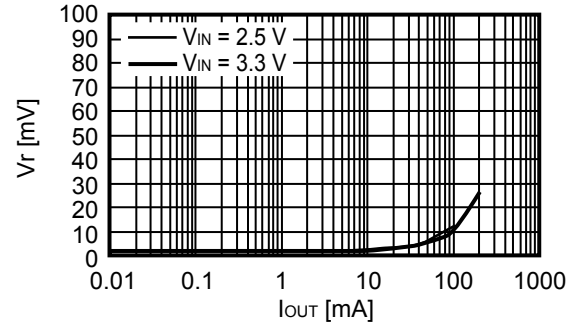

(3)  $f_{osc} = 280\text{ kHz}$ , MaxDuty = 73%  
 ( $R_{OSC} = 470\text{ k}\Omega$ ,  $R_{Duty} = 750\text{ k}\Omega$ )

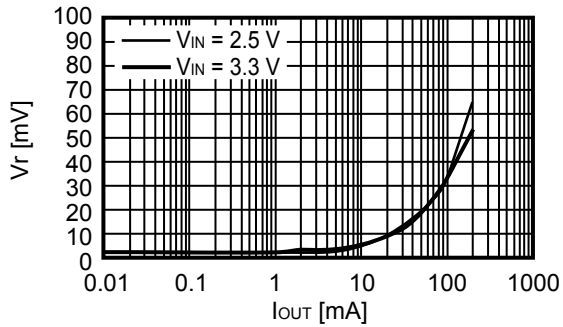

## ■ Marking Specifications

### 1. SNT-8A



- (1): Blank
- (2) to (4): Product code (Refer to **Product name vs. Product code**)
- (5), (6): Blank
- (7) to (11): Lot number

#### Product name vs. Product code

| Product name     | Product code |     |     |
|------------------|--------------|-----|-----|
|                  | (2)          | (3) | (4) |
| S-8333CAAA-I8T1U | U            | 2   | A   |
| S-8333CAAB-I8T1U | U            | 2   | B   |
| S-8333CAAC-I8T1U | U            | 2   | C   |
| S-8333CABA-I8T1U | U            | 2   | D   |
| S-8333CABB-I8T1U | U            | 2   | E   |
| S-8333CABC-I8T1U | U            | 2   | F   |
| S-8333CACA-I8T1U | U            | 2   | G   |
| S-8333CACB-I8T1U | U            | 2   | H   |
| S-8333CACC-I8T1U | U            | 2   | I   |
| S-8333CADA-I8T1U | U            | 2   | J   |
| S-8333CADB-I8T1U | U            | 2   | K   |
| S-8333CADC-I8T1U | U            | 2   | L   |
| S-8333CAEA-I8T1U | U            | 2   | M   |
| S-8333CAEB-I8T1U | U            | 2   | N   |
| S-8333CAEC-I8T1U | U            | 2   | O   |
| S-8333CAFA-I8T1U | U            | 2   | P   |
| S-8333CAFB-I8T1U | U            | 2   | Q   |
| S-8333CAFC-I8T1U | U            | 2   | R   |
| S-8333CAGA-I8T1U | U            | 2   | S   |
| S-8333CAGB-I8T1U | U            | 2   | T   |
| S-8333CAGC-I8T1U | U            | 2   | U   |
| S-8333CAHA-I8T1U | U            | 2   | V   |
| S-8333CAHB-I8T1U | U            | 2   | W   |
| S-8333CAHC-I8T1U | U            | 2   | X   |
| S-8333CAIA-I8T1U | U            | 2   | Y   |
| S-8333CAIB-I8T1U | U            | 2   | Z   |
| S-8333CAIC-I8T1U | U            | 2   | 3   |
| S-8333CBAA-I8T1U | U            | 3   | A   |
| S-8333CBAB-I8T1U | U            | 3   | B   |
| S-8333CBAC-I8T1U | U            | 3   | C   |
| S-8333CBBA-I8T1U | U            | 3   | D   |
| S-8333CBBB-I8T1U | U            | 3   | E   |
| S-8333CBBC-I8T1U | U            | 3   | F   |
| S-8333CBCA-I8T1U | U            | 3   | G   |
| S-8333CBCB-I8T1U | U            | 3   | H   |
| S-8333CBCC-I8T1U | U            | 3   | I   |
| S-8333CBDA-I8T1U | U            | 3   | J   |
| S-8333CBDB-I8T1U | U            | 3   | K   |
| S-8333CBDC-I8T1U | U            | 3   | L   |
| S-8333CBEA-I8T1U | U            | 3   | M   |
| S-8333CBEB-I8T1U | U            | 3   | N   |

| Product name     | Product code |     |     |
|------------------|--------------|-----|-----|
|                  | (2)          | (3) | (4) |
| S-8333CBEC-I8T1U | U            | 3   | O   |
| S-8333CBFA-I8T1U | U            | 3   | P   |
| S-8333CBFB-I8T1U | U            | 3   | Q   |
| S-8333CBFC-I8T1U | U            | 3   | R   |
| S-8333CBGA-I8T1U | U            | 3   | S   |
| S-8333CBGB-I8T1U | U            | 3   | T   |
| S-8333CBGC-I8T1U | U            | 3   | U   |
| S-8333CBHA-I8T1U | U            | 3   | V   |
| S-8333CBHB-I8T1U | U            | 3   | W   |
| S-8333CBHC-I8T1U | U            | 3   | X   |
| S-8333CBIA-I8T1U | U            | 3   | Y   |
| S-8333CBIB-I8T1U | U            | 3   | Z   |
| S-8333CBIC-I8T1U | U            | 3   | 3   |
| S-8333CCAA-I8T1U | U            | 4   | A   |
| S-8333CCAB-I8T1U | U            | 4   | B   |
| S-8333CCAC-I8T1U | U            | 4   | C   |
| S-8333CCBA-I8T1U | U            | 4   | D   |
| S-8333CCBB-I8T1U | U            | 4   | E   |
| S-8333CCBC-I8T1U | U            | 4   | F   |
| S-8333CCCA-I8T1U | U            | 4   | G   |
| S-8333CCCB-I8T1U | U            | 4   | H   |
| S-8333CCCC-I8T1U | U            | 4   | I   |
| S-8333CCDA-I8T1U | U            | 4   | J   |
| S-8333CCDB-I8T1U | U            | 4   | K   |
| S-8333CCDC-I8T1U | U            | 4   | L   |
| S-8333CCEA-I8T1U | U            | 4   | M   |
| S-8333CCEB-I8T1U | U            | 4   | N   |
| S-8333CCEC-I8T1U | U            | 4   | O   |
| S-8333CCFA-I8T1U | U            | 4   | P   |
| S-8333CCFB-I8T1U | U            | 4   | Q   |
| S-8333CCFC-I8T1U | U            | 4   | R   |
| S-8333CCGA-I8T1U | U            | 4   | S   |
| S-8333CCGB-I8T1U | U            | 4   | T   |
| S-8333CCGC-I8T1U | U            | 4   | U   |
| S-8333CCHA-I8T1U | U            | 4   | V   |
| S-8333CCHB-I8T1U | U            | 4   | W   |
| S-8333CCHC-I8T1U | U            | 4   | X   |
| S-8333CCIA-I8T1U | U            | 4   | Y   |
| S-8333CCIB-I8T1U | U            | 4   | Z   |
| S-8333CCIC-I8T1U | U            | 4   | 3   |

## 2. 8-Pin TSSOP

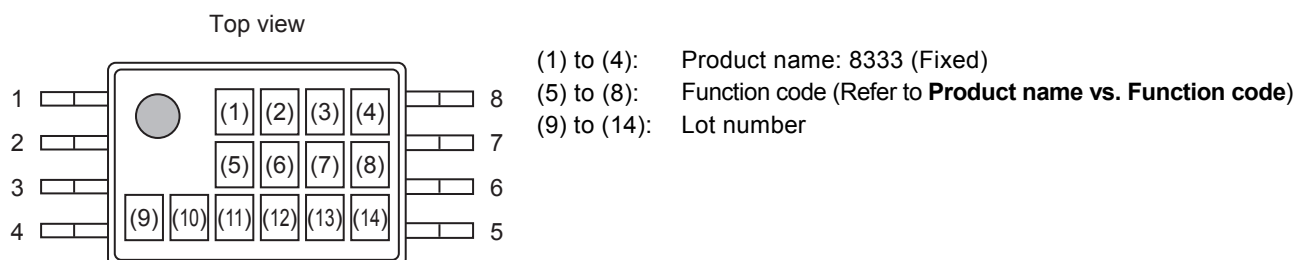

### Product name vs. Function code

| Product name     | Function code |     |     |     |
|------------------|---------------|-----|-----|-----|
|                  | (5)           | (6) | (7) | (8) |
| S-8333CAAA-T8T1y | C             | A   | A   | A   |
| S-8333CAAB-T8T1y | C             | A   | A   | B   |
| S-8333CAAC-T8T1y | C             | A   | A   | C   |
| S-8333CABA-T8T1y | C             | A   | B   | A   |
| S-8333CABB-T8T1y | C             | A   | B   | B   |
| S-8333CABC-T8T1y | C             | A   | B   | C   |
| S-8333CACA-T8T1y | C             | A   | C   | A   |
| S-8333CACB-T8T1y | C             | A   | C   | B   |
| S-8333CACC-T8T1y | C             | A   | C   | C   |
| S-8333CADA-T8T1y | C             | A   | D   | A   |
| S-8333CADB-T8T1y | C             | A   | D   | B   |
| S-8333CADC-T8T1y | C             | A   | D   | C   |
| S-8333CAEA-T8T1y | C             | A   | E   | A   |
| S-8333CAEB-T8T1y | C             | A   | E   | B   |
| S-8333CAEC-T8T1y | C             | A   | E   | C   |
| S-8333CAFA-T8T1y | C             | A   | F   | A   |
| S-8333CAFB-T8T1y | C             | A   | F   | B   |
| S-8333CAFC-T8T1y | C             | A   | F   | C   |
| S-8333CAGA-T8T1y | C             | A   | G   | A   |
| S-8333CAGB-T8T1y | C             | A   | G   | B   |
| S-8333CAGC-T8T1y | C             | A   | G   | C   |
| S-8333CAHA-T8T1y | C             | A   | H   | A   |
| S-8333CAHB-T8T1y | C             | A   | H   | B   |
| S-8333CAHC-T8T1y | C             | A   | H   | C   |
| S-8333CAIA-T8T1y | C             | A   | I   | A   |
| S-8333CAIB-T8T1y | C             | A   | I   | B   |
| S-8333CAIC-T8T1y | C             | A   | I   | C   |
| S-8333CBAA-T8T1y | C             | B   | A   | A   |
| S-8333CBAB-T8T1y | C             | B   | A   | B   |
| S-8333CBAC-T8T1y | C             | B   | A   | C   |
| S-8333CBBA-T8T1y | C             | B   | B   | A   |
| S-8333CBBB-T8T1y | C             | B   | B   | B   |
| S-8333CBBC-T8T1y | C             | B   | B   | C   |
| S-8333CBCA-T8T1y | C             | B   | C   | A   |
| S-8333CBCB-T8T1y | C             | B   | C   | B   |
| S-8333CBCC-T8T1y | C             | B   | C   | C   |
| S-8333CBDA-T8T1y | C             | B   | D   | A   |
| S-8333CBDB-T8T1y | C             | B   | D   | B   |
| S-8333CBDC-T8T1y | C             | B   | D   | C   |
| S-8333CBEA-T8T1y | C             | B   | E   | A   |
| S-8333CBEB-T8T1y | C             | B   | E   | B   |

| Product name     | Function code |     |     |     |
|------------------|---------------|-----|-----|-----|
|                  | (5)           | (6) | (7) | (8) |
| S-8333CBEC-T8T1y | C             | B   | E   | C   |
| S-8333CBFA-T8T1y | C             | B   | F   | A   |
| S-8333CBFB-T8T1y | C             | B   | F   | B   |
| S-8333CBFC-T8T1y | C             | B   | F   | C   |
| S-8333CBGA-T8T1y | C             | B   | G   | A   |
| S-8333CBGB-T8T1y | C             | B   | G   | B   |
| S-8333CBGC-T8T1y | C             | B   | G   | C   |
| S-8333CBHA-T8T1y | C             | B   | H   | A   |
| S-8333CBHB-T8T1y | C             | B   | H   | B   |
| S-8333CBHC-T8T1y | C             | B   | H   | C   |
| S-8333CBIA-T8T1y | C             | B   | I   | A   |
| S-8333CBIB-T8T1y | C             | B   | I   | B   |
| S-8333CBIC-T8T1y | C             | B   | I   | C   |
| S-8333CCAA-T8T1y | C             | C   | A   | A   |
| S-8333CCAB-T8T1y | C             | C   | A   | B   |
| S-8333CCAC-T8T1y | C             | C   | A   | C   |
| S-8333CCBA-T8T1y | C             | C   | B   | A   |
| S-8333CCBB-T8T1y | C             | C   | B   | B   |
| S-8333CCBC-T8T1y | C             | C   | B   | C   |
| S-8333CCCA-T8T1y | C             | C   | C   | A   |
| S-8333CCCB-T8T1y | C             | C   | C   | B   |
| S-8333CCCC-T8T1y | C             | C   | C   | C   |
| S-8333CCDA-T8T1y | C             | C   | D   | A   |
| S-8333CCDB-T8T1y | C             | C   | D   | B   |
| S-8333CCDC-T8T1y | C             | C   | D   | C   |
| S-8333CCEA-T8T1y | C             | C   | E   | A   |
| S-8333CCEB-T8T1y | C             | C   | E   | B   |
| S-8333CCEC-T8T1y | C             | C   | E   | C   |
| S-8333CCFA-T8T1y | C             | C   | F   | A   |
| S-8333CCFB-T8T1y | C             | C   | F   | B   |
| S-8333CCFC-T8T1y | C             | C   | F   | C   |
| S-8333CCGA-T8T1y | C             | C   | G   | A   |
| S-8333CCGB-T8T1y | C             | C   | G   | B   |
| S-8333CCGC-T8T1y | C             | C   | G   | C   |
| S-8333CCHA-T8T1y | C             | C   | H   | A   |
| S-8333CCHB-T8T1y | C             | C   | H   | B   |
| S-8333CCHC-T8T1y | C             | C   | H   | C   |
| S-8333CCIA-T8T1y | C             | C   | I   | A   |
| S-8333CCIB-T8T1y | C             | C   | I   | B   |
| S-8333CCIC-T8T1y | C             | C   | I   | C   |

**Remark 1.** y: S or U

2. Please select products of environmental code = U for Sn 100%, halogen-free products.



No. PH008-A-P-SD-2.0

|                               |                         |
|-------------------------------|-------------------------|
| TITLE                         | SNT-8A-A-PKG Dimensions |
| No.                           | PH008-A-P-SD-2.0        |
| SCALE                         |                         |
| UNIT                          | mm                      |
|                               |                         |
| SII Semiconductor Corporation |                         |



Feed direction

No. PH008-A-C-SD-1.0

|                               |                       |
|-------------------------------|-----------------------|
| TITLE                         | SNT-8A-A-Carrier Tape |
| No.                           | PH008-A-C-SD-1.0      |
| SCALE                         |                       |
| UNIT                          | mm                    |
|                               |                       |
| SII Semiconductor Corporation |                       |



Enlarged drawing in the central part



No. PH008-A-R-SD-1.0

|                               |                  |      |       |
|-------------------------------|------------------|------|-------|
| TITLE                         | SNT-8A-A-Reel    |      |       |
| No.                           | PH008-A-R-SD-1.0 |      |       |
| SCALE                         |                  | QTY. | 5,000 |
| UNIT                          | mm               |      |       |
|                               |                  |      |       |
| SII Semiconductor Corporation |                  |      |       |



※1. ランドパターンの幅に注意してください (0.25 mm min. / 0.30 mm typ.).  
 ※2. パッケージ中央にランドパターンを広げないでください (1.96 mm ~ 2.06 mm)。

- 注意
1. パッケージのモールド樹脂下にシルク印刷やハンダ印刷などしないでください。
  2. パッケージ下の配線上のソルダーレジストなどの厚みをランドパターン表面から0.03 mm以下にしてください。
  3. マスク開口サイズと開口位置はランドパターンと合わせてください。
  4. 詳細は "SNTパッケージ活用の手引き" を参照してください。

※1. Pay attention to the land pattern width (0.25 mm min. / 0.30 mm typ.).  
 ※2. Do not widen the land pattern to the center of the package (1.96 mm to 2.06mm).

- Caution**
1. Do not do silkscreen printing and solder printing under the mold resin of the package.
  2. The thickness of the solder resist on the wire pattern under the package should be 0.03 mm or less from the land pattern surface.
  3. Match the mask aperture size and aperture position with the land pattern.
  4. Refer to "SNT Package User's Guide" for details.

※1. 请注意焊盘模式的宽度 (0.25 mm min. / 0.30 mm typ.).  
 ※2. 请勿向封装中间扩展焊盘模式 (1.96 mm ~ 2.06 mm)。

- 注意
1. 请勿在树脂型封装的下面印刷丝网、焊锡。
  2. 在封装下、布线上的阻焊膜厚度 (从焊盘模式表面起) 请控制在 0.03 mm 以下。
  3. 钢网的开口尺寸和开口位置请与焊盘模式对齐。
  4. 详细内容请参阅 "SNT 封装的应用指南"。

No. PH008-A-L-SD-4.1

|                               |                                  |
|-------------------------------|----------------------------------|
| TITLE                         | SNT-8A-A<br>-Land Recommendation |
| No.                           | PH008-A-L-SD-4.1                 |
| SCALE                         |                                  |
| UNIT                          | mm                               |
| SII Semiconductor Corporation |                                  |



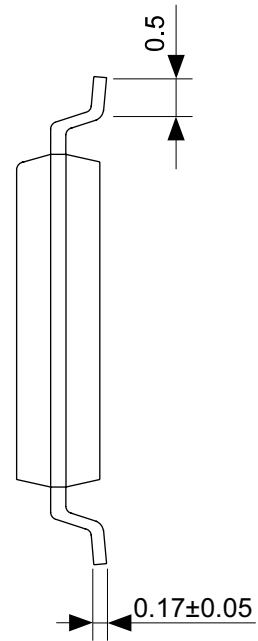

No. FT008-A-P-SD-1.1

|                               |                         |
|-------------------------------|-------------------------|
| TITLE                         | TSSOP8-E-PKG Dimensions |
| No.                           | FT008-A-P-SD-1.1        |
| SCALE                         |                         |
| UNIT                          | mm                      |
|                               |                         |
| SII Semiconductor Corporation |                         |



No. FT008-E-C-SD-1.0

|                               |                       |
|-------------------------------|-----------------------|
| TITLE                         | TSSOP8-E-Carrier Tape |
| No.                           | FT008-E-C-SD-1.0      |
| SCALE                         |                       |
| UNIT                          | mm                    |
| SII Semiconductor Corporation |                       |



Enlarged drawing in the central part



No. FT008-E-R-SD-1.0

|                               |                  |      |       |
|-------------------------------|------------------|------|-------|
| TITLE                         | TSSOP8-E-Reel    |      |       |
| No.                           | FT008-E-R-SD-1.0 |      |       |
| SCALE                         |                  | QTY. | 3,000 |
| UNIT                          | mm               |      |       |
|                               |                  |      |       |
| SII Semiconductor Corporation |                  |      |       |

## Disclaimers (Handling Precautions)

1. All the information described herein (product data, specifications, figures, tables, programs, algorithms and application circuit examples, etc.) is current as of publishing date of this document and is subject to change without notice.
2. The circuit examples and the usages described herein are for reference only, and do not guarantee the success of any specific mass-production design.  
SII Semiconductor Corporation is not responsible for damages caused by the reasons other than the products or infringement of third-party intellectual property rights and any other rights due to the use of the information described herein.
3. SII Semiconductor Corporation is not responsible for damages caused by the incorrect information described herein.
4. Take care to use the products described herein within their specified ranges. Pay special attention to the absolute maximum ratings, operation voltage range and electrical characteristics, etc.  
SII Semiconductor Corporation is not responsible for damages caused by failures and/or accidents, etc. that occur due to the use of products outside their specified ranges.
5. When using the products described herein, confirm their applications, and the laws and regulations of the region or country where they are used and verify suitability, safety and other factors for the intended use.
6. When exporting the products described herein, comply with the Foreign Exchange and Foreign Trade Act and all other export-related laws, and follow the required procedures.
7. The products described herein must not be used or provided (exported) for the purposes of the development of weapons of mass destruction or military use. SII Semiconductor Corporation is not responsible for any provision (export) to those whose purpose is to develop, manufacture, use or store nuclear, biological or chemical weapons, missiles, or other military use.
8. The products described herein are not designed to be used as part of any device or equipment that may affect the human body, human life, or assets (such as medical equipment, disaster prevention systems, security systems, combustion control systems, infrastructure control systems, vehicle equipment, traffic systems, in-vehicle equipment, aviation equipment, aerospace equipment, and nuclear-related equipment), excluding when specified for in-vehicle use or other uses. Do not use those products without the prior written permission of SII Semiconductor Corporation. Especially, the products described herein cannot be used for life support devices, devices implanted in the human body and devices that directly affect human life, etc.  
Prior consultation with our sales office is required when considering the above uses.  
SII Semiconductor Corporation is not responsible for damages caused by unauthorized or unspecified use of our products.
9. Semiconductor products may fail or malfunction with some probability.  
The user of these products should therefore take responsibility to give thorough consideration to safety design including redundancy, fire spread prevention measures, and malfunction prevention to prevent accidents causing injury or death, fires and social damage, etc. that may ensue from the products' failure or malfunction.  
The entire system must be sufficiently evaluated and applied on customer's own responsibility.
10. The products described herein are not designed to be radiation-proof. The necessary radiation measures should be taken in the product design by the customer depending on the intended use.
11. The products described herein do not affect human health under normal use. However, they contain chemical substances and heavy metals and should therefore not be put in the mouth. The fracture surfaces of wafers and chips may be sharp. Take care when handling these with the bare hands to prevent injuries, etc.
12. When disposing of the products described herein, comply with the laws and ordinances of the country or region where they are used.
13. The information described herein contains copyright information and know-how of SII Semiconductor Corporation.  
The information described herein does not convey any license under any intellectual property rights or any other rights belonging to SII Semiconductor Corporation or a third party. Reproduction or copying of the information described herein for the purpose of disclosing it to a third-party without the express permission of SII Semiconductor Corporation is strictly prohibited.
14. For more details on the information described herein, contact our sales office.

1.0-2016.01



# Mouser Electronics

Authorized Distributor

Click to View Pricing, Inventory, Delivery & Lifecycle Information:

## Seiko Instruments:

[S-8333AAAA-T8T1G](#) [S-8333AAAB-T8T1G](#) [S-8333AAAC-T8T1G](#) [S-8333AABA-T8T1G](#) [S-8333AABB-T8T1G](#) [S-8333AABC-T8T1G](#) [S-8333AACA-T8T1G](#) [S-8333AACB-T8T1G](#) [S-8333AACC-T8T1G](#) [S-8333AADA-T8T1G](#) [S-8333AADB-T8T1G](#) [S-8333AADC-T8T1G](#) [S-8333AAEA-T8T1G](#) [S-8333AAEB-T8T1G](#) [S-8333AAEC-T8T1G](#) [S-8333AAFA-T8T1G](#) [S-8333AAFB-T8T1G](#) [S-8333AAFC-T8T1G](#) [S-8333AAGA-T8T1G](#) [S-8333AAGB-T8T1G](#) [S-8333AAGC-T8T1G](#) [S-8333AAHA-T8T1G](#) [S-8333AAHB-T8T1G](#) [S-8333AAHC-T8T1G](#) [S-8333AAIA-T8T1G](#) [S-8333AAIB-T8T1G](#) [S-8333AAIC-T8T1G](#) [S-8333ABAA-T8T1G](#) [S-8333ABAB-T8T1G](#) [S-8333ABAC-T8T1G](#) [S-8333ABBA-T8T1G](#) [S-8333ABBB-T8T1G](#) [S-8333ABBC-T8T1G](#) [S-8333ABCA-T8T1G](#) [S-8333ABCB-T8T1G](#) [S-8333ABCC-T8T1G](#) [S-8333ABDA-T8T1G](#) [S-8333ABDB-T8T1G](#) [S-8333ABDC-T8T1G](#) [S-8333ABEA-T8T1G](#) [S-8333ABEB-T8T1G](#) [S-8333ABEC-T8T1G](#) [S-8333ABFA-T8T1G](#) [S-8333ABFB-T8T1G](#) [S-8333ABFC-T8T1G](#) [S-8333ABGA-T8T1G](#) [S-8333ABGB-T8T1G](#) [S-8333ABGC-T8T1G](#) [S-8333ABHA-T8T1G](#) [S-8333ABHB-T8T1G](#) [S-8333ABHC-T8T1G](#) [S-8333ABIA-T8T1G](#) [S-8333ABIB-T8T1G](#) [S-8333ABIC-T8T1G](#) [S-8333ACAA-T8T1G](#) [S-8333ACAB-T8T1G](#) [S-8333ACAC-T8T1G](#) [S-8333ACBA-T8T1G](#) [S-8333ACBB-T8T1G](#) [S-8333ACBC-T8T1G](#) [S-8333ACCA-T8T1G](#) [S-8333ACCB-T8T1G](#) [S-8333ACCC-T8T1G](#) [S-8333ACDA-T8T1G](#) [S-8333ACDB-T8T1G](#) [S-8333ACDC-T8T1G](#) [S-8333ACEA-T8T1G](#) [S-8333ACEB-T8T1G](#) [S-8333ACEC-T8T1G](#) [S-8333ACFA-T8T1G](#) [S-8333ACFB-T8T1G](#) [S-8333ACFC-T8T1G](#) [S-8333ACGA-T8T1G](#) [S-8333ACGB-T8T1G](#) [S-8333ACGC-T8T1G](#) [S-8333ACHA-T8T1G](#) [S-8333ACHB-T8T1G](#) [S-8333ACHC-T8T1G](#) [S-8333ACIA-T8T1G](#) [S-8333ACIB-T8T1G](#) [S-8333ACIC-T8T1G](#) [S-8333ABIC-I8T1U](#) [S-8333ACFB-I8T1U](#) [S-8333ABHB-I8T1U](#) [S-8333ABGA-I8T1U](#) [S-8333ABAB-I8T1U](#) [S-8333AABA-I8T1U](#) [S-8333ABIB-I8T1U](#) [S-8333ACCB-I8T1U](#) [S-8333ABEC-I8T1U](#) [S-8333ABIA-I8T1U](#) [S-8333ACGB-I8T1U](#) [S-8333ABAA-I8T1U](#) [S-8333ABCB-I8T1U](#) [S-8333ABGC-I8T1U](#) [S-8333ABEB-I8T1U](#) [S-8333ABHC-I8T1U](#) [S-8333AABC-I8T1U](#) [S-8333AAIA-I8T1U](#) [S-8333ACEB-I8T1U](#)



Компания «ЭлектроПласт» предлагает заключение долгосрочных отношений при поставках импортных электронных компонентов на взаимовыгодных условиях!

Наши преимущества:

- Оперативные поставки широкого спектра электронных компонентов отечественного и импортного производства напрямую от производителей и с крупнейших мировых складов;
- Поставка более 17-ти миллионов наименований электронных компонентов;
- Поставка сложных, дефицитных, либо снятых с производства позиций;
- Оперативные сроки поставки под заказ (от 5 рабочих дней);
- Экспресс доставка в любую точку России;
- Техническая поддержка проекта, помощь в подборе аналогов, поставка прототипов;
- Система менеджмента качества сертифицирована по Международному стандарту ISO 9001;
- Лицензия ФСБ на осуществление работ с использованием сведений, составляющих государственную тайну;
- Поставка специализированных компонентов (Xilinx, Altera, Analog Devices, Intersil, Interpoint, Microsemi, Aeroflex, Peregrine, Syfer, Eurofarad, Texas Instrument, Miteq, Cobham, E2V, MA-COM, Hittite, Mini-Circuits, General Dynamics и др.);

Помимо этого, одним из направлений компании «ЭлектроПласт» является направление «Источники питания». Мы предлагаем Вам помощь Конструкторского отдела:

- Подбор оптимального решения, техническое обоснование при выборе компонента;
- Подбор аналогов;
- Консультации по применению компонента;
- Поставка образцов и прототипов;
- Техническая поддержка проекта;
- Защита от снятия компонента с производства.



#### Как с нами связаться

**Телефон:** 8 (812) 309 58 32 (многоканальный)

**Факс:** 8 (812) 320-02-42

**Электронная почта:** [org@eplast1.ru](mailto:org@eplast1.ru)

**Адрес:** 198099, г. Санкт-Петербург, ул. Калинина, дом 2, корпус 4, литера А.