

## HIH-4000 Series

---

### Humidity Sensors

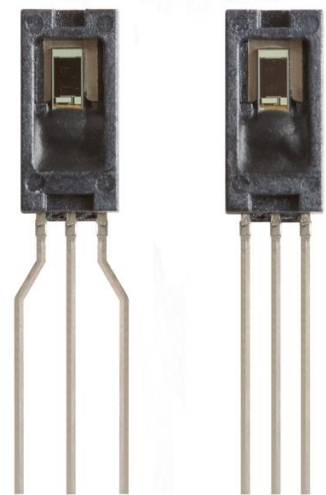

#### DESCRIPTION

The HIH-4000 Series Humidity Sensors are designed specifically for high volume OEM (Original Equipment Manufacturer) users.

Direct input to a controller or other device is made possible by this sensor's near linear voltage output. With a typical current draw of only 200  $\mu$ A, the HIH-4000 Series is often ideally suited for low drain, battery operated systems.

Tight sensor interchangeability reduces or eliminates OEM production calibration costs. Individual sensor calibration data is available.

#### FEATURES

---

- Molded thermoset plastic housing
- Near linear voltage output vs % RH
- Laser trimmed interchangeability
- Low power design
- Enhanced accuracy
- Fast response time
- Stable, low drift performance
- Chemically resistant

The HIH-4000 Series delivers instrumentation-quality RH (Relative Humidity) sensing performance in a competitively priced, solderable SIP (Single In-line Package).

Available in two lead spacing configurations, the RH sensor is a laser trimmed, thermoset polymer capacitive sensing element with on-chip integrated signal conditioning.

The sensing element's multilayer construction provides excellent resistance to most application hazards such as wetting, dust, dirt, oils and common environmental chemicals.

#### POTENTIAL APPLICATIONS

---

- Refrigeration equipment
- HVAC (Heating, Ventilation and Air Conditioning) equipment
- Medical equipment
- Drying
- Metrology
- Battery-powered systems
- OEM assemblies

# HIH-4000 Series

**Table 1. Performance Specifications (At 5 Vdc supply and 25 °C [77 °F] unless otherwise noted.)**

| Parameter  | Minimum  | Typical       | Maximum  | Unit   | Specific Note |
|--|--|---------------|----------|--------|---------------|
| Interchangeability (first order curve)                 | –  | –             | –        | –      | –             |
| 0% RH to 59% RH  | -5   | –             | 5        | % RH   | –             |
| 60% RH to 100% RH                                      | -8   | –             | 8        | % RH   | –             |
| Accuracy (best fit straight line)                      | -3.5   | –             | +3.5     | % RH   | 1             |
| Hysteresis   | –  | 3             | –        | % RH   | –             |
| Repeatability  | –  | ±0.5          | –        | % RH   | –             |
| Settling time  | –  | –             | 70       | ms     | –             |
| Response time (1/e in slow moving air)                 | –  | 5             | –        | s      | –             |
| Stability (at 50% RH)                                  | –  | 1.2           | –        | % RH   | –             |
| Voltage supply   | 4  | –             | 5.8      | Vdc    | 2             |
| Current supply   | –  | 200           | 500      | µA     | –             |
| Voltage output (1 <sup>st</sup> order curve fit)       | $V_{OUT} = (V_{SUPPLY})(0.0062(\text{sensor RH}) + 0.16)$ , typical at 25 °C |               |          |        |               |
| Temperature compensation                               | True RH = (Sensor RH)/(1.0546 – 0.00216T), T in °C                           |               |          |        |               |
| Output voltage temperature, coefficient at 50% RH, 5 V | –  | -4            | –        | mV/°C  | –             |
| Operating temperature                                  | -40[-40]   | See Figure 1. | 85[185]  | °C[°F] | –             |
| Operating humidity                                     | 0  | See Figure 1. | 100      | % RH   | 3             |
| Storage temperature                                    | -50[-58]   | –             | 125[257] | °C[°F] | –             |
| Storage humidity                                       | See Figure 2.  |               |          | % RH   | 3             |

**Specific Notes:**

- Can only be achieved with the supplied slope and offset.  
For HIH-4000-003 and HIH-4000-004 catalog listings only.
- Device is calibrated at 5 Vdc and 25 °C.
- Non-condensing environment.

**General Notes:**

- Sensor is ratiometric to supply voltage.
- Extended exposure to ≥90% RH causes a reversible shift of 3% RH.
- Sensor is light sensitive. For best performance, shield sensor from bright light.

**FACTORY CALIBRATION DATA**

HIH-4000 Sensors may be ordered with a calibration and data printout. See Table 2 and the order guide on the back page.

**Table 2. Example Data Printout**

|   |   |
|---|---|
| Model                                       | HIH-4000-003  |
| Channel                                     | 92  |
| Wafer                                       | 030996M   |
| MRP   | 337313  |
| Calculated values at 5 V                    |   |
| V <sub>OUT</sub> at 0% RH                   | 0.826 V   |
| V <sub>OUT</sub> at 75.3% RH                | 3.198 V   |
| Linear output for 3.5% RH accuracy at 25 °C |   |
| Zero offset                                 | 0.826 V   |
| Slope                                       | 31.483 mV/%RH   |
| RH  | (V <sub>OUT</sub> - zero offset)/slope<br>(V <sub>OUT</sub> - 0.826)/0.0315 |
| Ratiometric response for 0% RH to 100% RH   |   |
| V <sub>OUT</sub>                            | V <sub>SUPPLY</sub> (0.1652 to 0.7952)                                      |



# Humidity Sensors

Figure 1. Operating Environment (Non-condensing environment.)

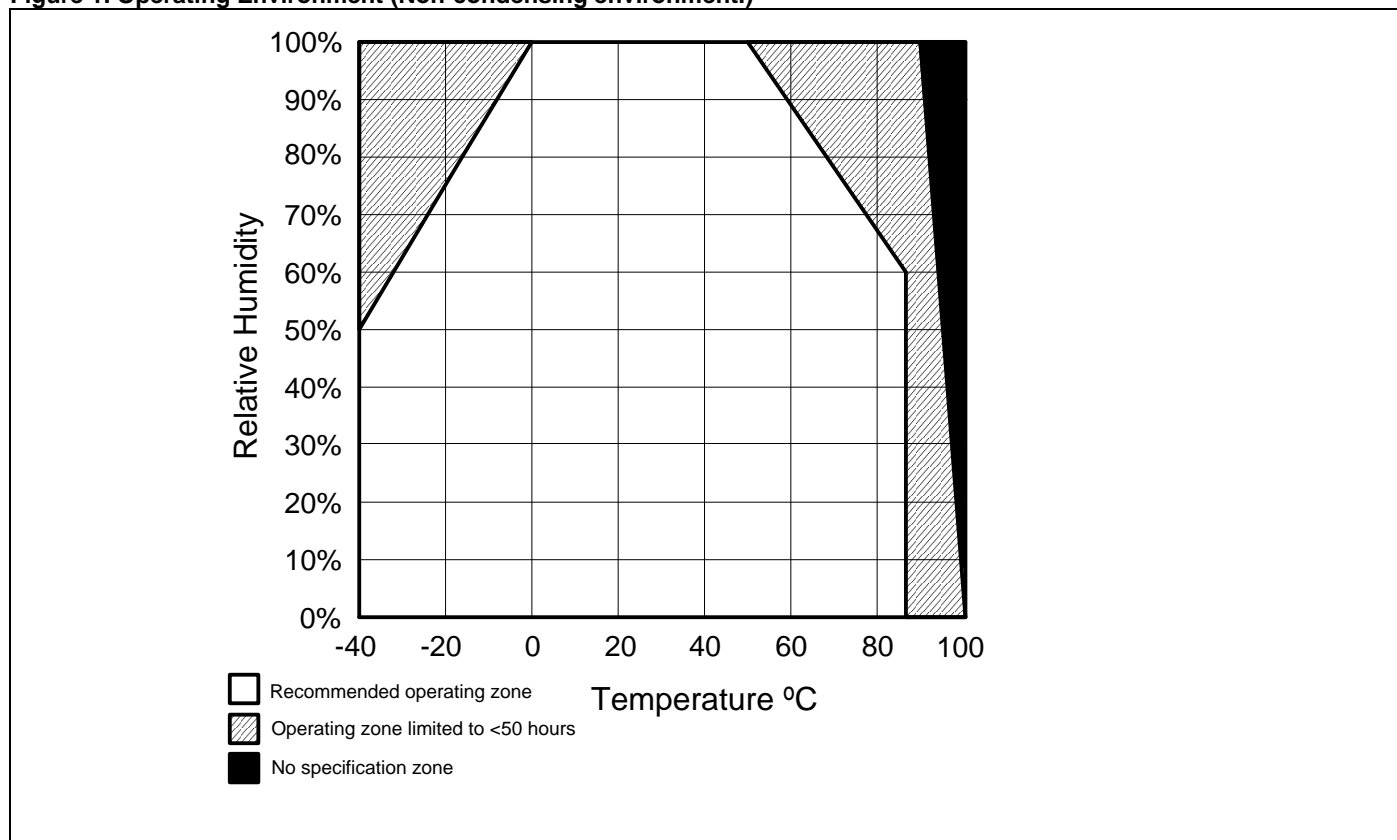
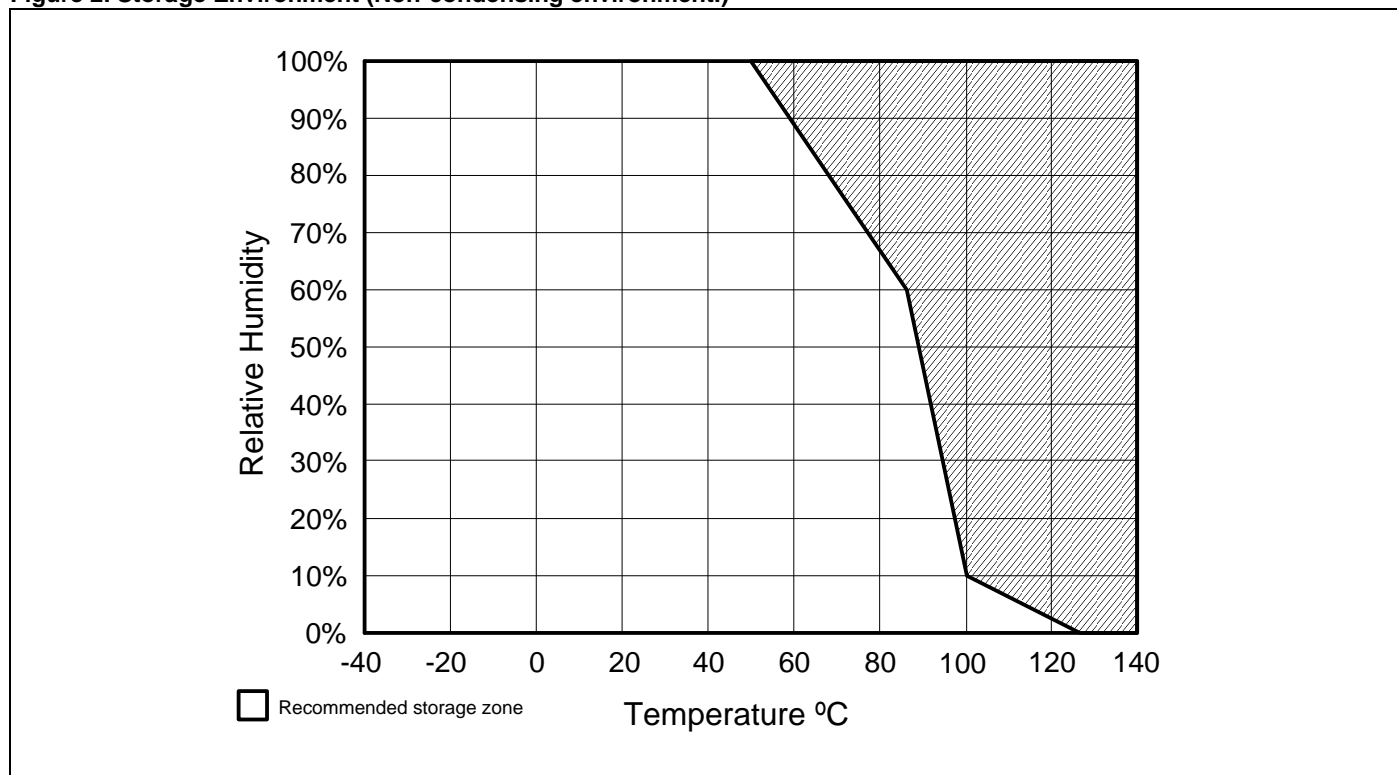

Figure 2. Storage Environment (Non-condensing environment.)



# HIH-4000 Series

Figure 3. Typical Output Voltage vs Relative Humidity (At 25 °C and 5 V.)

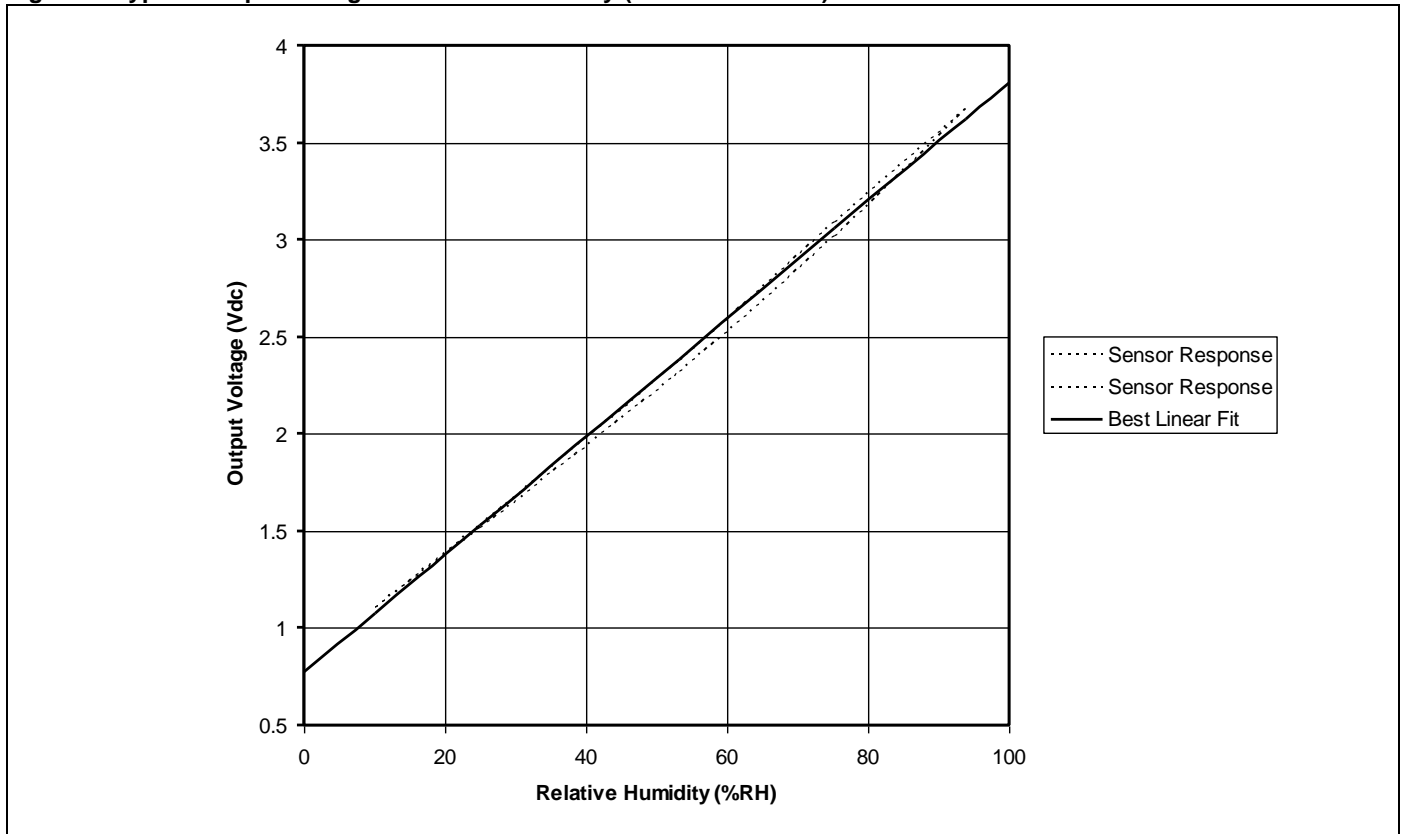
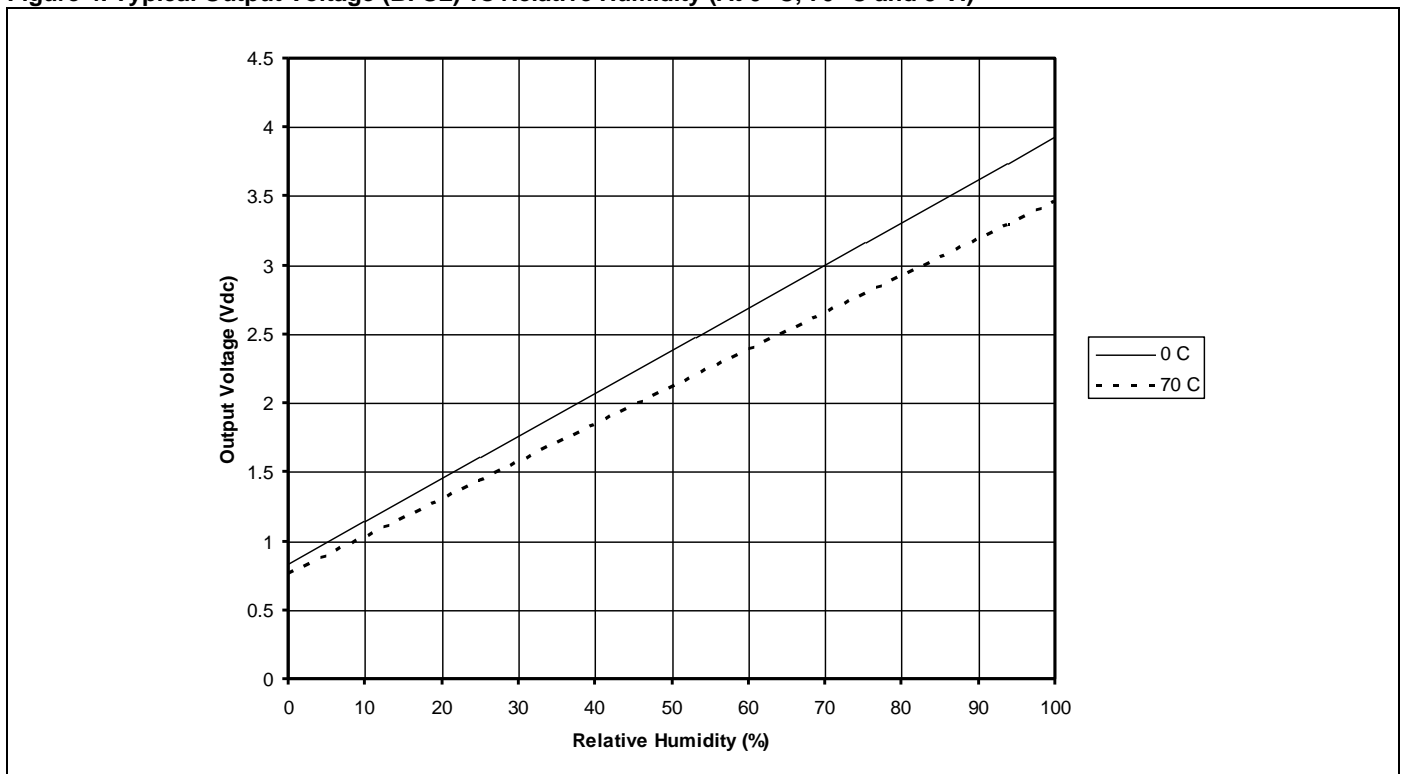

Figure 4. Typical Output Voltage (BFSL) vs Relative Humidity (At 0 °C, 70 °C and 5 V.)



# Humidity Sensors

Figure 5. Mounting Dimensions (For reference only. mm/[in])

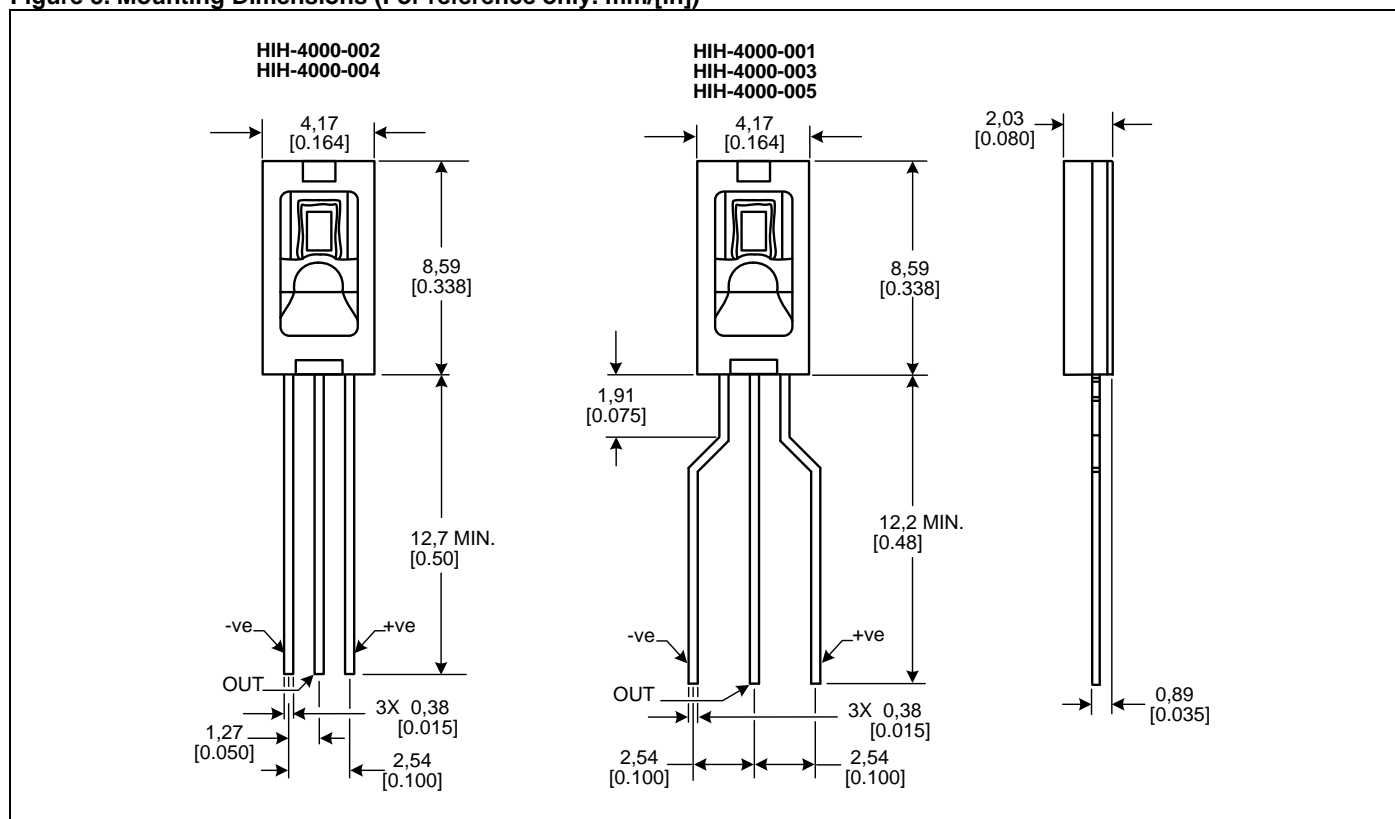
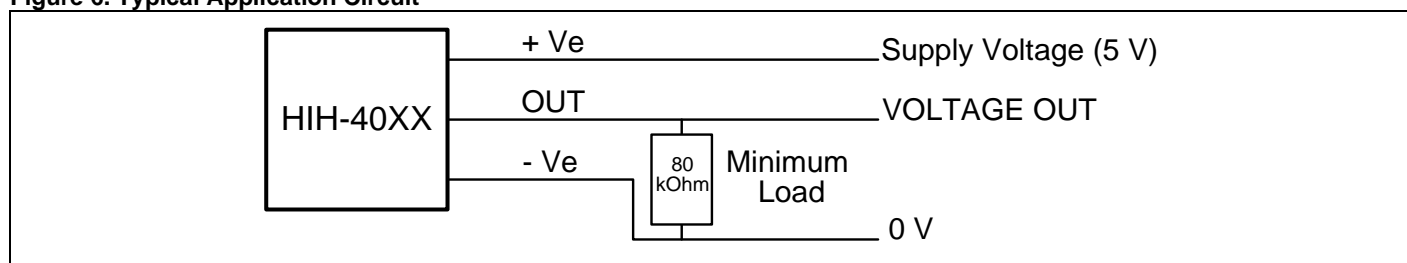

Figure 6. Typical Application Circuit



## ORDER GUIDE

| Catalog Listing | Description  |
|-----------------|--|
| HIH-4000-001    | Integrated circuit humidity sensor, 2,54 mm [0.100 in] lead pitch SIP                                |
| HIH-4000-002    | Integrated circuit humidity sensor, 1,27 mm [0.050 in] lead pitch SIP                                |
| HIH-4000-003    | Integrated circuit humidity sensor, 2,54 mm [0.100 in] lead pitch SIP, calibration and data printout |
| HIH-4000-004    | Integrated circuit humidity sensor, 1,27 mm [0.050 in] lead pitch SIP, calibration and data printout |
| HIH-4000-005    | Equivalent to HIH-4000-001   |

## ADDITIONAL HUMIDITY SENSOR INFORMATION

See the following associated literature at [www.honeywell.com/sensing](http://www.honeywell.com/sensing):

- Product installation instructions
- Application sheets:
  - Humidity Sensor Performance Characteristics
  - Humidity Sensor Theory and Behavior
  - Humidity Sensor Moisture and Psychrometrics
  - Thermoset Polymer-based Capacitive Sensors

## **WARNING**

### **MISUSE OF DOCUMENTATION**

- The information presented in this product sheet is for reference only. Do not use this document as a product installation guide.
- Complete installation, operation, and maintenance information is provided in the instructions supplied with each product.

**Failure to comply with these instructions could result in death or serious injury.**

### **WARRANTY/REMEDY**

Honeywell warrants goods of its manufacture as being free of defective materials and faulty workmanship. Honeywell's standard product warranty applies unless agreed to otherwise by Honeywell in writing; please refer to your order acknowledgement or consult your local sales office for specific warranty details. If warranted goods are returned to Honeywell during the period of coverage, Honeywell will repair or replace, at its option, without charge those items it finds defective. **The foregoing is buyer's sole remedy and is in lieu of all other warranties, expressed or implied, including those of merchantability and fitness for a particular purpose. In no event shall Honeywell be liable for consequential, special, or indirect damages.**

While we provide application assistance personally, through our literature and the Honeywell web site, it is up to the customer to determine the suitability of the product in the application.

Specifications may change without notice. The information we supply is believed to be accurate and reliable as of this printing. However, we assume no responsibility for its use.

## **WARNING**

### **PERSONAL INJURY**

**DO NOT USE** these products as safety or emergency stop devices or in any other application where failure of the product could result in personal injury.

**Failure to comply with these instructions could result in death or serious injury.**

### **SALES AND SERVICE**

Honeywell serves its customers through a worldwide network of sales offices, representatives and distributors. For application assistance, current specifications, pricing or name of the nearest Authorized Distributor, contact your local sales office or:

**E-mail:** [info.sc@honeywell.com](mailto:info.sc@honeywell.com)

**Internet:** [www.honeywell.com/sensing](http://www.honeywell.com/sensing)

### **Phone and Fax:**

|               |   |
|---------------|---|
| Asia Pacific  | +65 6355-2828<br>+65 6445-3033 Fax                        |
| Europe        | +44 (0) 1698 481481<br>+44 (0) 1698 481676 Fax            |
| Latin America | +1-305-805-8188<br>+1-305-883-8257 Fax                    |
| USA/Canada    | +1-800-537-6945<br>+1-815-235-6847<br>+1-815-235-6545 Fax |

Sensing and Control  
Honeywell  
1985 Douglas Drive North  
Golden Valley, MN 55422  
[www.honeywell.com/sensing](http://www.honeywell.com/sensing)

009017-5-EN IL50 GLO Printed in USA  
February 2010  
© 2010 Honeywell International Inc. All rights reserved.

# Honeywell



Компания «ЭлектроПласт» предлагает заключение долгосрочных отношений при поставках импортных электронных компонентов на взаимовыгодных условиях!

Наши преимущества:

- Оперативные поставки широкого спектра электронных компонентов отечественного и импортного производства напрямую от производителей и с крупнейших мировых складов;
- Поставка более 17-ти миллионов наименований электронных компонентов;
- Поставка сложных, дефицитных, либо снятых с производства позиций;
- Оперативные сроки поставки под заказ (от 5 рабочих дней);
- Экспресс доставка в любую точку России;
- Техническая поддержка проекта, помощь в подборе аналогов, поставка прототипов;
- Система менеджмента качества сертифицирована по Международному стандарту ISO 9001;
- Лицензия ФСБ на осуществление работ с использованием сведений, составляющих государственную тайну;
- Поставка специализированных компонентов (Xilinx, Altera, Analog Devices, Intersil, Interpoint, Microsemi, Aeroflex, Peregrine, Syfer, Eurofarad, Texas Instrument, Miteq, Cobham, E2V, MA-COM, Hittite, Mini-Circuits, General Dynamics и др.);

Помимо этого, одним из направлений компании «ЭлектроПласт» является направление «Источники питания». Мы предлагаем Вам помощь Конструкторского отдела:

- Подбор оптимального решения, техническое обоснование при выборе компонента;
- Подбор аналогов;
- Консультации по применению компонента;
- Поставка образцов и прототипов;
- Техническая поддержка проекта;
- Защита от снятия компонента с производства.



#### Как с нами связаться

**Телефон:** 8 (812) 309 58 32 (многоканальный)

**Факс:** 8 (812) 320-02-42

**Электронная почта:** [org@eplast1.ru](mailto:org@eplast1.ru)

**Адрес:** 198099, г. Санкт-Петербург, ул. Калинина, дом 2, корпус 4, литера А.