

PRODUCT NUMBER
SEE TABLE

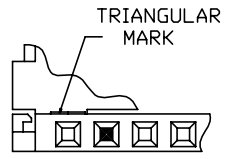
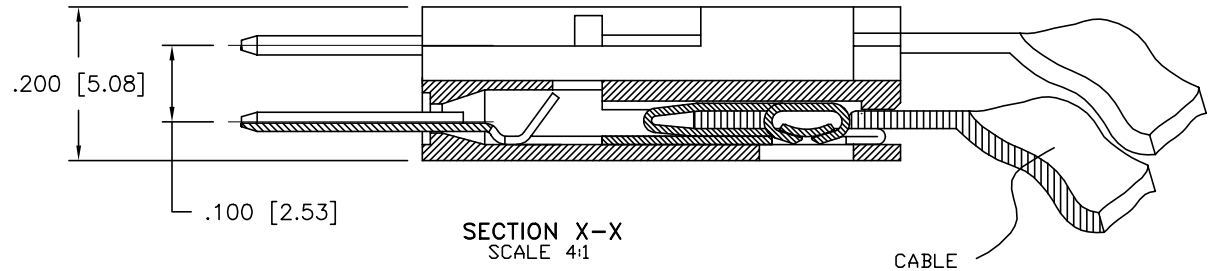
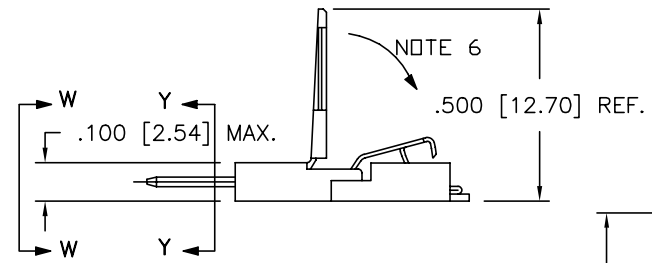
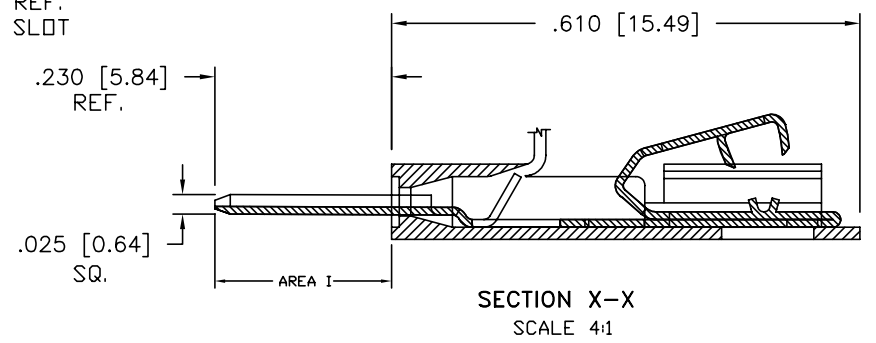
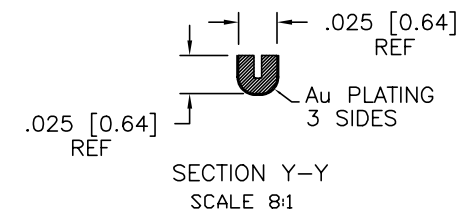
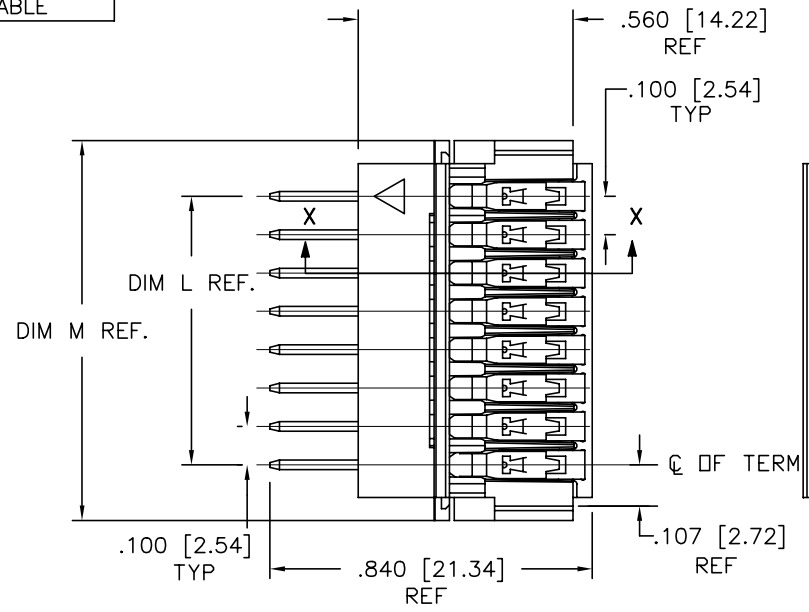

SECTION X-X
SCALE 4:1
CABLE TERMINATED
AND LID CLOSED

mat'l. code		surface ISO 1302 ✓		tolerance ISO 406 ISO 1101		projection INCH/MM		product family CLINCHER	
ltr ecn nodr date		tolerances unless otherwise specified		title		dwg no		sheet 1 of 4 size	
X	ELX-N-011225	ZK	03/30/12	angles	linear	XXXX.01/0.XX10.3	CLINCHER™ PIN ASSEMBLY		
S	V00672	RGD	6/23/00	0°±2'		XXXX.005/0.XX10.13	scale 2:1		
T	V01741	RGD	8/4/00	chr	P.PARSONS	9/13/93	FCI		
U	M05-0154	MHT	6/27/05	engr	T. HANNA	9/13/93	66226		A3
V	M06-0233	AGS	06/13/06	chr	T.BREWBAKER	9/13/93	type Product Customer Drawing		
W	M07-0156	MHT	3/14/07	appd	T. HANNA	9/13/93			
sheet	revision	X	X	X	X				
index	sheet	1	2	3	4				

PRODUCT NO.	NO. OF	DIM L	DIM L	DIM M	DIM M	DIM N	DIM N	PLATING	COLOR
NOTE 8	POSITION	ENGLISH	METRIC	ENGLISH	METRIC	ENGLISH	METRIC	CODE	
66226-001			U N A	S S I G	N E D				
66226-002	2	0.100	2.54	0.390	9.91	0.315	8.00	1	BLUE
66226-003	3	0.200	5.08	0.490	12.45	0.415	10.54	1	BLUE
66226-004	4	0.300	7.62	0.590	14.99	0.515	13.08	1	BLUE
66226-005	5	0.400	10.16	0.690	17.53	0.615	15.62	1	BLUE
66226-006	6	0.500	12.70	0.790	20.07	0.715	18.16	1	BLUE
66226-007	7	0.600	15.24	0.890	22.61	0.815	20.70	1	BLUE
66226-008	8	0.700	17.78	0.990	25.15	0.915	23.24	1	BLUE
66226-009	9	0.800	20.32	1.090	27.69	1.015	25.78	1	BLUE
66226-010	10	0.900	22.86	1.190	30.23	1.115	28.32	1	BLUE
66226-011	11	1.000	25.40	1.290	32.77	1.215	30.86	1	BLUE
66226-012	12	1.100	27.94	1.390	35.31	1.315	33.40	1	BLUE
66226-013	13	1.200	30.48	1.490	37.85	1.415	35.94	1	BLUE
66226-014	14	1.300	33.02	1.590	40.39	1.515	38.48	1	BLUE
66226-015	15	1.400	35.56	1.690	42.93	1.615	41.02	1	BLUE
66226-016	16	1.500	38.10	1.790	45.47	1.715	43.56	1	BLUE
66226-017	17	1.600	40.64	1.890	48.01	1.815	46.10	1	BLUE
66226-018	18	1.700	43.18	1.990	50.55	1.915	48.64	1	BLUE
66226-019	19	1.800	45.72	2.090	53.09	2.015	51.18	1	BLUE
66226-020	20	1.900	48.26	2.190	55.63	2.115	53.72	1	BLUE
66226-021	21	2.000	50.80	2.290	58.17	2.215	56.26	1	BLUE
66226-022	22	2.100	53.34	2.390	60.71	2.315	58.80	1	BLUE
66226-023	23	2.200	55.88	2.490	63.25	2.415	61.34	1	BLUE
66226-024	24	2.300	58.42	2.590	65.79	2.515	63.88	1	BLUE
66226-025	25	2.400	60.96	2.690	68.33	2.615	66.42	1	BLUE
66226-026	26	2.500	63.50	2.790	70.87	2.715	68.96	1	BLUE
66226-027	27	2.600	66.04	2.890	73.41	2.815	71.50	1	BLUE
66226-028	28	2.700	68.58	2.990	75.95	2.915	74.04	1	BLUE
66226-029	29	2.800	71.12	3.090	78.49	3.015	76.58	1	BLUE
66226-030	30	2.900	73.66	3.190	81.03	3.115	79.12	1	BLUE
66226-031	31	3.000	76.20	3.290	83.57	3.215	81.66	1	BLUE
66226-032	32	3.100	78.74	3.390	86.11	3.315	84.20	1	BLUE

mat'l. code		surface ISO 1302 ✓	tolerance ISO 406 ISO 1101	projection 	product family CLINCHER
ltr	ecn	no	dr	date	title
X					CLINCHER™ PIN ASSEMBLY
					tolerances unless otherwise specified
					angles linear XXX.01/0.XXX.03 XXX.005/0.XXX.013 0°±2' XXXX.0028/0.XXX.0051
					INCH/MM scale 2:1
			dr	P.PARSONS	9/13/93
			engr	T. HANNA	9/13/93
			chr	T.BREWBAKER	9/13/93
			appd	T. HANNA	9/13/93
					dwg no 66226 sheet 2 of 4 size A3
					type Product Customer Drawing
sheet index	revision sheet				

PRODUCT NO.	NO. OF	DIM L	DIM L	DIM M	DIM M	DIM N	DIM N	PLATING	COLOR
NOTE 8	POSITION	ENGLISH	METRIC	ENGLISH	METRIC	ENGLISH	METRIC	CODE	
66226-033			U N A	S S I G	N E D				
66226-034	2	0.100	2.54	0.390	9.91	0.315	8.00	2	BLUE
66226-035	3	0.200	5.08	0.490	12.45	0.415	10.54	2	BLUE
66226-036	4	0.300	7.62	0.590	14.99	0.515	13.08	2	BLUE
66226-037	5	0.400	10.16	0.690	17.53	0.615	15.62	2	BLUE
66226-038	6	0.500	12.70	0.790	20.07	0.715	18.16	2	BLUE
66226-039	7	0.600	15.24	0.890	22.61	0.815	20.70	2	BLUE
66226-040	8	0.700	17.78	0.990	25.15	0.915	23.24	2	BLUE
66226-041	9	0.800	20.32	1.090	27.69	1.015	25.78	2	BLUE
66226-042	10	0.900	22.86	1.190	30.23	1.115	28.32	2	BLUE
66226-043	11	1.000	25.40	1.290	32.77	1.215	30.86	2	BLUE
66226-044	12	1.100	27.94	1.390	35.31	1.315	33.40	2	BLUE
66226-045	13	1.200	30.48	1.490	37.85	1.415	35.94	2	BLUE
66226-046	14	1.300	33.02	1.590	40.39	1.515	38.48	2	BLUE
66226-047	15	1.400	35.56	1.690	42.93	1.615	41.02	2	BLUE
66226-048	16	1.500	38.10	1.790	45.47	1.715	43.56	2	BLUE
66226-049	17	1.600	40.64	1.890	48.01	1.815	46.10	2	BLUE
66226-050	18	1.700	43.18	1.990	50.55	1.915	48.64	2	BLUE
66226-051	19	1.800	45.72	2.090	53.09	2.015	51.18	2	BLUE
66226-052	20	1.900	48.26	2.190	55.63	2.115	53.72	2	BLUE
66226-053	21	2.000	50.80	2.290	58.17	2.215	56.26	2	BLUE
66226-054	22	2.100	53.34	2.390	60.71	2.315	58.80	2	BLUE
66226-055	23	2.200	55.88	2.490	63.25	2.415	61.34	2	BLUE
66226-056	24	2.300	58.42	2.590	65.79	2.515	63.88	2	BLUE
66226-057	25	2.400	60.96	2.690	68.33	2.615	66.42	2	BLUE
66226-058	26	2.500	63.50	2.790	70.87	2.715	68.96	2	BLUE
66226-059	27	2.600	66.04	2.890	73.41	2.815	71.50	2	BLUE
66226-060	28	2.700	68.58	2.990	75.95	2.915	74.04	2	BLUE
66226-061	29	2.800	71.12	3.090	78.49	3.015	76.58	2	BLUE
66226-062	30	2.900	73.66	3.190	81.03	3.115	79.12	2	BLUE
66226-063	31	3.000	76.20	3.290	83.57	3.215	81.66	2	BLUE
66226-064	32	3.100	78.74	3.390	86.11	3.315	84.20	2	BLUE

mat'l. code		surface ISO 1302 ✓	tolerance ISO 406 ISO 1101	projection 	product family CLINCHER
ltr	ecn	no	dr	date	title
X					CLINCHER™ PIN ASSEMBLY
					INCH/MM
					scale 2:1
			dr	P. PARSONS	9/13/93
			enr	T. HANNA	9/13/93
			chr	T. BREWBAKER	9/13/93
			app	T. HANNA	9/13/93
sheet	revision				
index	sheet				
		dwg no		sheet	3 of 4
		66226		size	A3
		type Product Customer Drawing			

PRODUCT NO.	NO. OF	DIM L	DIM L	DIM M	DIM M	DIM N	DIM N	PLATING	POSITION NO.	TERMINAL NO.	COLOR
NOTE 8	POSITION	ENGLISH	METRIC	ENGLISH	METRIC	ENGLISH	METRIC	CODE	CLOSED (SEE NOTE 7)	ABSENT (SEE NOTE 7)	
66226-202	12	1.100	27.94	1.390	35.31	1.315	33.40	2	5	5	BLUE
66226-203	7	0.600	15.24	0.890	22.61	0.815	20.70	2	2	2	BLUE
66226-208	13	1.200	30.48	1.490	37.85	1.415	35.94	2	N/A	5	BLUE
66226-212	14	1.300	33.02	1.590	40.39	1.515	38.48	2	N/A	5,6,7,8,13	BLUE
66226-215	12	1.100	27.94	1.390	35.31	1.315	33.40	2	N/A	8	BLUE
66226-216	12	1.100	27.94	1.390	35.31	1.315	33.40	2	N/A	11	BLUE
66226-217	6	0.500	12.70	0.790	20.07	0.715	18.16	2	N/A	6	BLUE
66226-221	8	0.700	17.78	0.990	25.15	0.915	23.24	2	N/A	6	BLUE
66226-222	12	1.100	27.94	1.390	35.31	1.315	33.40	2	N/A	6	BLUE

NOTES :

- HOUSING MATERIAL : THERMOPLASTIC, FLAME RETARDANT PER UL94V-0. COLOR: SEE TABLE.
- TERMINAL MATERIAL : 1/2 HARD CU NI ALLOY, UNS-C72500.
- TERMINAL PLATING : SEE PART NO. TABULATION.
- SEE TA-372 FOR CRIMP HEIGHT.
- FOR CABLE AND CIRCUITRY INFO. SEE TA-264 & 371.
- LATCH SWINGS CLOSED AFTER TERMINATION MAINTAINING A MAX. OVER ALL HEIGHT OF .100/2.54.
- FIGURE SHOWS POSITION NO. 2 CLOSED. POSITION NUMBERS INITIATE FROM TRIANGULAR MARK END. SEE CHART FOR CLOSED AND EMPTY POSITION(S).
- ADD "LF" SUFFIX AT THE END OF PART NUMBER FOR LEAD FREE OPTION.
- THIS PRODUCT MEETS EUROPEAN UNION DIRECTIVES AND OTHER COUNTRY REGULATION AS DESCRIBED IN GS-22-008.
- THE PRODUCT IS NOT INTENDED TO BE EXPOSED TO A MANUFACTURING SOLDER PROCESS
- PLATING OPTIONS: MAY BE EITHER GOLD OR GXT PLATED AT MANUFACTURER'S OPTION.
- PRODUCT SPEC: BUS-12-061/062

PRODUCT NUMBER
66226-XXXLF

- LEAD FREE OPTION
NOTE 8,9
- NO OF POSITIONS
AND PLATING
- BASE PART NUMBER

NO.	TERMINAL PLATING
1	100u"/2.54u MIN. Sn (ALL OVER)
2	30u"/0.76u MIN Au or GXT IN AREA 1 (SEE SECT. Y-Y SH. 1) NOTE 11

mat'l. code		surface ISO 1302 ✓	tolerance ISO 406 ISO 1101	projection INCH/MM	product family CLINCHER
l	tr	ec	n	o	r
date		tolerances unless otherwise specified			title
X		angles	linear	INCH/MM	CLINCHER™ PIN ASSEMBLY
		0°±2'		scale 2:1	
dr	P. PARSONS	9/13/93			
en	T. HANNA	9/13/93			
chr	T. BREWBAKER	9/13/93			
app	T. HANNA	9/13/93	dwg no 66226 sheet 4 of 4 size A3		
type Product Customer Drawing					
sheet index	revision sheet				



Компания «ЭлектроПласт» предлагает заключение долгосрочных отношений при поставках импортных электронных компонентов на взаимовыгодных условиях!

Наши преимущества:

- Оперативные поставки широкого спектра электронных компонентов отечественного и импортного производства напрямую от производителей и с крупнейших мировых складов;
- Поставка более 17-ти миллионов наименований электронных компонентов;
- Поставка сложных, дефицитных, либо снятых с производства позиций;
- Оперативные сроки поставки под заказ (от 5 рабочих дней);
- Экспресс доставка в любую точку России;
- Техническая поддержка проекта, помощь в подборе аналогов, поставка прототипов;
- Система менеджмента качества сертифицирована по Международному стандарту ISO 9001;
- Лицензия ФСБ на осуществление работ с использованием сведений, составляющих государственную тайну;
- Поставка специализированных компонентов (Xilinx, Altera, Analog Devices, Intersil, Interpoint, Microsemi, Aeroflex, Peregrine, Syfer, Eurofarad, Texas Instrument, Miteq, Cobham, E2V, MA-COM, Hittite, Mini-Circuits, General Dynamics и др.);

Помимо этого, одним из направлений компании «ЭлектроПласт» является направление «Источники питания». Мы предлагаем Вам помощь Конструкторского отдела:

- Подбор оптимального решения, техническое обоснование при выборе компонента;
- Подбор аналогов;
- Консультации по применению компонента;
- Поставка образцов и прототипов;
- Техническая поддержка проекта;
- Защита от снятия компонента с производства.



Как с нами связаться

Телефон: 8 (812) 309 58 32 (многоканальный)

Факс: 8 (812) 320-02-42

Электронная почта: org@eplast1.ru

Адрес: 198099, г. Санкт-Петербург, ул. Калинина, дом 2, корпус 4, литера А.