

MAX6070/MAX6071

Low-Noise, High-Precision Series Voltage References

General Description

The MAX6070/MAX6071 offer a very low noise and low-drift voltage reference in a small 6-pin SOT23 package. These devices provide a $1/f$ noise voltage of only $4.8\mu\text{V}_{\text{P-P}}$ at an output voltage of 2.5V, with a temperature drift of $6\text{ppm}/^\circ\text{C}$ (max). The MAX6070/MAX6071 consume $150\mu\text{A}$ of supply current and can sink and source up to 10mA of load current. The low-drift and low-noise specifications enable enhanced system accuracy, making these devices ideal for high precision industrial applications. The MAX6070 offers a noise filter option for wide-band applications.

The devices are available in a 6-pin SOT23 package and specified over the extended industrial temperature range of -40°C to $+125^\circ\text{C}$.

Applications

- High-Accuracy Industrial and Process Control
- Precision Instrumentation
- High-Resolution ADCs and DACs
- Precision Current Sources

Benefits and Features

- 6-Pin SOT23 Package Reduces System Board Space
- Stable Performance Over Temperature and Time Improves System Accuracy
 - High $\pm 0.04\%$ Initial Accuracy
 - Low $1.5\text{ppm}/^\circ\text{C}$ (typ), $6\text{ppm}/^\circ\text{C}$ (max) Temperature Drift
 - Low $4.8\mu\text{V}_{\text{P-P}}$ Noise (0.1Hz to 10Hz) at 2.5V
 - Low 200mV Dropout Voltage
 - High 85dB Ripple Rejection
- Low $150\mu\text{A}$ Supply Current Reduces Power Consumption
- Filter Option Lowers High-Frequency Noise
- Output Options: 1.25V, 1.8V, 2.048V, 2.5V, 3.0V, 3.3V, 4.096V, and 5.0V Cover Common Voltage Levels for a Wide Variety of Applications

Ordering Information and Selector Guide appears at end of data sheet.

Typical Operating Circuits

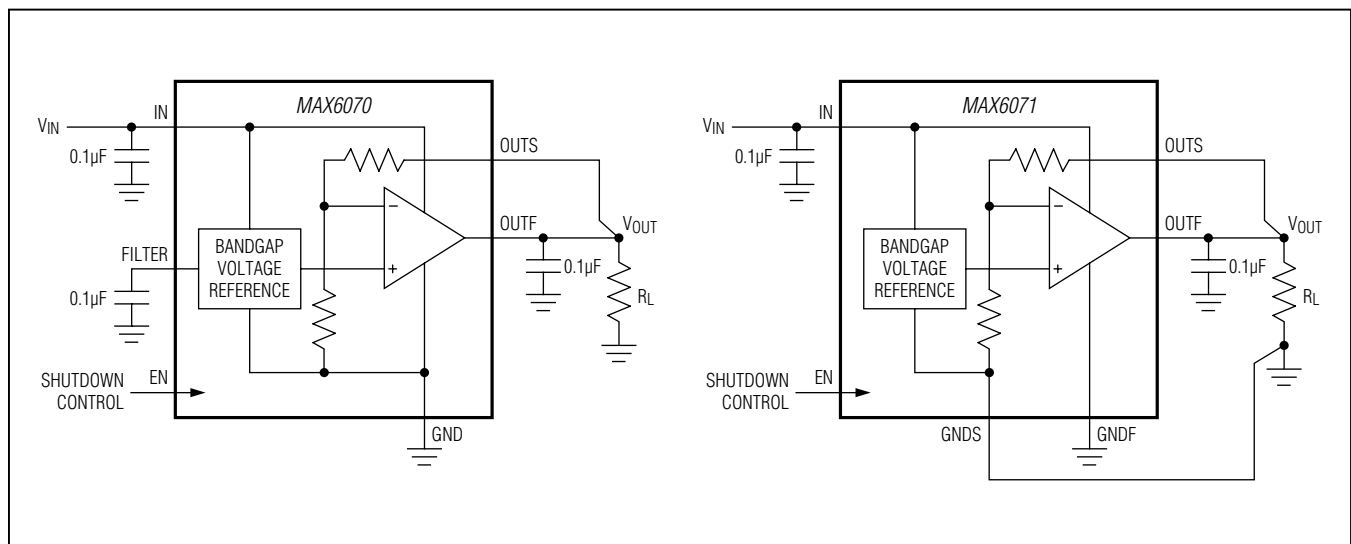

Absolute Maximum Ratings

| | | | |
|-------------------------------|---|--|-----------------------------------|
| OUTF to GNDS, GNDF, GND..... | -0.3V to the lower of ($V_{IN} + 0.3V$), +6V | Continuous Power Dissipation ($T_A = +70^\circ C$) SOT23 (derate 4.3mW/ $^\circ C$ above +70 $^\circ C$) | 347.8mW |
| OUTS to GNDS, GNDF, GND | -0.3V to +6V | Operating Temperature Range | -40 $^\circ C$ to +125 $^\circ C$ |
| IN to GNDS, GNDF, GND | -0.3V to +6V | Junction Temperature | +150 $^\circ C$ |
| EN to GNDS, GNDF, GND | -0.3V to +6V | Storage Temperature Range..... | -65 $^\circ C$ to +150 $^\circ C$ |
| FILTER to GND..... | -0.3V to the lower of ($V_{IN} + 0.3V$), +6V | Soldering Temperature (reflow) | +260 $^\circ C$ |
| GNDS to GNDF | -0.3V to +0.3V | Lead Temperature (soldering, 10s) | +300 $^\circ C$ |

Stresses beyond those listed under "Absolute Maximum Ratings" may cause permanent damage to the device. These are stress ratings only, and functional operation of the device at these or any other conditions beyond those indicated in the operational sections of the specifications is not implied. Exposure to absolute maximum rating conditions for extended periods may affect device reliability.

Package Thermal Characteristics (Note 1)

| | | | | |
|-------|---|------------------|--|-----------------|
| SOT23 | Junction-to-Ambient Thermal Resistance (θ_{JA})..... | 230 $^\circ C/W$ | Junction-to-Case Thermal Resistance (θ_{JC})..... | 76 $^\circ C/W$ |
|-------|---|------------------|--|-----------------|

Note 1: Package thermal resistances were obtained using the method described in JEDEC specification JESD51-7, using a four-layer board. For detailed information on package thermal considerations, refer to www.maximintegrated.com/thermal-tutorial.

Electrical Characteristics—MAX607__AUT12 ($V_{OUT} = 1.250V$)

($V_{IN} = +5.0V$, $I_{OUT} = 0mA$, $C_{OUT} = 0.1\mu F$, $T_A = -40^\circ C$ to +125 $^\circ C$, unless otherwise noted. Typical values are at $T_A = +25^\circ C$.) (Note 2)

| PARAMETER | SYMBOL | CONDITIONS | MIN | TYP | MAX | UNITS | |
|---|--------------------|--|-------|------------------------------|-------|--------------------|-----------|
| OUTPUT | | | | | | | |
| Output Voltage Accuracy | | MAX6070A/MAX6071A, $T_A = +25^\circ C$ | -0.04 | | +0.04 | % | |
| | | MAX6070B/MAX6071B, $T_A = +25^\circ C$ | -0.08 | | +0.08 | | |
| Output Voltage Temperature Drift (Note 3) | TCV _{OUT} | MAX6070A/MAX6071A | | 1.5 | 6 | ppm/ $^\circ C$ | |
| | | MAX6070B/MAX6071B | | 2.0 | 8 | | |
| Line Regulation | | Over specified V_{IN} range | | $T_A = +25^\circ C$ | 13 | 100 | $\mu V/V$ |
| | | | | $T_A = T_{MIN}$ to T_{MAX} | | 125 | |
| Load Regulation | | 0mA < I_{OUT} < 10mA, sink | | 70 | 150 | $\mu V/mA$ | |
| | | 0mA < I_{OUT} < 10mA, source | | 100 | 150 | | |
| Output Current | I_{OUT} | | -10 | | +10 | mA | |
| Short-Circuit Current | I_{SC} | Sourcing to ground | | 25 | | mA | |
| | | Sinking from V_{IN} | | 25 | | | |
| Long-Term Stability | | 1000 hours at $T_A = +25^\circ C$ | | 35 | | ppm | |
| Thermal Hysteresis | | (Note 5) | | 85 | | ppm | |
| DYNAMIC CHARACTERISTICS | | | | | | | |
| Noise Voltage | e_{OUT} | 1/f noise, 0.1Hz to 10Hz, $C_{OUT} = 0.1\mu F$ | | 3.6 | | μV_{P-P} | |
| | | MAX6071 thermal noise, 10Hz to 10kHz, $C_{OUT} = 0.1\mu F$ | | 5.0 | | μV_{RMS} | |
| | | MAX6070 thermal noise, 10Hz to 10kHz, $C_{OUT} = 0.1\mu F$, $C_{FILTER} = 0.1\mu F$ | | 2.5 | | | |
| Ripple Rejection | | Frequency = 60Hz | | 100 | | dB | |

Electrical Characteristics—MAX607__AUT12 (V_{OUT} = 1.250V) (continued)(V_{IN} = +5.0V, I_{OUT} = 0mA, C_{OUT} = 0.1μF, T_A = -40°C to +125°C, unless otherwise noted. Typical values are at T_A = +25°C.) (Note 2)

| PARAMETER | SYMBOL | CONDITIONS | MIN | TYP | MAX | UNITS |
|---------------------------------|-----------------|---|---|-----|-----------------------|-------|
| Turn-On Settling Time | t _R | Settling to 0.01%, C _{OUT} = 0.1μF | MAX6070, C _{FILTER} = 0.1μF | 6 | | ms |
| | | | MAX6071 | 20 | | μs |
| Enable Settling Time | t _{EN} | Settling to 0.01%, C _{OUT} = 0.1μF | MAX6070, C _{FILTER} = 0.1μF | 6 | | ms |
| | | | MAX6071 | 60 | | μs |
| Capacitive-Load Stability Range | | I _{OUT} ≤ 10mA | 0.1 | | 10 | μF |
| INPUT | | | | | | |
| Supply Voltage | V _{IN} | Guaranteed by line regulation | 2.7 | | 5.5 | V |
| Quiescent Supply Current | I _{IN} | T _A = +25°C | | 130 | 200 | μA |
| | | T _A = T _{MIN} to T _{MAX} | | | 260 | |
| Shutdown Supply Current | I _{SD} | | | | 6 | μA |
| ENABLE | | | | | | |
| Enable Input Current | I _{EN} | | -1 | | +1 | μA |
| Enable Logic-High | V _{IH} | | 0.7 × V _{IN} | | | V |
| Enable Logic-Low | V _{IL} | | | | 0.3 × V _{IN} | |

Electrical Characteristics—MAX607__AUT18 (V_{OUT} = 1.800V)(V_{IN} = +5.0V, I_{OUT} = 0mA, C_{OUT} = 0.1μF, T_A = -40°C to +125°C, unless otherwise noted. Typical values are at T_A = +25°C.) (Note 2)

| PARAMETER | SYMBOL | CONDITIONS | MIN | TYP | MAX | UNITS |
|--|--------------------|---|---|-----|-------|--------|
| OUTPUT | | | | | | |
| Output Voltage Accuracy | | MAX6070A/MAX6071A, T _A = +25°C | -0.04 | | +0.04 | % |
| | | MAX6070B/MAX6071B, T _A = +25°C | -0.08 | | +0.08 | |
| Output Voltage Temperature Drift(Note 3) | TCV _{OUT} | MAX6070A/MAX6071A | | 1.5 | 6 | ppm/°C |
| | | MAX6070B/MAX6071B | | 2.0 | 8 | |
| Line Regulation | | Over specified V _{IN} range | T _A = +25°C | 35 | 150 | μV/V |
| | | | T _A = T _{MIN} to T _{MAX} | | 200 | |
| Load Regulation | | 0mA < I _{OUT} < 10mA, sink | | 120 | 200 | μV/mA |
| | | 0mA < I _{OUT} < 10mA, source | | 120 | 200 | |
| Output Current | I _{OUT} | | -10 | | +10 | mA |
| Short-Circuit Current | I _{SC} | Sourcing to ground | | 25 | | mA |
| | | Sinking from V _{IN} | | 25 | | |
| Long-Term Stability | | 1000 hours at T _A = +25°C | | 35 | | ppm |
| Thermal Hysteresis | | (Note 5) | | 85 | | ppm |

Electrical Characteristics—MAX607__AUT18 (V_{OUT} = 1.800V)(V_{IN} = +5.0V, I_{OUT} = 0mA, C_{OUT} = 0.1μF, T_A = -40°C to +125°C, unless otherwise noted. Typical values are at T_A = +25°C.) (Note 2)

| PARAMETER | SYMBOL | CONDITIONS | | MIN | TYP | MAX | UNITS |
|---------------------------------|------------------|---|--|-----------------------|-----|-----|-------------------|
| DYNAMIC CHARACTERISTICS | | | | | | | |
| Noise Voltage | e _{OUT} | 1/f noise, 0.1Hz to 10Hz, C _{OUT} = 0.1μF | | | 6 | | μV _{P-P} |
| | | MAX6071 thermal noise, 10Hz to 10kHz C _{OUT} = 0.1μF | | | 7 | | μV _{RMS} |
| | | MAX6070 thermal noise, 10Hz to 10kHz C _{OUT} = 0.1μF, C _{FILTER} = 0.1μF | | | 5 | | |
| Ripple Rejection | | Frequency = 60Hz | | | 89 | | dB |
| Turn-On Settling Time | t _R | Settling to 0.01% C _{OUT} = 0.1μF | MAX6070 C _{FILTER} = 0.1μF | | 6 | | ms |
| | | | MAX6071 | | 32 | | μs |
| Enable Settling Time | t _{EN} | Settling to 0.01% C _{OUT} = 0.1μF | MAX6070 C _{FILTER} = 0.1μF | | 6 | | ms |
| | | | MAX6071 | | 60 | | μs |
| Capacitive-Load Stability Range | | I _{OUT} ≤ 10mA | | 0.1 | | 10 | μF |
| INPUT | | | | | | | |
| Supply Voltage | V _{IN} | Guaranteed by line regulation | | 2.7 | | 5.5 | V |
| Quiescent Supply Current | I _{IN} | T _A = +25°C | | | 130 | 200 | μA |
| | | T _A = T _{MIN} to T _{MAX} | | | | 260 | |
| Shutdown Supply Current | I _{SD} | | | | | 6 | μA |
| ENABLE | | | | | | | |
| Enable Input Current | I _{EN} | | | -1 | | 1 | μA |
| Enable Logic-High | V _{IH} | | | 0.7 x V _{IN} | | | V |
| Enable Logic-Low | V _{IL} | | | 0.3 x V _{IN} | | | |

Electrical Characteristics—MAX607__AUT21 (V_{OUT} = 2.048V)(V_{IN} = +5.0V, I_{OUT} = 0mA, C_{OUT} = 0.1μF, T_A = -40°C to +125°C, unless otherwise noted. Typical values are at T_A = +25°C.) (Note 2)

| PARAMETER | SYMBOL | CONDITIONS | | MIN | TYP | MAX | UNITS |
|---|--------------------|---|---|-------|-----|-------|--------|
| OUTPUT | | | | | | | |
| Output Voltage Accuracy | | MAX6070A/MAX6071A, T _A = +25°C | | -0.04 | | +0.04 | % |
| | | MAX6070B/MAX6071B, T _A = +25°C | | -0.08 | | +0.08 | |
| Output Voltage Temperature Drift (Note 3) | TCV _{OUT} | MAX6070A/MAX6071A | | | 1.5 | 6 | ppm/°C |
| | | MAX6070B/MAX6071B | | | 2.0 | 8 | |
| Line Regulation | | Over specified V _{IN} range | T _A = +25°C | | 50 | 180 | μV/V |
| | | | T _A = T _{MIN} to T _{MAX} | | | 225 | |

Electrical Characteristics—MAX607__AUT21 (V_{OUT} = 2.048V) (continued)(V_{IN} = +5.0V, I_{OUT} = 0mA, C_{OUT} = 0.1μF, T_A = -40°C to +125°C, unless otherwise noted. Typical values are at T_A = +25°C.) (Note 2)

| PARAMETER | SYMBOL | CONDITIONS | MIN | TYP | MAX | UNITS |
|---------------------------------|------------------|---|--|-----|-----|-------------------|
| Load Regulation | | 0mA < I _{OUT} < 10mA, sink | | 135 | 225 | μV/mA |
| | | 0mA < I _{OUT} < 10mA, source | | 135 | 225 | |
| Output Current | I _{OUT} | | -10 | | +10 | mA |
| Short-Circuit Current | I _{SC} | Sourcing to ground | | 25 | | mA |
| | | Sinking from V _{IN} | | 25 | | |
| Long-Term Stability | | 1000 hours at T _A = +25°C | | 35 | | ppm |
| Thermal Hysteresis | | (Note 5) | | 85 | | ppm |
| DYNAMIC CHARACTERISTICS | | | | | | |
| Noise Voltage | e _{OUT} | 1/f noise, 0.1Hz to 10Hz, C _{OUT} = 0.1μF | | 6.4 | | μV _{P-P} |
| | | MAX6071 thermal noise, 10Hz to 10kHz C _{OUT} = 0.1μF | | 8.6 | | μV _{RMS} |
| | | MAX6070 thermal noise, 10Hz to 10kHz C _{OUT} = 0.1μF, C _{FILTER} = 0.1μF | | 6.3 | | |
| Ripple Rejection | | Frequency = 60Hz | | 86 | | dB |
| Turn-On Settling Time | t _R | Settling to 0.01% C _{OUT} = 0.1μF | MAX6070 C _{FILTER} = 0.1μF | 6.2 | | ms |
| | | | MAX6071 | | 25 | |
| Enable Settling Time | t _{EN} | Settling to 0.01% C _{OUT} = 0.1μF | MAX6070 C _{FILTER} = 0.1μF | 6.2 | | ms |
| | | | MAX6071 | | 65 | |
| Capacitive-Load Stability Range | | I _{OUT} ≤ 10mA | 0.1 | | 10 | μF |
| INPUT | | | | | | |
| Supply Voltage | V _{IN} | Guaranteed by line regulation | 2.7 | | 5.5 | V |
| Quiescent Supply Current | I _{IN} | T _A = +25°C | | 130 | 200 | μA |
| | | T _A = T _{MIN} to T _{MAX} | | | 260 | |
| Shutdown Supply Current | I _{SD} | | | | 6 | μA |
| ENABLE | | | | | | |
| Enable Input Current | I _{EN} | | -1 | | +1 | μA |
| Enable Logic-High | V _{IH} | | 0.7 x V _{IN} | | | V |
| Enable Logic-Low | V _{IL} | | 0.3 x V _{IN} | | | |

Electrical Characteristics—MAX607__AUT25 (V_{OUT} = 2.500V)(V_{IN} = +5.0V, I_{OUT} = 0mA, C_{OUT} = 0.1μF, T_A = -40°C to +125°C, unless otherwise noted. Typical values are at T_A = +25°C.) (Note 2)

| PARAMETER | SYMBOL | CONDITIONS | MIN | TYP | MAX | UNITS |
|---|--------------------|---|--------------------------------------|---|-------|-------------------|
| OUTPUT | | | | | | |
| Output Voltage Accuracy | | MAX6070A/MAX6071A, T _A = +25°C | -0.04 | | +0.04 | % |
| | | MAX6070B/MAX6071B, T _A = +25°C | -0.08 | | +0.08 | |
| Output Voltage Temperature Drift (Note 3) | TCV _{OUT} | MAX6070A/MAX6071A | | 1.5 | 6 | ppm/°C |
| | | MAX6070B/MAX6071B | | 2.0 | 8 | |
| Line Regulation | | Over specified V _{IN} range | T _A = +25°C | 60 | 145 | μV/V |
| | | | | T _A = T _{MIN} to T _{MAX} | | |
| Load Regulation | | 0mA < I _{OUT} < 10mA, sink | | 80 | 140 | μV/mA |
| | | 0mA < I _{OUT} < 10mA, source | | 75 | 125 | |
| Dropout Voltage | | I _{OUT} = 10mA, T _A = T _{MIN} to T _{MAX} (Note 4) | | 110 | 230 | mV |
| Output Current | I _{OUT} | | -10 | | +10 | mA |
| Short-Circuit Current | I _{SC} | Sourcing to ground | | 25 | | mA |
| | | Sinking from V _{IN} | | 25 | | |
| Long-Term Stability | | 1000 hours at T _A = +25°C | | 40 | | ppm |
| Thermal Hysteresis | | (Note 5) | | 85 | | ppm |
| DYNAMIC CHARACTERISTICS | | | | | | |
| Noise Voltage | e _{OUT} | 1/f noise, 0.1Hz to 10Hz, C _{OUT} = 0.1μF | | 4.8 | | μV _{P-P} |
| | | MAX6071 thermal noise, 10Hz to 10kHz, C _{OUT} = 0.1μF | | 6 | | μV _{RMS} |
| | | MAX6070 thermal noise, 10Hz to 10kHz, C _{OUT} = 0.1μF, C _{FILTER} = 0.1μF | | 3 | | |
| Noise Spectral Density | | MAX6071 thermal noise, f = 1kHz, C _{OUT} = 0.1μF | | 60 | | nV/√Hz |
| | | MAX6070 thermal noise, f = 1kHz, C _{OUT} = 0.1μF, C _{FILTER} = 0.1μF | | 30 | | |
| Ripple Rejection | | Frequency = 60Hz | | 84 | | dB |
| Turn-On Settling Time | t _R | Settling to 0.01%, C _{OUT} = 0.1μF | MAX6070, C _{FILTER} = 0.1μF | 10 | | ms |
| | | | MAX6071 | 30 | | μs |
| Enable Settling Time | t _{EN} | Settling to 0.01%, C _{OUT} = 0.1μF | MAX6070, C _{FILTER} = 0.1μF | 10 | | ms |
| | | | MAX6071 | 75 | | μs |
| Capacitive-Load Stability Range | | I _{OUT} ≤ 10mA | 0.1 | | 10 | μF |

Electrical Characteristics—MAX607__AUT25 (V_{OUT} = 2.500V) (continued)(V_{IN} = +5.0V, I_{OUT} = 0mA, C_{OUT} = 0.1μF, T_A = -40°C to +125°C, unless otherwise noted. Typical values are at T_A = +25°C.) (Note 2)

| PARAMETER | SYMBOL | CONDITIONS | MIN | TYP | MAX | UNITS |
|--------------------------|-----------------|---|-----------------------|-----|-----------------------|-------|
| INPUT | | | | | | |
| Supply Voltage | V _{IN} | Guaranteed by line regulation | 2.8 | | 5.5 | V |
| Quiescent Supply Current | I _{IN} | T _A = +25°C | | 150 | 235 | μA |
| | | T _A = T _{MIN} to T _{MAX} | | | 300 | |
| Shutdown Supply Current | I _{SD} | | | 0.6 | 6 | μA |
| ENABLE/SHUTDOWN | | | | | | |
| Enable Input Current | I _{EN} | | -1 | | +1 | μA |
| Enable Logic-High | V _{IH} | | 0.7 × V _{IN} | | | V |
| Enable Logic-Low | V _{IL} | | | | 0.3 × V _{IN} | |

Electrical Characteristics—MAX607__AUT30 (V_{OUT} = 3.000V)(V_{IN} = +5.0V, I_{OUT} = 0mA, C_{OUT} = 0.1μF, T_A = -40°C to +125°C, unless otherwise noted. Typical values are at T_A = +25°C.) (Note 2)

| PARAMETER | SYMBOL | CONDITIONS | MIN | TYP | MAX | UNITS | |
|---|--------------------|---|-------|---|-------|-------------------|------|
| OUTPUT | | | | | | | |
| Output Voltage Accuracy | | MAX6070A/MAX6071A, T _A = +25°C | -0.04 | | +0.04 | % | |
| | | MAX6070B/MAX6071B, T _A = +25°C | -0.08 | | +0.08 | | |
| Output Voltage Temperature Drift (Note 3) | TCV _{OUT} | MAX6070A/MAX6071A | | 1.5 | 6 | ppm/°C | |
| | | MAX6070B/MAX6071B | | 2.0 | 8 | | |
| Line Regulation | | Over specified V _{IN} range | | T _A = +25°C | 90 | 200 | μV/V |
| | | | | T _A = T _{MIN} to T _{MAX} | | 260 | |
| Load Regulation | | 0mA < I _{OUT} < 10mA, sink | | 90 | 170 | μV/mA | |
| | | 0mA < I _{OUT} < 10mA, source | | 90 | 150 | | |
| Dropout Voltage | | I _{OUT} = 10mA, T _A = T _{MIN} to T _{MAX} (Note 4) | | 80 | 150 | mV | |
| Output Current | I _{OUT} | | | -10 | +10 | mA | |
| Short-Circuit Current | I _{SC} | Sourcing to ground | | 25 | | mA | |
| | | Sinking from V _{IN} | | 25 | | | |
| Long-Term Stability | | 1000 hours at T _A = +25°C | | 40 | | ppm | |
| Thermal Hysteresis | | (Note 5) | | 85 | | ppm | |
| DYNAMIC CHARACTERISTICS | | | | | | | |
| Noise Voltage | e _{OUT} | 1/f noise, 0.1Hz to 10Hz, C _{OUT} = 0.1μF | | 4.6 | | μV _{P-P} | |
| | | MAX6071 thermal noise, 10Hz to 10kHz, C _{OUT} = 0.1μF | | 7.8 | | μV _{RMS} | |
| | | MAX6070 thermal noise, 10Hz to 10kHz, C _{OUT} = 0.1μF, C _{FILTER} = 0.1μF | | 5.0 | | | |
| Ripple Rejection | | Frequency = 60Hz | | 80 | | dB | |

Electrical Characteristics—MAX607__AUT30 (V_{OUT} = 3.000V) (continued)(V_{IN} = +5.0V, I_{OUT} = 0mA, C_{OUT} = 0.1μF, T_A = -40°C to +125°C, unless otherwise noted. Typical values are at T_A = +25°C.) (Note 2)

| PARAMETER | SYMBOL | CONDITIONS | MIN | TYP | MAX | UNITS |
|---------------------------------|-----------------|---|---|-----|-----------------------|-------|
| Turn-On Settling Time | t _R | Settling to 0.01%, C _{OUT} = 0.1μF | MAX6070, C _{FILTER} = 0.1μF | 9.7 | | ms |
| | | | MAX6071 | 40 | | μs |
| Enable Settling Time | t _{EN} | Settling to 0.01%, C _{OUT} = 0.1μF | MAX6070, C _{FILTER} = 0.1μF | 9.7 | | ms |
| | | | MAX6071 | 75 | | μs |
| Capacitive-Load Stability Range | | I _{OUT} ≤ 10mA | 0.1 | | 10 | μF |
| INPUT | | | | | | |
| Supply Voltage | V _{IN} | Guaranteed by line regulation | 3.2 | | 5.5 | V |
| Quiescent Supply Current | I _{IN} | T _A = +25°C | | 150 | 235 | μA |
| | | T _A = T _{MIN} to T _{MAX} | | | 300 | |
| Shutdown Supply Current | I _{SD} | | | 0.6 | 6 | μA |
| ENABLE/SHUTDOWN | | | | | | |
| Enable Input Current | I _{EN} | | -1 | | +1 | μA |
| Enable Logic-High | V _{IH} | | 0.7 x V _{IN} | | | V |
| Enable Logic-Low | V _{IL} | | | | 0.3 x V _{IN} | |

Electrical Characteristics—MAX607__AUT33 (V_{OUT} = 3.300V)(V_{IN} = +5.0V, I_{OUT} = 0mA, C_{OUT} = 0.1μF, T_A = -40°C to +125°C, unless otherwise noted. Typical values are at T_A = +25°C.) (Note 2)

| PARAMETER | SYMBOL | CONDITIONS | MIN | TYP | MAX | UNITS |
|---|--------------------|--|---|-----|-------|--------|
| OUTPUT | | | | | | |
| Output Voltage Accuracy | | MAX6070A/MAX6071A, T _A = +25°C | -0.04 | | +0.04 | % |
| | | MAX6070B/MAX6071B, T _A = +25°C | -0.08 | | +0.08 | |
| Output Voltage Temperature Drift (Note 3) | TCV _{OUT} | MAX6070A/MAX6071A | | 1.5 | 6 | ppm/°C |
| | | MAX6070B/MAX6071B | | 2.0 | 8 | |
| Line Regulation | | Over specified V _{IN} range | T _A = +25°C | 90 | 220 | μV/V |
| | | | T _A = T _{MIN} to T _{MAX} | | | |
| Load Regulation | | 0mA < I _{OUT} < 10mA, sink | | 100 | 190 | μV/mA |
| | | 0mA < I _{OUT} < 10mA, source | | 100 | 165 | |
| Dropout Voltage | | I _{OUT} = 10mA, T _A = T _{MIN} to T _{MAX} (Note 4) | | 65 | 150 | mV |
| Output Current | I _{OUT} | | -10 | | 10 | mA |
| Short-Circuit Current | I _{SC} | Sourcing to ground | | 25 | | mA |
| | | Sinking from V _{IN} | | 25 | | |
| Long-Term Stability | | 1000 hours at T _A = +25°C | | 40 | | ppm |
| Thermal Hysteresis | | (Note 5) | | 85 | | ppm |

Electrical Characteristics—MAX607__AUT33 (V_{OUT} = 3.300V) (continued)(V_{IN} = +5.0V, I_{OUT} = 0mA, C_{OUT} = 0.1μF, T_A = -40°C to +125°C, unless otherwise noted. Typical values are at T_A = +25°C.) (Note 2)

| PARAMETER | SYMBOL | CONDITIONS | MIN | TYP | MAX | UNITS |
|---------------------------------|------------------|---|--------------------------------------|-----|-----|-------------------|
| DYNAMIC CHARACTERISTICS | | | | | | |
| Noise Voltage | e _{OUT} | 1/f noise, 0.1Hz to 10Hz, C _{OUT} = 0.1μF | | 10 | | μV _{P-P} |
| | | MAX6071 thermal noise, 10Hz to 10kHz, C _{OUT} = 0.1μF | | 9 | | μV _{RMS} |
| | | MAX6070 thermal noise, 10Hz to 10kHz, C _{OUT} = 0.1μF, C _{FILTER} = 0.1μF | | 6 | | |
| Ripple Rejection | | Frequency = 60Hz | | 78 | | dB |
| Turn-On Settling Time | t _R | Settling to 0.01%, C _{OUT} = 0.1μF | MAX6070, C _{FILTER} = 0.1μF | 10 | | ms |
| | | | MAX6071 | 42 | | μs |
| Enable Settling Time | t _{EN} | Settling to 0.01%, C _{OUT} = 0.1μF | MAX6070, C _{FILTER} = 0.1μF | 10 | | ms |
| | | | MAX6071 | 75 | | μs |
| Capacitive-Load Stability Range | | I _{OUT} ≤ 10mA | 0.1 | | 10 | μF |
| INPUT | | | | | | |
| Supply Voltage | V _{IN} | Guaranteed by line regulation | 3.5 | | 5.5 | V |
| Quiescent Supply Current | I _{IN} | T _A = +25°C | | 160 | 240 | μA |
| | | T _A = T _{MIN} to T _{MAX} | | | 330 | |
| Shutdown Supply Current | I _{SD} | | | 0.6 | 6 | μA |
| ENABLE/SHUTDOWN | | | | | | |
| Enable Input Current | I _{EN} | | -1 | | 1 | μA |
| Enable Logic-High | V _{IH} | | 0.7 x V _{IN} | | | V |
| Enable Logic-Low | V _{IL} | | 0.3 x V _{IN} | | | |

Electrical Characteristics—MAX607__AUT41 (V_{OUT} = 4.096V)(V_{IN} = +5.0V, I_{OUT} = 0mA, C_{OUT} = 0.1μF, T_A = -40°C to +125°C, unless otherwise noted. Typical values are at T_A = +25°C.) (Note 2)

| PARAMETER | SYMBOL | CONDITIONS | MIN | TYP | MAX | UNITS |
|---|--------------------|---|---|-----|-------|------------|
| OUTPUT | | | | | | |
| Output Voltage Accuracy | | MAX6070A/MAX6071A, T _A = +25°C | -0.04 | | +0.04 | % |
| | | MAX6070B/MAX6071B, T _A = +25°C | -0.08 | | +0.08 | |
| Output Voltage Temperature Drift (Note 3) | TCV _{OUT} | MAX6070A/MAX6071A | | 1.5 | 6 | ppm/ °C |
| | | MAX6070B/MAX6071B | | 2.0 | 8 | |
| Line Regulation | | Over specified V _{IN} range | T _A = +25°C | 100 | 250 | μV/V |
| | | | T _A = T _{MIN} to T _{MAX} | | | |

Electrical Characteristics—MAX607__AUT41 (V_{OUT} = 4.096V) (continued)(V_{IN} = +5.0V, I_{OUT} = 0mA, C_{OUT} = 0.1μF, T_A = -40°C to +125°C, unless otherwise noted. Typical values are at T_A = +25°C.) (Note 2)

| PARAMETER | SYMBOL | CONDITIONS | MIN | TYP | MAX | UNITS |
|---------------------------------|------------------|---|---|-----|-----|-------------------|
| Load Regulation | | 0mA < I _{OUT} < 10mA, sink | | 125 | 225 | μV/mA |
| | | 0mA < I _{OUT} < 10mA, source | | 135 | 225 | |
| Dropout Voltage | | I _{OUT} = 10mA, T _A = T _{MIN} to T _{MAX} (Note 4) | | 75 | 150 | mV |
| Output Current | I _{OUT} | | -10 | | +10 | mA |
| Short-Circuit Current | I _{SC} | Sourcing to ground | | 25 | | mA |
| | | Sinking from V _{IN} | | 25 | | |
| Long-Term Stability | | 1000 hours at T _A = +25°C | | 35 | | ppm |
| Thermal Hysteresis | | (Note 5) | | 85 | | ppm |
| DYNAMIC CHARACTERISTICS | | | | | | |
| Noise Voltage | e _{OUT} | 1/f noise, 0.1Hz to 10Hz, C _{OUT} = 0.1μF | | 9.6 | | μV _{P-P} |
| | | MAX6071 thermal noise, 10Hz to 10kHz, C _{OUT} = 0.1μF | | 12 | | μV _{RMS} |
| | | MAX6070 thermal noise, 10Hz to 10kHz, C _{OUT} = 0.1μF, C _{FILTER} = 0.1μF | | 9 | | |
| Ripple Rejection | | Frequency = 60Hz | | 80 | | dB |
| Turn-On Settling Time | t _R | Settling to 0.01%, C _{OUT} = 0.1μF | MAX6070, C _{FILTER} = 0.1μF | 10 | | ms |
| | | | MAX6071 | 40 | | μs |
| Enable Settling Time | t _{EN} | Settling to 0.01%, C _{OUT} = 0.1μF | MAX6070, C _{FILTER} = 0.1μF | 10 | | ms |
| | | | MAX6071 | 85 | | μs |
| Capacitive-Load Stability Range | | I _{OUT} ≤ 10mA | 0.1 | | 10 | μF |
| INPUT | | | | | | |
| Supply Voltage | V _{IN} | Guaranteed by line regulation | 4.3 | | 5.5 | V |
| Quiescent Supply Current | I _{IN} | T _A = +25°C | | 150 | 235 | μA |
| | | T _A = T _{MIN} to T _{MAX} | | | 350 | |
| Shutdown Supply Current | I _{SD} | | | | 6 | μA |
| ENABLE | | | | | | |
| Enable Input Current | I _{EN} | | -1 | | +1 | μA |
| Enable Logic-High | V _{IH} | | 0.7 × V _{IN} | | | V |
| Enable Logic-Low | V _{IL} | | 0.3 × V _{IN} | | | |

Electrical Characteristics—MAX607__AUT50 (V_{OUT} = 5.000V)(V_{IN} = +5.5V, I_{OUT} = 0mA, C_{OUT} = 0.1μF, T_A = -40°C to +125°C, unless otherwise noted. Typical values are at T_A = +25°C.) (Note 2)

| PARAMETER | SYMBOL | CONDITIONS | | MIN | TYP | MAX | UNITS |
|---|--------------------|---|---|-------|-----|-------|-------------------|
| OUTPUT | | | | | | | |
| Output Voltage Accuracy | | MAX6070A/MAX6071A, T _A = +25°C | | -0.04 | | +0.04 | % |
| | | MAX6070B/MAX6071B, T _A = +25°C | | -0.08 | | +0.08 | |
| Output Voltage Temperature Drift (Note 3) | TCV _{OUT} | MAX6070A/MAX6071A | | | 1.5 | 6 | ppm/°C |
| | | MAX6070B/MAX6071B | | | 2.0 | 8 | |
| Line Regulation | | Over specified V _{IN} range | T _A = +25°C | | 200 | 400 | μV/V |
| | | | T _A = T _{MIN} to T _{MAX} | | | 500 | |
| Load Regulation | | 0mA < I _{OUT} < 10mA, sink | | | 160 | 275 | μV/mA |
| | | 0mA < I _{OUT} < 10mA, source | | | 160 | 275 | |
| Dropout Voltage | | I _{OUT} = 10mA, T _A = T _{MIN} to T _{MAX} (Note 6) | | | 60 | 150 | mV |
| Output Current | I _{OUT} | | | -10 | | +10 | mA |
| Short-Circuit Current | I _{SC} | Sourcing to ground | | | 25 | | mA |
| | | Sinking from V _{IN} | | | 25 | | |
| Long-Term Stability | | 1000 hours at T _A = +25°C | | | 35 | | ppm |
| Thermal Hysteresis | | (Note 5) | | | 85 | | ppm |
| DYNAMIC CHARACTERISTICS | | | | | | | |
| Noise Voltage | e _{OUT} | 1/f noise, 0.1Hz to 10Hz, C _{OUT} = 0.1μF | | | 9 | | μV _{P-P} |
| | | MAX6071 thermal noise, 10Hz to 10kHz, C _{OUT} = 0.1μF | | | 15 | | μV _{RMS} |
| | | MAX6070 thermal noise, 10Hz to 10kHz, C _{OUT} = 0.1μF, C _{FILTER} = 0.1μF | | | 12 | | |
| Ripple Rejection | | Frequency = 60Hz | | | 74 | | dB |
| Turn-On Settling Time | t _R | Settling to 0.01%, C _{OUT} = 0.1μF | MAX6070, C _{FILTER} = 0.1μF | | 10 | | ms |
| | | | MAX6071 | | 50 | | μs |
| Enable Settling Time | t _{EN} | Settling to 0.01%, C _{OUT} = 0.1μF | MAX6070, C _{FILTER} = 0.1μF | | 10 | | ms |
| | | | MAX6071 | | 100 | | μs |
| Capacitive-Load Stability Range | | I _{OUT} ≤ 10mA | | 0.1 | | 10 | μF |

Electrical Characteristics—MAX607__AUT50 ($V_{OUT} = 5.000V$) (continued)

($V_{IN} = +5.5V$, $I_{OUT} = 0mA$, $C_{OUT} = 0.1\mu F$, $T_A = -40^{\circ}C$ to $+125^{\circ}C$, unless otherwise noted. Typical values are at $T_A = +25^{\circ}C$.) (Note 2)

| PARAMETER | SYMBOL | CONDITIONS | MIN | TYP | MAX | UNITS |
|--------------------------|----------|-------------------------------|---------------------|-----|---------------------|---------|
| INPUT | | | | | | |
| Supply Voltage | V_{IN} | Guaranteed by line regulation | 5.2 | | 5.5 | V |
| Quiescent Supply Current | I_{IN} | $T_A = +25^{\circ}C$ | | 160 | 250 | μA |
| | | $T_A = T_{MIN}$ to T_{MAX} | | | 330 | |
| Shutdown Supply Current | I_{SD} | | | | 6 | μA |
| ENABLE | | | | | | |
| Enable Input Current | I_{EN} | | -1 | | +1 | μA |
| Enable Logic-High | V_{IH} | | $0.7 \times V_{IN}$ | | | V |
| Enable Logic-Low | V_{IL} | | | | $0.3 \times V_{IN}$ | |

Note 2: Limits are 100% production tested at $T_A = +25^{\circ}C$. Specifications where $T_A < +25^{\circ}C$ or $T_A > +25^{\circ}C$ are guaranteed by design and characterization.

Note 3: Temperature coefficient is calculated using the "box method" which measures temperature drift as the maximum voltage variation over a specified temperature range. The unit of measurement is ppm/ $^{\circ}C$.

Note 4: Dropout voltage is defined as the minimum differential voltage ($V_{IN} - V_{OUT}$) at which V_{OUT} decreases by 0.2% from its original value at $V_{IN} = 5.0V$.

Note 5: Thermal hysteresis is defined as the change in $+25^{\circ}C$ output voltage before and after cycling the device from T_{MAX} to T_{MIN} .

Note 6: Dropout voltage is defined as the minimum differential voltage ($V_{IN} - V_{OUT}$) at which V_{OUT} decreases by 0.2% from its original value at $V_{IN} = 5.5V$.

Typical Operating Characteristics

($T_A = +25^\circ\text{C}$, unless otherwise noted.)

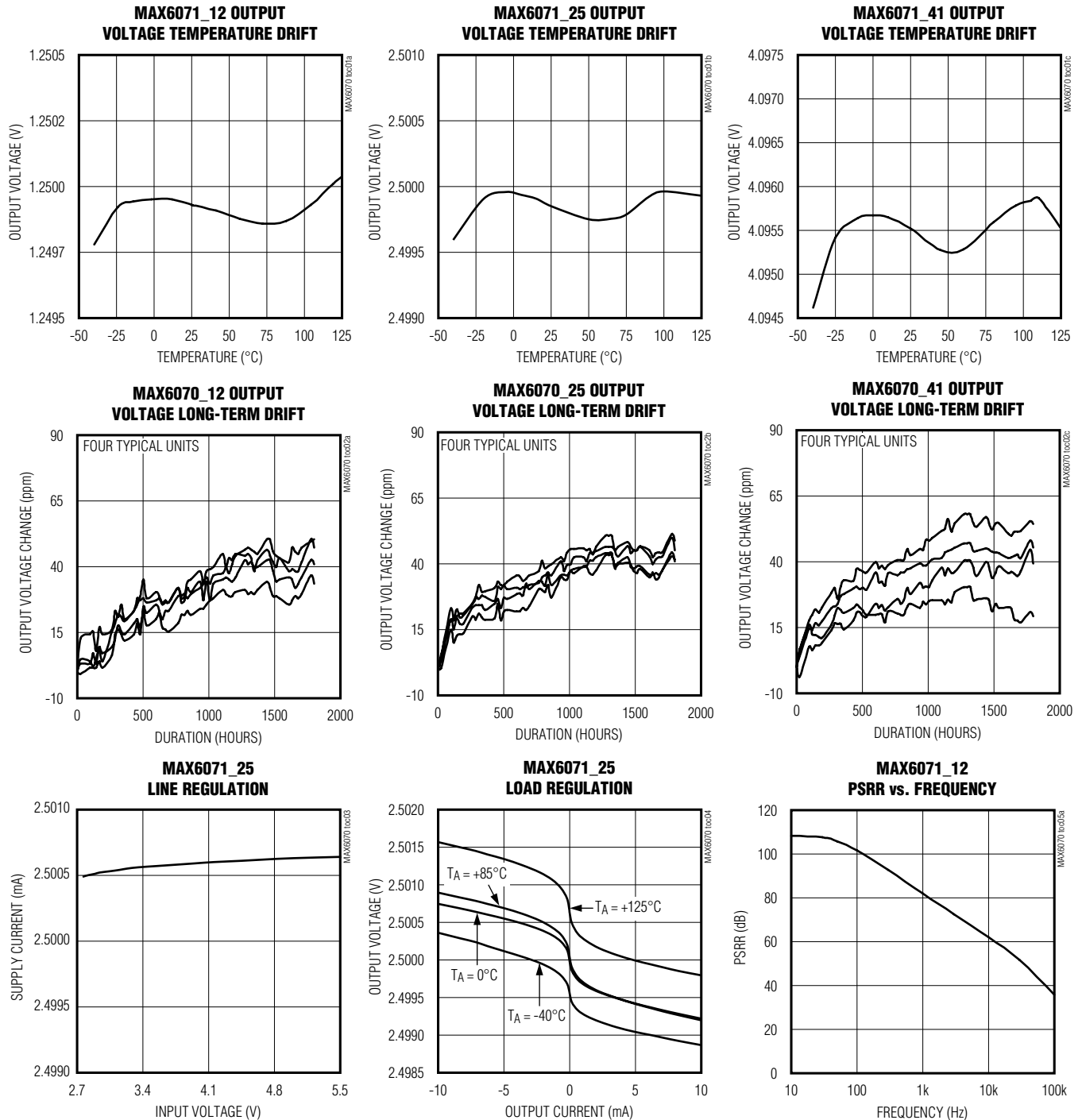

Typical Operating Characteristics (continued)

(T_A = +25°C, unless otherwise noted.)

MAX6071_25
PSRR vs. FREQUENCY

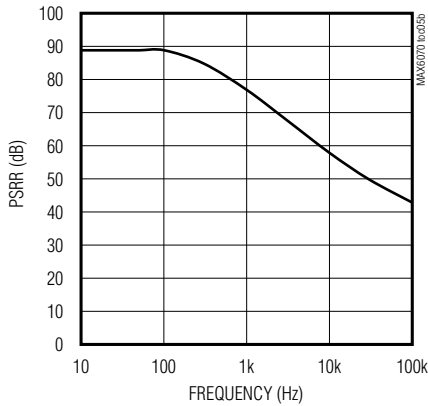

MAX6071_41
PSRR vs. FREQUENCY

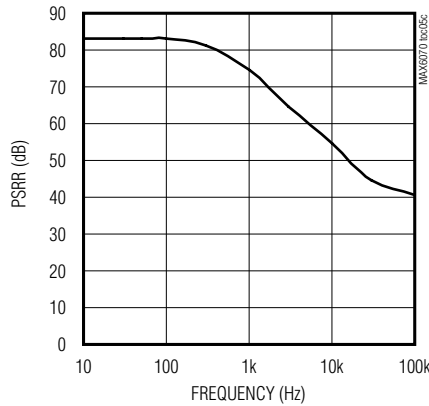

MAX6071_12
SUPPLY CURRENT vs. INPUT VOLTAGE

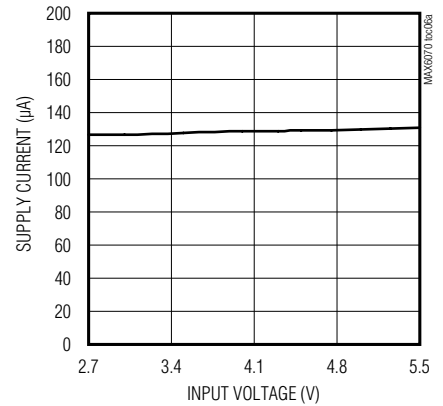

MAX6071_25
SUPPLY CURRENT vs. INPUT VOLTAGE

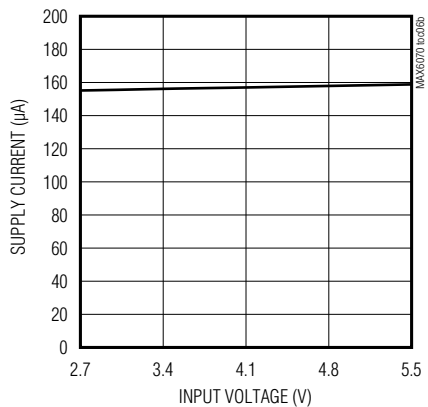

MAX6071_41
SUPPLY CURRENT vs. INPUT VOLTAGE

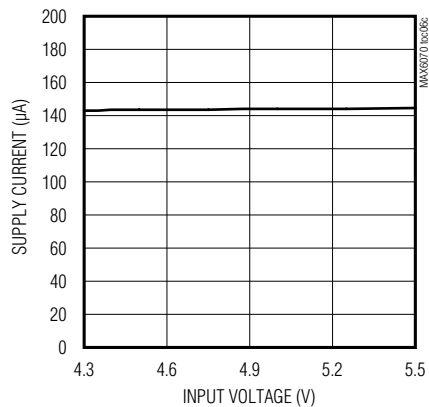

MAX6071_12
R_{OUT} vs. FREQUENCY

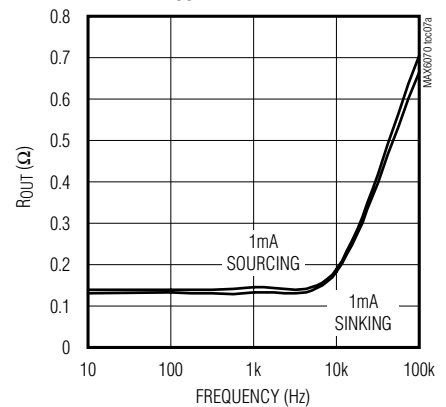

MAX6071_25
R_{OUT} vs. FREQUENCY

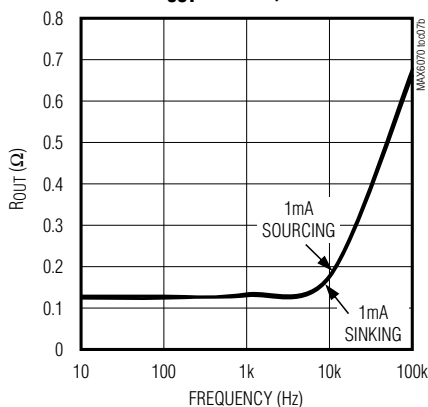

MAX6071_41
R_{OUT} vs. FREQUENCY

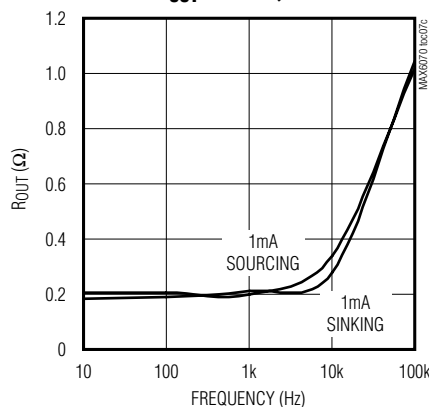

MAX6071_12
SUPPLY CURRENT vs. TEMPERATURE

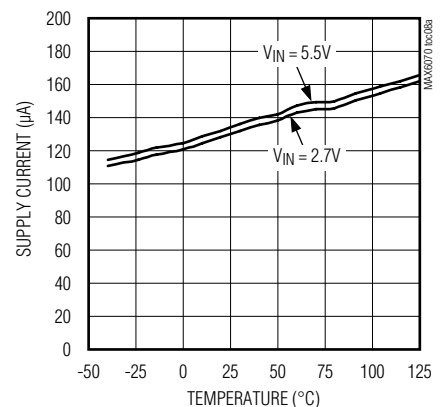

Typical Operating Characteristics (continued)

($T_A = +25^\circ\text{C}$, unless otherwise noted.)

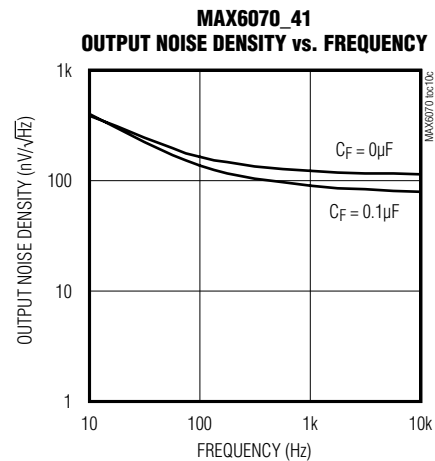
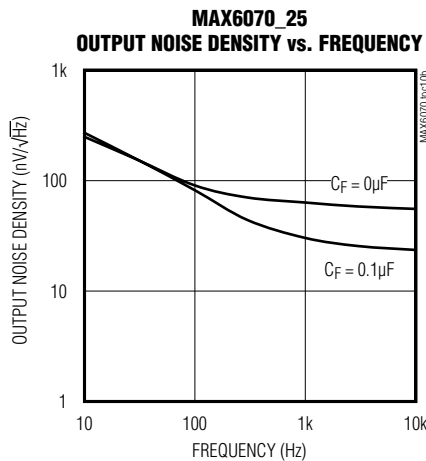
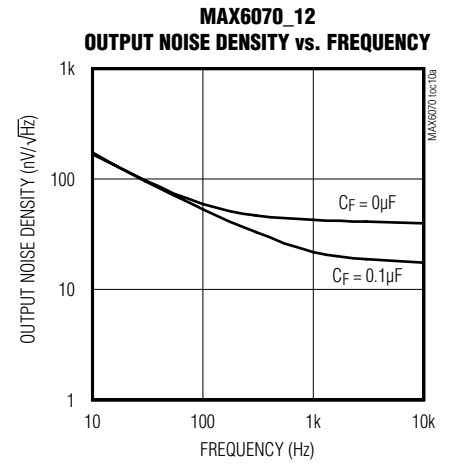
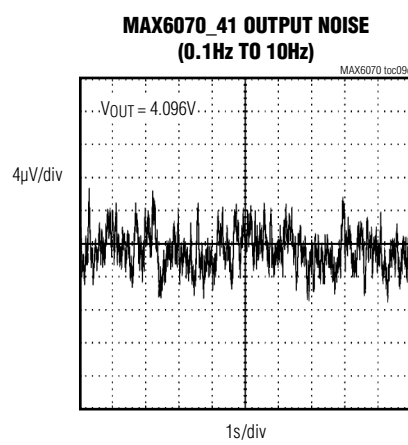
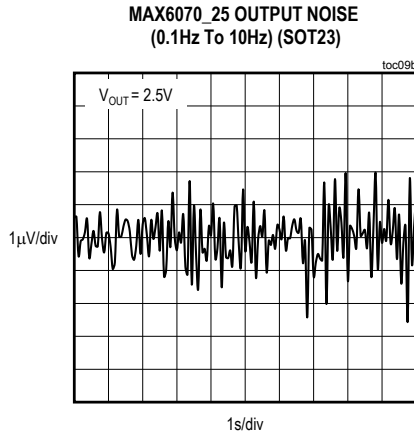
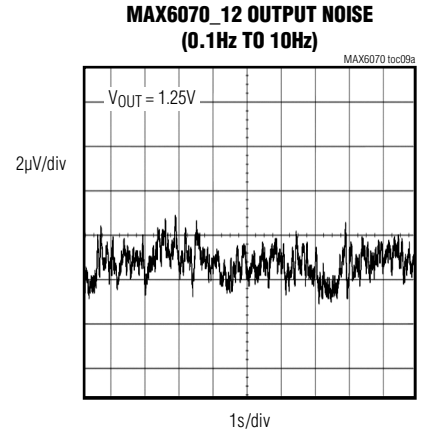
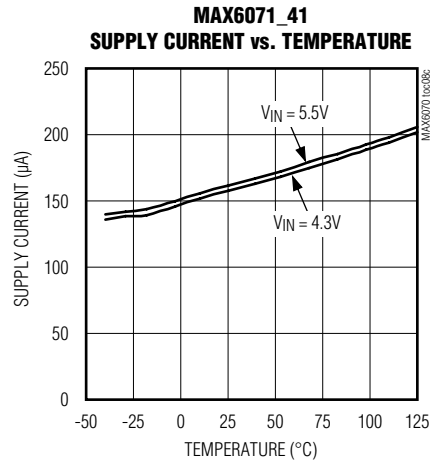
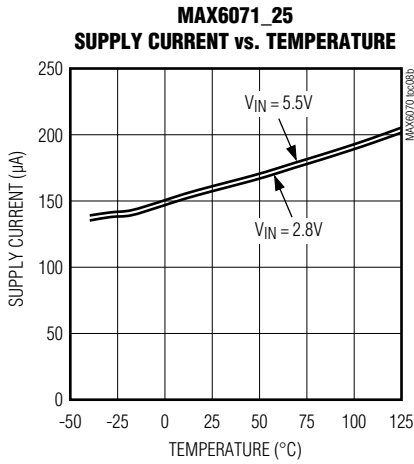

Typical Operating Characteristics (continued)

($T_A = +25^\circ\text{C}$, unless otherwise noted.)

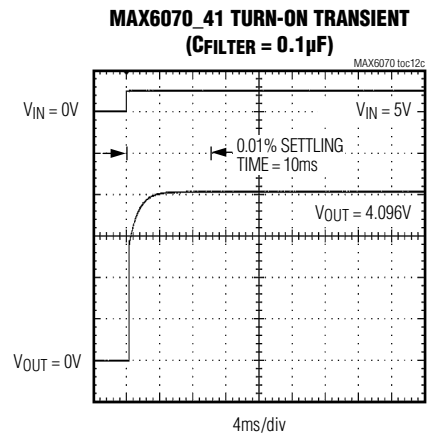
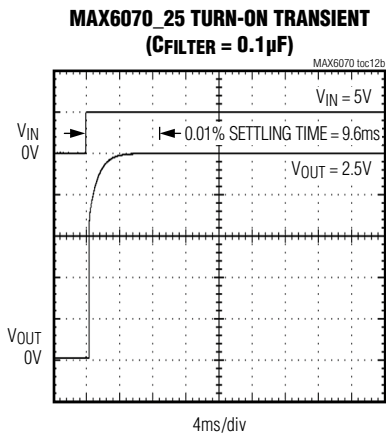
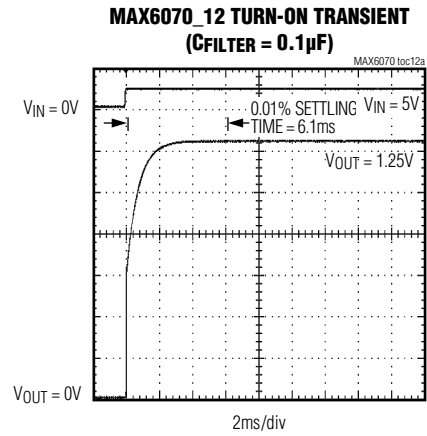
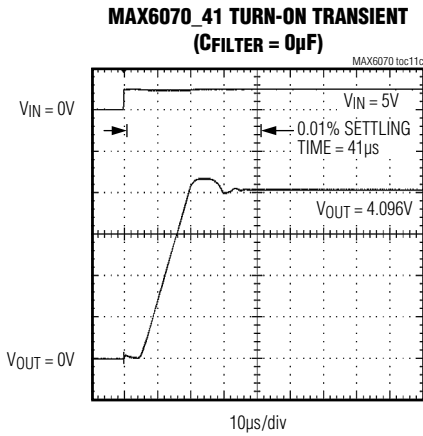
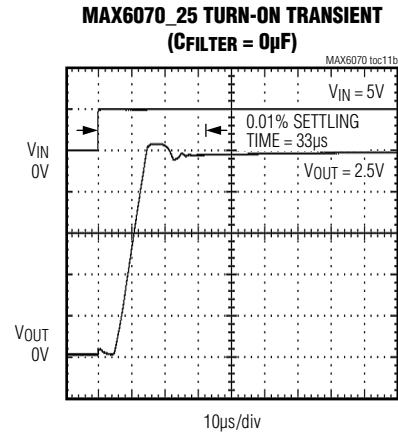
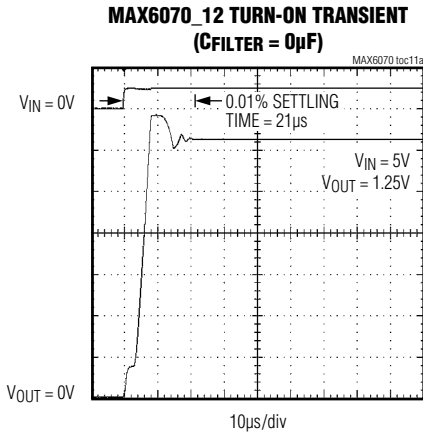

Typical Operating Characteristics (continued)

($T_A = +25^\circ\text{C}$, unless otherwise noted.)

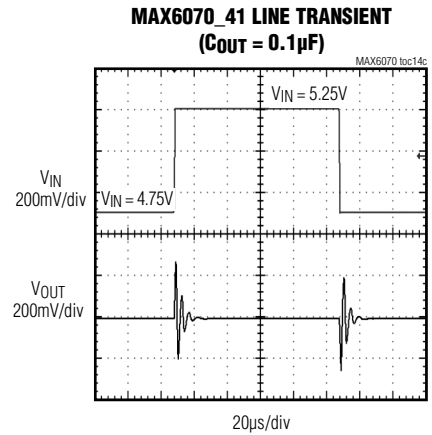
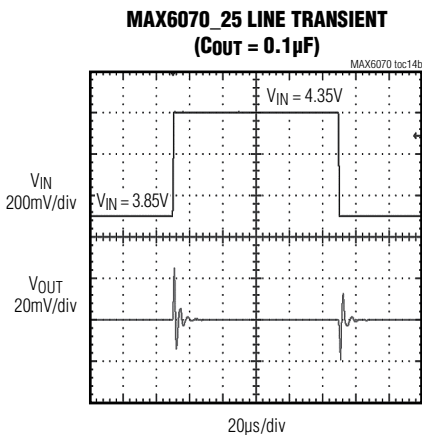
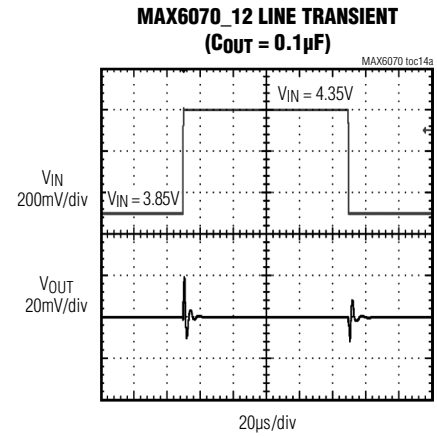
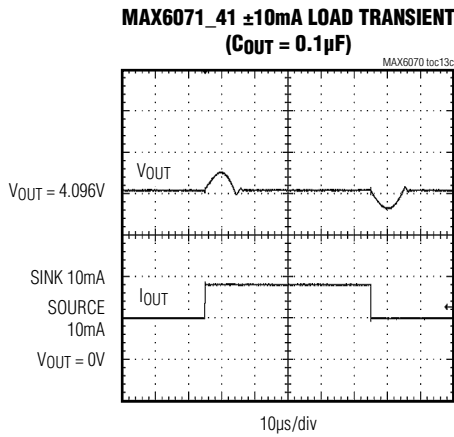
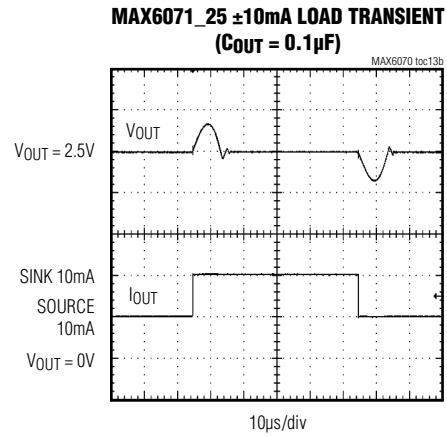
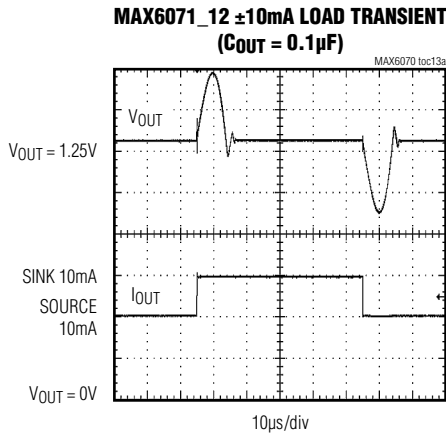

Typical Operating Characteristics (continued)

($T_A = +25^\circ\text{C}$, unless otherwise noted.)

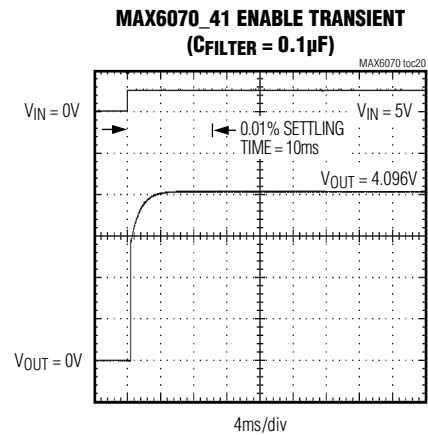
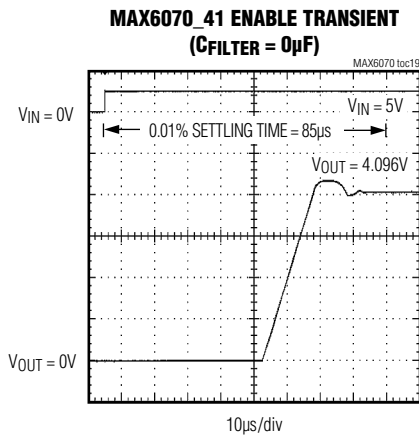
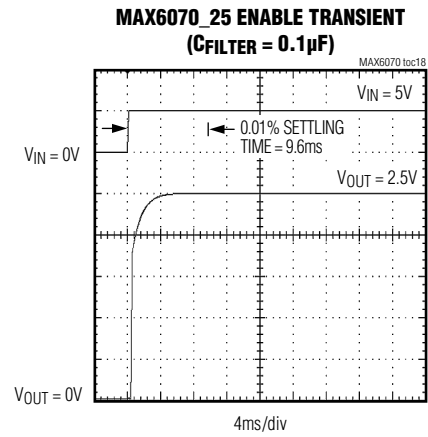
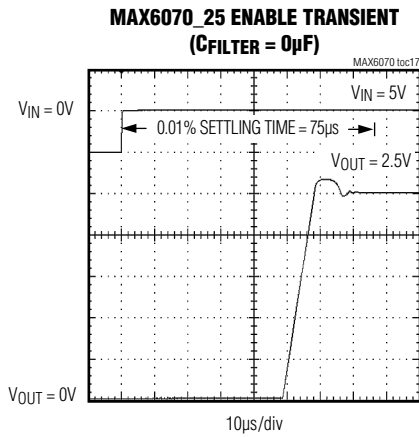
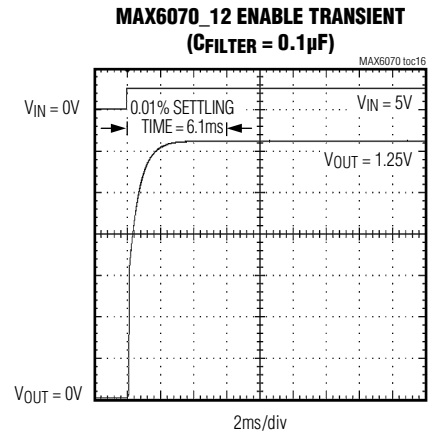
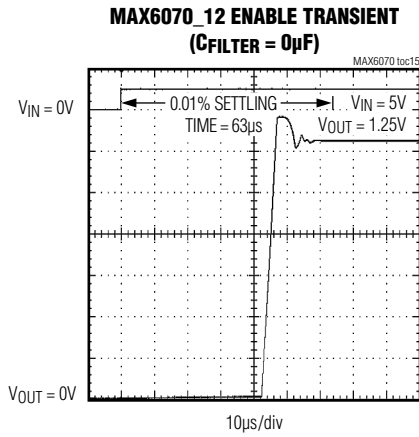

Pin Configurations

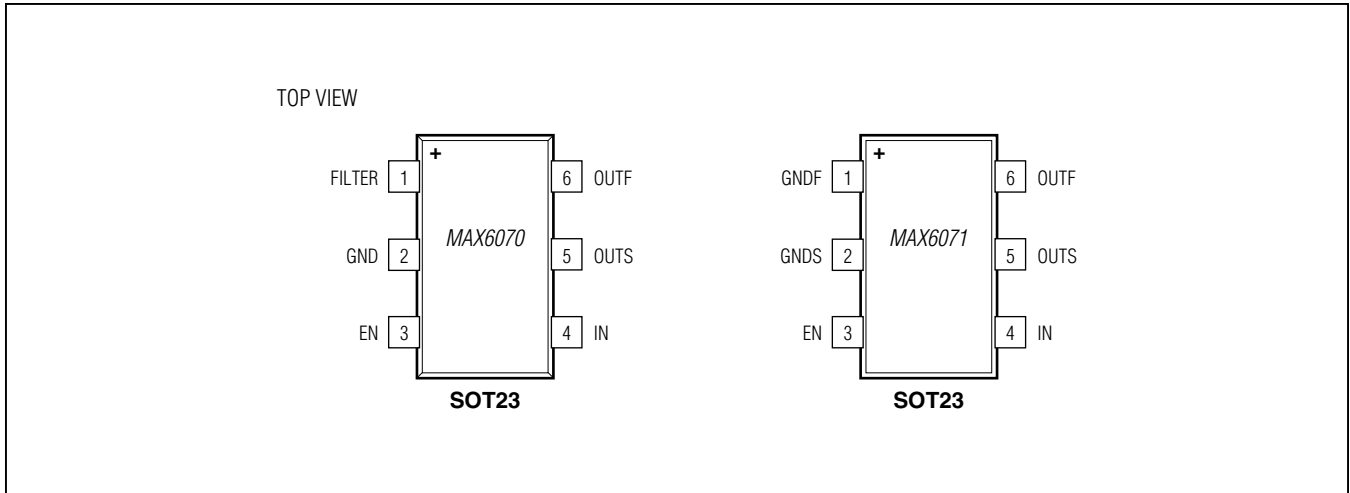

Pin Description

| PIN | | NAME | FUNCTION |
|---------|---------|--------|---|
| MAX6070 | MAX6071 | | |
| 1 | — | FILTER | Filter Input. Connect a 0.1µF capacitor from FILTER to ground to provide high-frequency bypass. Leave unconnected, if not used. |
| — | 1 | GNDF | Ground Force |
| 2 | — | GND | Ground |
| - | 2 | GNDS | Ground Sense. Connect to ground connection at the load. |
| 3 | 3 | EN | Enable. Drive high to enable the device. Drive low to disable the device. |
| 4 | 4 | IN | Supply Input |
| 5 | 5 | OUTS | Voltage Reference Sense Output |
| 6 | 6 | OUTF | Voltage Reference Force Output. Short OUTF to OUTS as close as possible to the load. Bypass OUTF with a capacitor (0.1µF to 10µF) to GND. |

Detailed Description

Wideband Noise Reduction (FILTER)

To improve wideband noise and transient power-supply noise with the MAX6070, connect a 0.1 μ F capacitor from FILTER to GND (see the [Typical Operating Characteristics](#)). Larger values do not appreciably improve noise reduction. A 0.1 μ F capacitor reduces the spectral noise density at 1kHz from 60nV/ $\sqrt{\text{Hz}}$ to 30nV/ $\sqrt{\text{Hz}}$ for the 2.5V output. Noise at the input pin can affect output noise, but can be reduced by connecting an optional bypass capacitor between IN and GND as shown in [Figure 1](#).

Output Bypassing

The MAX6070/MAX6071 require an output capacitor between 0.1 μ F and 10 μ F. Place the output capacitor as close to OUTF as possible. For applications driving switching capacitive loads or rapidly changing load currents, use a 0.1 μ F capacitor in parallel with a larger load capacitor to reduce equivalent series resistance (ESR). Larger capacitor values and lower ESR reduce transients on the reference output.

Supply Current

The MAX6070/MAX6071 draw 150 μ A of current and are virtually independent of the supply voltage, with only a 1.6 μ A/V variation with supply voltage.

Thermal Hysteresis

Thermal hysteresis is the change of output voltage at $T_A = +25^\circ\text{C}$ before and after the device is cycled over its entire operating temperature range. The typical thermal hysteresis value is 85ppm.

Turn-On Time

These devices typically turn on and settle to within 0.01% of their final value in 30 μ s. A noise reduction capacitor of 0.1 μ F increases the turn-on time of the MAX6070 to 10ms.

Output Force and Sense

The MAX6070/MAX6071 provide independent connections for the force output (OUTF) supplying current to the load and the circuit input regulating the load voltage via the output sense pin (OUTS). This configuration allows for the cancellation of the voltage drop on the lines connecting the MAX6070/MAX6071 and the load. When using the Kelvin connection made possible by the independent force and sense outputs, connect OUTF to the load and

connect OUTS to OUTF at the point where the voltage accuracy is needed (see [Figure 1](#)). The MAX6071 features the same type of Kelvin connection to cancel drops in the ground return line. Connect the load to ground and connect GNDS to ground as close as possible to the load ground connection (see [Figure 2](#)).

Shutdown

The MAX6070/MAX6071 feature an active-high enable pin (EN). Pulling EN low disables the output with a resistive load to ground and forces the quiescent current to less than 1 μ A. The value of the load is typically 200k Ω . Pulling EN high enables normal operation.

Applications Information

Wideband Noise Reduction

[Figure 1](#) shows a typical noise reduction filter application circuit. Note that the use of the wideband noise filter will increase turn-on time.

High-Resolution DAC and Reference from a Single Supply

[Figure 2](#) shows a typical circuit providing the reference for a high-resolution, 16-bit MAX541 DAC.

Precision Current Source

[Figure 3](#) shows a typical circuit providing a precision current source. The OUTF output provides the bias current for the bipolar transistor. OUTS and GNDS sense the voltage across the resistor and adjust the current sourced by OUTF accordingly.

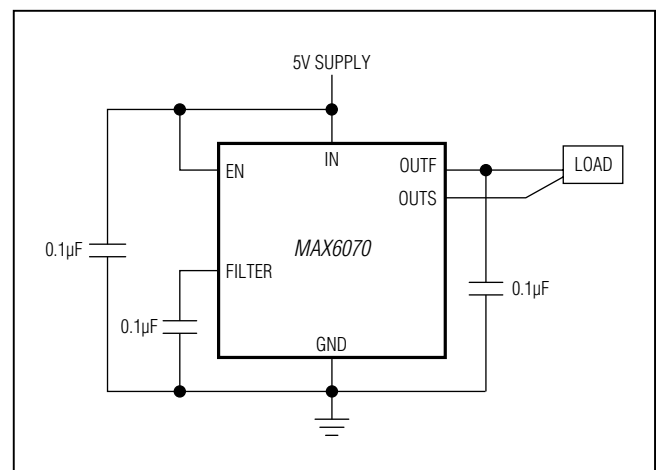

Figure 1. Reference Output Kelvin Connection

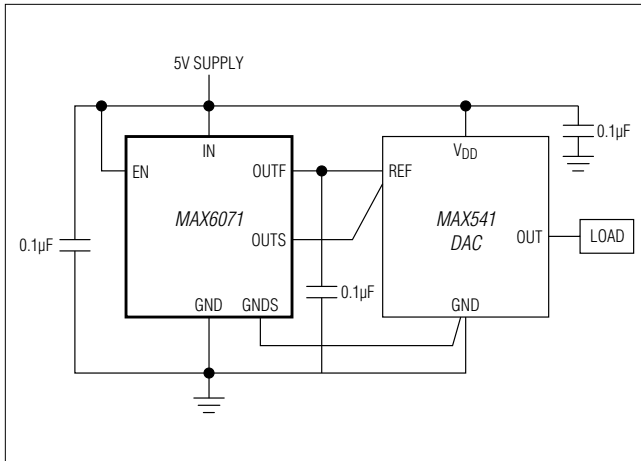

Figure 2. Reference Ground Kelvin Connection

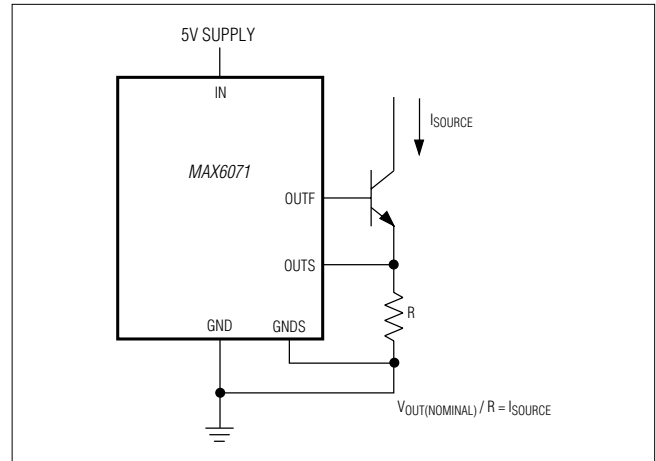

Figure 3. Precision Current Source

Selector Guide

| PART | FILTER | V _{OUT} (V) | ACCURACY (%) | TOP MARK |
|-------------------|--------|----------------------|--------------|----------|
| MAX6070AAUT12+T | Yes | 1.25 | 0.04 | +ACPF |
| MAX6070AAUT18+T | Yes | 1.8 | 0.04 | +ACPH |
| MAX6070AAUT21+T | Yes | 2.048 | 0.04 | +ACPJ |
| MAX6070AAUT25+T | Yes | 2.5 | 0.04 | +ACPL |
| MAX6070AAUT30+T | Yes | 3.0 | 0.04 | +ACPN |
| MAX6070AAUT33+T | Yes | 3.3 | 0.04 | +ACPP |
| MAX6070AAUT41+T | Yes | 4.096 | 0.04 | +ACPR |
| MAX6070AAUT50+T | Yes | 5.0 | 0.04 | +ACPV |
| MAX6070AAUT50/V+T | Yes | 5.0 | 0.04 | +ACTR |
| MAX6070BAUT12+T | Yes | 1.25 | 0.08 | +ACPG |
| MAX6070BAUT12/V+T | Yes | 1.25 | 0.08 | +ACSP |
| MAX6070BAUT18+T | Yes | 1.8 | 0.08 | +ACPI |
| MAX6070BAUT21+T | Yes | 2.048 | 0.08 | +ACPK |
| MAX6070BAUT25+T | Yes | 2.5 | 0.08 | +ACPM |
| MAX6070BAUT25/V+T | Yes | 2.5 | 0.08 | +ACTS |
| MAX6070BAUT30+T | Yes | 3.0 | 0.08 | +ACPO |
| MAX6070BAUT33+T | Yes | 3.3 | 0.08 | +ACPQ |
| MAX6070BAUT41+T | Yes | 4.096 | 0.08 | +ACPS |
| MAX6070BAUT41/V+T | Yes | 4.1 | 0.08 | +ACTT |
| MAX6070BAUT50+T | Yes | 5.0 | 0.08 | +ACPW |
| MAX6071AAUT12+T | No | 1.25 | 0.04 | +ACPX |

V denotes an automotive qualified part.
*+*Denotes a lead(Pb)-free/RoHS-compliant package.
T = Tape and reel.

Selector Guide (continued)

| PART | FILTER | V _{OUT} (V) | ACCURACY (%) | TOP MARK |
|------------------|--------|----------------------|--------------|----------|
| MAX6071AAUT18+T | No | 1.8 | 0.04 | +ACPZ |
| MAX6071AAUT21+T | No | 2.048 | 0.04 | +ACQB |
| MAX6071AAUT25+T | No | 2.5 | 0.04 | +ACQD |
| MAX6071AAUT30+T | No | 3.0 | 0.04 | +ACQF |
| MAX6071AAUT33+T | No | 3.3 | 0.04 | +ACQH |
| MAX6071AAUT41+T | No | 4.096 | 0.04 | +ACQJ |
| MAX6071AAUT50+T | No | 5.0 | 0.04 | +ACQN |
| MAX6071BAUT12+T | No | 1.25 | 0.08 | +ACPY |
| MAX6071BAUT18+T | No | 1.8 | 0.08 | +ACQA |
| MAX6071BAUT21+T | No | 2.048 | 0.08 | +ACQC |
| MAX6071BAUT25+T | No | 2.5 | 0.08 | +ACQE |
| MAX6071BAUT25V+T | No | 2.5 | 0.08 | +ACTU |
| MAX6071BAUT30+T | No | 3.0 | 0.08 | +ACQG |
| MAX6071BAUT33+T | No | 3.3 | 0.08 | +ACQI |
| MAX6071BAUT41+T | No | 4.096 | 0.08 | +ACQK |
| MAX6071BAUT41V+T | No | 4.1 | 0.08 | +ACTV |
| MAX6071BAUT50+T | No | 5.0 | 0.08 | +ACQO |
| MAX6071BAUT50V+T | No | 5.0 | 0.08 | +ACTW |

Ordering Information

| PART | TEMP RANGE | PIN-PACKAGE |
|-----------------|-----------------|-------------|
| MAX6070_AUT_+_T | -40°C to +125°C | 6 SOT23 |
| MAX6071_AUT_+_T | -40°C to +125°C | 6 SOT23 |

+Denotes a lead(Pb)-free/RoHS-compliant package.

T = Tape and reel.

Note: The MAX6070/MAX6071 are available in A or B grade with various output voltages. Choose the desired grade and output voltage from the Selector Guide and insert the suffix in the blank above to complete the part number.

Chip Information

PROCESS: BIPOLAR

Package Information

For the latest package outline information and land patterns (footprints), go to www.maximintegrated.com/packages. Note that a "+", "#", or "-" in the package code indicates RoHS status only. Package drawings may show a different suffix character, but the drawing pertains to the package regardless of RoHS status.

| PACKAGE TYPE | PACKAGE CODE | DOCUMENT NO. | LAND PATTERN NO. |
|--------------|--------------|--------------|------------------|
| SOT23-6 | U6+5 | 21-0058 | 90-0175 |

Revision History

| REVISION NUMBER | REVISION DATE | DESCRIPTION | PAGES CHANGED |
|-----------------|---------------|---|-----------------|
| 0 | 10/12 | Initial release | — |
| 1 | 1/13 | Added 2.048V, 3.0V, and 5.0V options to data sheet. Revised <i>General Description, Benefits and Features, Absolute Maximum Ratings, Electrical Characteristics, and Selector Guide</i> . | 1–9, 17, 18 |
| 2 | 3/13 | Added 1.8V and 3.3V options to data sheet. Revised <i>General Description, Benefits and Features, Electrical Characteristics, and Selector Guide</i> . | 1, 2–12, 21, 22 |
| 3 | 2/14 | Added automotive package for the MAX6070B. | 21 |
| 4 | 7/15 | Added automotive packages to data sheet and revised TOC9b. Revised <i>Benefits and Features</i> section. | 1, 16, 22, 23 |

For pricing, delivery, and ordering information, please contact Maxim Direct at 1-888-629-4642, or visit Maxim Integrated's website at www.maximintegrated.com.

Maxim Integrated cannot assume responsibility for use of any circuitry other than circuitry entirely embodied in a Maxim Integrated product. No circuit patent licenses are implied. Maxim Integrated reserves the right to change the circuitry and specifications without notice at any time. The parametric values (min and max limits) shown in the Electrical Characteristics table are guaranteed. Other parametric values quoted in this data sheet are provided for guidance.



Компания «ЭлектроПласт» предлагает заключение долгосрочных отношений при поставках импортных электронных компонентов на взаимовыгодных условиях!

Наши преимущества:

- Оперативные поставки широкого спектра электронных компонентов отечественного и импортного производства напрямую от производителей и с крупнейших мировых складов;
- Поставка более 17-ти миллионов наименований электронных компонентов;
- Поставка сложных, дефицитных, либо снятых с производства позиций;
- Оперативные сроки поставки под заказ (от 5 рабочих дней);
- Экспресс доставка в любую точку России;
- Техническая поддержка проекта, помощь в подборе аналогов, поставка прототипов;
- Система менеджмента качества сертифицирована по Международному стандарту ISO 9001;
- Лицензия ФСБ на осуществление работ с использованием сведений, составляющих государственную тайну;
- Поставка специализированных компонентов (Xilinx, Altera, Analog Devices, Intersil, Interpoint, Microsemi, Aeroflex, Peregrine, Syfer, Eurofarad, Texas Instrument, Miteq, Cobham, E2V, MA-COM, Hittite, Mini-Circuits, General Dynamics и др.);

Помимо этого, одним из направлений компании «ЭлектроПласт» является направление «Источники питания». Мы предлагаем Вам помощь Конструкторского отдела:

- Подбор оптимального решения, техническое обоснование при выборе компонента;
- Подбор аналогов;
- Консультации по применению компонента;
- Поставка образцов и прототипов;
- Техническая поддержка проекта;
- Защита от снятия компонента с производства.



Как с нами связаться

Телефон: 8 (812) 309 58 32 (многоканальный)

Факс: 8 (812) 320-02-42

Электронная почта: org@eplast1.ru

Адрес: 198099, г. Санкт-Петербург, ул. Калинина, дом 2, корпус 4, литера А.