

Low clamping, single-line unidirectional ESD protection for high speed interface

Datasheet – production data

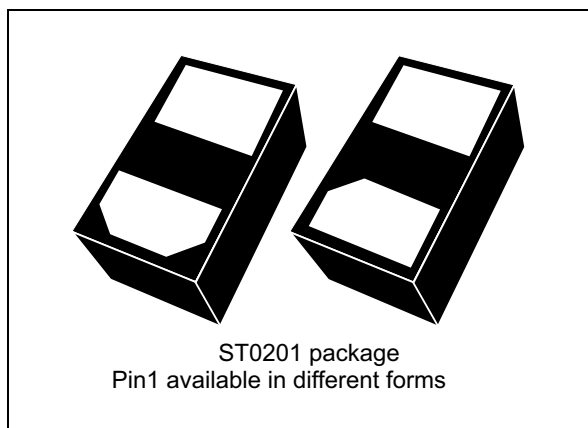
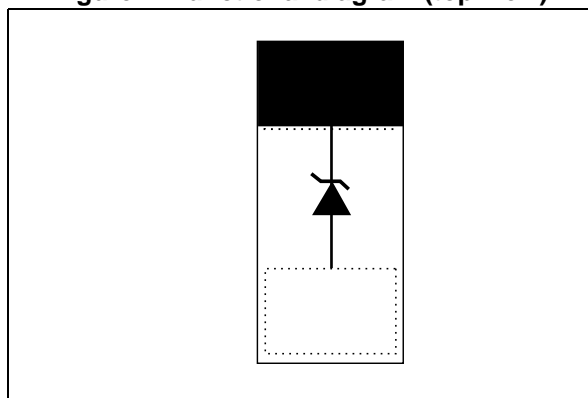

Figure 1. Functional diagram (top view)



Features

- Unidirectional device
- Low clamping voltage:
 - 10.4 V IEC 61000-4-2, 8 kV contact measured at 30 ns
 - 13.7 V TLP 16 A I_{pp}
- Very high bandwidth: 11.4 GHz
- 0201 package
- Ultra low PCB area: 0.18 mm²
- ECOPACK[®]2 and RoHS compliant component

Complies with the following standards:

- IEC 61000-4-2 level 4 (exceed level4)
 - ±30 kV (air discharge)
 - ±16 kV (contact discharge)

Applications

Where transient overvoltage protection in ESD sensitive equipment is required, such as:

- Smartphones, mobile phone and accessories
- Tablet PCs, netbooks and notebooks
- Portable multimedia devices and accessories
- Digital cameras and camcorders
- Communication and highly integrated systems

Description

The ESDAXLC5-1U2 is a unidirectional single line TVS diode designed to protect data lines or other I/O ports against ESD transients.

The device is ideal for applications where both reduced line capacitance and board space saving are required.

1 Characteristics

Table 1. Absolute maximum ratings ($T_{amb} = 25\text{ }^{\circ}\text{C}$)

Symbol	Parameter	Value	Unit
V_{PP}	Peak pulse voltage: IEC 61000-4-2 contact discharge IEC 61000-4-2 air discharge	± 16 ± 30	kV
P_{PP}	Peak pulse power (8/20 μs) ⁽¹⁾	20	W
I_{PP}	Peak pulse current (8/20 μs) ⁽¹⁾	2.2	A
T_j	Operating junction temperature range	- 55 to +150	$^{\circ}\text{C}$
T_{stg}	Storage temperature range	- 65 to +150	$^{\circ}\text{C}$
T_L	Maximum lead temperature for soldering during 10 s	260	$^{\circ}\text{C}$

1. According to IEC61000-4-5, for a surge greater than the maximum values, the diode will fail in short-circuit.

Figure 2. Electrical characteristics (definitions)

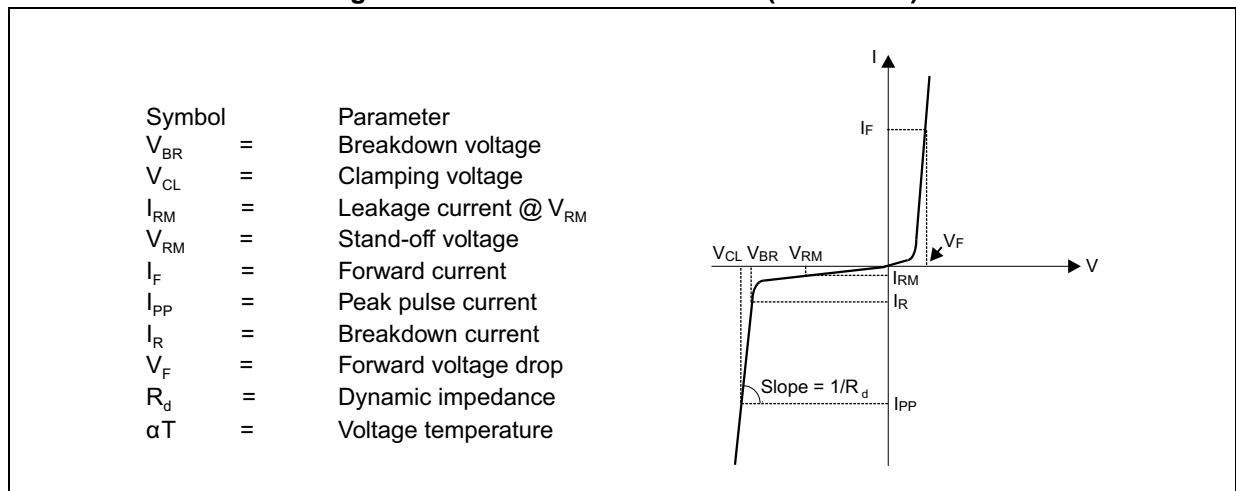

Table 2. Electrical characteristics (values, $T_{amb} = 25\text{ }^{\circ}\text{C}$)

Symbol	Parameter	Test Condition	Min.	Typ.	Max.	Unit
V_{BR}	Breakdown voltage	$I_R = 1\text{ mA}$	5	6.6		V
V_{RM}	Reverse working voltage				3.6	V
I_{RM}	Leakage current	$V_{RM} = 3.6\text{ V}$		4	100	nA
C_{line}	Line capacitance	$F = (200\text{ MHz} - 3000\text{ MHz}), V_{LINE} = 0\text{ V}$		0.55	0.7	pF
V_{CL}	Reverse clamping voltage	$I_{PP} = 1\text{ A}, 8/20\text{ }\mu\text{s}$		7		V
		$I_{PP} = 2.2\text{ A}, 8/20\text{ }\mu\text{s}$		8		
		IEC 61000-4-2, 8 kV contact measured at 30 ns		10.4		
		TLP measurement (pulse duration 100 ns), $I_{PP} = 16\text{ A}^{(1)}$		13.7		
R_d	Dynamic resistance ⁽¹⁾	Pulse duration 100 ns ⁽¹⁾	Direct		0.39	Ω
			Forward		0.52	
V_{FCL}	Forward clamping voltage	$I_{PP} = 1\text{ A}, 8/20\text{ }\mu\text{s}$		2.5		V
		$I_{PP} = 2.2\text{ A}, 8/20\text{ }\mu\text{s}$		4.0		
		TLP measurement (pulse duration 100 ns), $I_{PP} = 16\text{ A}^{(1)}$		10.4		
F_C	Cut-off frequency	-3 dB		11.4		GHz

1. More information is available in ST application note: AN4022

Figure 3. Leakage current versus junction temperature (typical values)

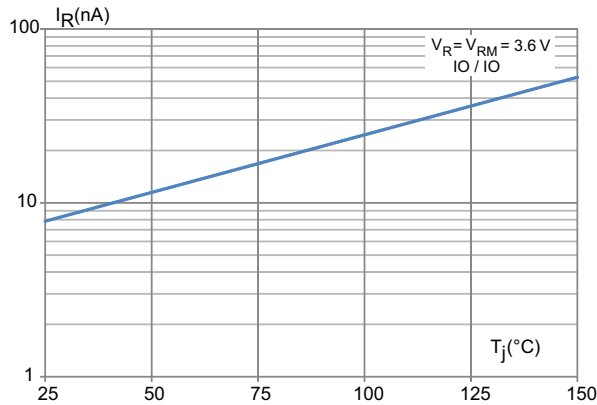

Figure 4. Junction capacitance versus frequency (typical values)

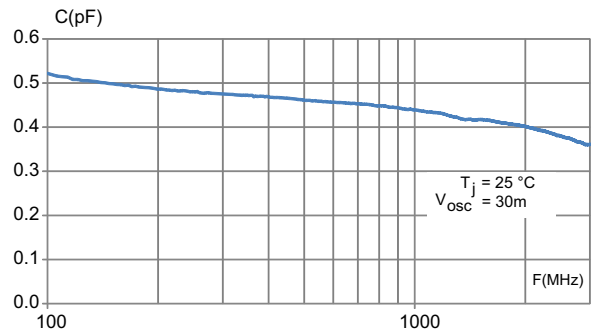

Figure 5. ESD response to IEC 61000-4-2 (+8 kV contact discharge)

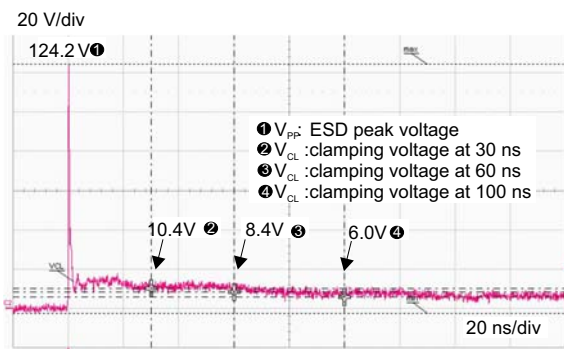

Figure 6. ESD response to IEC 61000-4-2 (-8 kV contact discharge)

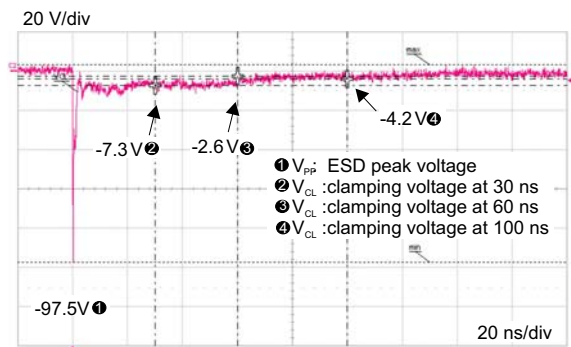

Figure 7. S21 attenuation measurement results

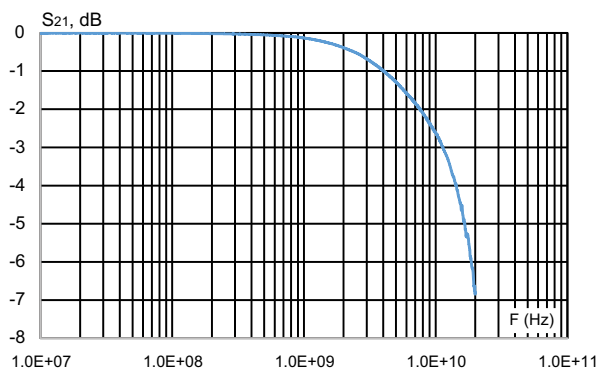
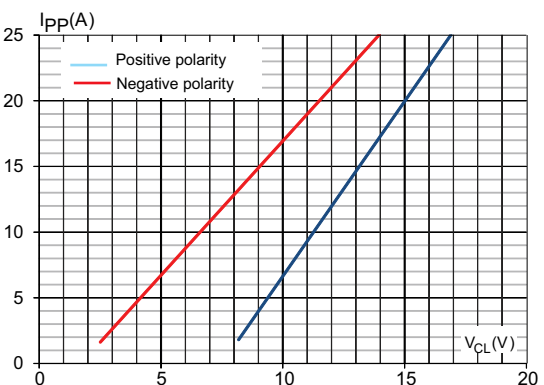

Figure 8. TLP measurements



2 Package information

- Epoxy meets UL94, V0
- Bar indicates pin 1

In order to meet environmental requirements, ST offers these devices in different grades of ECOPACK® packages, depending on their level of environmental compliance. ECOPACK® specifications, grade definitions and product status are available at: www.st.com. ECOPACK® is an ST trademark.

2.1 ST0201 package information

Figure 9. ST0201 package outline

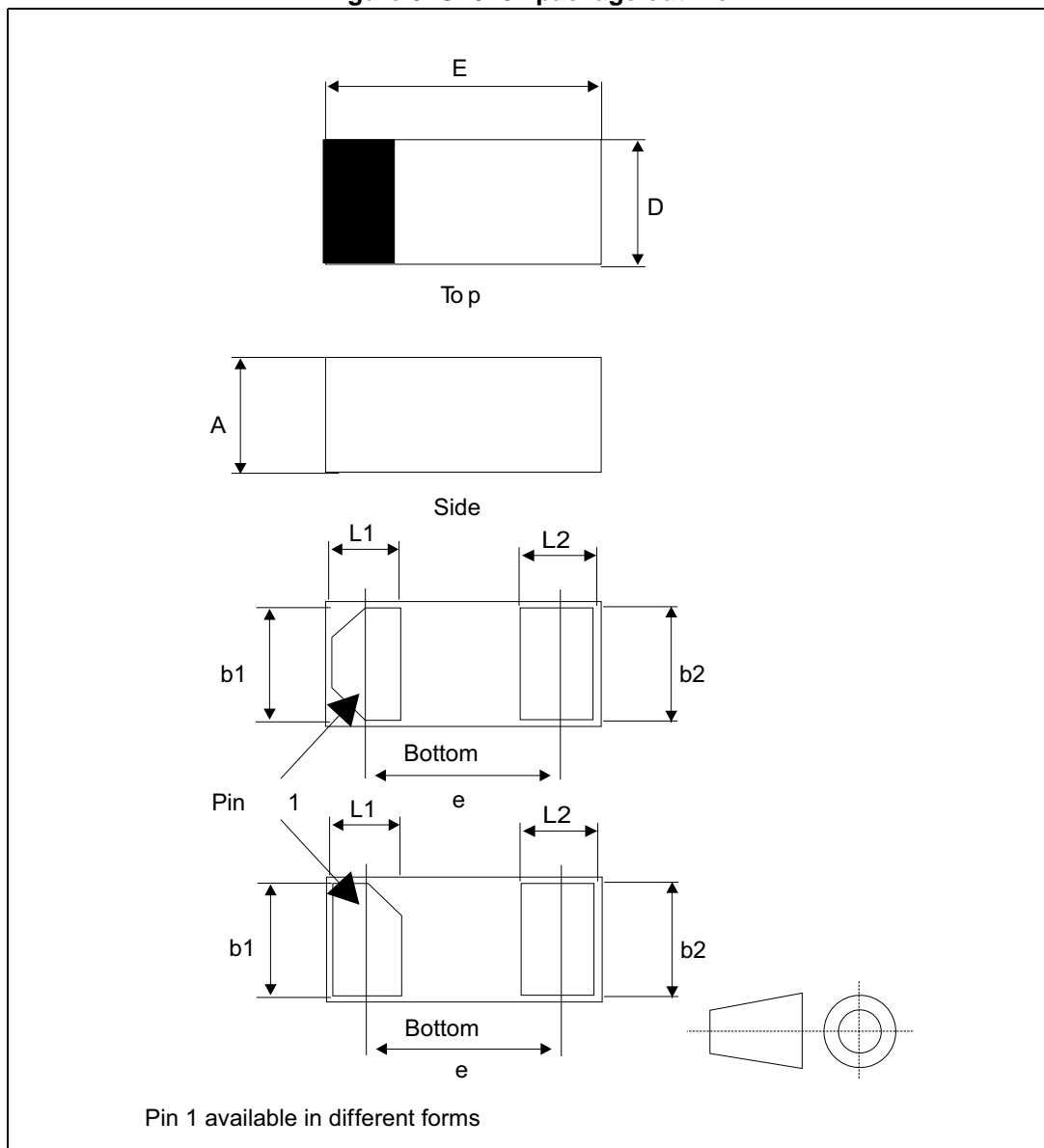
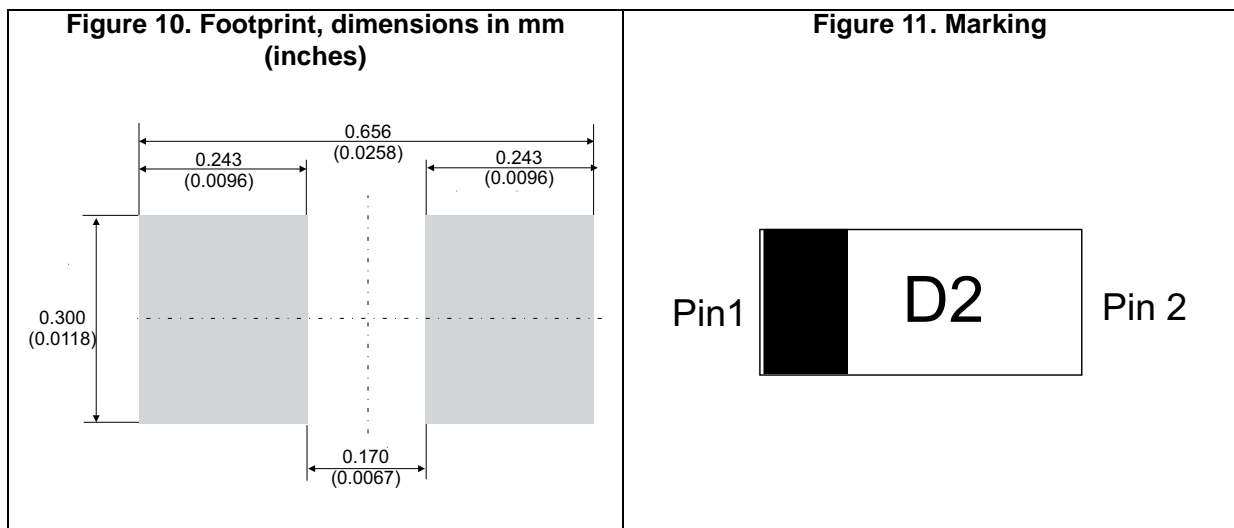

Table 3. 0201 package mechanical data

Ref.	Dimensions					
	Millimeters			Inches		
	Min.	Typ.	Max.	Min.	Typ.	Max.
A	0.23	0.28	0.33	0.0091	0.0110	0.0130
b1	0.20	0.25	0.30	0.0079	0.0098	0.0118
b2	0.20	0.25	0.30	0.0079	0.0098	0.0118
D	0.25	0.30	0.35	0.0099	0.0118	0.0138
E	0.55	0.60	0.65	0.0217	0.0236	0.0256
e		0.35			0.0138	
L1	0.13	0.18	0.23	0.0052	0.0071	0.0091
L2	0.14	0.19	0.24	0.0055	0.0075	0.0095



Note: Product marking may be rotated by 180° for assembly plant differentiation. In no case should this product marking be used to orient the component for its placement on a PCB. Only pin 1 mark is to be used for this purpose.

Figure 12. Tape and reel outline

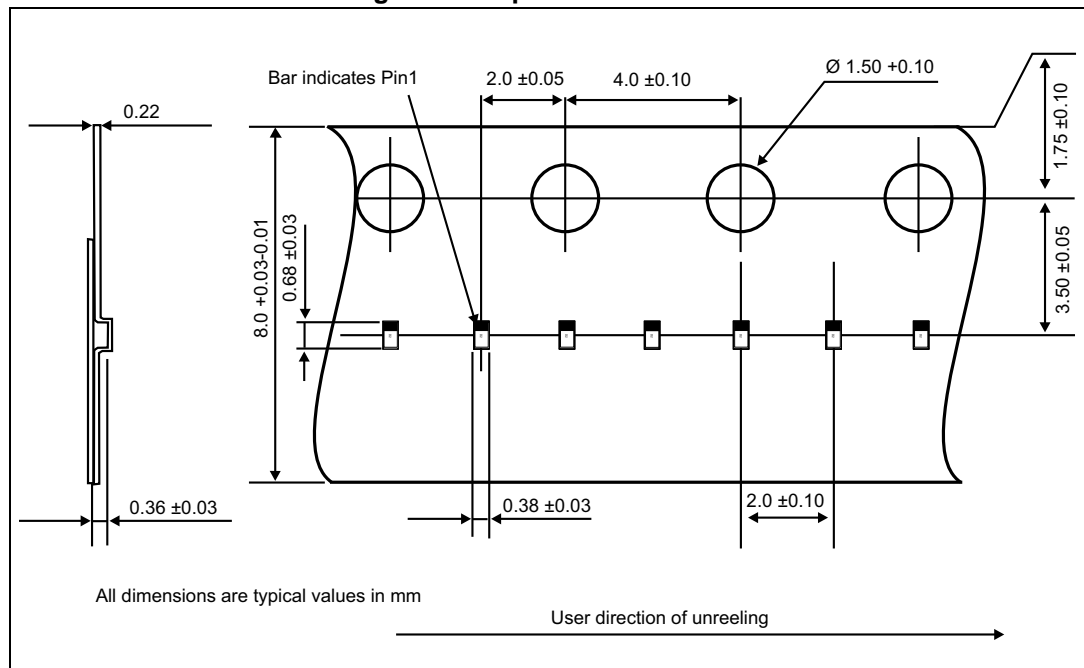

3 Recommendation on PCB assembly

3.1 Stencil opening design

1. General recommendations on stencil opening design
 - a) Stencil opening dimensions: L (Length), W (Width), T (Thickness).

Figure 13. Stencil opening dimensions

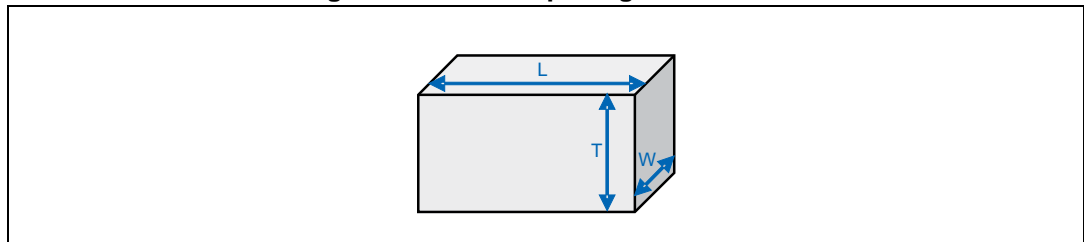

- b) General design rule
 - Stencil thickness (T) = 75 ~ 125 μm
 - Aspect Ratio = $\frac{W}{T} \geq 1.5$
 - Aspect Area = $\frac{L \times W}{2T(L + W)} \geq 0.66$

2. Recommended stencil window
 - a) Stencil opening thickness: 80 μm
 - b) Other dimensions: see [Figure 14](#)

Figure 14. Recommended stencil window position, stencil opening thickness: 80 μm

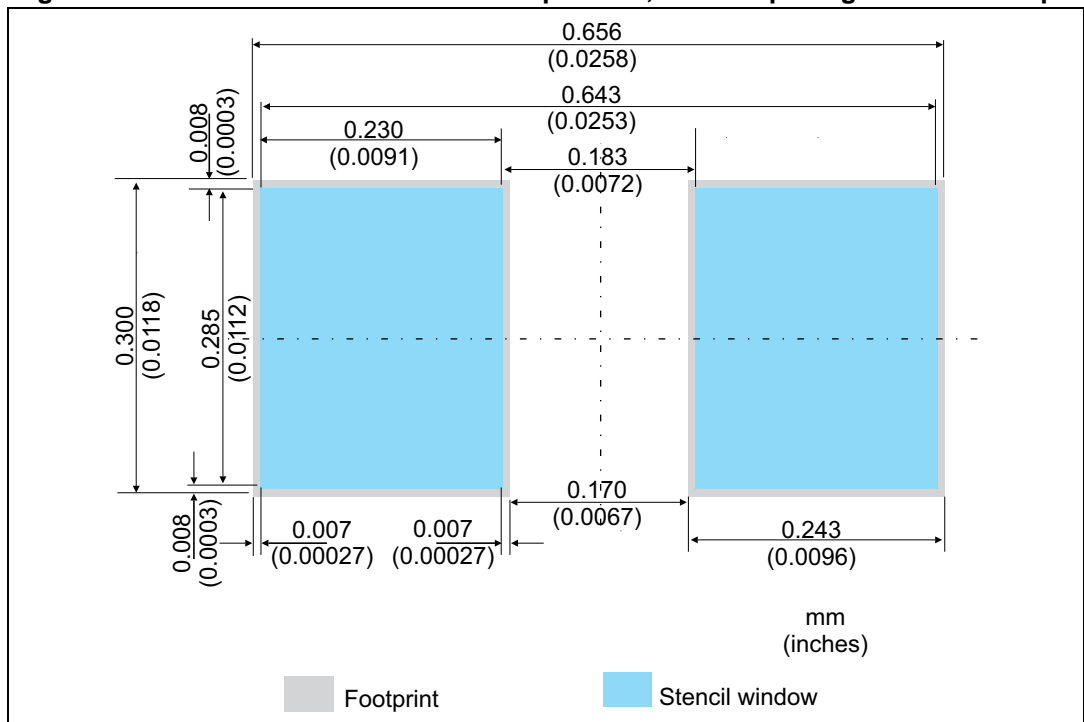

3.2 Solder paste

1. Halide-free flux qualification ROL0 according to ANSI/J-STD-004.
2. "No clean" solder paste is recommended.
3. Offers a high tack force to resist component displacement during PCB movement.
4. Use solder paste with fine particles: Type 4 (powder particle size is 20-45 μm).

3.3 Placement

1. Manual positioning is not recommended.
2. It is recommended to use the lead recognition capabilities of the placement system, not the outline centering
3. Standard tolerance of ± 0.05 mm is recommended.
4. 1.0 N placement force is recommended. Too much placement force can lead to squeezed out solder paste and cause solder joints to short. Too low placement force can lead to insufficient contact between package and solder paste that could cause open solder joints or badly centered packages.
5. To improve the package placement accuracy, a bottom side optical control should be performed with a high resolution tool.
6. For assembly, a perfect supporting of the PCB (all the more on flexible PCB) is recommended during solder paste printing, pick and place and reflow soldering by using optimized tools.

3.4 PCB design preference

1. To control the solder paste amount, the closed via is recommended instead of open vias.
2. The position of tracks and open vias in the solder area should be well balanced. A symmetrical layout is recommended, to avoid any tilt phenomena caused by asymmetrical solder paste due to solder flow away.

3.5 Reflow profile

Figure 15. ST ECOPACK® recommended soldering reflow profile for PCB mounting

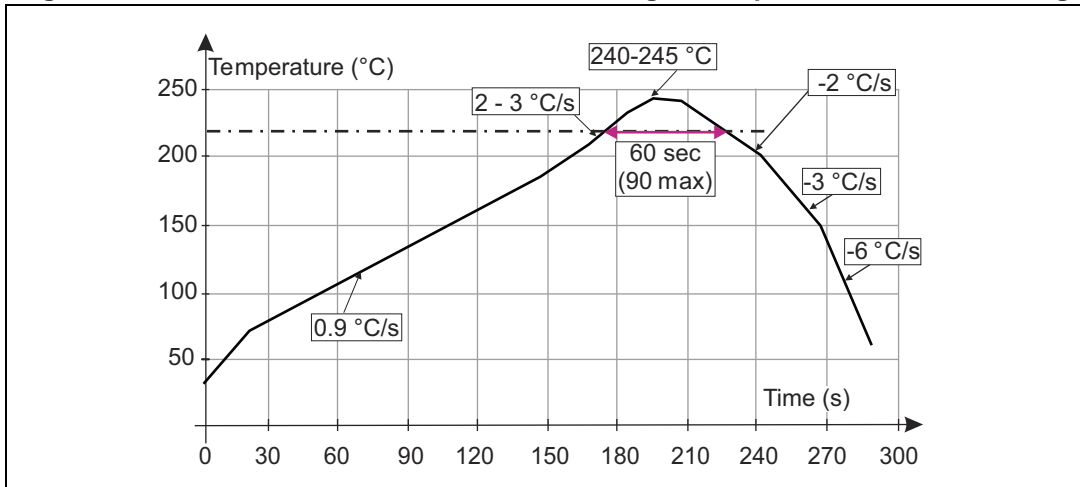

Note: Minimize air convection currents in the reflow oven to avoid component movement. Maximum soldering profile corresponds to the latest IPC/JEDEC J-STD-020.

4 Ordering information

Figure 16. Ordering information scheme

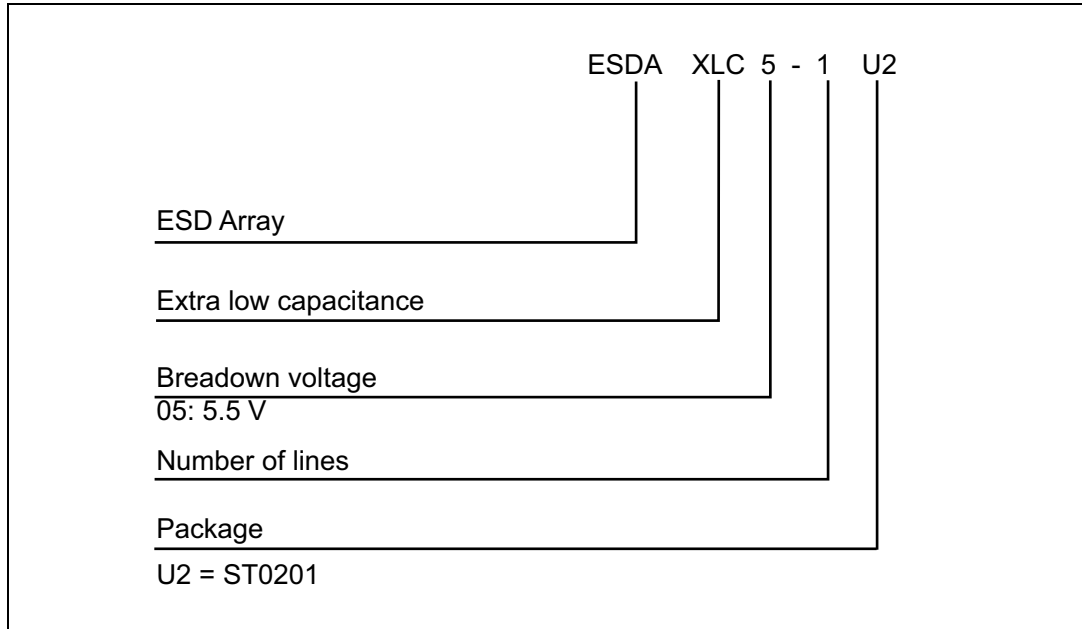

Table 4. Ordering information

Order code	Marking	Weight	Base qty	Delivery mode
ESDAXLC5-1U2	D2 ⁽¹⁾	0.124 mg	15000	Tape and reel

1. The marking can be rotated by 180° to differentiate assembly location

5 Revision history

Table 5. Document revision history

Date	Revision	Changes
25-Jan-2016	1	Initial release.

IMPORTANT NOTICE – PLEASE READ CAREFULLY

STMicroelectronics NV and its subsidiaries ("ST") reserve the right to make changes, corrections, enhancements, modifications, and improvements to ST products and/or to this document at any time without notice. Purchasers should obtain the latest relevant information on ST products before placing orders. ST products are sold pursuant to ST's terms and conditions of sale in place at the time of order acknowledgement.

Purchasers are solely responsible for the choice, selection, and use of ST products and ST assumes no liability for application assistance or the design of Purchasers' products.

No license, express or implied, to any intellectual property right is granted by ST herein.

Resale of ST products with provisions different from the information set forth herein shall void any warranty granted by ST for such product.

ST and the ST logo are trademarks of ST. All other product or service names are the property of their respective owners.

Information in this document supersedes and replaces information previously supplied in any prior versions of this document.

© 2016 STMicroelectronics – All rights reserved



Компания «ЭлектроПласт» предлагает заключение долгосрочных отношений при поставках импортных электронных компонентов на взаимовыгодных условиях!

Наши преимущества:

- Оперативные поставки широкого спектра электронных компонентов отечественного и импортного производства напрямую от производителей и с крупнейших мировых складов;
- Поставка более 17-ти миллионов наименований электронных компонентов;
- Поставка сложных, дефицитных, либо снятых с производства позиций;
- Оперативные сроки поставки под заказ (от 5 рабочих дней);
- Экспресс доставка в любую точку России;
- Техническая поддержка проекта, помощь в подборе аналогов, поставка прототипов;
- Система менеджмента качества сертифицирована по Международному стандарту ISO 9001;
- Лицензия ФСБ на осуществление работ с использованием сведений, составляющих государственную тайну;
- Поставка специализированных компонентов (Xilinx, Altera, Analog Devices, Intersil, Interpoint, Microsemi, Aeroflex, Peregrine, Syfer, Eurofarad, Texas Instrument, Miteq, Cobham, E2V, MA-COM, Hittite, Mini-Circuits, General Dynamics и др.);

Помимо этого, одним из направлений компании «ЭлектроПласт» является направление «Источники питания». Мы предлагаем Вам помощь Конструкторского отдела:

- Подбор оптимального решения, техническое обоснование при выборе компонента;
- Подбор аналогов;
- Консультации по применению компонента;
- Поставка образцов и прототипов;
- Техническая поддержка проекта;
- Защита от снятия компонента с производства.



Как с нами связаться

Телефон: 8 (812) 309 58 32 (многоканальный)

Факс: 8 (812) 320-02-42

Электронная почта: org@eplast1.ru

Адрес: 198099, г. Санкт-Петербург, ул. Калинина, дом 2, корпус 4, литера А.