

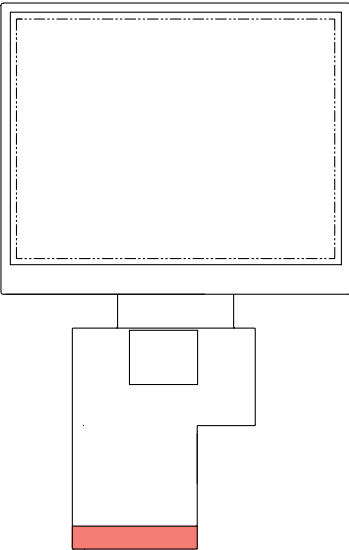

PRODUCT SPECIFICATION

HDA350-LG

QVGA, TFT COLOR GRAPHICS
LCD DISPLAY MODULE



HANTRONIX, INC. 10080 BUBB RD. CUPERTINO, CA 95014	Q.A.: Z.W.	HDA350-LG	SHEET 1 OF 22 DATE: 6/28/17
--	---------------	-----------	--------------------------------

1. General Description and Features

HDA350-LG is a TM (Transmissive) type color active matrix TFT (Thin Film Transistor) liquid crystal display (LCD) that uses amorphous silicon TFT as a switching device. This model is composed of a TFT-LCD module, a driver circuit and a back-light unit. The resolution of a 3.5" contains 320RGBx240 dots and can display up to 16.7M colors.

1.1 Features

- QVGA(320 x 240 pixels) resolution.
- Display in 16.7M colors.
- On-chip voltage generator.
- SYNC mode is supported for digital RGB input data format.
- RoHS Compliance

1.2 LCD Module

Item	Specification	Unit
Screen Size	3.5 inches	Diagonal
Display Resolution	320 x RGB x 240	Dot
Dot Pitch	0.073 (H) x 0.219 (V)	mm
Active Area	70.08 (H) x 52.56 (V)	mm
Outline Dimension	76.9 (W) x 63.9 (H) x 3.3 (D)	mm
Display Mode	Normally white/Transmissive	--
Pixel Arrangement	RGB-Stripe	--
Surface Treatment	Anti-glare (AG)	--
Display Color	16.7M	--
Viewing Direction	6 o'clock (Gray Inversion)	--
Input Interface	Digital 8-bits color RGB	--
Color Gamut	NTSC 60%	--

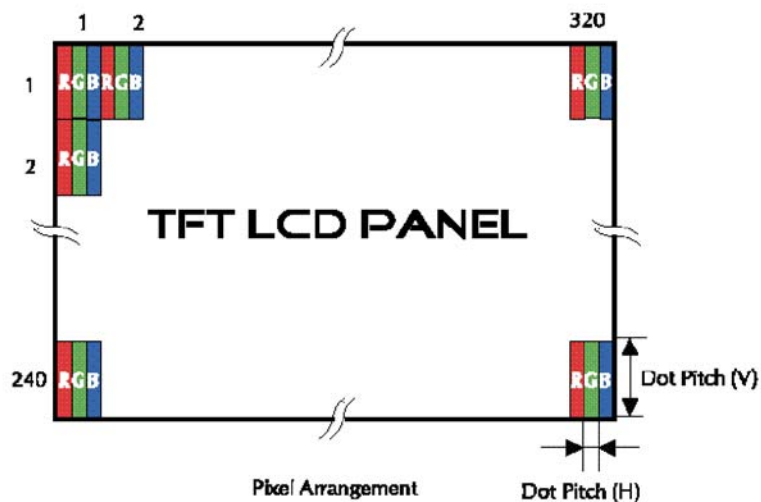

HANTRONIX, INC.
10080 BUBB RD.
CUPERTINO, CA 95014

Q.A.:
Z.W.

HDA350-LG

SHEET 2 OF 22

DATE: 6/28/17

2. Mechanical Information

Item		Min.	Typ.	Max.	Unit	Note
Module Size	Horizontal (H)	--	76.90	--	mm	--
	Vertical (V)	--	63.90	--	mm	(1)
	Thickness (T)	--	3.30	--	mm	(2)
Weight		--	32	--	g	--

Note (1) Not include FPC.

Refer to the Outline Dimension for further information.

3. Electrical Specifications

3.1 Absolute Max. Ratings

3.1.1 Absolute Ratings of Environment

If the operating condition exceeds the following absolute maximum ratings, the TFT LCD module may be damaged permanently.

($T_a = 25 \pm 2^\circ\text{C}$, $V_{SS} = \text{GND} = 0$)

Item	Symbol	Min.	Max.	Unit	Note
Storage temperature	T_{STG}	-30	80	$^\circ\text{C}$	(1)
Operating temperature	T_{OPR}	-20	70	$^\circ\text{C}$	(1,2,3)

Note (1) 95 % RH Max. ($40^\circ\text{C} \geq T_a$). Maximum wet-bulb temperature at 39°C or less. ($T_a > 40^\circ\text{C}$)
No condensation.

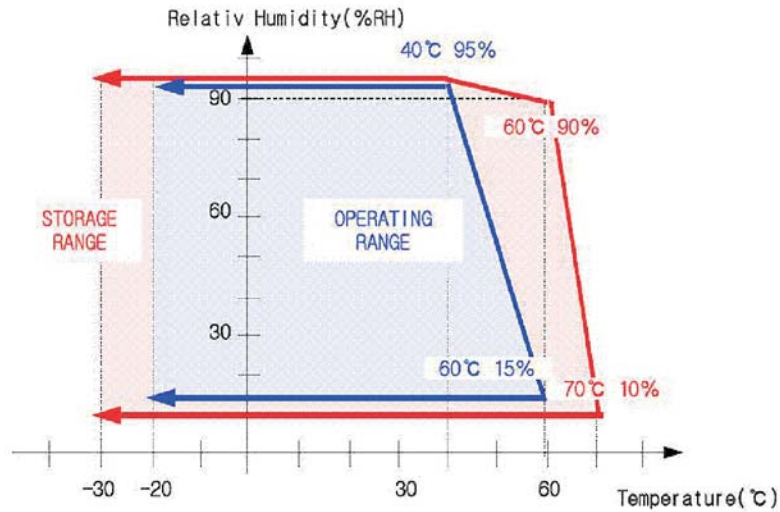

Note (2) In case of below 0° , the response time of liquid crystal (LC) becomes slower and the color of panel becomes darker than normal one. Level of retardation depends on temperature, because of LC's character

Note (3) Only operation is guaranteed at operating temperature. Contrast, response time, another display quality are evaluated at $+25^\circ\text{C}$.

3.2 Electrical Absolute Rating

3.2.1 TFT-LCD Module

(Voltage Referenced to VSS)

Item	Symbol	Value		Unit	Condition
		Min.	Max.		
Digital Power Supply Voltage	V _{CC}	VSS-0.3	5.0	V	--

3.2.2 Back-Light Unit

(T_a=25±2°C)

Item	Symbol	Min.	Max.	Unit	Note
Forward current	I _f	--	(30)	mA	(1)
Reverse voltage	V _R	--	(30)	V	(1)

Note (1) Permanent damage to the device may occur if maximum values are exceeded or reverse voltage is loaded. Functional operation should be restricted to the conditions described under normal operating conditions.

4 Electrical Characteristics

4.1 TFT-LCD Module (DC Characteristics)

Item	Symbol	Value			Unit	Note
		Min.	Typ.	Max.		
Digital Power Supply Voltage	V_{CC}	2.5	3.3	3.6	V	
Input High Threshold Voltage	V_{IH}	$0.8 V_{CC}$	-	V_{CC}	V	
Input Low Threshold Voltage	V_{IL}	0	-	$0.2 V_{CC}$	V	
Power Supply Current	I_{CC}	-	(15.6)	(22.0)	mA	(1)
Power Consumption	P_L	-	51.48	72.6	mW	(1)

Note (1) The specified power consumption is under the conditions at $V_{CC}=3.3V$, $F_V=60Hz$, whereas a Power dissipation check pattern below is displayed.

Black Pattern / 0 Gray

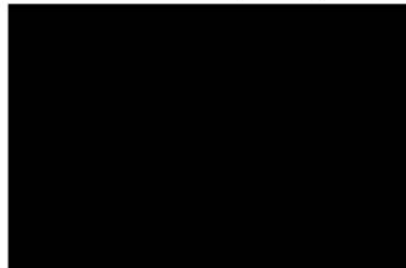

Active Area

4.2 Backlight Unit

The back-light system is an edge-lighting type with six white LEDs (Light Emitting Diode).

(Ta=25±2°C)

Item	Symbol	Value			Unit	Condition
		Min.	Typ.	Max.		
LED Voltage	VL	-	(18.6)		V	
LED Current	IL	-	(20)	-	mA	
Power Consumption	P _{BL}	-	(372)	-	mW	
LED Life Time(25°C)	-	(50000)	-	-	hr	

Note (1) Six LEDs serial type.

(2) Where $I_B = 20\text{mA}$, $V_F = 18.6$, $P_{BL} = V_F \times I_B$

5 Block Diagram

TFT-LCD Module with Backlight Unit

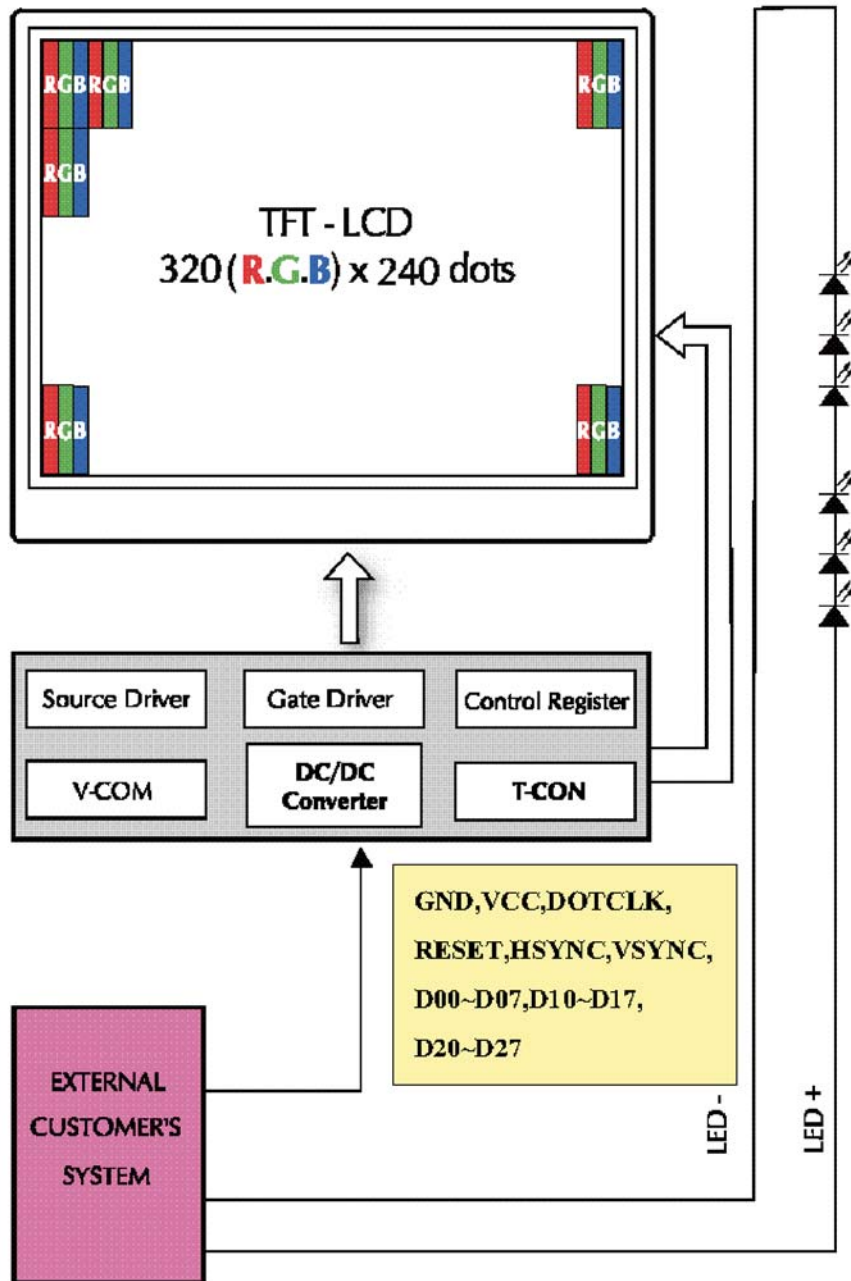

6 Input Terminal Pin Assignment

6.1 Pin Assignment (LCD)

Pin No.	Symbol	I/O	Function	Remark
1	LED_K	I	Backlight LED Ground	
2	LED_K	I	Backlight LED Ground	
3	LED_A	I	Backlight LED Power	
4	LED_A	I	Backlight LED Power	
5	N/C	I	Not Connection	
6	N/C	I	Not Connection	
7	N/C	I	Not Connection	
8	RESET	I	Hardware Reset	
9	NC	I	Not Connection	
10	NC	I	Not Connection	
11	NC	--	Not Connection	
12	D20	I	Blue Data (LSB)	
13	D21	I	Blue Data	
14	D22	I	Blue Data	
15	D23	I	Blue Data	
16	D24	I	Blue Data	
17	D25	I	Blue Data	
18	D26	I	Blue Data	
19	D27	I	Blue Data (MSB)	
20	D10	I	Green Data (LSB)	
21	D11	I	Green Data	
22	D12	I	Green Data	
23	D13	I	Green Data	
24	D14	I	Green Data	
25	D15	I	Green Data	
26	D16	I	Green Data	
27	D17	I	Green Data (MSB)	
28	D00	I	Red Data (LSB)	
29	D01	I	Red Data	
30	D02	I	Red Data	
31	D03	I	Red Data	
32	D04	I	Red Data	
33	D05	I	Red Data	

34	D06	I	Red Data	
35	D07	I	Red Data (MSB)	
36	H _{SYNC}	I	Horizontal Sync Input	
37	V _{SYNC}	I	Vertical Sync Input	
38	D _{OTCLK}	I	Dot Data Clock	
39	N/C	I	Not Connection	
40	N/C	I	Not Connection	
41	VCC	I	For system power supply.	
42	VCC	I	For system power supply.	
43	N/C	I	Not Connection	
44	N/C	I	Not Connection	
45	N/C	I	Not Connection	
46	N/C	I	Not Connection	
47	N/C	I	Not Connection	
48	N/C	I	Not Connection	
49	N/C	I	Not Connection	
50	N/C	I	Not Connection	
51	N/C	I	Not Connection	
52	N/C	I	Not Connection	
53	GND	I	Ground	
54	GND	I	Ground	

7 Optical Characteristics

The following items are measured under stable conditions. The optical characteristics should be measured in a dark room or equivalent state with the methods shown in Note (1).

Measuring equipment: BM-5A, BM-7,

(Ta=25±2°C)

Item	Symbol	Condition	Min	Type	Max	Unit	Note	
Brightness	--	$\theta=0^\circ$ Normal Viewing Angle	300	350	--	cd/m ²	--	
Response time	T _R		--	15	20	ms	--	
	T _F		--	35	50	ms		
Brightness uniformity	B _{UNI}		80	-	-	%		
Contrast ratio	CR		300	450	--	--	--	
Color Chromaticity (CIE1931)	Red		R _X	(0.590)	(0.640)	(0.690)	--	--
			R _Y	(0.294)	(0.344)	(0.394)		
	Green		G _X	(0.248)	(0.298)	(0.348)	--	
			G _Y	(0.532)	(0.583)	(0.633)		
	Blue		B _X	(0.090)	(0.140)	(0.190)	--	
		B _Y	(0.080)	(0.130)	(0.180)			
	White	W _X	(0.262)	(0.312)	(0.362)	--		
		W _Y	(0.299)	(0.349)	(0.399)			
Viewing Angle (6H)	Hor.	θ_R	50	(60)	--	Degree	--	
		θ_L	50	(60)	--			
	Ver.	ϕ_H	40	(50)	--			
		ϕ_L	50	(60)	--			

HANTRONIX, INC.
10080 BUBB RD.
CUPERTINO, CA 95014

Q.A.:
Z.W.

HDA350-LG

SHEET 11 OF 22

DATE:
6/28/17

a. Test equipment setup

After stabilizing and leaving the panel alone shall be warmed up for the stable operation of LCM, the measurement should be executed. Measurement should be executed in a stable, windless, and dark room. Optical specifications are measured by Topcon BM-7(fast) with a viewing angle of 2° at a distance of 50cm and normal direction.

b. Definition of response time: Tr and Tf

The response time is defined as the following figure and shall be measured by switching the input signal for "black" and "white".

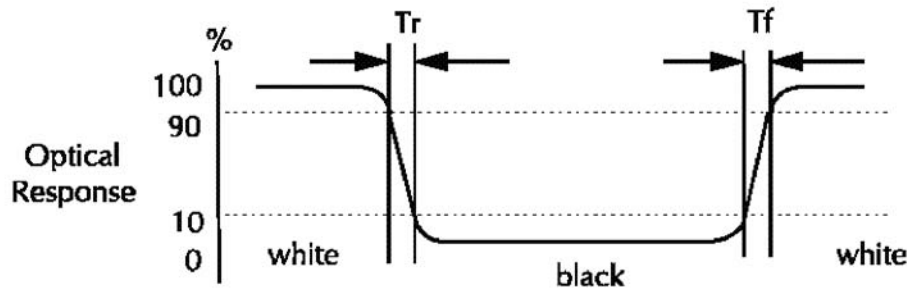

c. Definition of contrast ratio:

Brightness measured when LCD is at "white state"

$$\text{Contrast Ratio (CR)} = \frac{\text{Brightness measured when LCD is at "white state"}}{\text{Brightness measured when LCD is at "black state"}}$$

Brightness measured when LCD is at "black state"

d. Measured at the center area of the panel when all the input terminals of LCD panel are electrically opened.

HANTRONIX, INC. 10080 BUBB RD. CUPERTINO, CA 95014	Q.A.: Z.W.	HDA350-LG	SHEET 12 OF 22 <hr/> DATE: 6/28/17
--	-------------------	-----------	---------------------------------------

e. View Angle

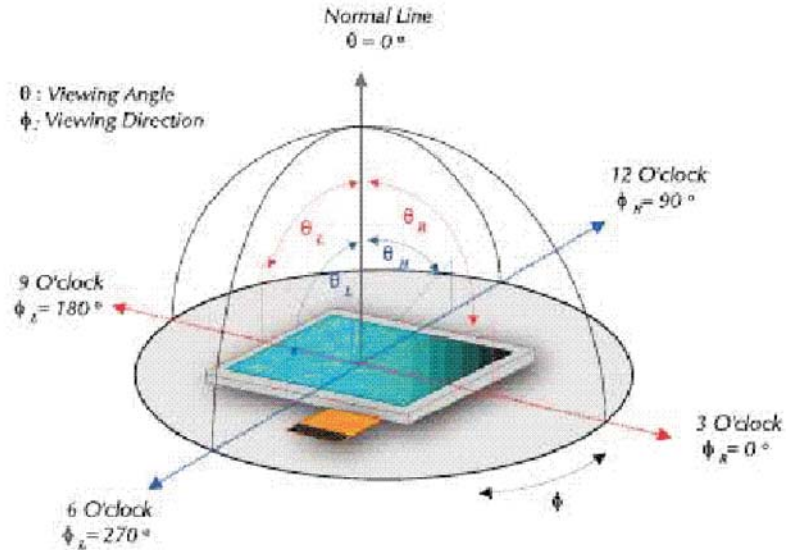

f. Definition of Luminance of White: Luminance of white at the center points

Light Source of Back-Light Unit	LED Type
---------------------------------	----------

g. Definition of White Uniformity

$$\text{White Uniformity} = \frac{\text{Min. luminance of white among 9-points}}{\text{Max. luminance of white among 9-points}}$$

h. The definition of Color Gamut -Color Chromaticity CIE 1931

Color coordinate of white & red, green, blue at center point.

$$\text{Color Gamut : NTSC(\%)} = \left(\frac{\text{RGB Triangle Area}}{\text{NTSC Triangle Area}} \right) \times 100$$

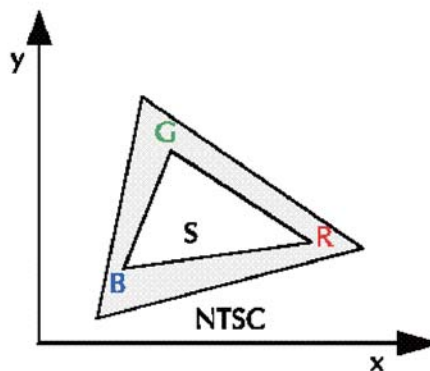

HANTRONIX, INC. 10080 BUBB RD. CUPERTINO, CA 95014	Q.A.:	HDA350-LG	SHEET 13 OF 22
	Z.W.		DATE: 6/28/17

8 Basic Display Color and Gray Scale

	Color & Gray Scale	Data Signal																							
		D07	D06	D05	D04	D03	D02	D01	D00	D17	D16	D15	D14	D13	D12	D11	D10	D27	D26	D25	D24	D23	D22	D21	D20
Basic Color	Black	0	0	0	0	0	0	0	0	0	0	0	0	0	0	0	0	0	0	0	0	0	0	0	
	Red	1	1	1	1	1	1	1	1	0	0	0	0	0	0	0	0	0	0	0	0	0	0	0	
	Green	0	0	0	0	0	0	0	0	1	1	1	1	1	1	1	1	0	0	0	0	0	0	0	
	Blue	0	0	0	0	0	0	0	0	0	0	0	0	0	0	0	0	1	1	1	1	1	1	1	
	Cyan	0	0	0	0	0	0	0	0	1	1	1	1	1	1	1	1	1	1	1	1	1	1	1	
	Magenta	1	1	1	1	1	1	1	1	0	0	0	0	0	0	0	0	1	1	1	1	1	1	1	
	Yellow	1	1	1	1	1	1	1	1	1	1	1	1	1	1	1	1	0	0	0	0	0	0	0	
	White	1	1	1	1	1	1	1	1	1	1	1	1	1	1	1	1	1	1	1	1	1	1	1	
Red	Black	0	0	0	0	0	0	0	0	0	0	0	0	0	0	0	0	0	0	0	0	0	0		
	Red(1)	0	0	0	0	0	0	0	1	0	0	0	0	0	0	0	0	0	0	0	0	0	0		
	Red(2)	0	0	0	0	0	0	1	0	0	0	0	0	0	0	0	0	0	0	0	0	0	0		
	:	:	:	:	:	:	:	:	:	:	:	:	:	:	:	:	:	:	:	:	:	:	:		
	Red(127)	0	1	1	1	1	1	1	1	0	0	0	0	0	0	0	0	0	0	0	0	0	0		
	:	:	:	:	:	:	:	:	:	:	:	:	:	:	:	:	:	:	:	:	:	:	:		
	Red(254)	1	1	1	1	1	1	1	0	0	0	0	0	0	0	0	0	0	0	0	0	0	0		
	Red(255)	1	1	1	1	1	1	1	1	0	0	0	0	0	0	0	0	0	0	0	0	0	0		
Green	Black	0	0	0	0	0	0	0	0	0	0	0	0	0	0	0	0	0	0	0	0	0	0		
	Green(1)	0	0	0	0	0	0	0	0	0	0	0	0	0	0	0	1	0	0	0	0	0	0		
	Green(2)	0	0	0	0	0	0	0	0	0	0	0	0	0	0	1	0	0	0	0	0	0	0		
	:	:	:	:	:	:	:	:	:	:	:	:	:	:	:	:	:	:	:	:	:	:	:		
	Green(127)	0	0	0	0	0	0	0	0	0	1	1	1	1	1	1	1	0	0	0	0	0	0		
	:	:	:	:	:	:	:	:	:	:	:	:	:	:	:	:	:	:	:	:	:	:	:		
	Green(254)	0	0	0	0	0	0	0	0	1	1	1	1	1	1	1	0	0	0	0	0	0	0		
	Green(255)	0	0	0	0	0	0	0	0	1	1	1	1	1	1	1	1	0	0	0	0	0	0		
Blue	Black	0	0	0	0	0	0	0	0	0	0	0	0	0	0	0	0	0	0	0	0	0	0		
	Blue(1)	0	0	0	0	0	0	0	0	0	0	0	0	0	0	0	0	0	0	0	0	0	1		
	Blue(2)	0	0	0	0	0	0	0	0	0	0	0	0	0	0	0	0	0	0	0	0	0	1		
	:	:	:	:	:	:	:	:	:	:	:	:	:	:	:	:	:	:	:	:	:	:	:		
	Blue(127)	0	0	0	0	0	0	0	0	0	0	0	0	0	0	0	0	1	1	1	1	1	1		
	:	:	:	:	:	:	:	:	:	:	:	:	:	:	:	:	:	:	:	:	:	:	:		
	Blue(254)	0	0	0	0	0	0	0	0	0	0	0	0	0	0	0	1	1	1	1	1	1	0		
	Blue(255)	0	0	0	0	0	0	0	0	0	0	0	0	0	0	0	1	1	1	1	1	1	1		

0 : Low level voltage, 1 :High level voltage

Each basic color can be displayed in 256 gray scales from 8 bit data signals. With the combination of total 24 bit data signals, the 16,777,216-color display can be achieved on the screen.

9 Interface Timing

9.1 Input Signal Characteristics

9.2.1 Digital Parallel RGB Interface (320*240 resolution)

Item	Symbol	Min.	Typ.	Max.	Unit	
DOTCLK Frequency	fDOTCLK	-	6.5	10	MHz	
DOTCLK Period	tDOTCLK	100	154	-	ns	
Horizontal Frequency (Line)	fH	-	14.9	22.35	KHz	
Vertical Frequency (Refresh)	fV	-	60	90	Hz	
Horizontal Back Porch	tHBP	-	68	-	tDOTCLK	
Horizontal Front Porch	tHFP	-	20	-	tDOTCLK	
Horizontal Data Start Point	tHBP	-	68	-	tDOTCLK	
Horizontal Blanking Period	tHBP + tHFP	-	88	-	tDOTCLK	
Horizontal Display Area	HDISP	-	320	-	tDOTCLK	
Horizontal Cycle	Hcycle	-	408	450	tDOTCLK	
Vertical Back Porch	tVBP	-	18	-	Lines	
Vertical Front Porch	tVFP	-	4	-	Lines	
Vertical Data Start Point	tVBP	-	18	-	Lines	
Vertical Blanking Period	tVBP + tVFP	-	22	-	Lines	
Vertical Display Area	NTSC	VDISP	-	240	-	Lines
	PAL			280(PALM=0)		
				288(PALM=1)		
Vertical Cycle	NTSC	Vcycle	-	262	350	Lines
	PAL			313		

9.2 Waveform

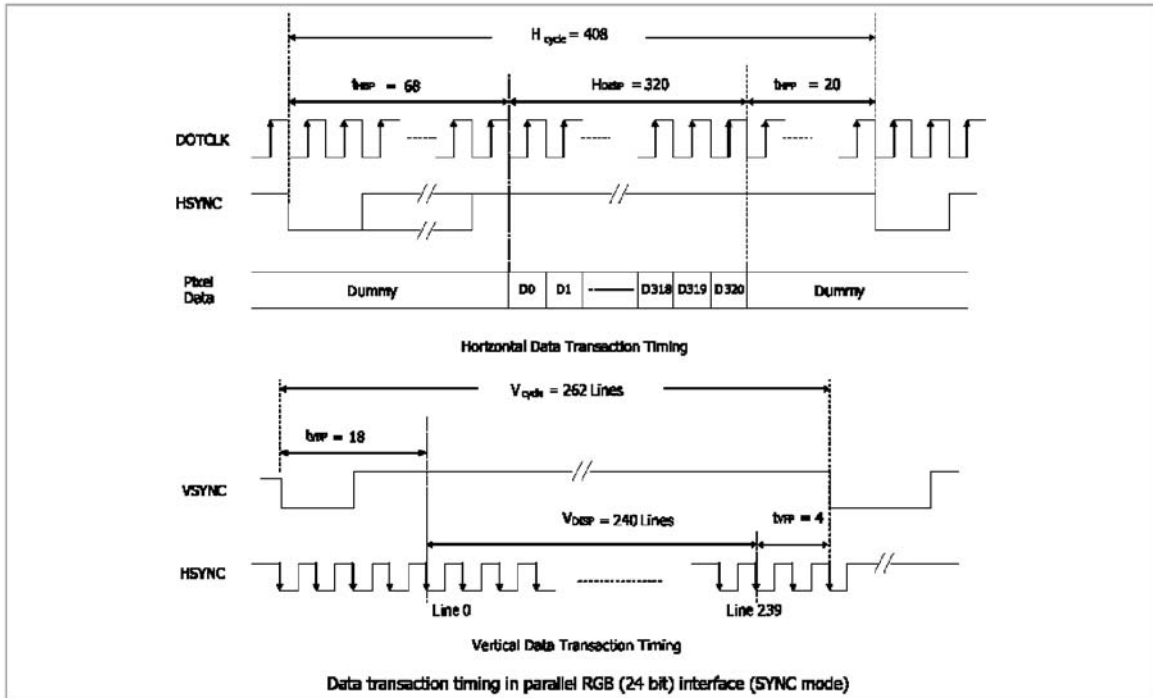

9.3 Power On/Off Sequence

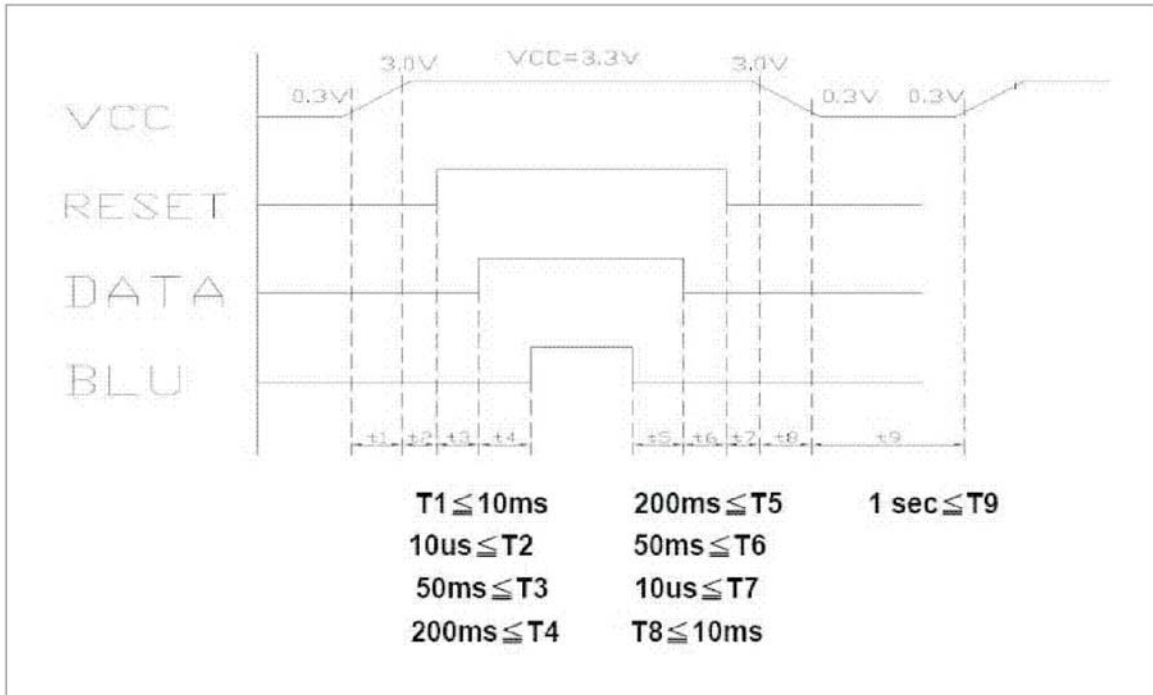

10 Reliability Condition for LCD

No change on display and in operation under the following test condition.

Condition: Unless otherwise specified, tests will be conducted under the following condition.

Temperature: 20±5°C

Humidity: 65±5%RH

Tests will be not conducted under functioning state.

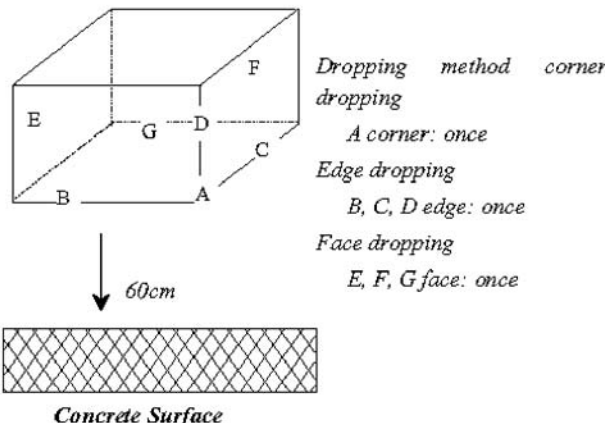
No.	Parameter	Condition	Notes
1	High Temperature Operating	70°C±2°C, 240hrs (Operation state)	--
2	Low Temperature Operating	-20°C±2°C, 240hrs (Operation state)	--
3	High Temperature Storage	80°C±2°C, 240hrs	--
4	Low Temperature Storage	-30°C±2°C, 240hrs	--
5	High Temperature and High Humidity Operation Test	60°C±2°C, 90%, 240hrs	--
6	Vibration Test	Total fixed amplitude: 1.5mm Vibration Frequency: 10~55Hz One cycle 60 seconds to 3 direction of X, Y, Z each 15 minutes.	--
7.	Drop Test	To be measured after dropping from 60cm high on the concrete surface in packing state. 	--

Notes: 1. No dew condensation to be observed.

2. The function test shall be conducted after 4 hours storage at the normal temperature and humidity after removed from the test chamber.

3. Vibration test will be conducted to the product itself without putting I in a container.

HANTRONIX, INC. 10080 BUBB RD. CUPERTINO, CA 95014	Q.A.: Z.W.	HDA350-LG	SHEET 17 OF 22
			DATE: 6/28/17

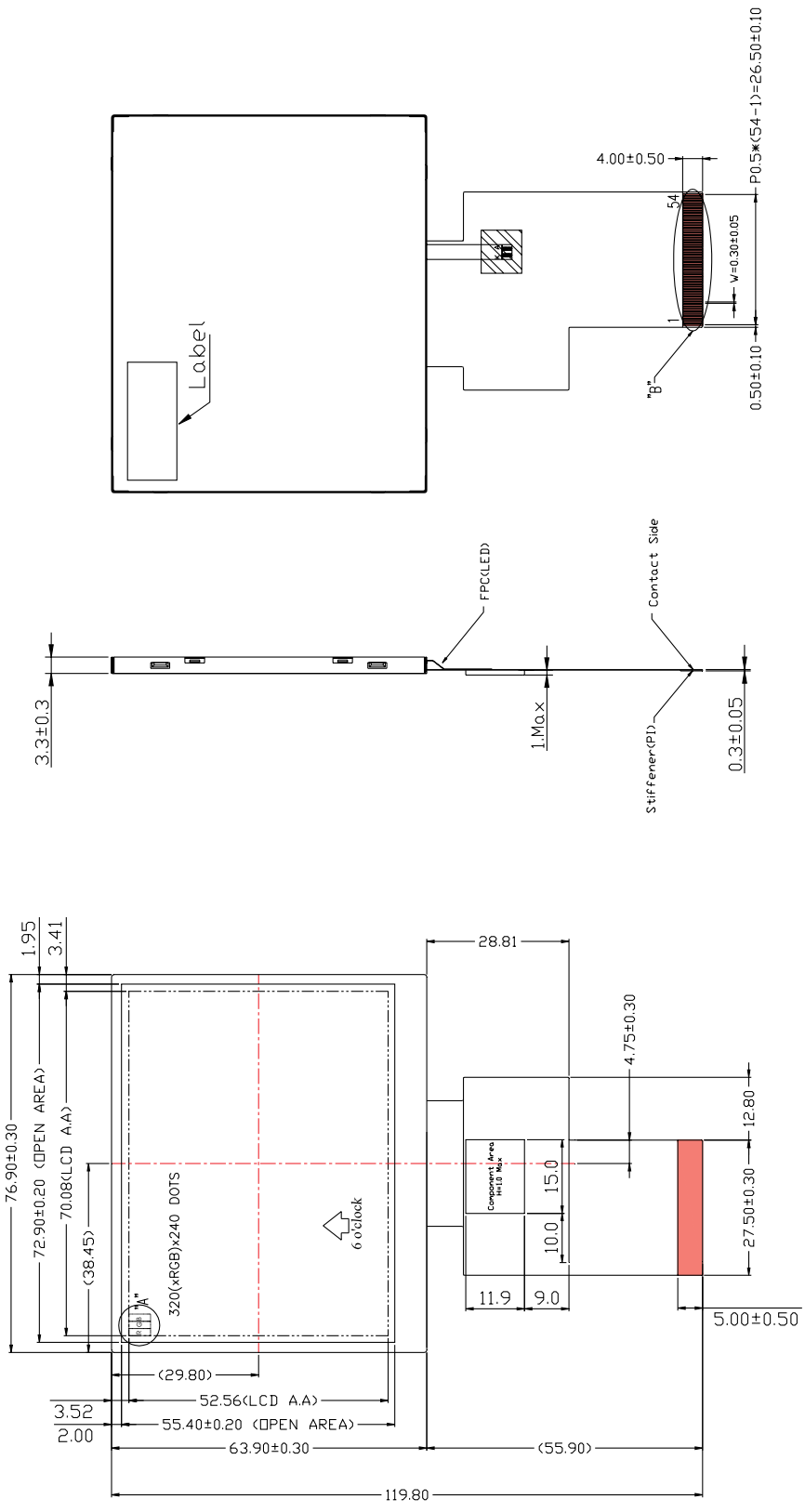

HANTRONIX, INC.
10080 BUBB RD.
CUPERTINO, CA 95014

Q.A.:
Z.W.

HDA350-LG

SHEET 18 OF 22

DATE:
6/28/17

DETAIL A
SCALE: 10:1

12 Incoming Inspection Standards

12.1 Inspection and Environment Conditions

12.1.1 Inspection Conditions:

- (1) Inspection Distance: 35 cm \pm 5cm
- (2) View Angle : Light-on Inspection Angle : $\pm 5^\circ$

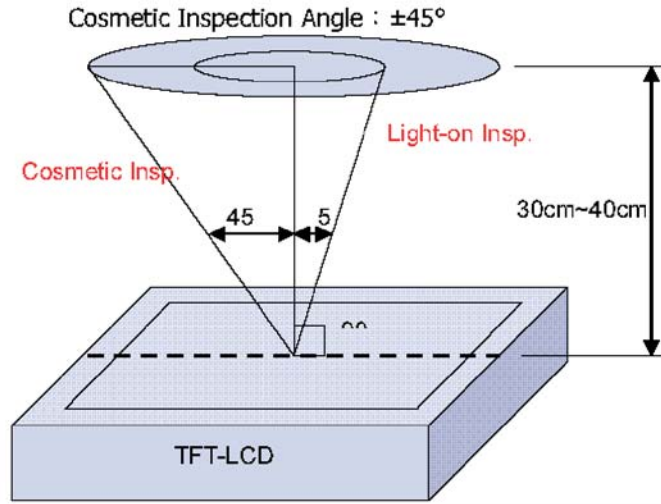

12.1.2 Environment Conditions:

Ambient Temperature		23°C \pm 5°C
Ambient Humidity		55 \pm 10%RH
Ambient Illumination	Cosmetic Inspection	more than 600 Lux
	Functional Inspection	300~500 Lux

12.1.3 Sampling Conditions:

- (1) Lot Size: Quantity of shipment lot per model

(2) Sampling Method:



Sampling Plan		MIL-STD-105E
		Normal Inspection, Single Sampling
		Level II
AQL	Major Defect	1.0%
	Minor Defect	1.5%

- (3) The classification of Major(MA) and Minor(MI) defects is shown as 3. Inspection Criteria.

HANTRONIX, INC. 10080 BUBB RD. CUPERTINO, CA 95014	Q.A.:	HDA350-LG	SHEET 19 OF 22
	Z.W.		DATE: 6/28/17

12.1.4 Inspection Criteria

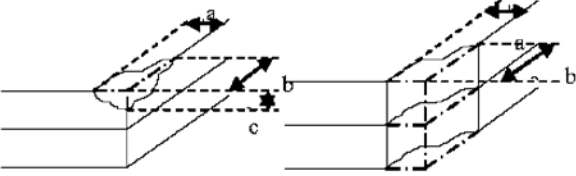
12.1.4.1 Cosmetic Inspection(Panel):

Item	Judgment Criteria	Classification
Chipping on Panel	 <p>$a \leq 3.0\text{mm}$, $b \leq 3.0\text{mm}$, $c \leq t$ (Bottom glass thickness)</p>	MA
Scratch on Panel *Note-2	<p>$W \leq 0.05\text{mm}$ or $L < 5\text{mm}$: Ignored</p> <p>$0.05\text{mm} < W \leq 0.1\text{mm}$ and $L \leq 5\text{mm}$: $N \leq 5$</p> <p>$W > 0.1\text{mm}$ or $L > 5\text{mm}$: Not allowed</p>	MI
Bubble or Dent on Panel *Note-3	<p>$D \leq 0.2\text{mm}$: Ignored</p> <p>$0.2\text{mm} < D \leq 0.3\text{mm}$: $N \leq 5$</p> <p>$D > 0.3\text{mm}$: Not allowed</p>	MI
Panel Crack	 <p>Not Allowed crack</p>	MA
Bezel Deformation	Obvious deformation is not allowed.	MI
Bezel Oxidation	Not allowed if it rusts continuously over 1 cm (It is out of warranty with rusted tin plate)	MI
Bezel Scratch	$L \leq 20\text{mm}$, $W \leq 0.2$, $N \leq 3$	MI
Metal Squash Dent /Flange(Front Side)	$D(W) \leq 1, L \leq 3, N \leq 3;$	MI
B/L High Voltage Wire Denudation	Not allowed	MA
Polarizer flaw or leak out resin	Defect is defined as the active area.	MI
Outline Dimension	Must in Spec, refer to related product spec.	MI

HANTRONIX, INC.
10080 BUBB RD.
CUPERTINO, CA 95014

Q.A.:
Z.W.

HDA350-LG

SHEET 20 OF 22

DATE: 6/28/17

12.1.4.2 Functional Inspection:

Item	Judgment Criteria			Classification	
	Area(Note1)	I	O		
Point Defect	Bright dot	Random	2		MI
		2 dots adjacent	0	0	
		3 dots adjacent or more	0	0	
	Dark dot	Random	3		
		2 dots adjacent	0		
		3 dots adjacent or more	0	0	
	Total Dot Defect		5		
	Distance	Distance between Bright and Bright dot	$L \geq 5\text{mm}$		
		Distance between Bright and Dark dot	$L \geq 5\text{mm}$		
		Distance between Dark dot	$L \geq 5\text{mm}$		
(1) It is defined as Point Defect if defect area $> 0.5\text{dot}$ (2) It is ignored if defect area $\leq 0.5\text{dot}$ (3) Weak point defect will be defined as Bright Dot if it can be observed through ND filter 5% (Full Screen Black Inspection)					
Line Defect	Obvious vertical or horizontal line defect is not allowed.			MA	
Mura	Not allowed if it can be observed through ND Filter 5 %			MI	
Foreign Material in spot shape *Note-3	$D \leq 0.2\text{mm}$: Ignored $0.2\text{mm} < D \leq 0.5\text{mm}$: $N \leq 8$ $D > 0.5\text{mm}$: Not allowed			MI	
Foreign Material in line or spiral shape *Note-4	$W \leq 0.05\text{mm}$ or $L \leq 5\text{mm}$: Ignored $0.05\text{mm} < W \leq 0.2\text{mm}$ and $L 1.0\text{mm} \leq 5\text{mm}$: $N \leq 8$ $W > 0.2\text{mm}$ or $L > 5\text{mm}$: Not allowed			MI	
Display Function Abnormal	No Malfunction can be allowed			MA	

HANTRONIX, INC.
10080 BUBB RD.
CUPERTINO, CA 95014

Q.A.:
Z.W.

HDA350-LG

SHEET 21 OF 22

DATE: 6/28/17

Note-1 : I/O Area Definition

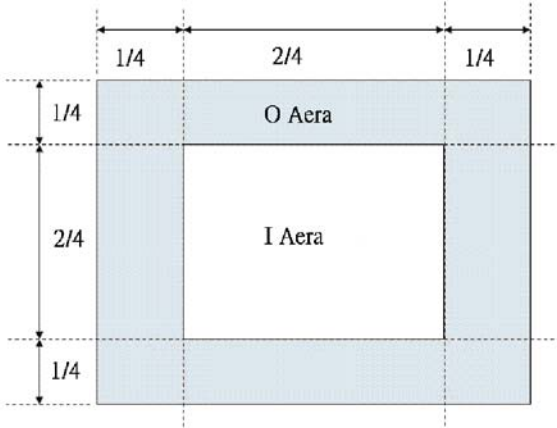

Note-2 : Polarizer Scratch

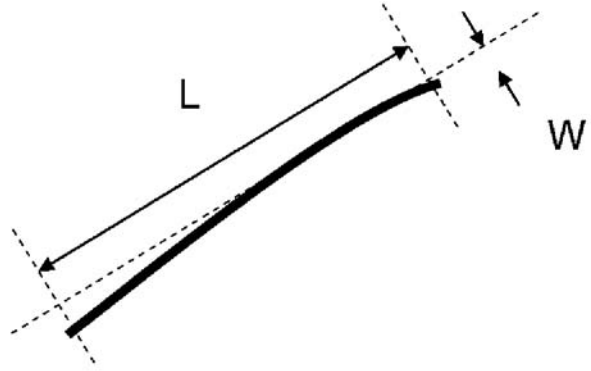

Note-3 : Spot Foreign Material
($W \geq L / 4$)

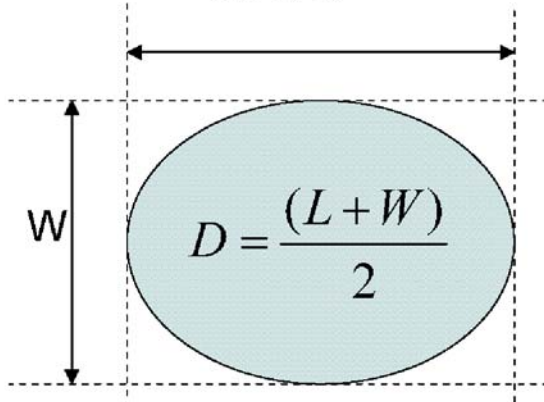

Note-4 : Line or Spiral Foreign Material
($W < L / 4$)

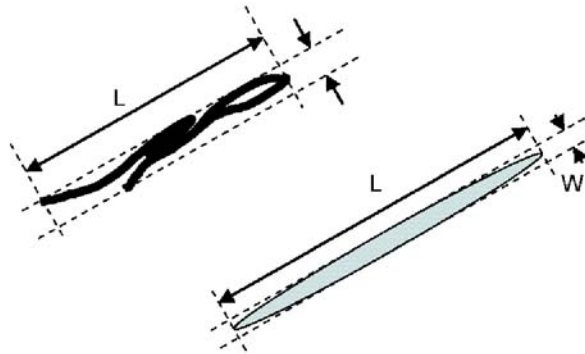



Компания «ЭлектроПласт» предлагает заключение долгосрочных отношений при поставках импортных электронных компонентов на взаимовыгодных условиях!

Наши преимущества:

- Оперативные поставки широкого спектра электронных компонентов отечественного и импортного производства напрямую от производителей и с крупнейших мировых складов;
- Поставка более 17-ти миллионов наименований электронных компонентов;
- Поставка сложных, дефицитных, либо снятых с производства позиций;
- Оперативные сроки поставки под заказ (от 5 рабочих дней);
- Экспресс доставка в любую точку России;
- Техническая поддержка проекта, помощь в подборе аналогов, поставка прототипов;
- Система менеджмента качества сертифицирована по Международному стандарту ISO 9001;
- Лицензия ФСБ на осуществление работ с использованием сведений, составляющих государственную тайну;
- Поставка специализированных компонентов (Xilinx, Altera, Analog Devices, Intersil, Interpoint, Microsemi, Aeroflex, Peregrine, Syfer, Eurofarad, Texas Instrument, Miteq, Cobham, E2V, MA-COM, Hittite, Mini-Circuits, General Dynamics и др.);

Помимо этого, одним из направлений компании «ЭлектроПласт» является направление «Источники питания». Мы предлагаем Вам помощь Конструкторского отдела:

- Подбор оптимального решения, техническое обоснование при выборе компонента;
- Подбор аналогов;
- Консультации по применению компонента;
- Поставка образцов и прототипов;
- Техническая поддержка проекта;
- Защита от снятия компонента с производства.



Как с нами связаться

Телефон: 8 (812) 309 58 32 (многоканальный)

Факс: 8 (812) 320-02-42

Электронная почта: org@eplast1.ru

Адрес: 198099, г. Санкт-Петербург, ул. Калинина, дом 2, корпус 4, литера А.