

**Silicon Schottky Diode**

- General-purpose diode for high-speed switching
- Circuit protection
- Voltage clamping
- High-level detecting and mixing
- BAS70-04S: For orientation in reel see package information below
- Pb-free (RoHS compliant) package<sup>1)</sup>
- Qualified according AEC Q101

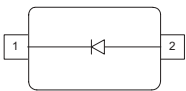

**BAS170W**  
**BAS70-02L**  
**BAS70-02W**



**BAS70**

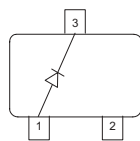

**BAS70-04**  
**BAS70-04W**

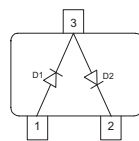

**BAS70-04S**

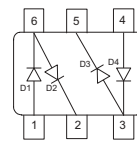

**BAS70-05**  
**BAS70-05W**

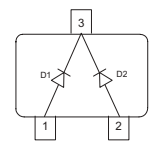

**BAS70-06**  
**BAS70-06W**

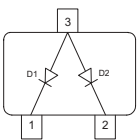

**BAS70-07**  
**BAS70-07W**

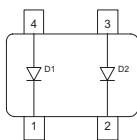

<sup>1</sup>Pb-containing package may be available upon special request

Type	Package	Configuration	$L_S$ (nH)	Marking
BAS170W	SOD323	single	1.8	white 7
BAS70	SOT23	single	1.8	73s
BAS70-02L	TSLP-2-1	single, leadless	0.4	F
BAS70-02W	SCD80	single	0.6	73
BAS70-04	SOT23	series	1.8	74s
BAS70-04S	SOT363	dual series	1.6	74s
BAS70-04W	SOT323	series	1.4	74s
BAS70-05	SOT23	common cathode	1.8	75s
BAS70-05W	SOT323	common cathode	1.4	75s
BAS70-06	SOT23	common anode	1.8	76s
BAS70-06W	SOT323	common anode	1.4	76s
BAS70-07	SOT143	parallel pair	2	77s
BAS70-07W	SOT343	parallel pair	1.8	77s

**Maximum Ratings at  $T_A = 25^\circ\text{C}$ , unless otherwise specified**

Parameter	Symbol	Value	Unit
Diode reverse voltage	$V_R$	70	V
Forward current	$I_F$	70	mA
Non-repetitive peak surge forward current $t \leq 10\text{ms}$	$I_{FSM}$	100	
Total power dissipation	$P_{tot}$		mW
BAS70, BAS70-07, $T_S \leq 72^\circ\text{C}$		250	
BAS70-02L, $T_S \leq 117^\circ\text{C}$		250	
BAS70-02W, $T_S \leq 107^\circ\text{C}$		250	
BAS70-04, BAS70-06, $T_S \leq 48^\circ\text{C}$		250	
BAS70-04S/W/-06W, BAS170W, $T_S \leq 97^\circ\text{C}$		250	
BAS70-05, $T_S \leq 22^\circ\text{C}$		250	
BAS70-05W, $T_S \leq 90^\circ\text{C}$		250	
BAS70-07W, $T_S \leq 114^\circ\text{C}$		250	
Junction temperature	$T_j$	150	$^\circ\text{C}$
Operating temperature range	$T_{op}$	-55 ... 125	
Storage temperature	$T_{stg}$	-55 ... 150	

**Thermal Resistance**

Parameter	Symbol	Value	Unit
Junction - soldering point <sup>1)</sup>	$R_{thJS}$		K/W
BAS70, BAS70-07		≤ 310	
BAS70-02L, BAS70-02W		≤ 130	
BAS70-04, BAS70-06		≤ 170	
BAS70-04S/W, BAS70-06W		≤ 410	
BAS70-05		≤ 210	
BAS70-05W		≤ 510	
BAS70-07W		≤ 240	
BAS170W		≤ 145	

**Electrical Characteristics at  $T_A = 25^\circ\text{C}$ , unless otherwise specified**

Parameter	Symbol	Values			Unit
		min.	typ.	max.	
<b>DC Characteristics</b>					
Breakdown voltage $I_{(BR)} = 10 \mu\text{A}$	$V_{(BR)}$	70	-	-	V
Reverse current $V_R = 50 \text{ V}$	$I_R$	-	-	0.1	$\mu\text{A}$
Forward voltage $I_F = 1 \text{ mA}$ $I_F = 10 \text{ mA}$ $I_F = 15 \text{ mA}$	$V_F$	300 600 720	375 705 880	410 750 1000	mV
Forward voltage matching <sup>2)</sup> $I_F = 10 \text{ mA}$	$\Delta V_F$	-	-	20	

<sup>1</sup>For calculation of  $R_{thJA}$  please refer to Application Note Thermal Resistance

<sup>2</sup> $\Delta V_F$  is the difference between lowest and highest  $V_F$  in a multiple diode component.

**Electrical Characteristics** at  $T_A = 25^\circ\text{C}$ , unless otherwise specified

Parameter	Symbol	Values			Unit
		min.	typ.	max.	
<b>AC Characteristics</b>					
Diode capacitance $V_R = 0$ , $f = 1$ MHz	$C_T$	-	1.5	2	pF
Forward resistance $I_F = 10$ mA, $f = 10$ kHz	$r_f$	-	34	-	$\Omega$
Charge carrier life time $I_F = 25$ mA	$\tau_{rr}$	-	-	100	ps

**Diode capacitance  $C_T = f(V_R)$**

$f = 1\text{MHz}$

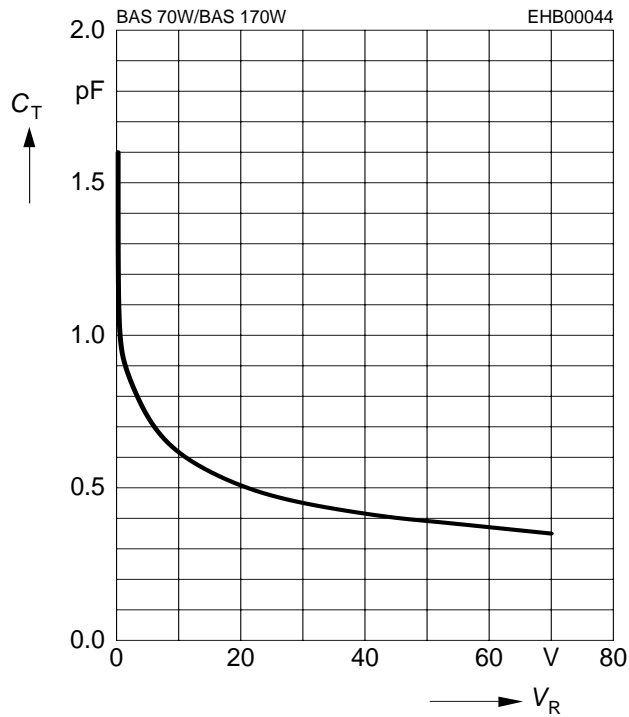

**Forward resistance  $r_f = f(I_F)$**

$f = 10\text{kHz}$



**Reverse current  $I_R = f(V_R)$**

$T_A = \text{Parameter}$

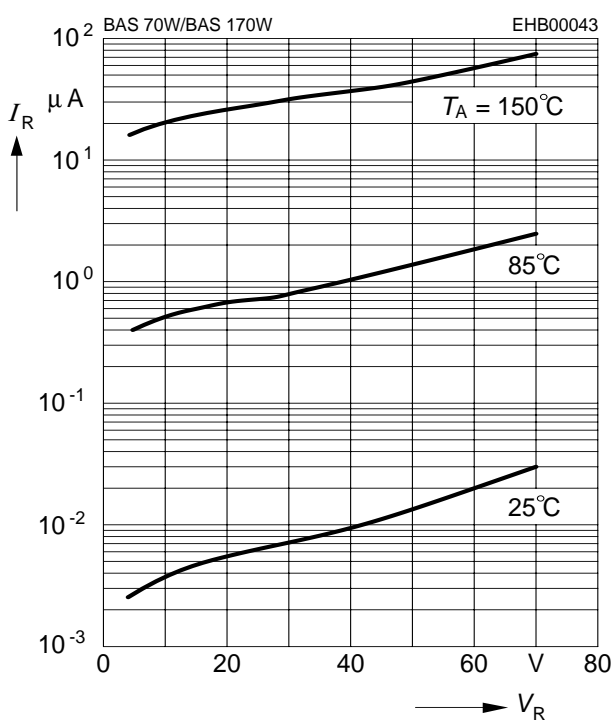

**Forward current  $I_F = f(V_F)$**

$T_A = \text{Parameter}$



**Forward current  $I_F = f(T_S)$**

BAS70, BAS70-07



**Forward current  $I_F = f(T_S)$**

BAS70-02L

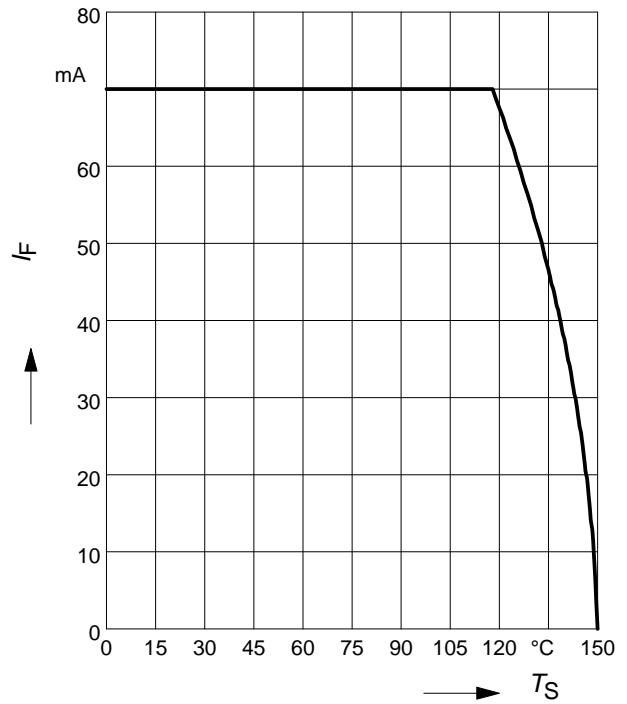

**Forward current  $I_F = f(T_S)$**

BAS70-02W



**Forward current  $I_F = f(T_S)$**

BAS70-04, BAS70-06

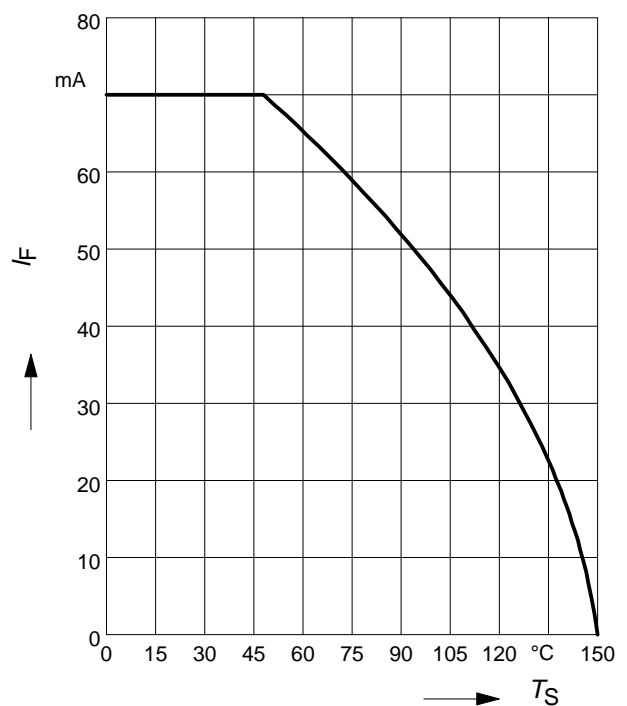

**Forward current  $I_F = f(T_S)$**   
 BAS70-04S/W, BAS70-06W, BAS170W

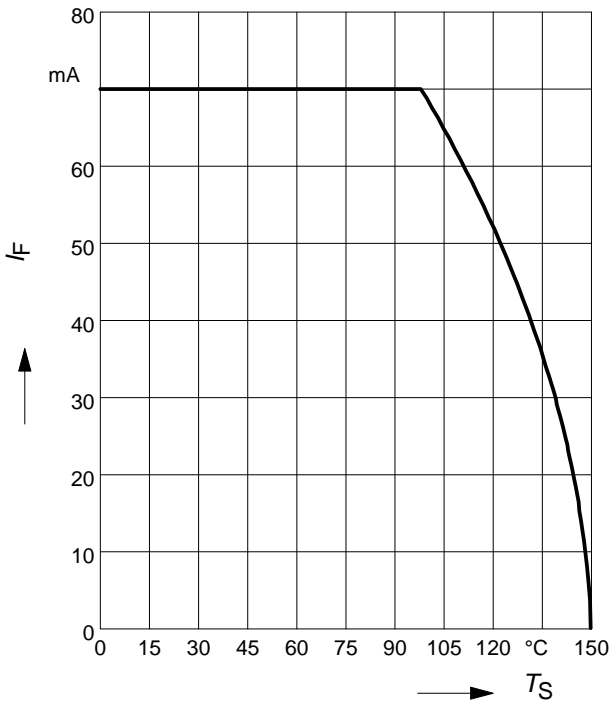

**Forward current  $I_F = f(T_S)$**   
 BAS70-05

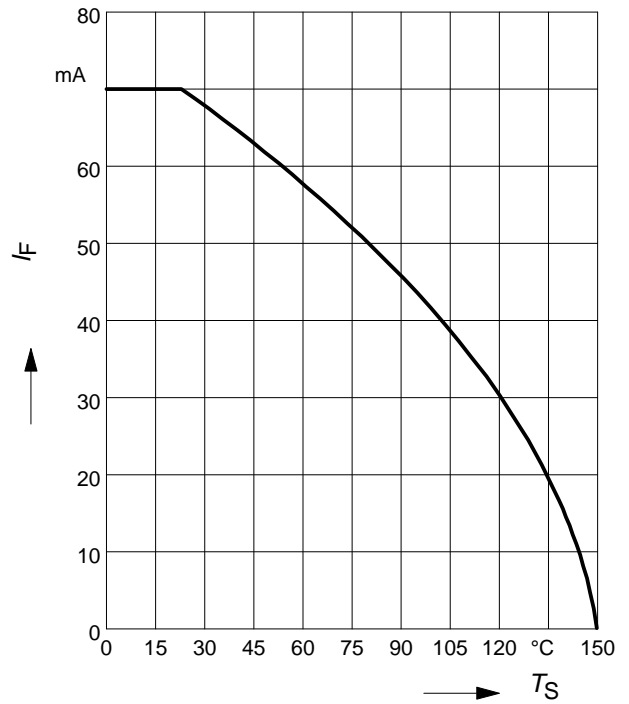

**Forward current  $I_F = f(T_S)$**   
 BAS70-05W

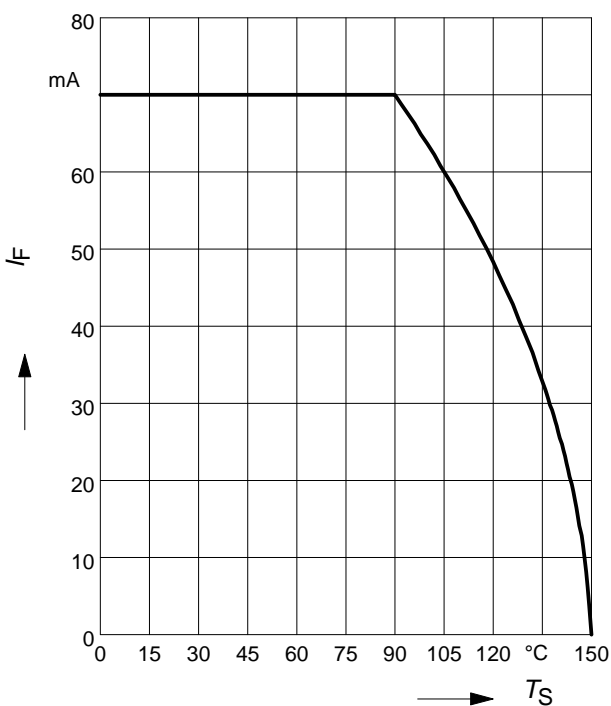

**Forward current  $I_F = f(T_S)$**   
 BAS70-07W

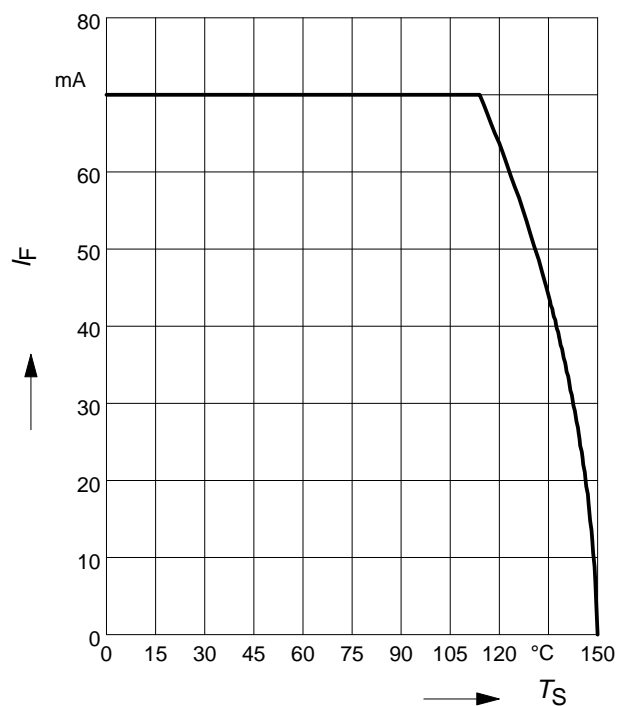

**Forward current  $I_F = f(T_S)$**

BAS170W



**Permissible Puls Load  $R_{thJS} = f(t_p)$**

BAS70



**Permissible Pulse Load**

$I_{Fmax} / I_{FDC} = f(t_p)$

BAS70

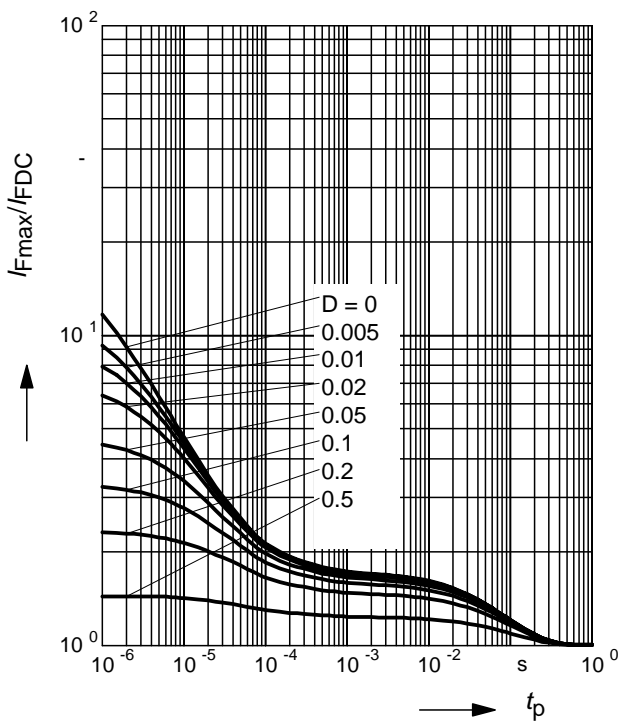

**Permissible Puls Load  $R_{thJS} = f(t_p)$**

BAS70-02L

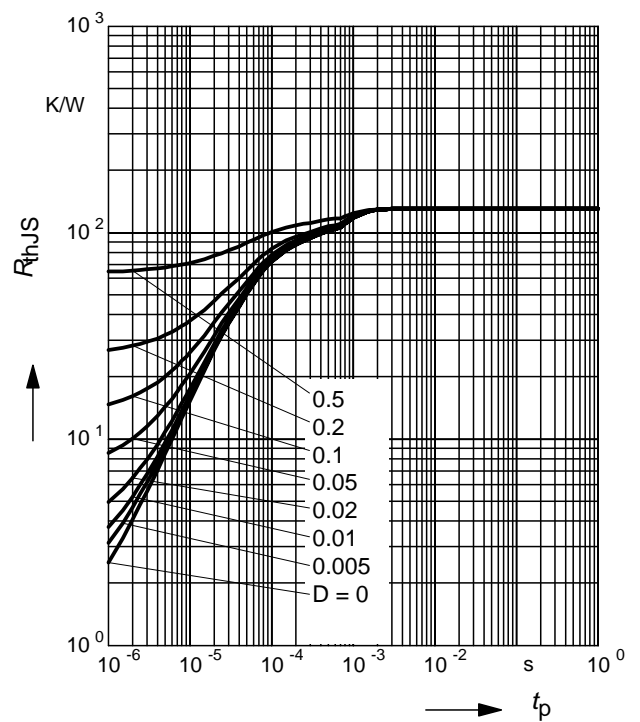



**Permissible Pulse Load**

$I_{Fmax} / I_{FDC} = f(t_p)$

BAS70-02L

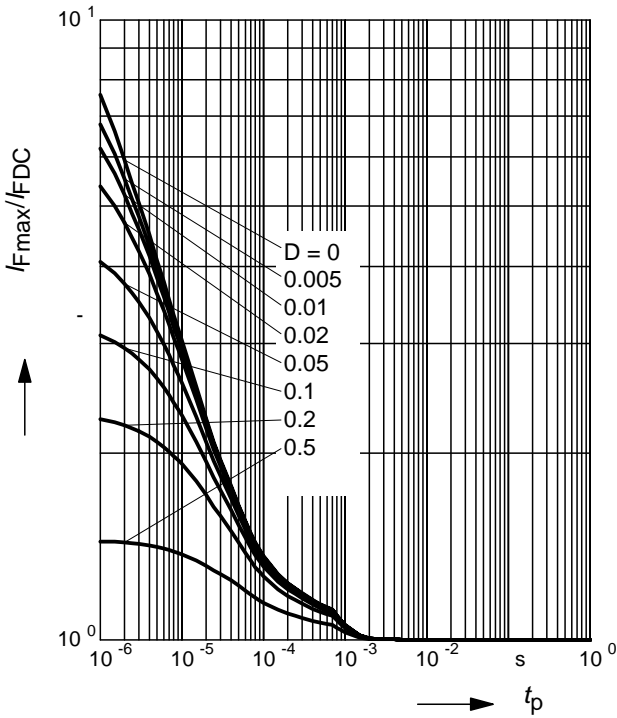

**Permissible Puls Load  $R_{thJS} = f(t_p)$**

BAS70-02W

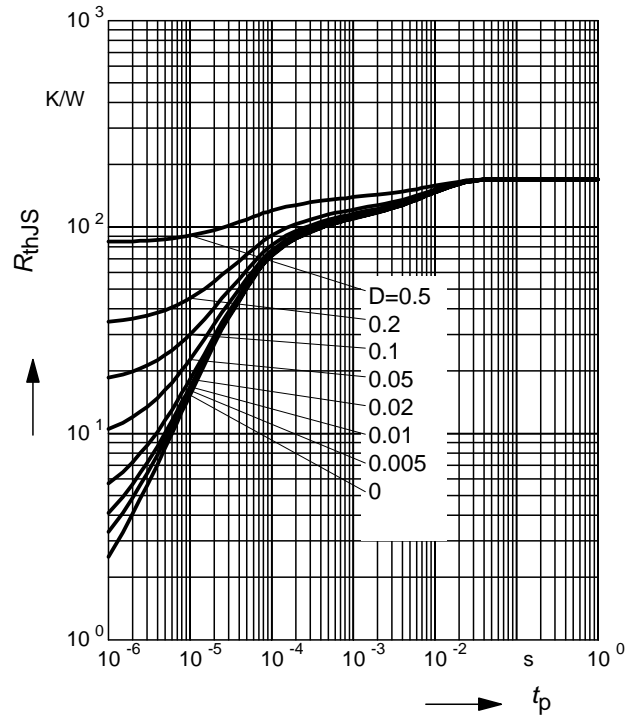

**Permissible Pulse Load**

$I_{Fmax} / I_{FDC} = f(t_p)$

BAS70-02W

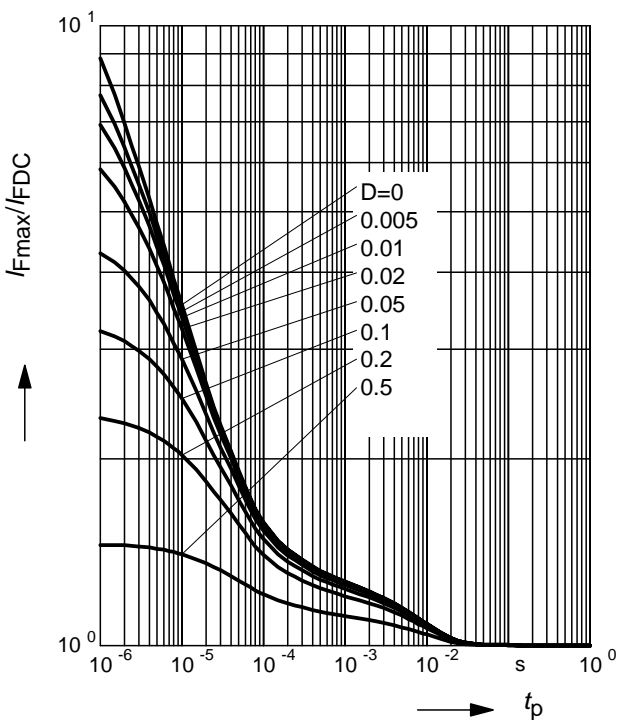

**Permissible Puls Load  $R_{thJS} = f(t_p)$**

BAS70-04, BAS70-06

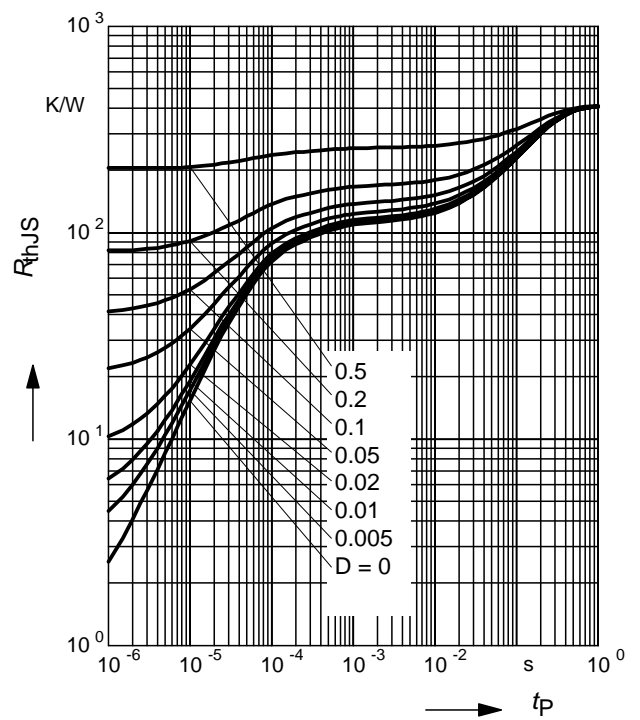

**Permissible Pulse Load**

$$I_{Fmax} / I_{FDC} = f(t_p)$$

BAS70-04, BAS70-06

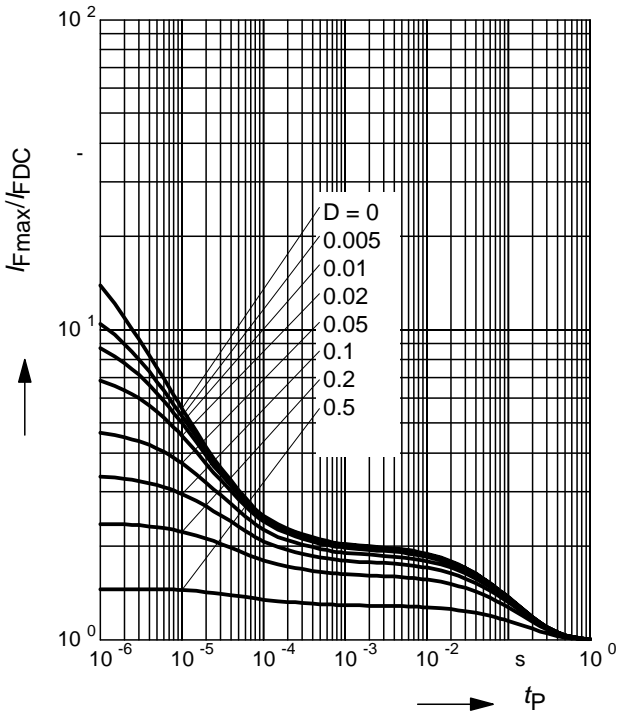

**Permissible Puls Load  $R_{thJS} = f(t_p)$**

BAS70-04S

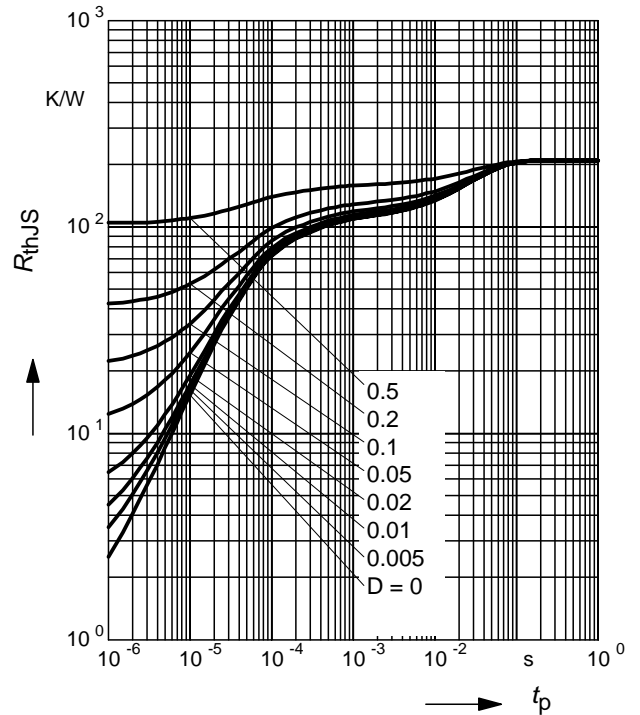

**Permissible Pulse Load**

$$I_{Fmax} / I_{FDC} = f(t_p)$$

BAS70-04S

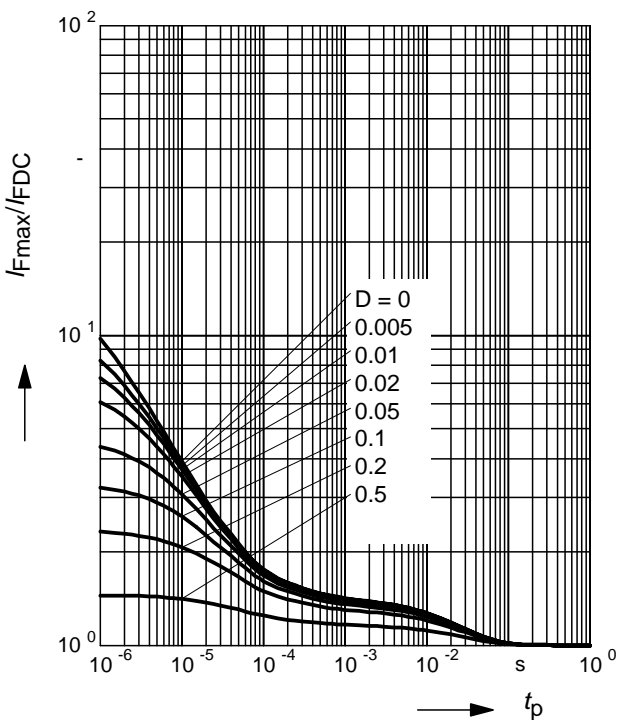

**Permissible Puls Load  $R_{thJS} = f(t_p)$**

BAS70-04W, BAS70-06W

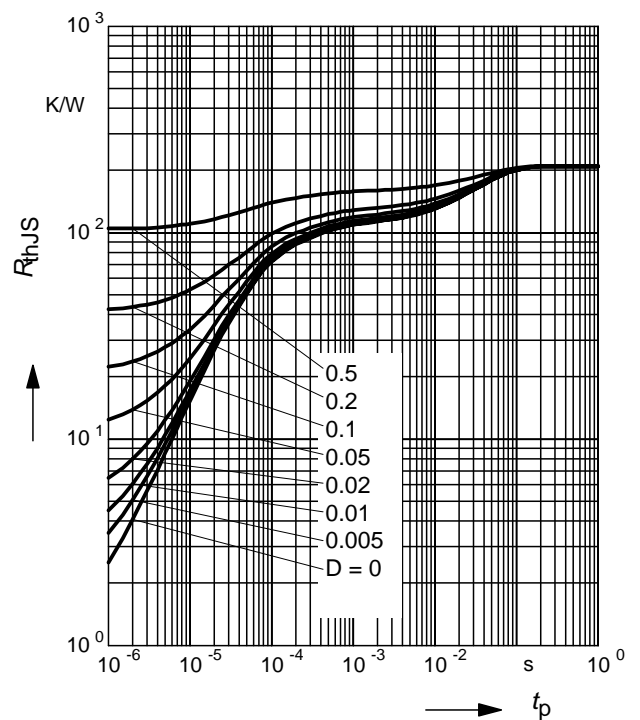

**Permissible Pulse Load**

$$I_{Fmax} / I_{FDC} = f(t_p)$$

BAS70-04W, BAS70-06W

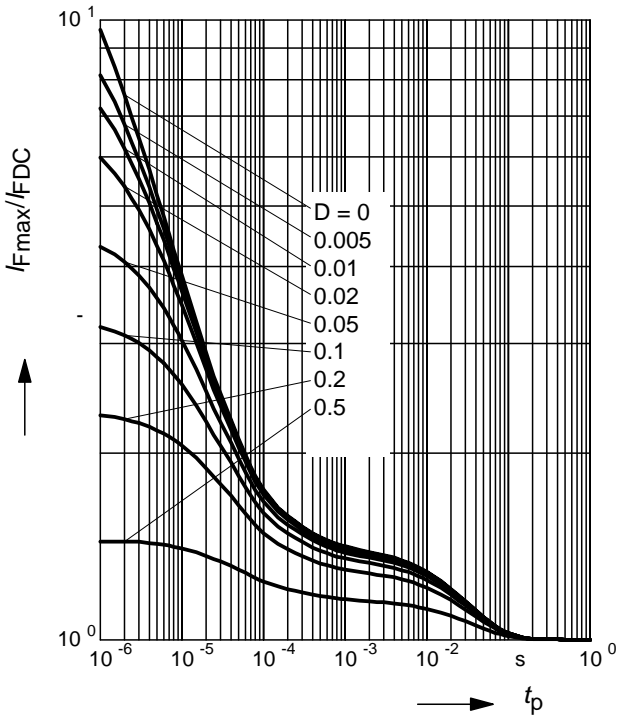

**Permissible Puls Load  $R_{thJS} = f(t_p)$**

BAS70-05

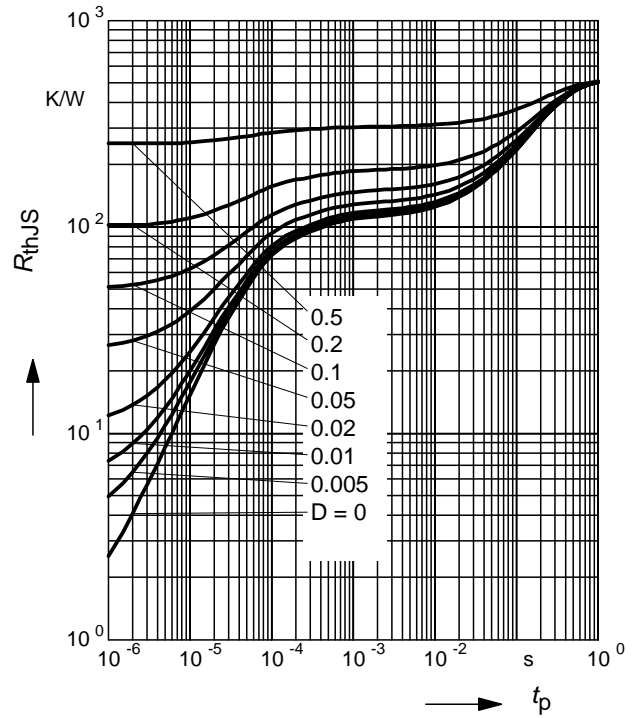

**Permissible Pulse Load**

$$I_{Fmax} / I_{FDC} = f(t_p)$$

BAS70-05

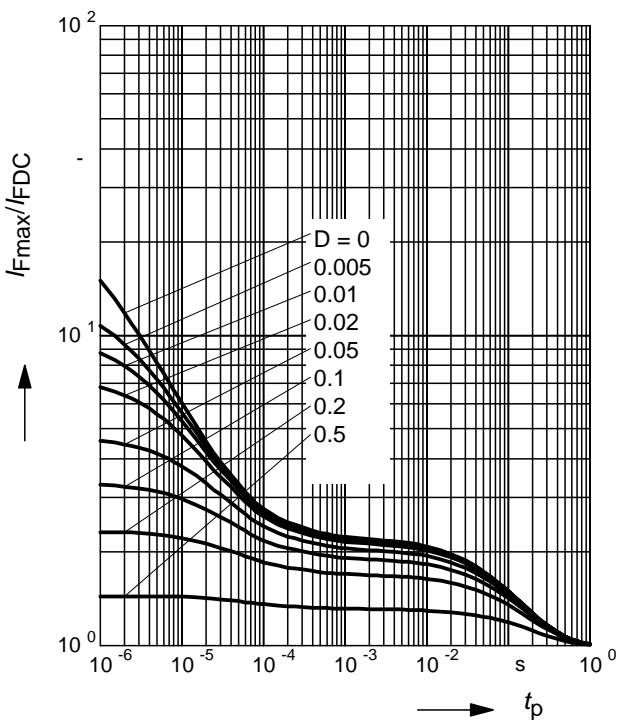

**Permissible Puls Load  $R_{thJS} = f(t_p)$**

BAS70-05W



**Permissible Pulse Load**

$I_{Fmax} / I_{FDC} = f(t_p)$

BAS70-05W

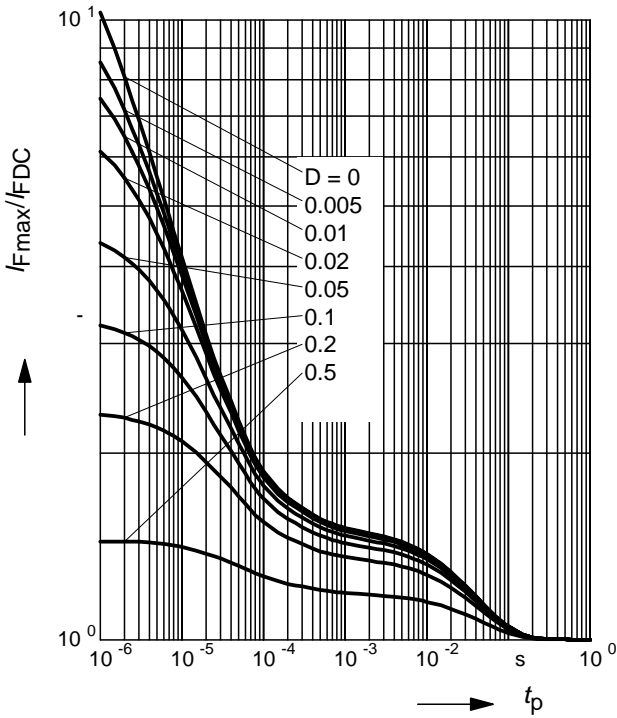

**Permissible Puls Load  $R_{thJS} = f(t_p)$**

BAS70-07W

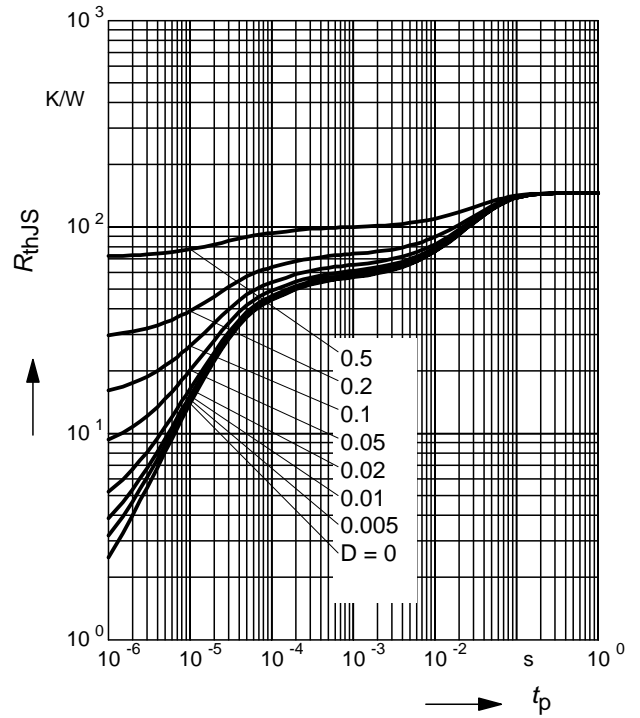

**Permissible Pulse Load**

$I_{Fmax} / I_{FDC} = f(t_p)$

BAS70-07W

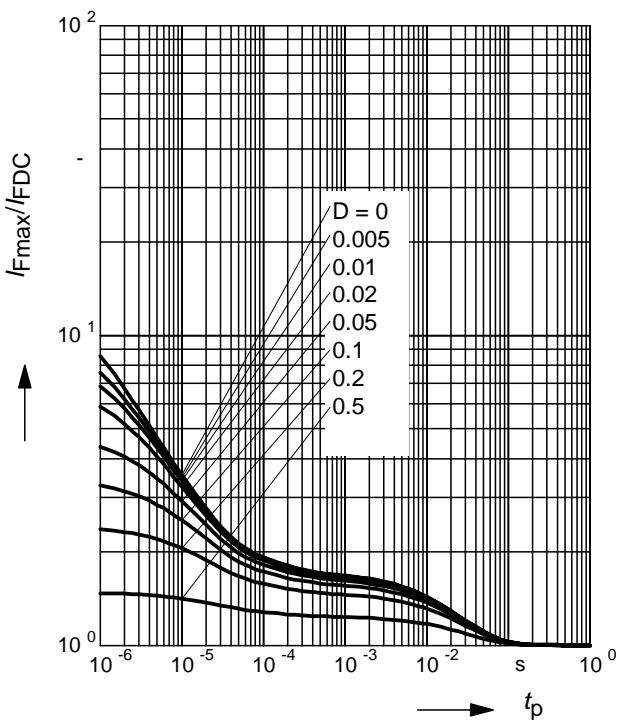

**Permissible Puls Load  $R_{thJS} = f(t_p)$**

BAS170W

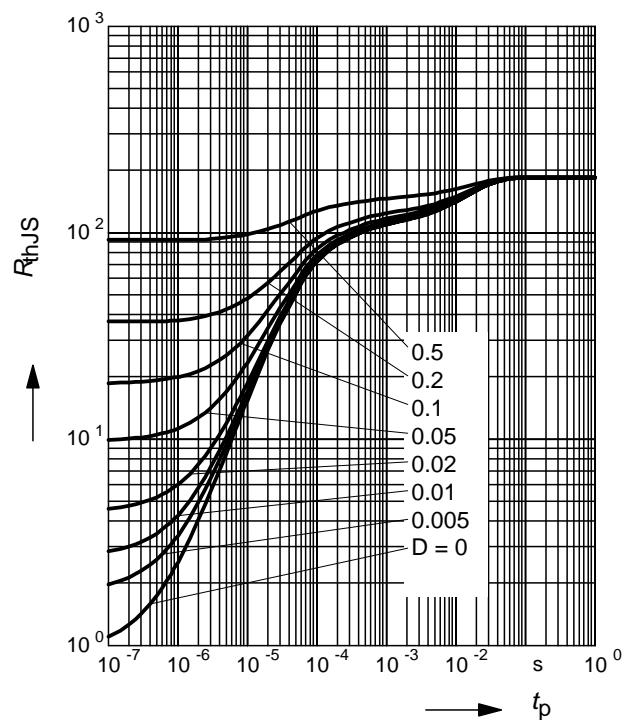

**Permissible Pulse Load**

$$I_{Fmax} / I_{FDC} = f(t_p)$$

BAS170W

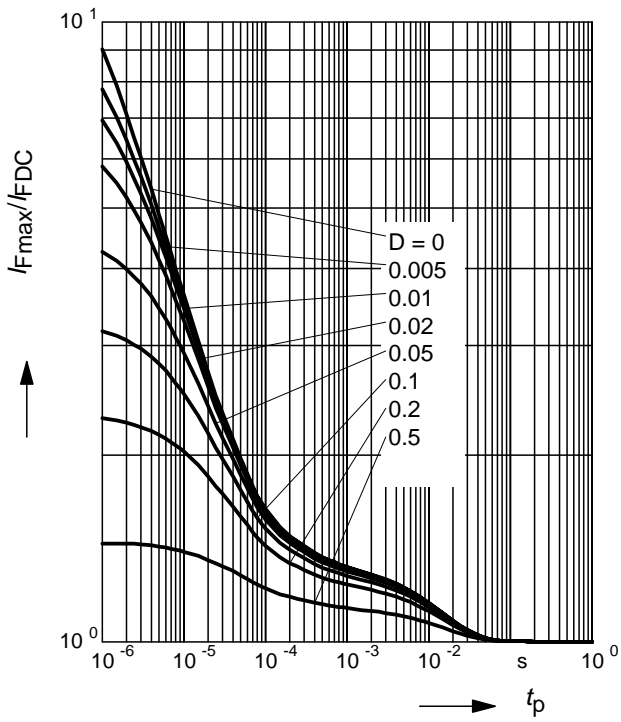

Package Outline

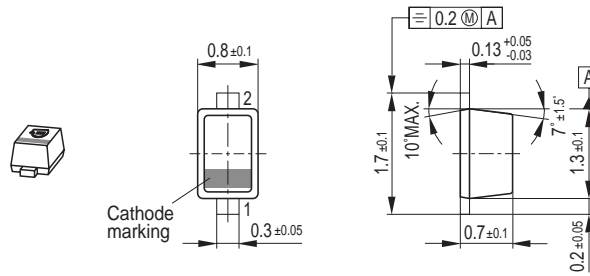

Foot Print



Marking Layout (Example)



Standard Packing

Reel  $\varnothing$ 180 mm = 3.000 Pieces/Reel  
 Reel  $\varnothing$ 180 mm = 8.000 Pieces/Reel (2 mm Pitch)  
 Reel  $\varnothing$ 330 mm = 10.000 Pieces/Reel

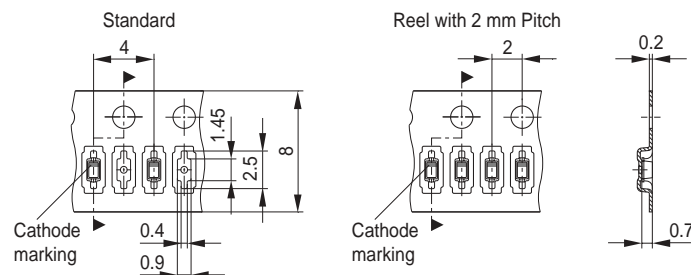

Date Code marking for discrete packages with one digit (SCD80, SC79, SC75<sup>1)</sup>) CES-Code

Month	2003	2004	2005	2006	2007	2008	2009	2010	2011	2012	2013	2014
01	a	p	A	P	a	p	A	P	a	p	A	P
02	b	q	B	Q	b	q	B	Q	b	q	B	Q
03	c	r	C	R	c	r	C	R	c	r	C	R
04	d	s	D	S	d	s	D	S	d	s	D	S
05	e	t	E	T	e	t	E	T	e	t	E	T
06	f	u	F	U	f	u	F	U	f	u	F	U
07	g	v	G	V	g	v	G	V	g	v	G	V
08	h	x	H	X	h	x	H	X	h	x	H	X
09	j	y	J	Y	j	y	J	Y	j	y	J	Y
10	k	z	K	Z	k	z	K	Z	k	z	K	Z
11	l	2	L	4	l	2	L	4	l	2	L	4
12	n	3	N	5	n	3	N	5	n	3	N	5

1) New Marking Layout for SC75, implemented at October 2005.

Package Outline

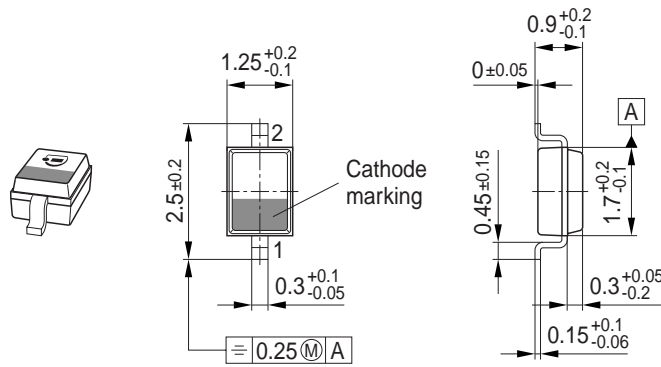

Foot Print

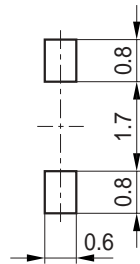

Marking Layout (Example)

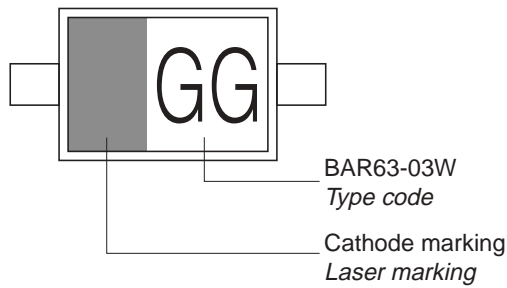

Standard Packing

Reel  $\varnothing$ 180 mm = 3.000 Pieces/Reel  
 Reel  $\varnothing$ 330 mm = 10.000 Pieces/Reel

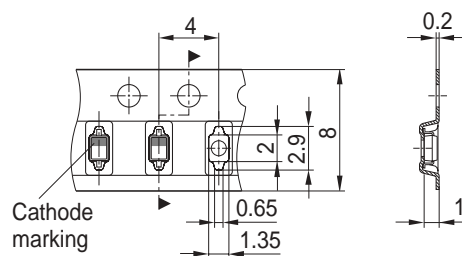



Package Outline

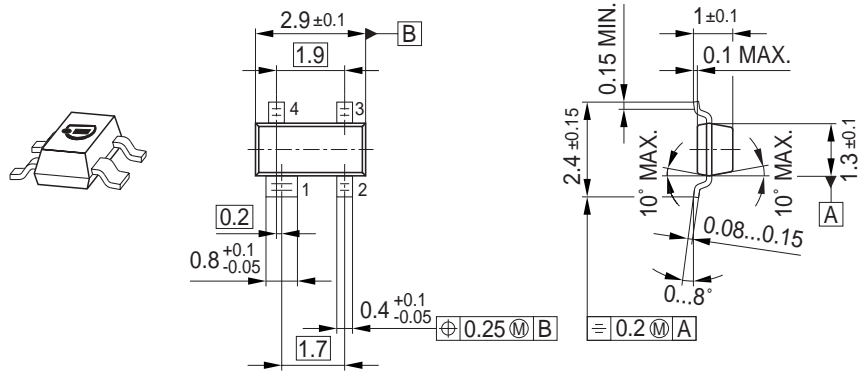

Foot Print

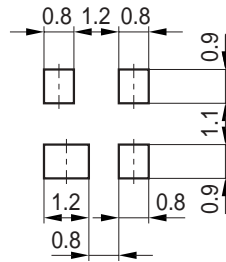

Marking Layout (Example)

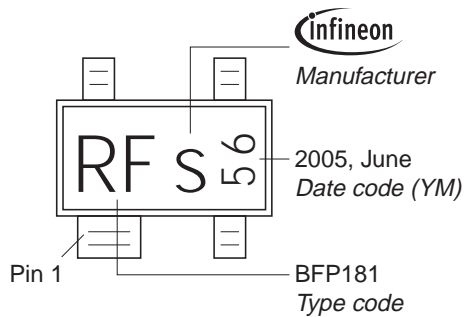

Standard Packing

Reel  $\varnothing 180$  mm = 3.000 Pieces/Reel  
 Reel  $\varnothing 330$  mm = 10.000 Pieces/Reel

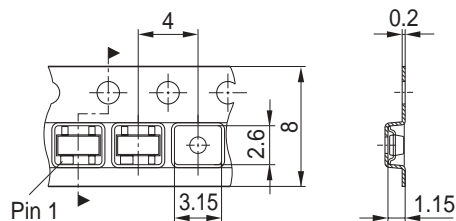

Package Outline



1) Lead width can be 0.6 max. in dambar area

Foot Print



Marking Layout (Example)

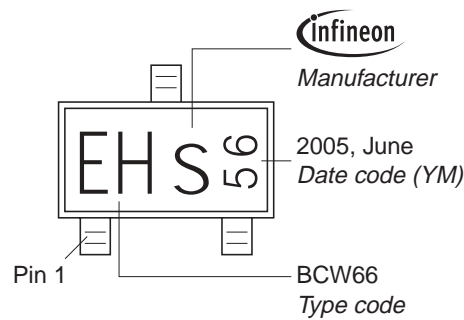

Standard Packing

Reel  $\varnothing$ 180 mm = 3.000 Pieces/Reel  
 Reel  $\varnothing$ 330 mm = 10.000 Pieces/Reel

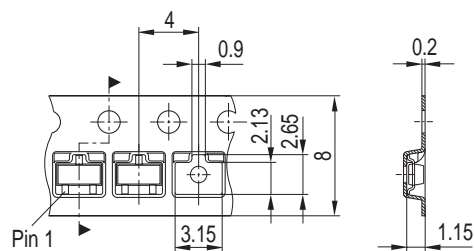

Package Outline



Foot Print



Marking Layout (Example)

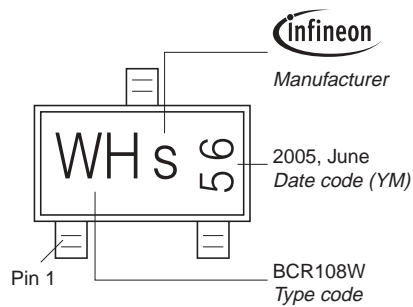

Standard Packing

Reel  $\varnothing$ 180 mm = 3.000 Pieces/Reel  
 Reel  $\varnothing$ 330 mm = 10.000 Pieces/Reel

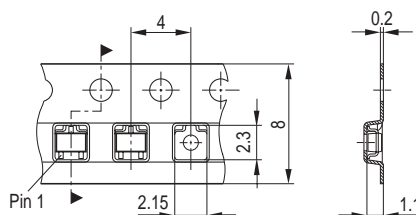

Package Outline

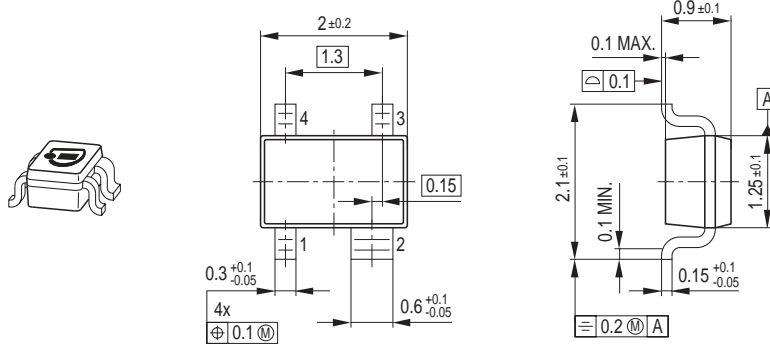

Foot Print

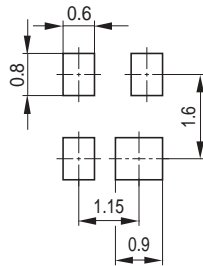

Marking Layout (Example)

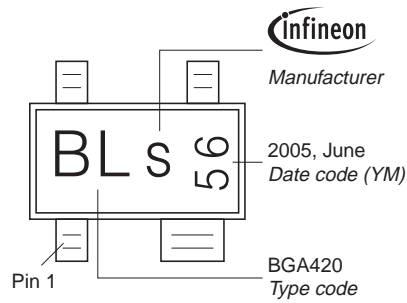

Standard Packing

Reel ø180 mm = 3.000 Pieces/Reel  
 Reel ø330 mm = 10.000 Pieces/Reel

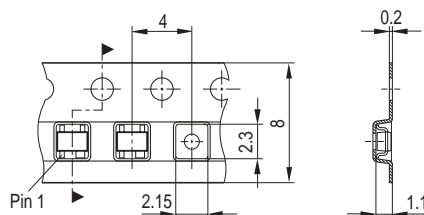

Package Outline

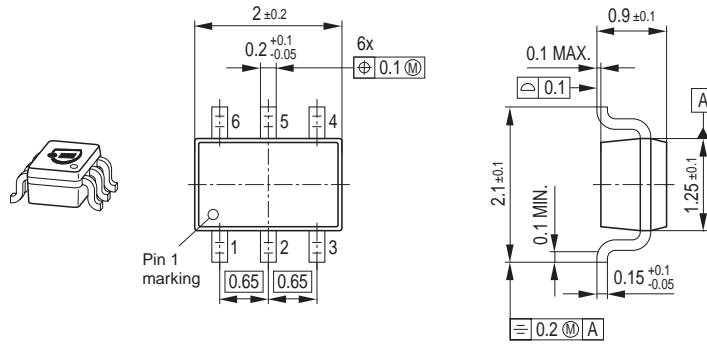

Foot Print

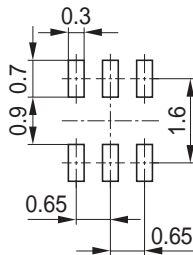

Marking Layout (Example)

Small variations in positioning of Date code, Type code and Manufacture are possible.

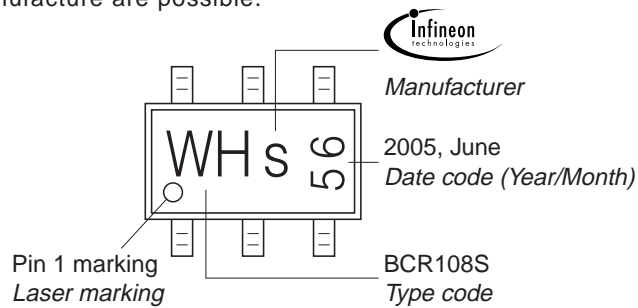

Standard Packing

Reel  $\varnothing$ 180 mm = 3.000 Pieces/Reel  
 Reel  $\varnothing$ 330 mm = 10.000 Pieces/Reel

For symmetric types no defined Pin 1 orientation in reel.

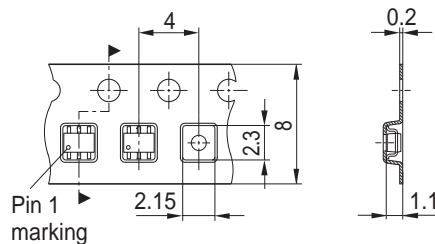

### Package Outline



1) Dimension applies to plated terminal

### Foot Print

For board assembly information please refer to Infineon website "Packages"



■ Copper    □ Solder mask    ▨ Stencil apertures

### Marking Layout (Example)

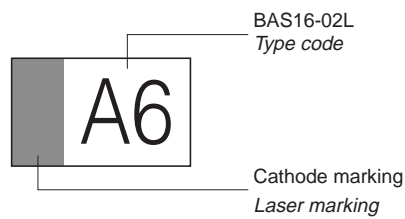

### Standard Packing

Reel ø180 mm = 15.000 Pieces/Reel  
 Reel ø330 mm = 50.000 Pieces/Reel (optional)

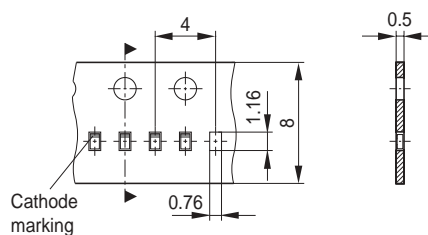

Edition 2006-02-01

Published by

Infineon Technologies AG

81726 München, Germany

© Infineon Technologies AG 2007.

All Rights Reserved.

### **Attention please!**

The information given in this dokument shall in no event be regarded as a guarantee of conditions or characteristics ("Beschaffenhheitsgarantie"). With respect to any examples or hints given herein, any typical values stated herein and/or any information regarding the application of the device, Infineon Technologies hereby disclaims any and all warranties and liabilities of any kind, including without limitation warranties of non-infringement of intellectual property rights of any third party.

### **Information**

For further information on technology, delivery terms and conditions and prices please contact your nearest Infineon Technologies Office ([www.infineon.com](http://www.infineon.com)).

### **Warnings**

Due to technical requirements components may contain dangerous substances. For information on the types in question please contact your nearest Infineon Technologies Office.

Infineon Technologies Components may only be used in life-support devices or systems with the express written approval of Infineon Technologies, if a failure of such components can reasonably be expected to cause the failure of that life-support device or system, or to affect the safety or effectiveness of that device or system.

Life support devices or systems are intended to be implanted in the human body, or to support and/or maintain and sustain and/or protect human life. If they fail, it is reasonable to assume that the health of the user or other persons may be endangered.



Компания «ЭлектроПласт» предлагает заключение долгосрочных отношений при поставках импортных электронных компонентов на взаимовыгодных условиях!

Наши преимущества:

- Оперативные поставки широкого спектра электронных компонентов отечественного и импортного производства напрямую от производителей и с крупнейших мировых складов;
- Поставка более 17-ти миллионов наименований электронных компонентов;
- Поставка сложных, дефицитных, либо снятых с производства позиций;
- Оперативные сроки поставки под заказ (от 5 рабочих дней);
- Экспресс доставка в любую точку России;
- Техническая поддержка проекта, помощь в подборе аналогов, поставка прототипов;
- Система менеджмента качества сертифицирована по Международному стандарту ISO 9001;
- Лицензия ФСБ на осуществление работ с использованием сведений, составляющих государственную тайну;
- Поставка специализированных компонентов (Xilinx, Altera, Analog Devices, Intersil, Interpoint, Microsemi, Aeroflex, Peregrine, Syfer, Eurofarad, Texas Instrument, Miteq, Cobham, E2V, MA-COM, Hittite, Mini-Circuits, General Dynamics и др.);

Помимо этого, одним из направлений компании «ЭлектроПласт» является направление «Источники питания». Мы предлагаем Вам помощь Конструкторского отдела:

- Подбор оптимального решения, техническое обоснование при выборе компонента;
- Подбор аналогов;
- Консультации по применению компонента;
- Поставка образцов и прототипов;
- Техническая поддержка проекта;
- Защита от снятия компонента с производства.



#### Как с нами связаться

**Телефон:** 8 (812) 309 58 32 (многоканальный)

**Факс:** 8 (812) 320-02-42

**Электронная почта:** [org@eplast1.ru](mailto:org@eplast1.ru)

**Адрес:** 198099, г. Санкт-Петербург, ул. Калинина, дом 2, корпус 4, литера А.