

110 W / 54 V Power Supply Demo Board using ICL5101 in PFC & LLC Topology

Application Note

About this document

Scope and purpose

This document presents the details about the ICL5101 evaluation board and ICL5101 product feature set. It illustrates all necessary steps to get the board and related environment up and running, and provides all information to become familiar with this comprehensive solution. The evaluation board passes EMI conductive, radiated and is CE certificated.

The ICL5101 is a mixed signal PFC + resonant controller for non-dimmable and dimmable LED light applications using LLC topology for highest efficiency levels exceeding 94 %, including a PFC stage for lowest THD < 5 % and high power factor correction figures > 95 % @ > 50 % load in a wide line input voltage range. The ICL5101 evaluation board is designed to evaluate the performance and flexibility of the ICL5101. It supports an output power of 110 W, easily configurable by using only resistor settings without any user interface tool.

Intended audience

This document is intended for anyone who needs to use the ICL5101 evaluation board, either for their own application tests or to use it as a reference for a new ICL5101-based development.



Table of Contents

Table of Contents

1 Introduction 3

2 Technical Specification 4

3 Schematic 5

4 Key Measurements and Waveforms 6

4.1 Line Regulation, Startup Time, Load Regulation, PF and THD 6

4.1.1 Line Regulation 6

4.1.2 Startup Time 7

4.1.3 Load Regulation 9

4.1.4 PF and THD vs. P_{OUT} 9

4.2 Surge Protection 12

4.3 Harmonics 13

4.4 System Efficiency and Standby Power 14

4.4.1 System Efficiency 14

4.4.2 Power Consumption at Output Open Loop (Standby Power) 15

4.5 EMI Test 16

5 Surge, Flicker & Burst Test Results 20

5.1 Surge 20

5.2 Flicker 21

5.3 Burst 23

6 Power Transformer Specification 24

6.1 Common Mode Choke Spec L1 24

6.2 PFC Choke Spec T1 25

6.3 LLC Resonant Choke Spec L2 26

6.4 LLC Transformer Spec T2 27

7 Board Layout 28

8 Bill of Material (BOM) 29

9 References 33

Introduction

1 Introduction

This application note describes the characteristics and features of a 110 W SMPS demonstration board with constant 54 V voltage output. High efficiency, high PF, low THD and very stable output voltage with low ripple at whole power range are the key features of this demonstration board, which makes it very suitable to be used as a primary power supply for low power systems, such as LED lighting. Its compact design and low BOM cost is due to Infineon IC ICL5101 (CrCM PFC and resonant block are integrated together), which is used as main controller here. With this highly integrated smart IC, the circuit design is dramatically simplified, which results space and BOM cost saving. Furthermore, numerous monitor and protection features ensure highest reliability.

Key specification measurements and waveforms are also shown in this application note.

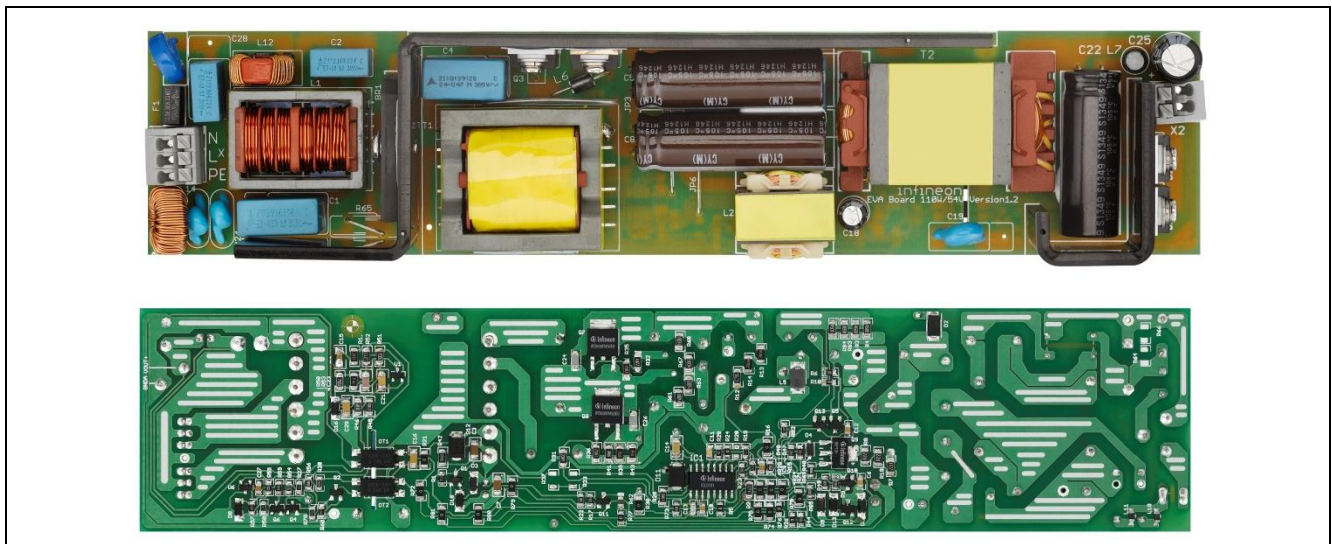

Figure 1 Demonstration Board of 110 W / 54 V LED Driver

Technical Specification

2 Technical Specification

This demo board consists of a CrCM PFC and a half-bridge LLC, which outputs a stable 54 V_{dc} voltage.

The PFC stage of this demo board is controlled by the PFC block of the ICL5101, which has an integrated digital PFC control loop and improved compensation for low THD of AC input current. It operates in critical conduction mode (CrCM) in a load range from 10 % to 100 % to achieve a very good power factor and very low THD. When the load is smaller than 10 %, in order to limit the PFC switching frequency, the IC controls the PFC to operate in discontinuous conduction mode (DCM).

The half-bridge LLC stage has a fixed duty cycle of $D=0.5$ and an adjustable self-adapting dead time from 0.5 μ s to 1 μ s. The operation frequency starts from typical 135 kHz at start-up and decreases to a range of between 45 kHz (full load) and 75 kHz (output open loop). The 54 V output voltage has a very stable value throughout the whole output power range. The value variation is tested to be smaller than 0.2 % from full load to open loop. Over voltage protection (OVP) is implemented at the main output. When the output voltage reaches 60 V, the main converter is stopped by the OVP circuit. It starts to operate again when the main output decreases to 54 V. In addition, many other protection functions are also implemented, such as Output Short Circuit Protection of the main output (OSCP), LLC primary winding short circuit protection (WSCP), Capacitive Mode Protection of the main output (CMP), LLC Over Current Protection (LOCP), over temperature protection (OTP) at certain hot spot on board and more. These protection functions are realized by the built-in protection functions of the IC ICL5101.

Features

- Input voltage range: 85–305 V_{AC}
- Input voltage frequency: 47–63 Hz
- Regulated main output voltage: 54 V_{DC} / 2.06 A
- Efficiency at nominal load: ≥ 93.5 % at 230 V_{AC}
- Input current THD: < 10 % @ > 35 % Load at 230 V_{AC}
- Harmonics: According to EN61000-3-2 Class-D
- EMI: According to EN55015
- Safety : According to EN61347-2-13
- Board dimensions: 247.3 mm (L) x 48.25 mm (W) x 34.2 mm (H)

Schematic

3 Schematic

Figure 2 shows the schematic of the ICL5101 demonstration board.

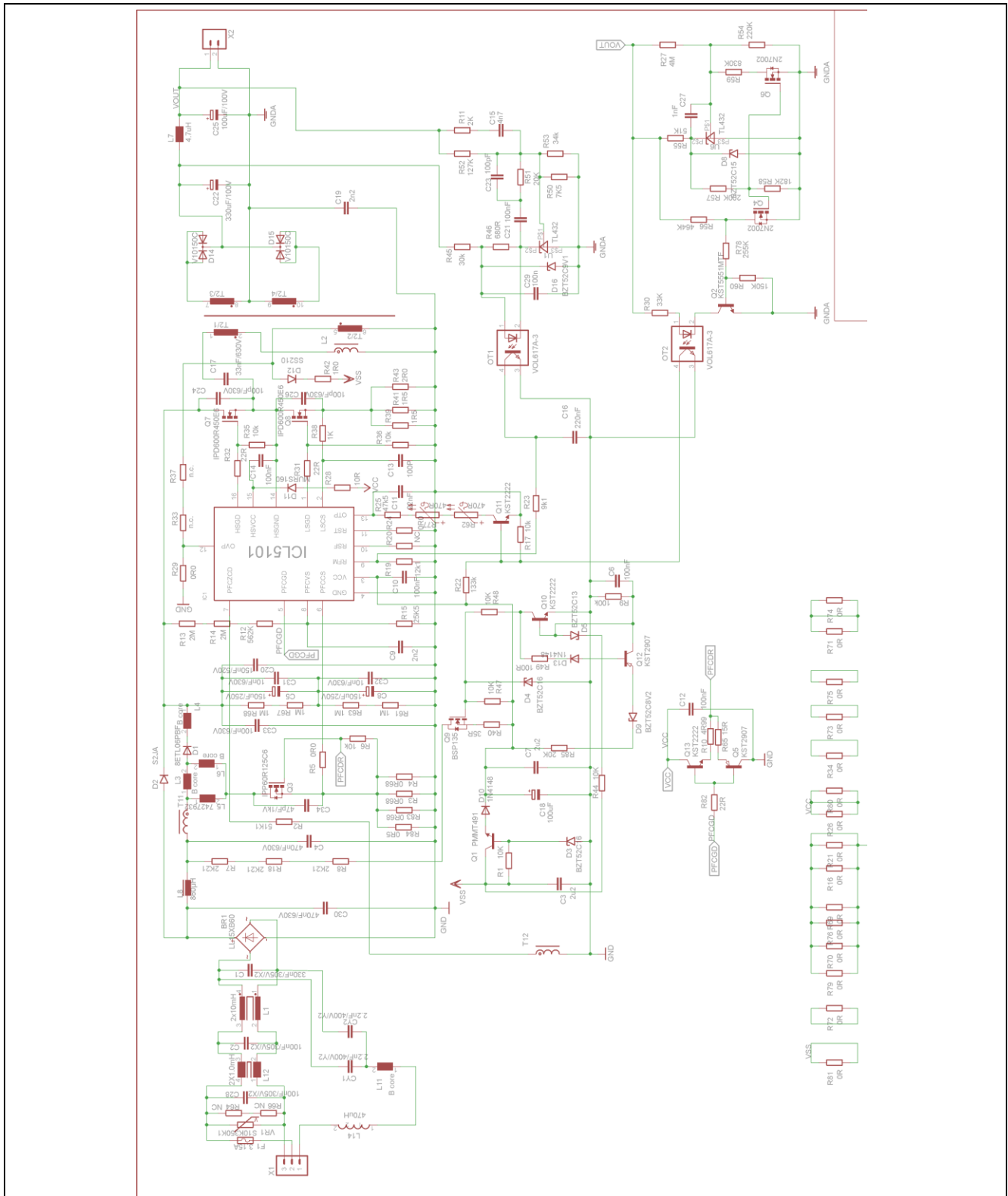

Figure 2 Schematic of 110 W / 54 V Power Supply Demo Board

Key Measurements and Waveforms

4 Key Measurements and Waveforms

4.1 Line Regulation, Startup Time, Load Regulation, PF and THD

4.1.1 Line Regulation

The output voltage of the demo board is tested under nominal load (110 W) with input voltages from 85 V_{AC} up to 300 V_{AC}.

The detailed test results are shown in [Figure 3](#).

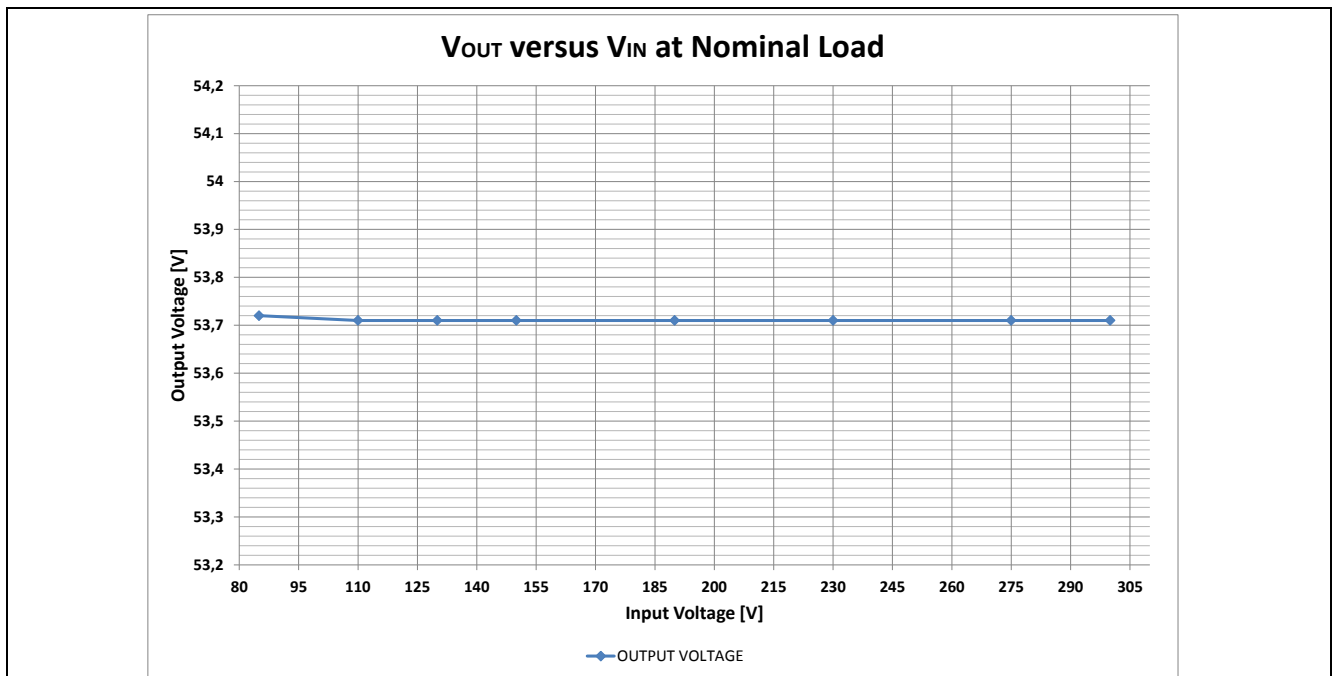

Figure 3 DC Output Voltage at Different V_{IN} Values

Key Measurements and Waveforms

4.1.2 Startup Time

Start-up time is shorter than 200ms at whole input voltage and power range. Oscilloscope pictures are shown in pictures from **Figure 4** to **Figure 9**

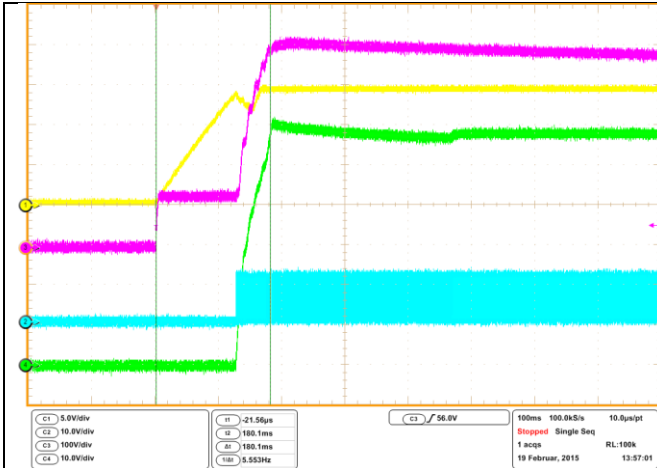

Figure 4: AC Input Voltage 85V_{ACIN}, NO Load
 CH1: Chip Supply Voltage V_{CC} (Yellow) to IC GND; 5V/div
 CH2: Low Side Gate Drive V_{LSGD} (Blue) to IC GND; 10V/div
 CH3: PFC BUS Voltage V_{BUS} to Power GND (Magenta); 100V/div
 CH4: Output Voltage V_{OUT} (Green) to Sec GND; 10V/div
 Time: 100ms/div;
 Start-up time: 180.1ms

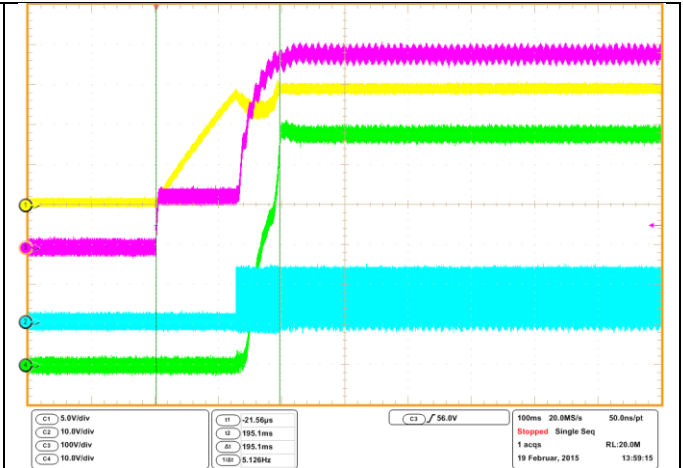

Figure 5: AC Input Voltage 85V_{ACIN}, Full Load
 CH1: Chip Supply Voltage V_{CC} (Yellow) to IC GND; 5V/div
 CH2: Low Side Gate Drive V_{LSGD} (Blue) to IC GND; 10V/div
 CH3: PFC BUS Voltage V_{BUS} to Power GND (Magenta); 100V/div
 CH4: Output Voltage V_{OUT} (Green) to Sec GND; 10V/div
 Time: 100ms/div;
 Start-up time: 195.1ms

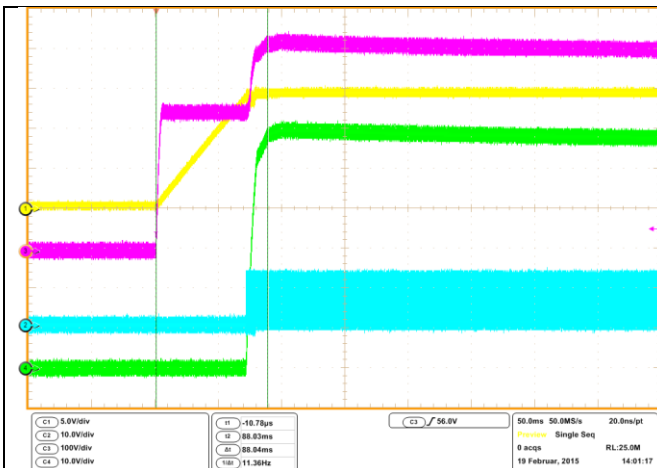

Figure 6: AC Input Voltage 230V_{ACIN}, NO Load
 CH1: Chip Supply Voltage V_{CC} (Yellow) to IC GND; 5V/div
 CH2: Low Side Gate Drive V_{LSGD} (Blue) to IC GND; 10V/div
 CH3: PFC BUS Voltage V_{BUS} to Power GND (Magenta); 100V/div
 CH4: Output Voltage V_{OUT} (Green) to Sec GND; 10V/div
 Time: 50ms/div;
 Start-up time: 88ms

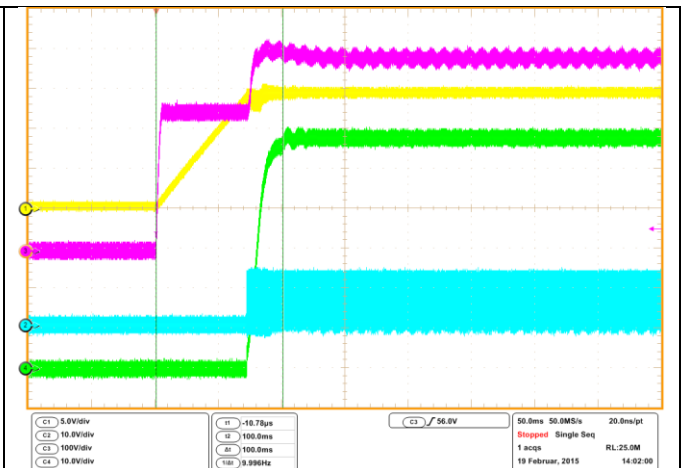

Figure 7: AC Input Voltage 230V_{ACIN}, Full Load
 CH1: Chip Supply Voltage V_{CC} (Yellow) to IC GND; 5V/div
 CH2: Low Side Gate Drive V_{LSGD} (Blue) to IC GND; 10V/div
 CH3: PFC BUS Voltage V_{BUS} to Power GND (Magenta); 100V/div
 CH4: Output Voltage V_{OUT} (Green) to Sec GND; 10V/div
 Time: 50ms/div;
 Start-up time: 100ms

Key Measurements and Waveforms

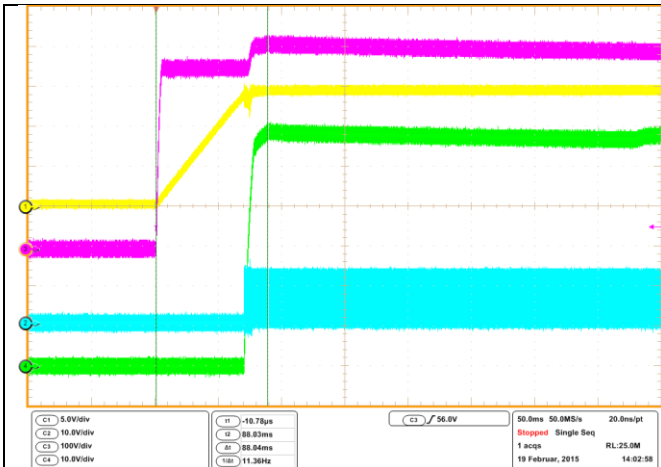

Figure 8: AC Input Voltage $300V_{ACIN}$, NO Load

CH1: Chip Supply Voltage V_{CC} (Yellow) to IC GND; 5V/div
 CH2: Low Side Gate Drive V_{LSGD} (Blue) to IC GND; 10V/div
 CH3: PFC BUS Voltage V_{BUS} to Power GND (Magenta); 100V/div
 CH4: Output Voltage V_{OUT} (Green) to Sec GND; 10V/div
 Time: 50ms/div;
 Start-up time: 88ms

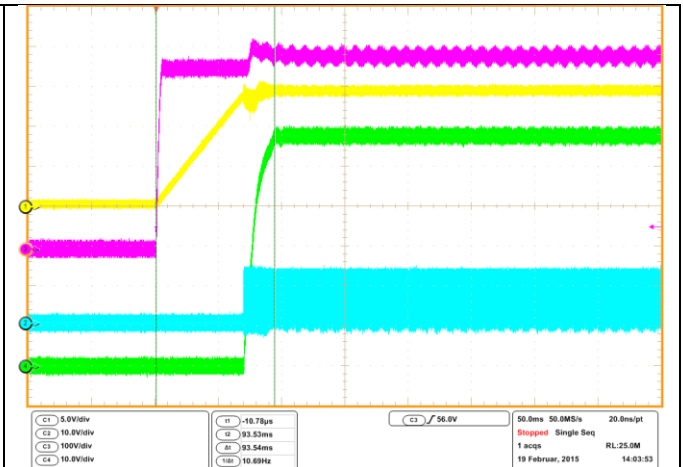

Figure 9: AC Input Voltage $300V_{ACIN}$, Full Load

CH1: Chip Supply Voltage V_{CC} (Yellow) to IC GND; 5V/div
 CH2: Low Side Gate Drive V_{LSGD} (Blue) to IC GND; 10V/div
 CH3: PFC BUS Voltage V_{BUS} to Power GND (Magenta); 100V/div
 CH4: Output Voltage V_{OUT} (Green) to Sec GND; 10V/div
 Time: 50ms/div;
 Start-up time: 93.5ms

Key Measurements and Waveforms

4.1.3 Load Regulation

The output voltage of the demo board is tested at 230 Vac input voltage and with loads from 0 % up to 100 % (110 W). The detailed test results are shown in Figure 10.

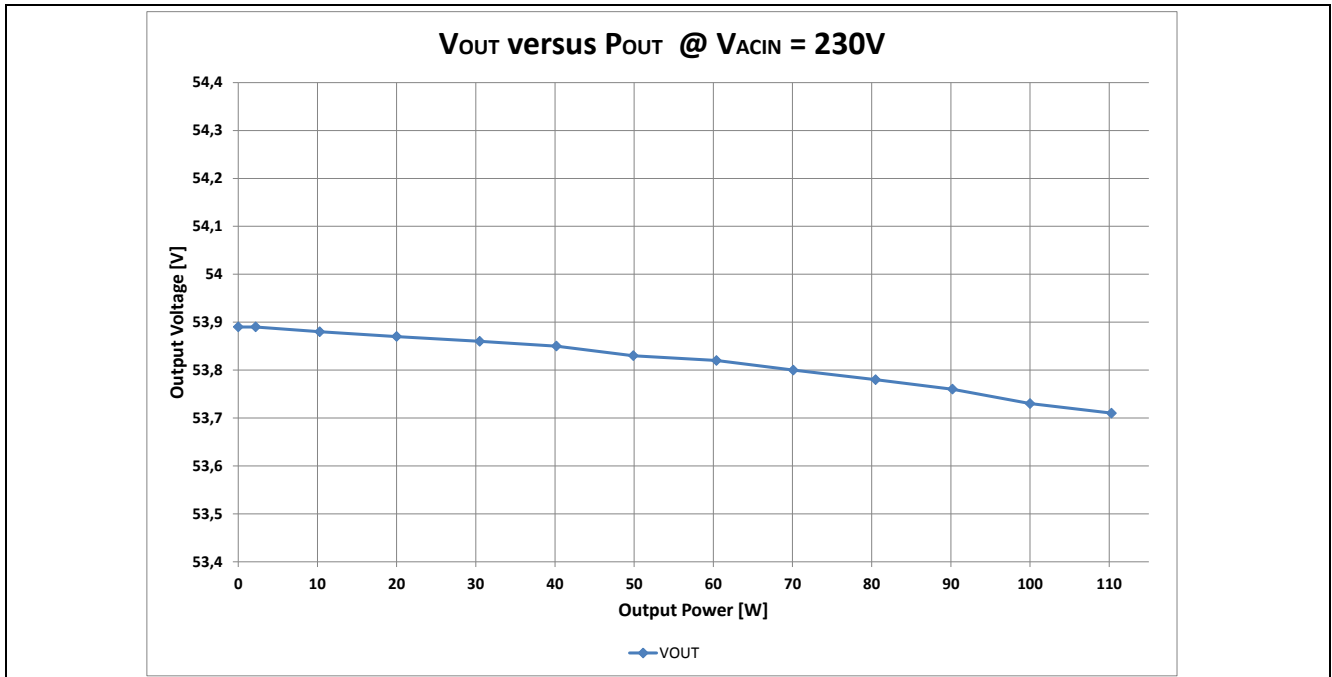

Figure 10 Output Voltage V_{OUT} versus P_{OUT}

4.1.4 PF and THD vs. P_{OUT}

Due to the smart internal digital PFC controller and improved THD correction of the ICL5101, PF values of greater than 94 % and THD values of lower than 10 % from loads upwards of 45 % are achieved at V_{IN} = 230 Vac. The detailed test results are shown in Figure 11.

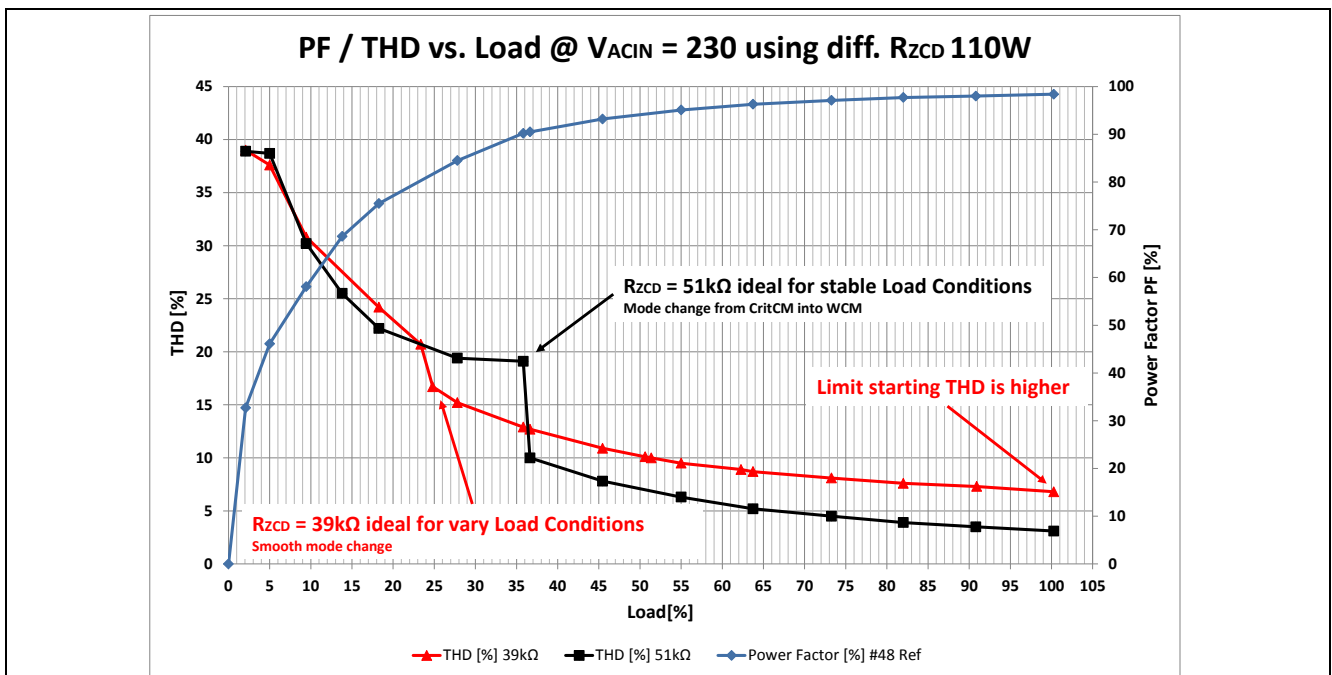

Figure 11 PF and THD versus Load

Key Measurements and Waveforms

Introduction THD Adjustment:

In order to provide an excellent THD result, the THD of the ICL5101 is adjustable. Especially at high line input voltage and low load condition, the THD is a critical value. It doesn't matter in which condition:

- Line input voltage
- Stable load
- Load variation

the ICL5101 is providing best results for all cases – only in trimming the ZCD resistor at PIN 7 see Figure 12.

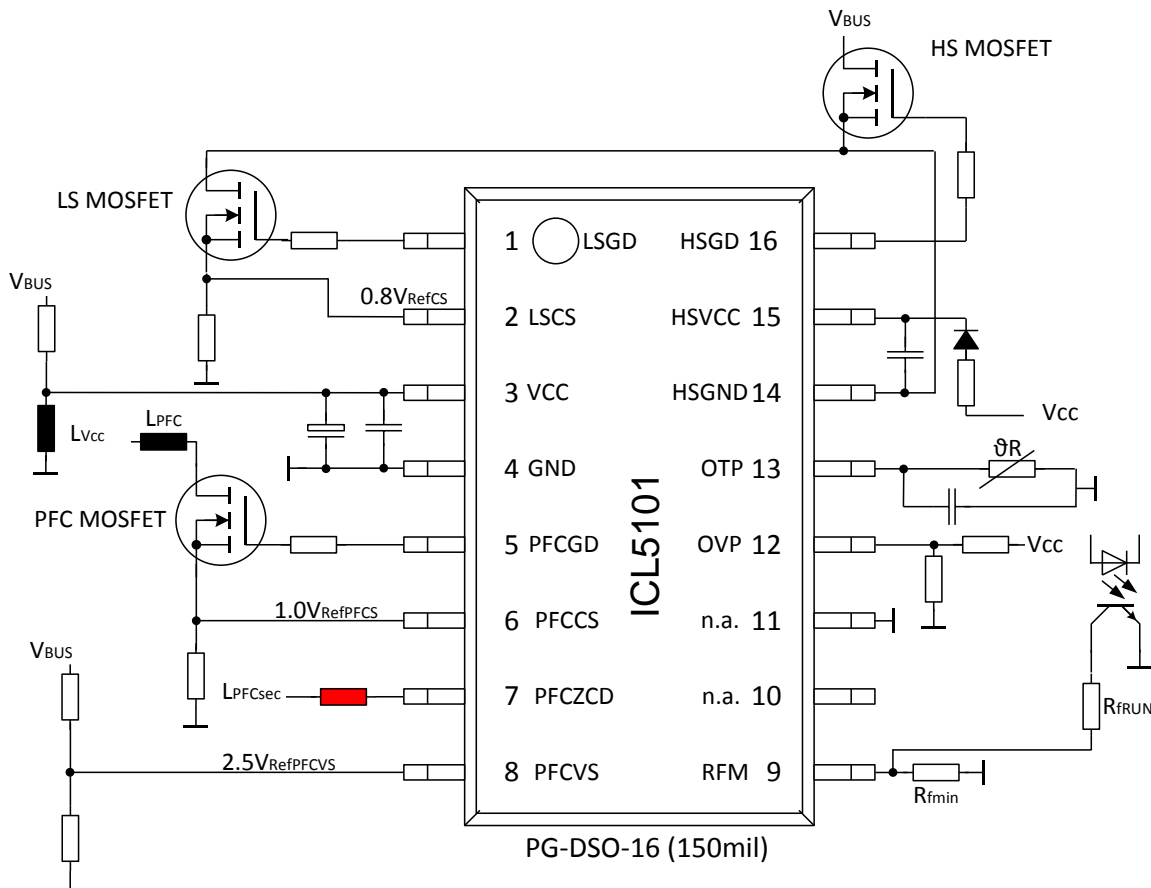

Figure 12 PIN SetUP ICL5101

How to do:

To improve the THD the resistor – see red signed resistor in Figure 12 – at ZCD PIN 7 can be trimmed to an optimal value (several k-ohm ~ 20 up to 100k) in order to reach best THD results.

Step one is to define the inductivity of the PFC choke and the MOSFET. After fixing PFC choke and transistor, two scenarios are happen:

1/ operation in **stable load** condition e.g. lamp ON / OFF

SET nominal load condition and vary the value of the resistor until you get the best THD results. Outcome sees in Figure 11 black curve

2/ operation with **load variation** e.g. dimming of an LED

Choose a resistor and vary the load. Change value up or down in order to get your best result over the whole load range – outcome sees Figure 11 red curve.

Key Measurements and Waveforms

Mechanism:

The controller operates in two modes:

- Critical Conduction Mode (CrCM) in a wide load range
- Wait Cycle Mode (WCM – a kind of DCM) for low load

Switch from CrCM into WCM):

The ICL5101 has an integrated logic which can be regulated via the resistor at the ZCD PIN 7 in varying the value of the resistor.

Limit:

The digital logic of the controller is limited. At high line input voltages, the controller reduces the ON time of the PFC gate driver. If the minimum ON time is reached – physically given by the internal digital stage – the controller switches over from the critical conduction mode CrCM into the wait cycle mode WCM. This switch over can be seen in the THD measurement shown in Figure xx. Depending on the load (stable or variable) the optimum configuration can be found, shown in . This effect can be prevented by trimming the resistor at the ZCD PIN 7 – lower the resistance leads to a smother cross over from CrCM into WCM (red curve) but increases slightly the THD.

Key Measurements and Waveforms

4.2 Surge Protection

Description SURGE Protection

In case of a surge event, the voltage at the BUS capacitors C5 & C8 rises up, the driver stages of the ICL5101 are shut off when $V_{LSCS} > 0.8V$ and $V_{BUS} > 109\%$ for longer than 500ns. After the surge the controller restarts automatically when V_{BUS} drops below 109% of the rated voltage. This feature allows driving 500V MOSFETs at the half bridge stage when adequate EMI and DC LINK networking is present.

SURGE Detection

If the bus voltage exceeds:

$$V_{BUS} > 109\%$$

and the voltage at the low side current sense pin 2 exceeds:

$$V_{LSCS} > 0.8V$$

for longer than

$$t = 500ns$$

SURGE Protection

All Gate Drives OFF

Auto Restart:

$$V_{BUS} < 109\%$$

Measurement

Surge Event of 1.7kV WITHOUT Varistor VR1

Figure 13: SURGE 1.7kV / FULL Load / Detail
 L → N / Phase: 90°
 Ch 1 dark blue: V_{LSCS} LS Current Sense to IC GND
 Ch 2 blue: V_{BUS} to Power GND
 Ch 3 magenta: V_{LSDS} LS Drain to Power GND
 Ch 4 green: V_{PFCDS} PFC Drain to Power GND

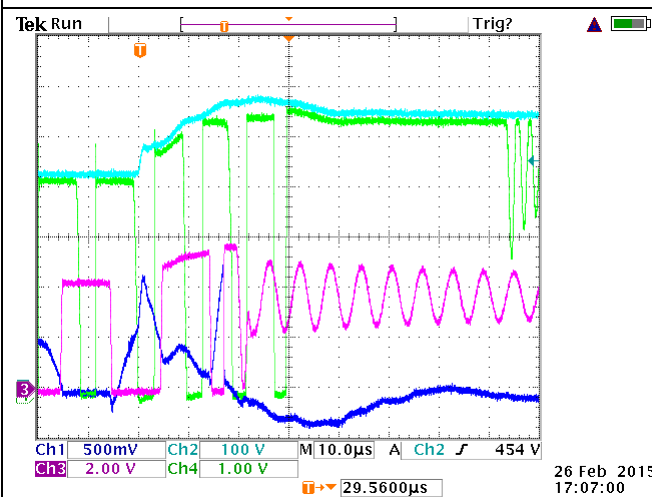
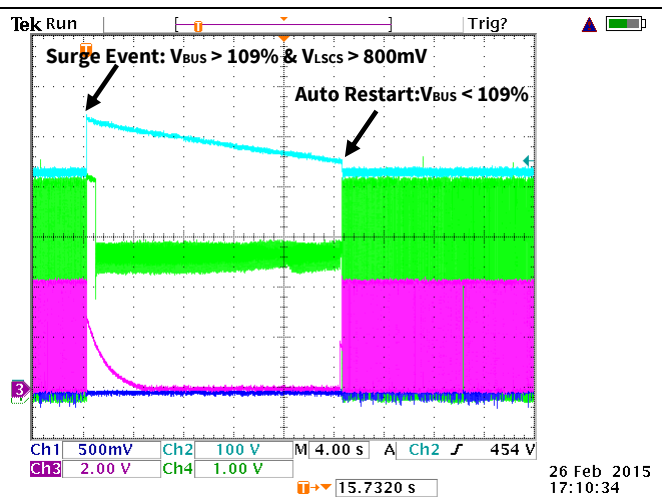

Figure 14: SURGE 1.7kV / FULL Load / Auto Restart
 L → N / Phase: 90°
 Ch 1 dark blue: V_{LSCS} LS Current Sense to IC GND
 Ch 2 blue: V_{BUS} to Power GND
 Ch 3 magenta: V_{LSDS} LS Drain to Power GND
 Ch 4 green: V_{PFCDS} PFC Drain to Power GND



Key Measurements and Waveforms

4.3 Harmonics

Harmonics are tested according to the standard EN61000-3-2 Class-D, as shown in the following figures.

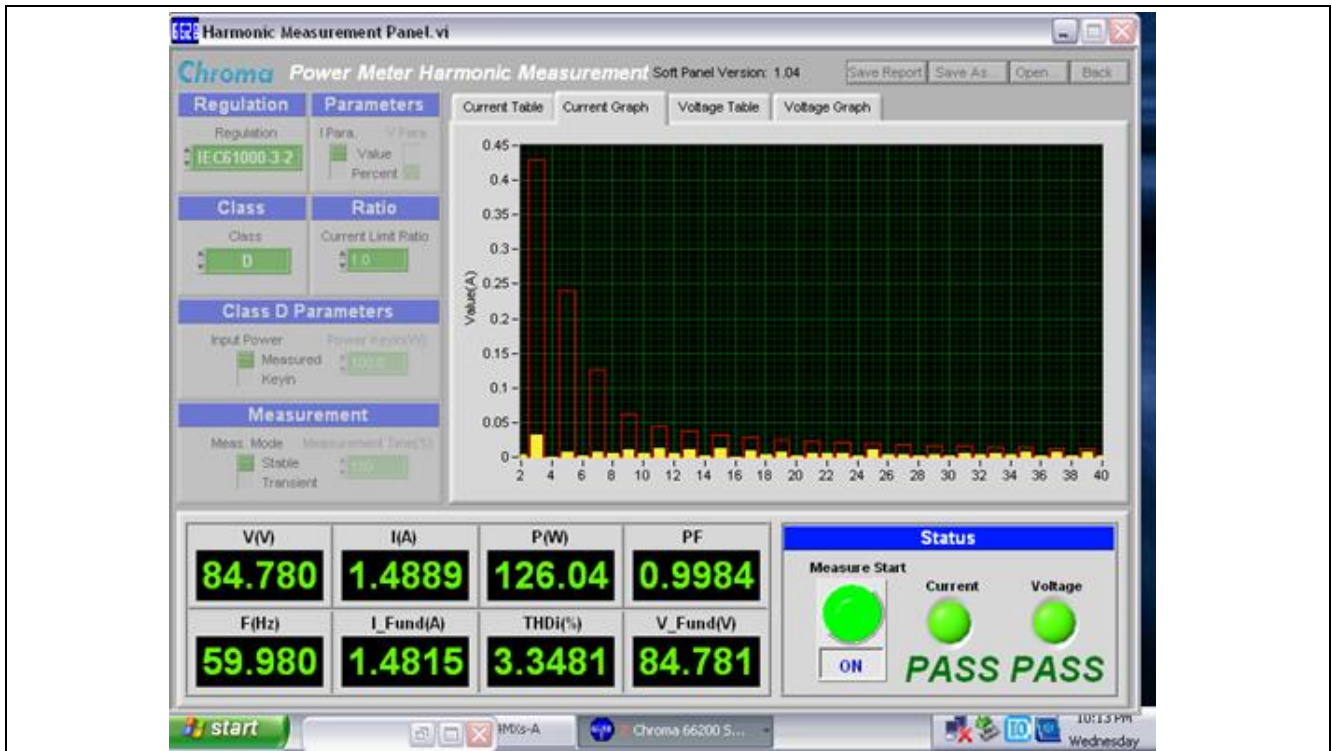

Figure 15 Input Current Harmonic Spectrum at Full Load and $V_{IN} = 85 \text{ V AC}$

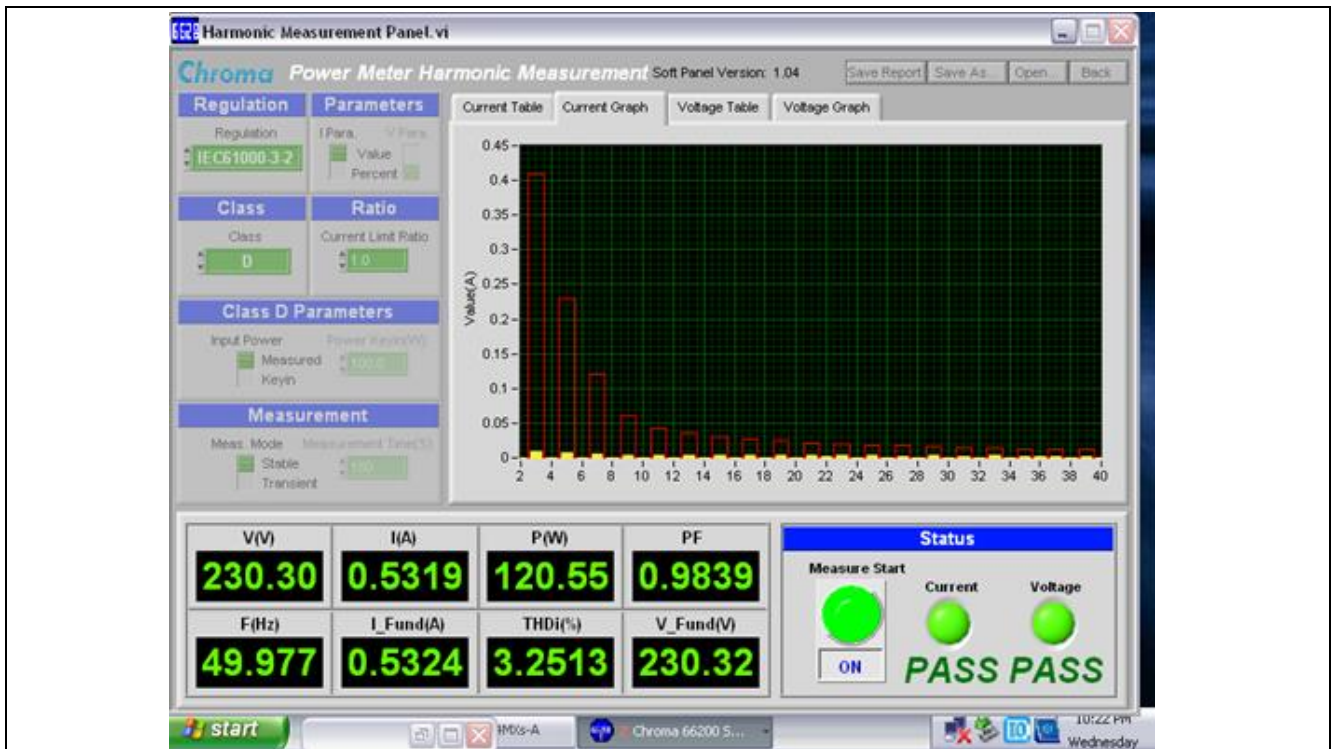

Figure 16 Input Current Harmonic Spectrum at Full Load and $V_{IN} = 230 \text{ V AC}$

Key Measurements and Waveforms

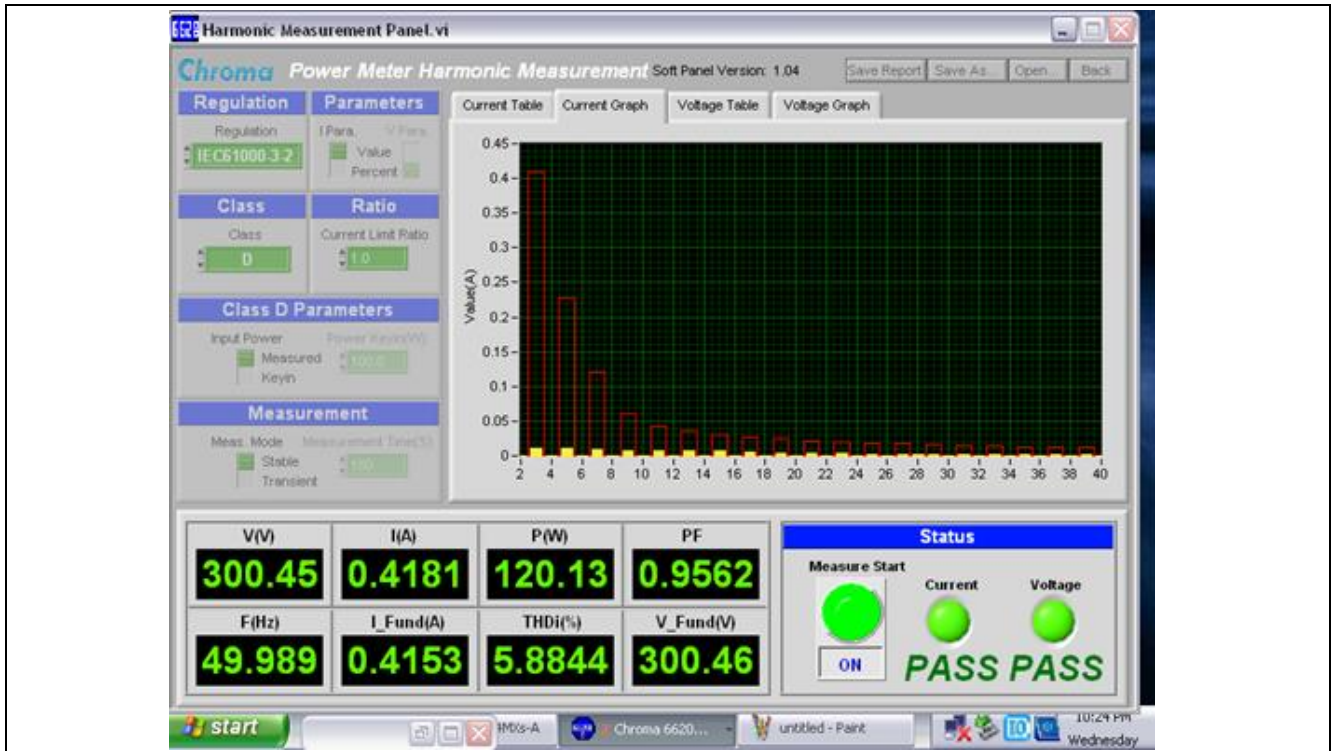

Figure 17 Input Current Harmonic Spectrum at Full Load and $V_{IN} = 300$ VAC

4.4 System Efficiency and Standby Power

4.4.1 System Efficiency

The efficiency of the demo board is tested at 230 VAC input voltage and under different output power from 0 W to 110 W.

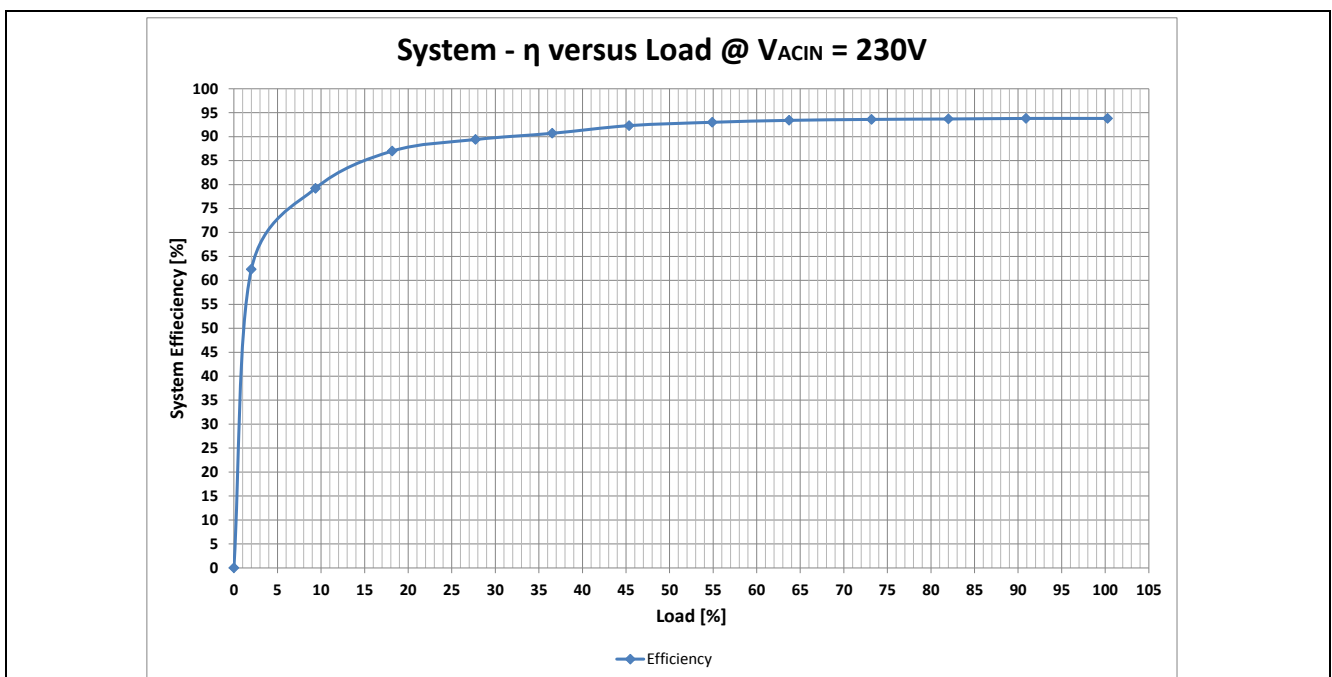

Figure 18 System Efficiency versus Load

Key Measurements and Waveforms

4.4.2 Power Consumption at Output Open Loop (Standby Power)

At output open loop (NO Load), the power converter keeps the output voltage at a stable value of 54 V and will not go into burst mode.

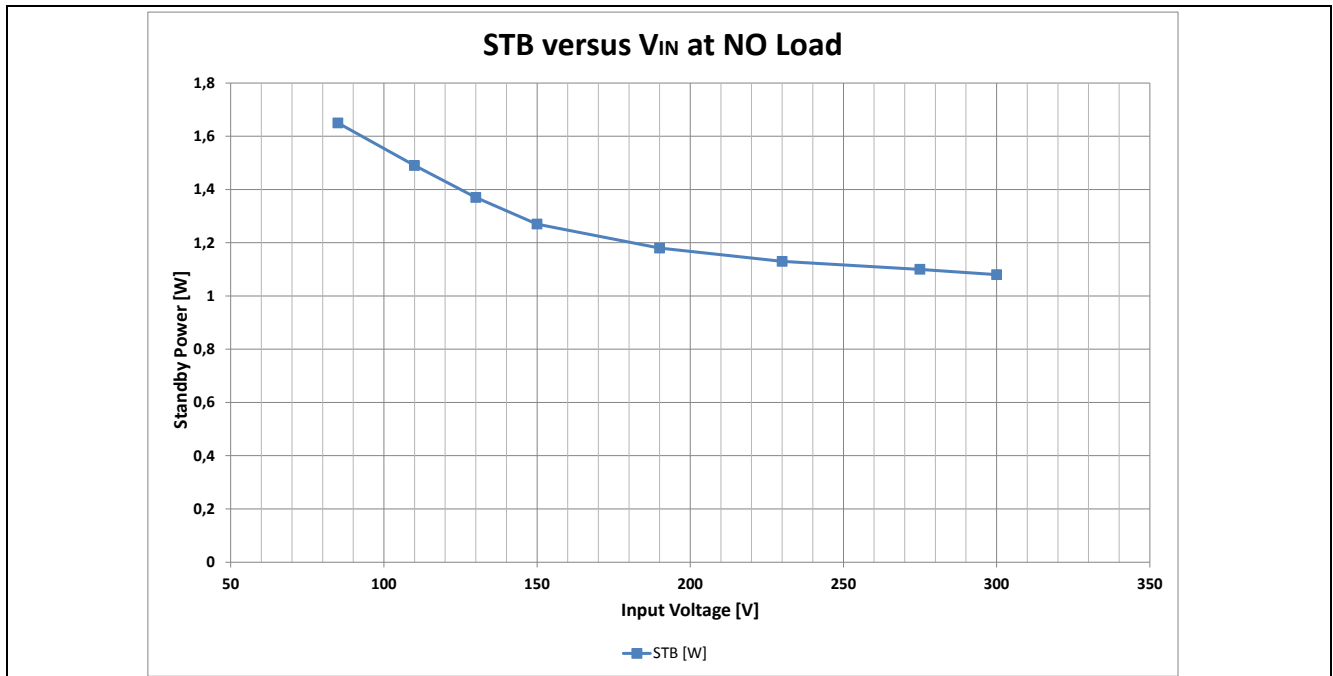
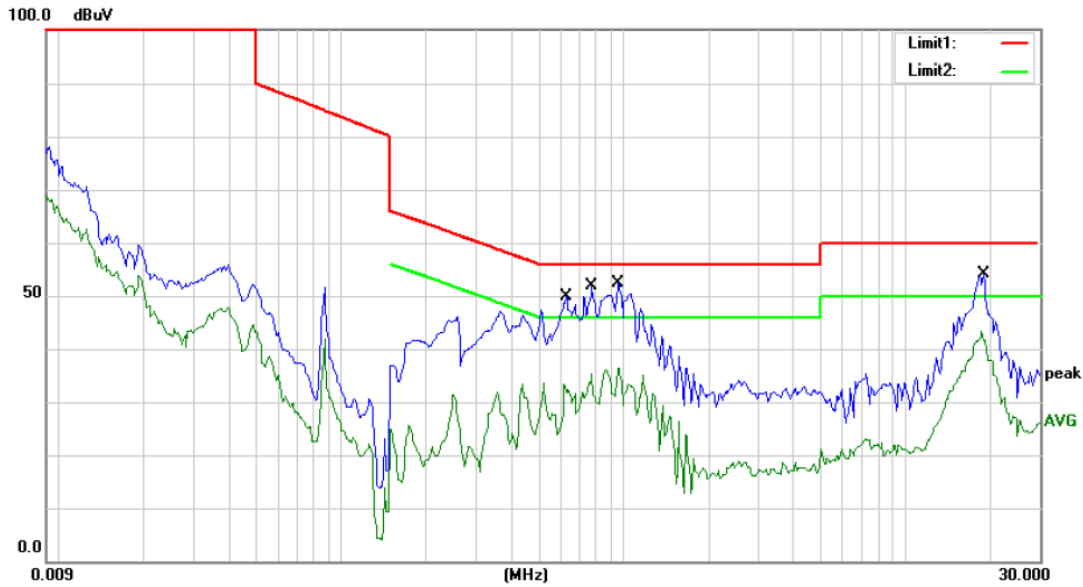

Figure 19 Standby Power versus V_{AC}

Key Measurements and Waveforms

4.5 EMI Test

Conducted EMI and radiated EMI are tested according to the standard EN55015.



Site Conduction #1 Phase: **N** Temperature: 24
 Limit: (CE)EN55015_QP Power: AC 230V/50Hz Humidity: 53 %

Figure 20 Conducted EMI -- 230VAC/50Hz N

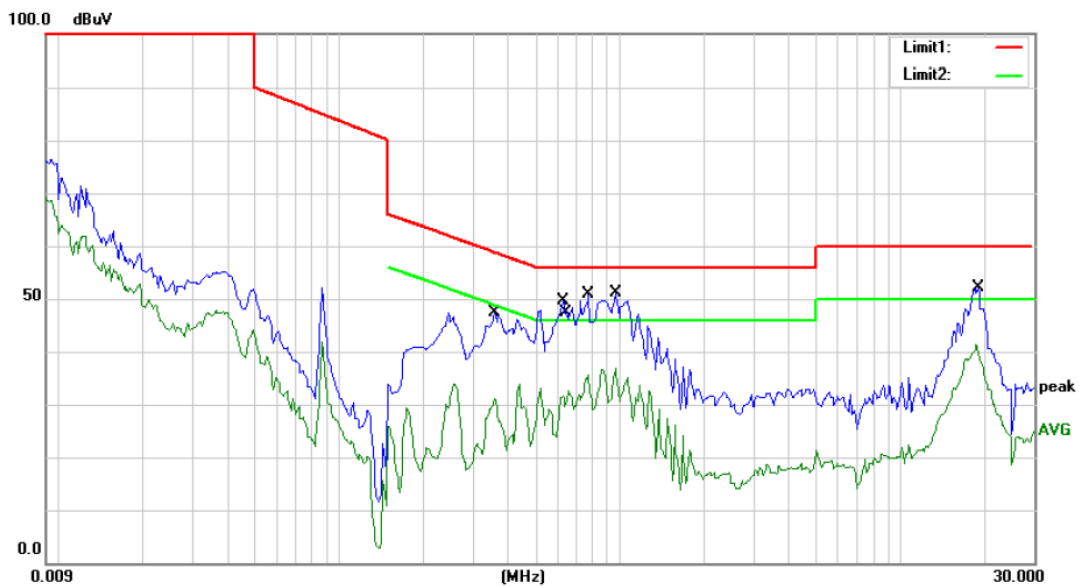

Site Conduction #1 Phase: **L1** Temperature: 24
 Limit: (CE)EN55015_QP Power: AC 230V/50Hz Humidity: 53 %

Figure 21 Conducted EMI -- 230VAC/50Hz L

Key Measurements and Waveforms

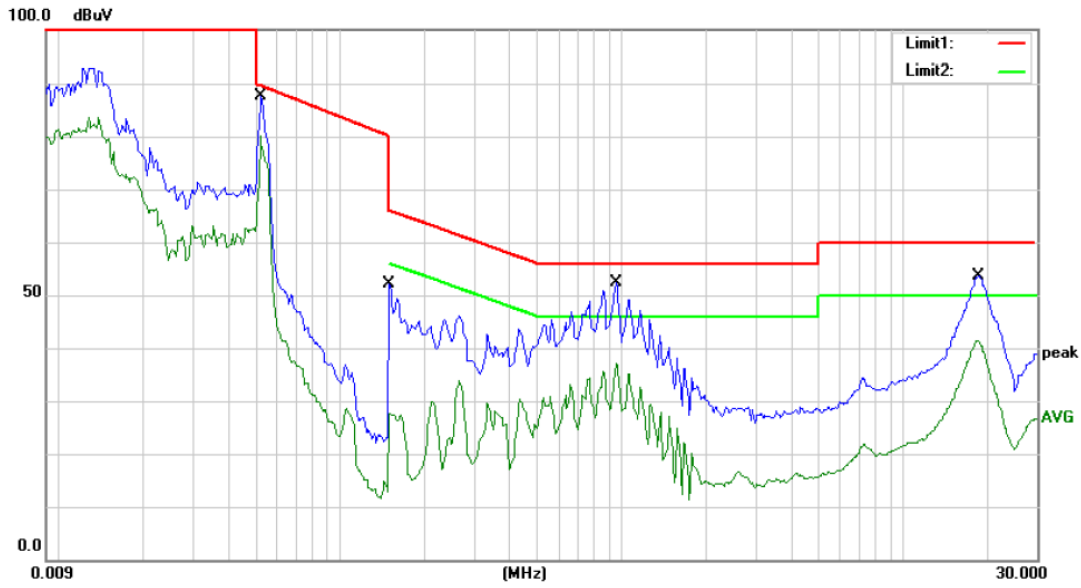

Site Conduction #1 Phase: **N** Temperature: 24
 Limit: (CE)EN55015_QP Power: AC 120V/60Hz Humidity: 53 %

Figure 22 Conducted EMI -- 120VAC/60Hz N

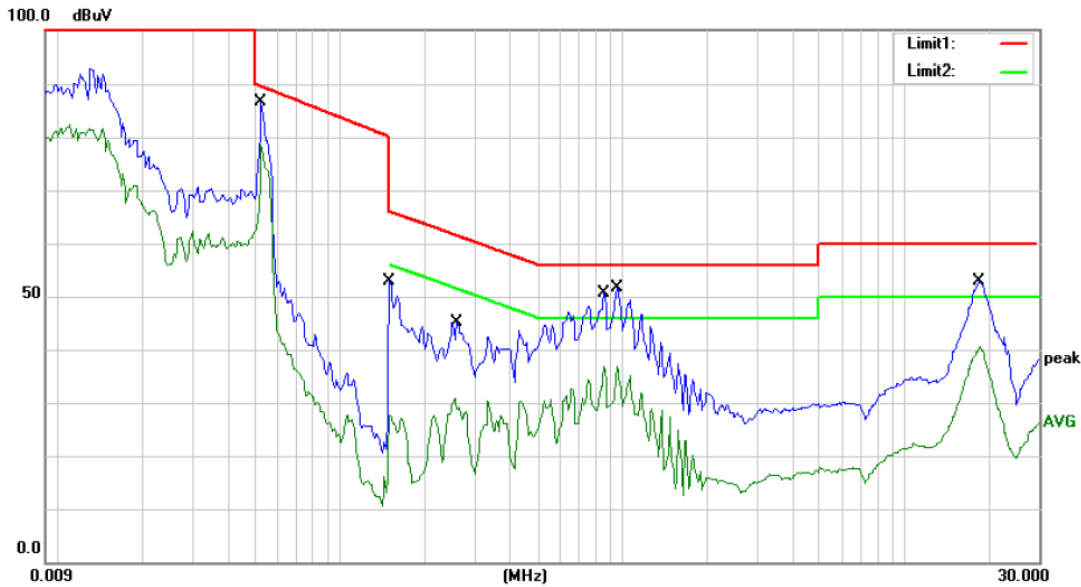

Site Conduction #1 Phase: **L1** Temperature: 24
 Limit: (CE)EN55015_QP Power: AC 120V/60Hz Humidity: 53 %

Figure 23 Conducted EMI -- 120VAC/60Hz L

Key Measurements and Waveforms

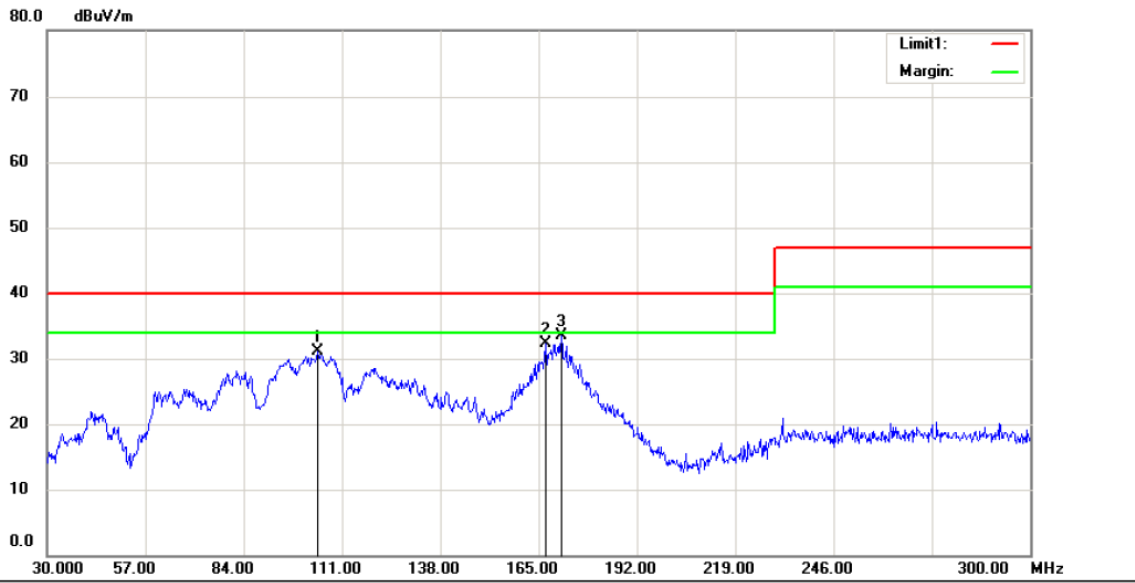

Site 3m Chamber #1 Polarization: **Horizontal** Temperature: 24 C
 Limit: (RE)EN55022 class B Power: AC 230V/50Hz Humidity: 53 %

Figure 24 Radiated EMI -- 230VAC/50Hz Horizontal

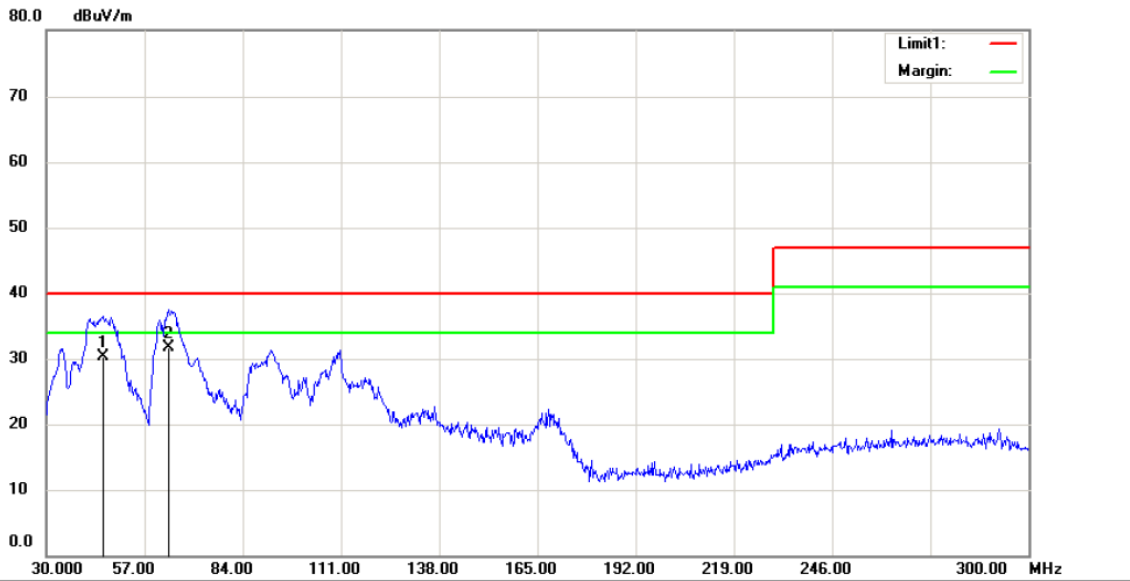

Site 3m Chamber #1 Polarization: **Vertical** Temperature: 24 C
 Limit: (RE)EN55022 class B Power: AC 230V/50Hz Humidity: 53 %

Figure 25 Radiated EMI -- 230VAC/50Hz Vertical

Key Measurements and Waveforms

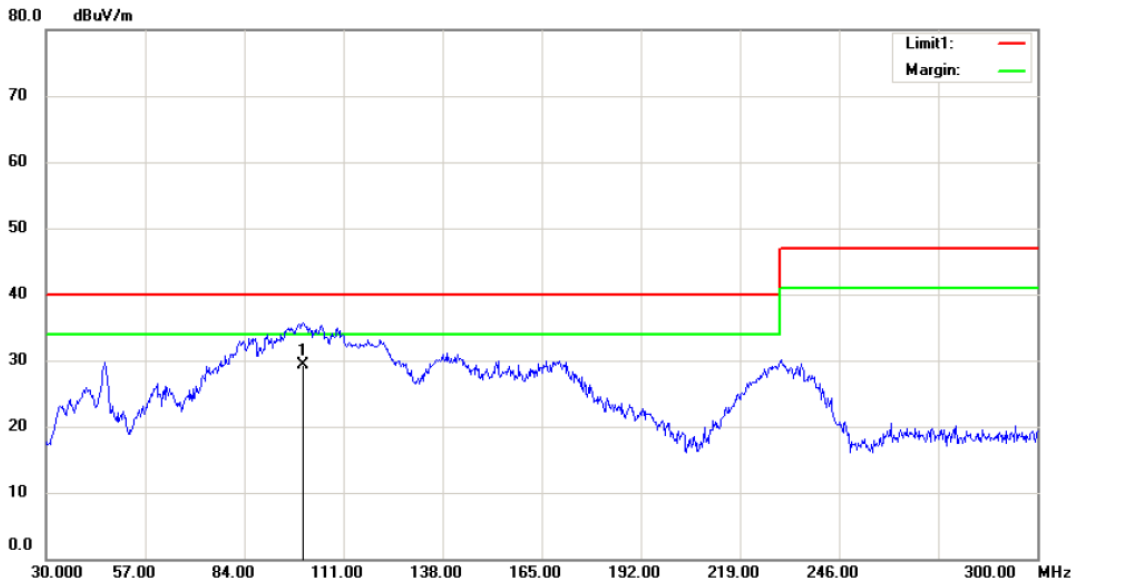

Site 3m Chamber #1 Polarization: **Horizontal** Temperature: 24 C
 Limit: (RE)EN55022 class B Power: AC 120V/60Hz Humidity: 53 %

Figure 26 Radiated EMI -- 120VAC/60Hz Horizontal

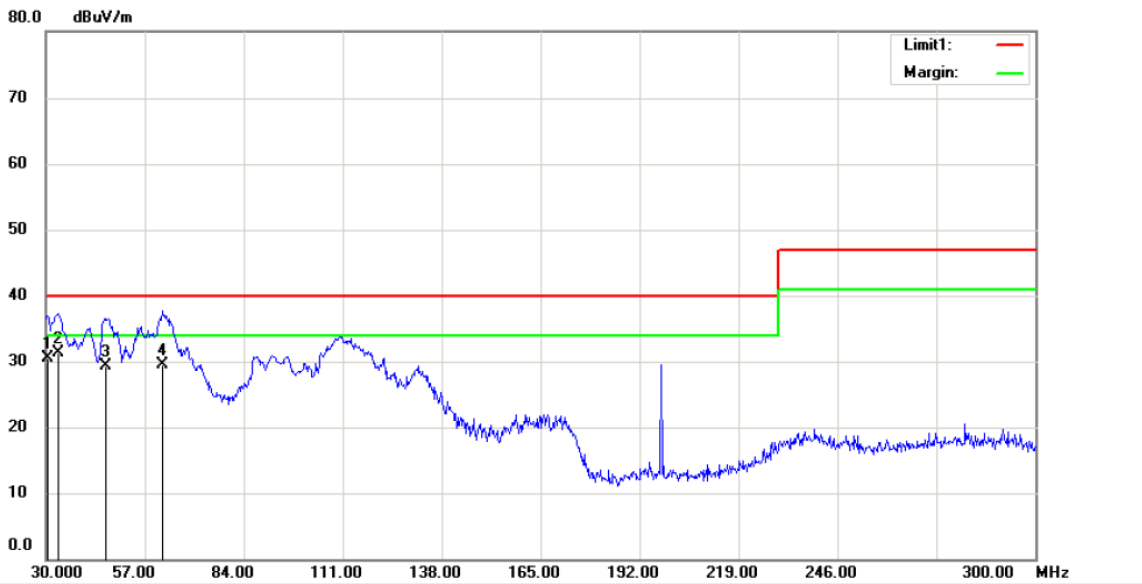

Site 3m Chamber #1 Polarization: **Vertical** Temperature: 24 C
 Limit: (RE)EN55022 class B Power: AC 120V/60Hz Humidity: 53 %

Figure 27 Radiated EMI -- 120VAC/60Hz Vertical



Surge, Flicker & Burst Test Results

5 Surge, Flicker & Burst Test Results

5.1 Surge

深圳信测标准技术服务股份有限公司
 深圳市南山区马家龙工业区69栋(518052)
 www.emtek.com.cn Tel: +86-755-2695 4280 Fax: +86-755-2695 4282



Surge Immunity Test Data

APPLICATION No: _____

APPLICANT: Finepower

DESCRIPTION OF SAMPLE(S)

Product: 电源
 Brand Name:
 Model Number(s): 110W/54V LED DRIVER
 Rating:

Prepared By: KY
 Reviewed By:
 Date: 2015-1-26
 Test Result: Pass
 Fail

Test Specification: _____ Test Method: IEC61000-4-5 ANSI C62.41/45
 Performance Criterion accepted by Test Specification: A B C
 Operation Mode: _____ FULL LOAD

Conductor Under Test	Test Level	Count	Phase Angle	Surge Interval	Result *
<input checked="" type="checkbox"/> L-N <input checked="" type="checkbox"/> L-PE <input checked="" type="checkbox"/> N-PE	<input type="checkbox"/> ±0.5kV <input type="checkbox"/> ±1.0kV <input checked="" type="checkbox"/> ±2.0kV <input type="checkbox"/> ±4.0kV <input type="checkbox"/> ±6kV	<input checked="" type="checkbox"/> 5 <input type="checkbox"/> _____	<input type="checkbox"/> 0° <input checked="" type="checkbox"/> 90° <input type="checkbox"/> 180° <input checked="" type="checkbox"/> 270°	<input checked="" type="checkbox"/> 60s <input type="checkbox"/> _____ s	<input type="checkbox"/> A <input checked="" type="checkbox"/> B <input type="checkbox"/> C <input type="checkbox"/> D
<input type="checkbox"/> L-N <input type="checkbox"/> L-PE <input type="checkbox"/> N-PE	<input type="checkbox"/> ±0.5kV <input type="checkbox"/> ±1.0kV <input type="checkbox"/> ±2.0kV <input type="checkbox"/> ±4.0kV <input type="checkbox"/> _____ kV	<input type="checkbox"/> 5 <input type="checkbox"/> _____	<input type="checkbox"/> 0° <input type="checkbox"/> 90° <input type="checkbox"/> 180° <input type="checkbox"/> 270°	<input type="checkbox"/> 60s <input type="checkbox"/> _____ s	<input type="checkbox"/> A <input type="checkbox"/> B <input type="checkbox"/> C <input type="checkbox"/> D
<input type="checkbox"/> L-N <input type="checkbox"/> L-PE <input type="checkbox"/> N-PE	<input type="checkbox"/> ±0.5kV <input type="checkbox"/> ±1.0kV <input type="checkbox"/> ±2.0kV <input type="checkbox"/> ±4.0kV <input type="checkbox"/> _____ kV	<input type="checkbox"/> 5 <input type="checkbox"/> _____	<input type="checkbox"/> 0° <input type="checkbox"/> 90° <input type="checkbox"/> 180° <input type="checkbox"/> 270°	<input type="checkbox"/> 60s <input type="checkbox"/> _____ s	<input type="checkbox"/> A <input type="checkbox"/> B <input type="checkbox"/> C <input type="checkbox"/> D
<input type="checkbox"/> Tx-Rx <input type="checkbox"/> Tx-PE <input type="checkbox"/> Rx-PE	<input type="checkbox"/> ±0.5kV <input type="checkbox"/> ±1.0kV <input type="checkbox"/> ±2.0kV <input type="checkbox"/> ±4.0kV <input type="checkbox"/> _____ kV	<input type="checkbox"/> 5 <input type="checkbox"/> _____		<input type="checkbox"/> 60s <input type="checkbox"/> _____ s	<input type="checkbox"/> A <input type="checkbox"/> B <input type="checkbox"/> C <input type="checkbox"/> D
<input type="checkbox"/> Tx-Rx <input type="checkbox"/> Tx-PE <input type="checkbox"/> Rx-PE	<input type="checkbox"/> ±0.5kV <input type="checkbox"/> ±1.0kV <input type="checkbox"/> ±2.0kV <input type="checkbox"/> ±4.0kV <input type="checkbox"/> _____ kV	<input type="checkbox"/> 5 <input type="checkbox"/> _____		<input type="checkbox"/> 60s <input type="checkbox"/> _____ s	<input type="checkbox"/> A <input type="checkbox"/> B <input type="checkbox"/> C <input type="checkbox"/> D

- * A: Normal performance within the specification limits
- B: Temporary degradation or loss of function or performance which is self-recoverable
- C: Temporary degradation or loss of function or performance which requires operator intervention or system reset
- D: Degradation or loss of function which is not recoverable due to damage of equipment (components) or software, or loss of data

Overall Result Classification & Comments:



Climatic Condition:

Relative Humidity: 51 % Ambient Temperature: 21 °C Atmospheric Pressure: 101 kPa

Equipment used:

- | | | | | |
|--|---------|-------------|--|-----------------|
| <input checked="" type="checkbox"/> In EMS Test Room | | | | |
| <input checked="" type="checkbox"/> Surge Controller | HAEFELY | Psurge 8000 | <input checked="" type="checkbox"/> Impulse Module | HAEFELY PIM 100 |
| <input checked="" type="checkbox"/> Coupling Module | HAEFELY | PCD 130 | <input checked="" type="checkbox"/> Impulse Module | HAEFELY PIM110 |
| <input checked="" type="checkbox"/> Coupling Module | HAEFELY | PCD122 | <input checked="" type="checkbox"/> Impulse Module | HAEFELY PIM 120 |
| <input checked="" type="checkbox"/> Coupling Module | HAEFELY | PCD 126A | | |

编号: TR-4-E-005 Rev:A/1



Surge, Flicker & Burst Test Results

5.2 Flicker

California Instruments
San Diego, California

1/21/2015
2:42 PM

Flicker Test Summary per EN/IEC61000-3-3 (Run time)

EUT:D1028
 Test category: All parameters (European limits) Tested by: KY
 Test date: 2015/1/21 Start time: 14:14:07 Test Margin: 100
 Test duration (min): 10 End time: 14:24:39
 Comment: ON Data file name: F-000087.cts_data
 Customer: FINEPOWER

Test Result: Pass Status: Test Completed

Pst, and limit line European Limits



Plt and limit line



Parameter values recorded during the test:

Vrms at the end of test (Volt):	229.75		
Highest dt (%):	0.00	Test limit (%):	3.30 Pass
Tmax(mS) > dt:	0	Test limit (mS):	500.0 Pass
Highest dc (%):	0.00	Test limit (%):	3.30 Pass
Highest dmax (%):	0.00	Test limit (%):	4.00 Pass
Highest Pst (10 min. period):	0.064	Test limit:	1.000 Pass
Highest Plt (2 hr. period):	0.028	Test limit:	0.650 Pass



Surge, Flicker & Burst Test Results

California Instruments
San Diego, California

1/21/2015
2:42 PM

Flicker Test Summary per EN/IEC61000-3-3 (Run time)

EUT: D1028
 Test category: All parameters (European limits)
 Test date: 2015/1/21
 Test duration (min): 10
 Comment: FULL LOAD
 Customer: FINEPOWER

Tested by: CSL
 Test Margin: 100
 Start time: 14:27:17
 End time: 14:37:48
 Data file name: F-000088.cts_data

Test Result: Pass Status: Test Completed

Pst, and limit line European Limits



Plt and limit line

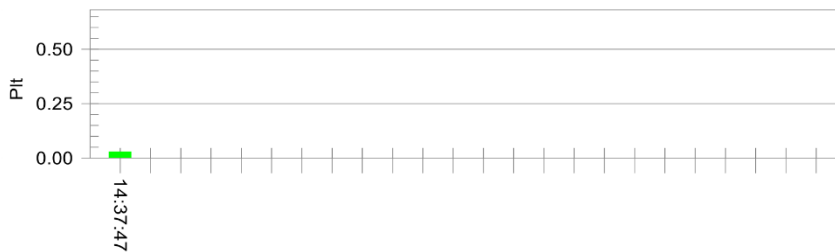

Parameter values recorded during the test:

Vrms at the end of test (Volt):	119.58		
Highest dt (%):	0.00	Test limit (%):	3.30 Pass
Tmax(mS) > dt:	0	Test limit (mS):	500.0 Pass
Highest dc (%):	0.00	Test limit (%):	3.30 Pass
Highest dmax (%):	0.00	Test limit (%):	4.00 Pass
Highest Pst (10 min. period):	0.064	Test limit:	1.000 Pass
Highest Plt (2 hr. period):	0.028	Test limit:	0.650 Pass



Surge, Flicker & Burst Test Results

5.3 Burst

深圳信测标准技术服务股份有限公司
 深圳市南山区马家龙工业区69栋(518052)
 www.emtek.com.cn Tel: +86-755-2695 4280 Fax: +86-755-2695 4282



EFT/B Immunity Test Data

APPLICATION No: _____
 APPLICANT: Finepower

DESCRIPTION OF SAMPLE(S)

Product: 电源
 Brand Name:
 Model Number(s): 110W/54V LED DRIVER
 Rating:
 Prepared By: CL
 Reviewed By:
 Date: 2015-1-26
 Test Result: Pass
 Fail
 Test Specification: _____ Test Method: EN61000-4-4 IEC61000-4-4
 Performance Criterion accepted by Test Specification: A B C
 Operation Mode: Refer to EMC Test Requirements Form FULL LOAD

Conductor Under Test	Test Level	Duration	Result *
<input checked="" type="checkbox"/> AC <input type="checkbox"/> DC <input type="checkbox"/> Signal <input type="checkbox"/> Control	<input type="checkbox"/> ±0.5kV <input checked="" type="checkbox"/> ±1.0kV <input type="checkbox"/> ±2.0kV <input type="checkbox"/> ±4.0kV <input type="checkbox"/> ±4.5 kV	<input checked="" type="checkbox"/> 120s <input type="checkbox"/>	<input checked="" type="checkbox"/> A <input type="checkbox"/> B <input type="checkbox"/> C <input type="checkbox"/> D
<input type="checkbox"/> AC <input type="checkbox"/> DC <input type="checkbox"/> Signal <input type="checkbox"/> Control	<input type="checkbox"/> ±0.5kV <input type="checkbox"/> ±1.0kV <input type="checkbox"/> ±2.0kV <input type="checkbox"/> ±4.0kV <input type="checkbox"/> kV	<input type="checkbox"/> 120s <input type="checkbox"/> s	<input type="checkbox"/> A <input type="checkbox"/> B <input type="checkbox"/> C <input type="checkbox"/> D
<input type="checkbox"/> AC <input type="checkbox"/> DC <input type="checkbox"/> Signal <input type="checkbox"/> Control	<input type="checkbox"/> ±0.5kV <input type="checkbox"/> ±1.0kV <input type="checkbox"/> ±2.0kV <input type="checkbox"/> ±4.0kV <input type="checkbox"/> kV	<input type="checkbox"/> 120s <input type="checkbox"/> s	<input type="checkbox"/> A <input type="checkbox"/> B <input type="checkbox"/> C <input type="checkbox"/> D
<input type="checkbox"/> AC <input type="checkbox"/> DC <input type="checkbox"/> Signal <input type="checkbox"/> Control	<input type="checkbox"/> ±0.5kV <input type="checkbox"/> ±1.0kV <input type="checkbox"/> ±2.0kV <input type="checkbox"/> ±4.0kV <input type="checkbox"/> kV	<input type="checkbox"/> 120s <input type="checkbox"/> s	<input type="checkbox"/> A <input type="checkbox"/> B <input type="checkbox"/> C <input type="checkbox"/> D
<input type="checkbox"/> AC <input type="checkbox"/> DC <input type="checkbox"/> Signal <input type="checkbox"/> Control	<input type="checkbox"/> ±0.5kV <input type="checkbox"/> ±1.0kV <input type="checkbox"/> ±2.0kV <input type="checkbox"/> ±4.0kV <input type="checkbox"/> kV	<input type="checkbox"/> 120s <input type="checkbox"/> s	<input type="checkbox"/> A <input type="checkbox"/> B <input type="checkbox"/> C <input type="checkbox"/> D
<input type="checkbox"/> AC <input type="checkbox"/> DC <input type="checkbox"/> Signal <input type="checkbox"/> Control	<input type="checkbox"/> ±0.5kV <input type="checkbox"/> ±1.0kV <input type="checkbox"/> ±2.0kV <input type="checkbox"/> ±4.0kV <input type="checkbox"/> kV	<input type="checkbox"/> 120s <input type="checkbox"/> s	<input type="checkbox"/> A <input type="checkbox"/> B <input type="checkbox"/> C <input type="checkbox"/> D

- * A: Normal performance within the specification limits
- B: Temporary degradation or loss of function or performance which is self-recoverable
- C: Temporary degradation or loss of function or performance which requires operator intervention or system reset
- D: Degradation or loss of function which is not recoverable due to damage of equipment (components) or software, or loss of data

Overall result Classification & Comments:

Climatic Condition:
 Relative Humidity: 55 % Ambient Temperature: 23 Atmospheric Pressure: 100 kPa

Equipment used:
 In EMS Test Room
 Burst Tester HAEFELY PEFT4010
 Coupling Clamp HAEFELY IP-4A



编号: TR-4-E-004 Rev:A/1

Power Transformer Specification

6 Power Transformer Specification

6.1 Common Mode Choke Spec L1

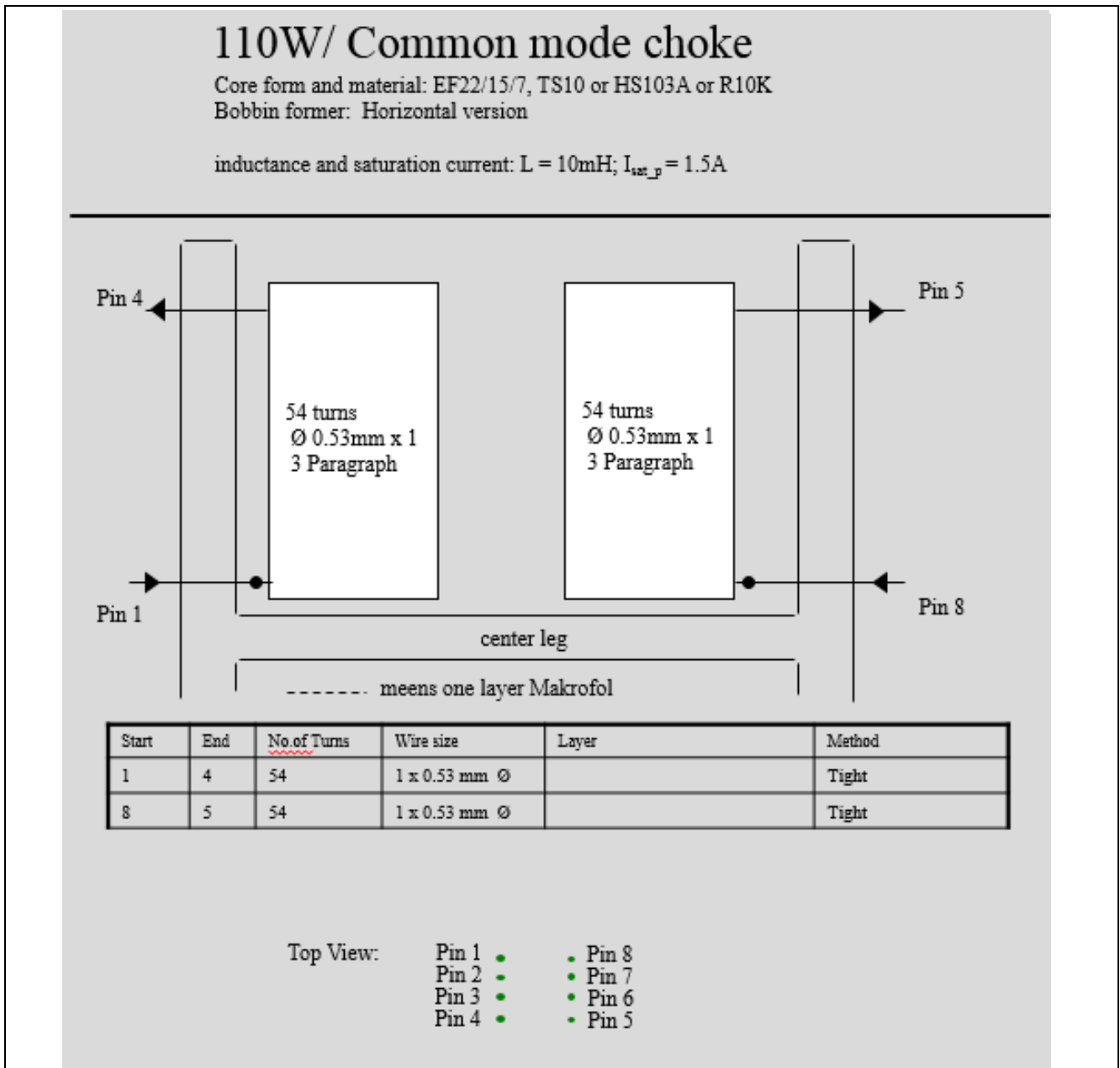

Figure 28 Common Mode Choke

Power Transformer Specification

6.2 PFC Choke Spec T1

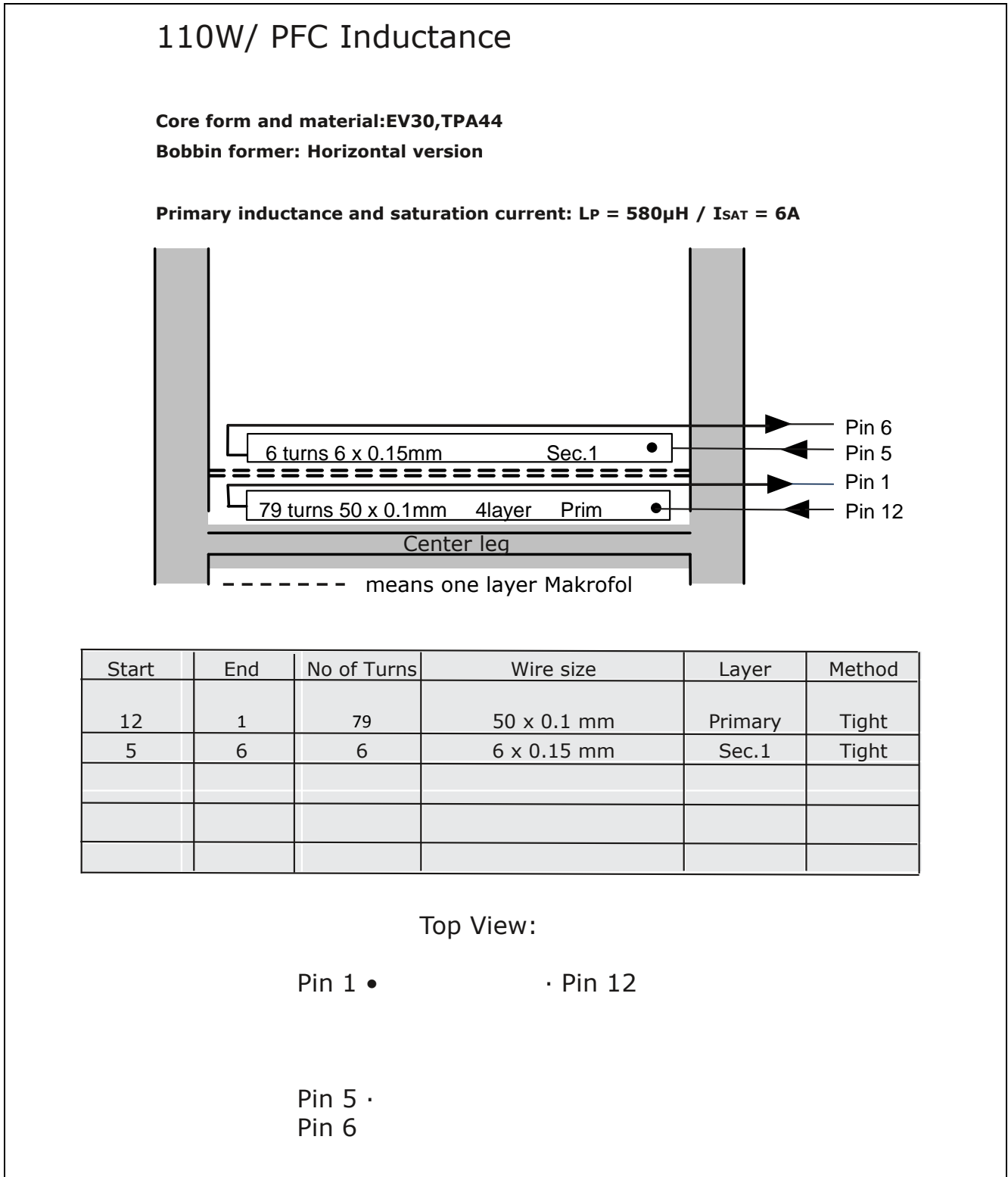

Figure 29 PFC Choke

Power Transformer Specification

6.3 LLC Resonant Choke Spec L2

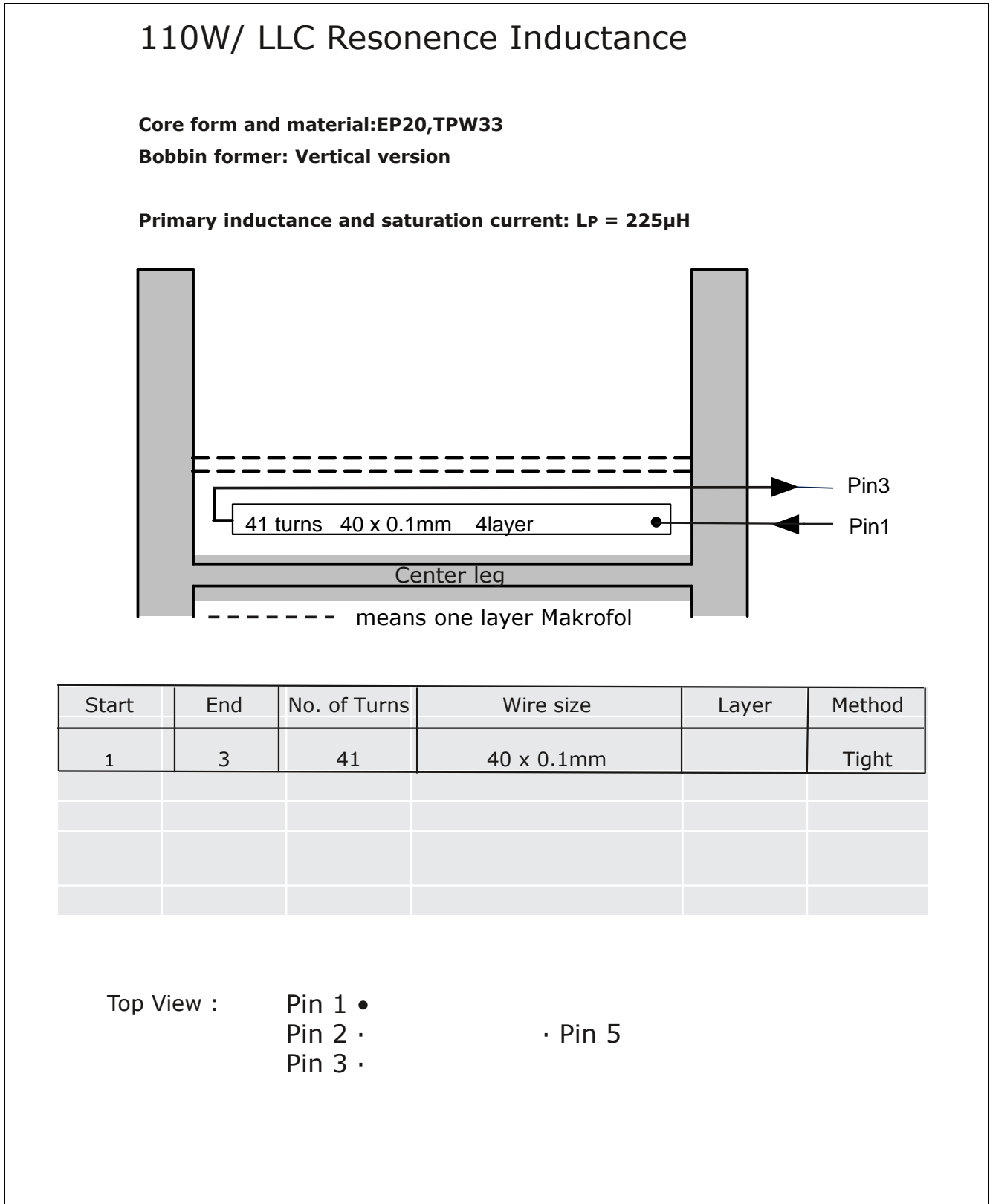

Figure 30 LLC Resonant Choke

Power Transformer Specification

6.4 LLC Transformer Spec T2

110W/LLC transformer

Core form and material: ED26/7/30, TPW33

Bobbin former: Horizontal version

Primary inductance : $L_P = 2700\mu H$

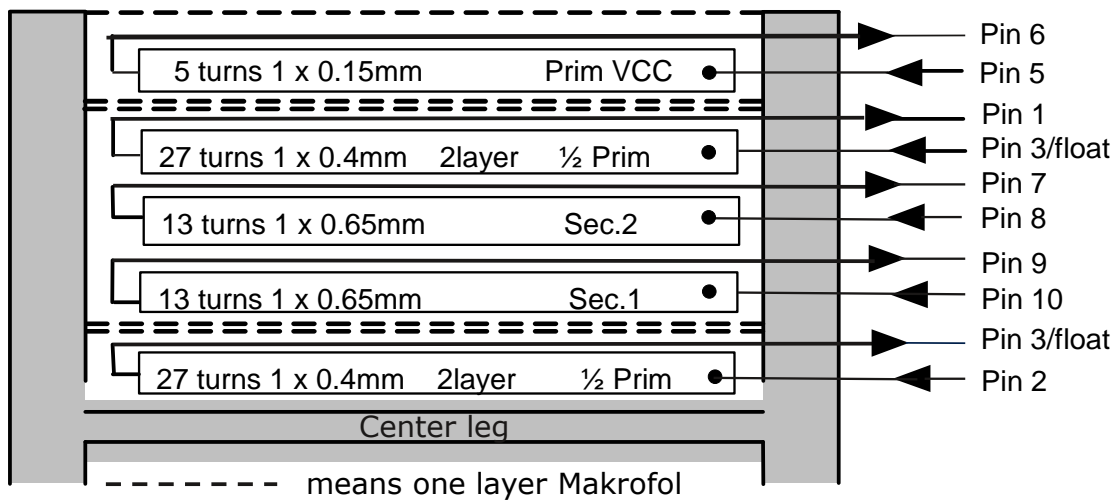

Start	End	No of Turns	Wire size	Layer	Method
2	3 / flox	27	0.4mm	1/2 Primary	Tight
10	9	13	0.65mm, tripple isolation	Sec.1	Tight
8	7	13	0.65mm, tripple isolation	Sec.2	Tight
3 / float	1	27	0.4mm	1/2 Primary	Tight
5	6	5	0.15mm	VCC	spread

Top View:



Figure 31 LLC Transformer

Board Layout

7 Board Layout

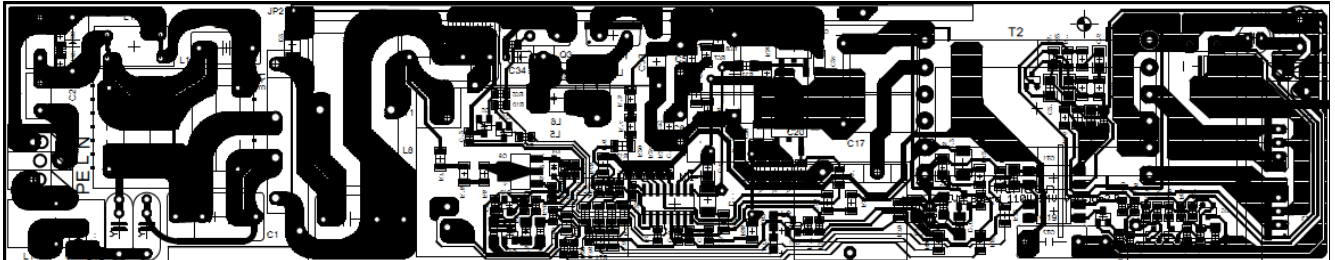

Figure 32 Layout of 110 W / 54 V Power Supply Demo Board (Bottom View)

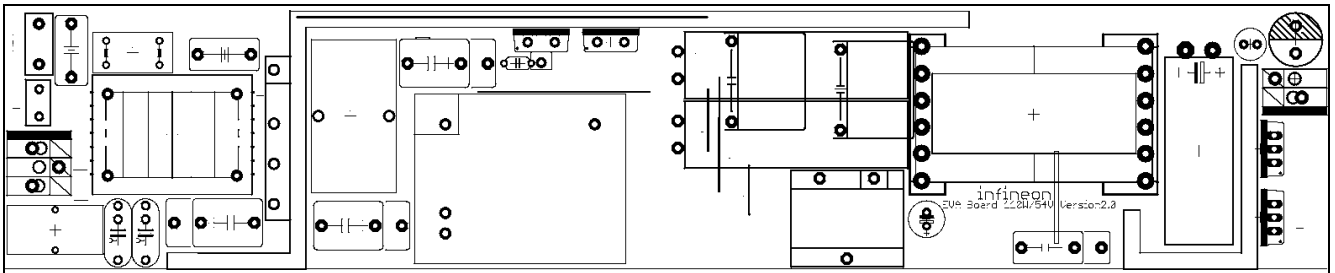

Figure 33 Assembly Print (Top View)

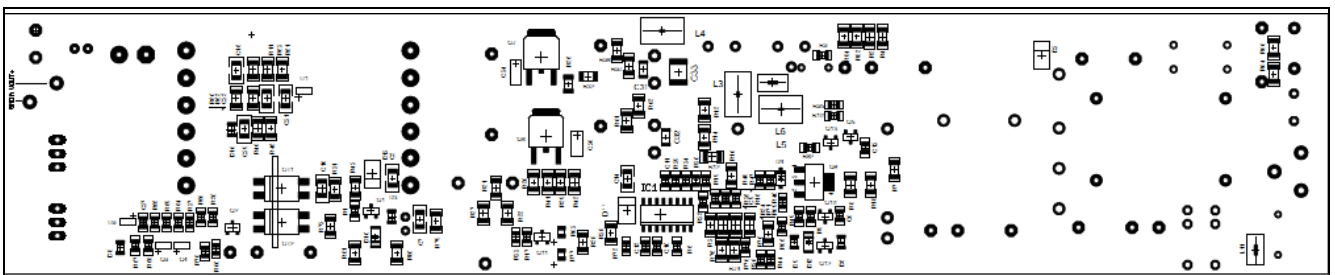

Figure 34 Assembly Print (Bottom View)

Bill of Material (BOM)

8 Bill of Material (BOM)

Designator	Part Value	Description	Packag/Footprint	Supplier	Order Number
BR1	LL15XB60	bridge, 15A/600V	GSIB-5S	SHINDENGEN	LL15XB60
C1	330nF/305V/X2	305V/X2 capacitor	FCAP-18-9-15/10	EPCOS	BS2922C3334M
C10	100nF/50V	ceramic capacitor	C0805		
C11	22nF/50V	ceramic capacitor	C0805		
C12	100nF/50V	ceramic capacitor	C0805		
C13	100pF/50V	ceramic capacitor	C0805		
C14	100nF/50V	ceramic capacitor	C1206		
C15	4n7/50V	ceramic capacitor	C1206		
C16	220nF/50V	ceramic capacitor	C1206		
C17	33nF/630V	film capacitor	FCAP-18-6-12-15-H	EPCOS	B32672L6333K
C18	100uF/35V	Aluminium Electrolyte	EUE2.5-7	RUBYCON	RUBYCON
C19	2n2/400V/Y2	400V/Y2 capacitor	FCAP-18-6-15/10		
C2	100nF/305V/X2	305V/X2 capacitor	FCAP-13-6-10	EPCOS	B32921C3104M
C20	150nF/520V	film capacitor	FCAP-18-6-12-15-H	EPCOS	B32672Z5154K
C21	220nF/50V	ceramic capacitor	C1206		
C22	330uF/100V	Aluminium Electrolyte	EUE5-B12,5-L35	RUBYCON	100ZLJ330M12.5X35
C23	100pF/50V	HV ceramic capacitor	C1206		
C24	100pF/630V	HV ceramic capacitor	C1206		
C25	100uF/100V	Aluminium Electrolyte	ECAP-10-5	RUBYCON	100ZLJ100M10X20
C26	100pF/630V	ceramic capacitor	C1206		
C27	1nF/50V	ceramic capacitor	C0805		
C28	100nF/305V/X2	305V/X2 capacitor	FCAP-18-9-15/10	EPCOS,	B32921C3104M
C29	100nF/50V	ceramic capacitor	C1206		
C3	2u2/50V	ceramic capacitor	C1206		
C30	470nF/630V	film capacitor	FCAP-18-6-15/10	EPCOS	B32922
C31	10nF/630V	HV ceramic capacitor	C1206		
C32	10nF/630V	HV ceramic capacitor	C1206		
C33	100nF/630V	HV ceramic capacitor	C1812		
C34	47pF/1kV	HV ceramic capacitor	C050-024x044		
C4	470nF/630V	film capacitor	FCAP-18-6-15/10	EPCOS	B32652A6224K
C5	150uF/250V	Aluminium Electrolyte	ECAP-12.5-5-H	NICHICON	UCY2E151MHD6
C6	100nF/50V	ceramic capacitor	C0805		
C7	2u2/50V	ceramic capacitor	C1206		
C8	150uF/250V	Aluminium Electrolyte	ECAP-12.5-5-H	NICHICON	UCY2E151MHD6
C9	2n2/50V	ceramic capacitor	C0805		
CY1	2n2/400V/Y2	400V/Y2 capacitor	FCAP-18-6-15/10		
CY2	2n2/400V/Y2	400V/Y2 capacitor	FCAP-18-6-15/10		
D1	8ETL06PBF	rectification diode	TO220-2	VISHAY	8ETL06PBF
D10	1N4148	small single switch diode	SOD-123_MINI-SM		
D11	MURS160	rectification diode	SMA	ON	ON
D12	SS210	rectification diode	SMA	VISHAY	VISHAY
D13	1N4148	small single switch diode	SOD-123_MINI-SM		
D14	V10150C	rectification diode	TO220	VISHAY	V10150C
D15	V10150C	rectification diode	TO220	VISHAY	V10150C
D16	BZT52C9V1	Zener diode	SOD-123_MINI-SM		
D2	S2JA	rectification diode	SMA	diodes	diodes
D3	BZT52C16	Zener diode	SOD-123_MINI-SM		

Bill of Material (BOM)

D4	BZT52C16	Zener diode	SOD-123_MINI-SM		
D5	BZT52C13	Zener diode	SOD-123_MINI-SM		
D8	BZT52C15	Zener diode	SOD-123_MINI-SM		
D9	BZT52C8V2	Zener diode	SOD-123_MINI-SM		
F1	3.15A/300V	fuse	FUSE8.5-4		
IC1	ICL5101	control IC	SOP16	INFINEON	ICL5101
L1	2x10mH CM choke	CM inductance	EMI_CHOKE_14,5X24,5EF16LONG	ICT	NP2014-9132
L11	B core	bead	WE-CBF_1812	WÜRTH	742792515
L12	2X1mH/2A CM choke	CM choke	WE-CMB_XS	WÜRTH	744821201
L14	470uH/1A inductance	inductance	FERRITE_R16	WÜRTH	7447010
L2	IND_EF20	inductance	EF20	ICT	NP2014-9133
L3	B core	bead	WE_PBF_7427932	WÜRTH	7427932
L4	B core	bead	WE_PBF_7427932	WÜRTH	7427932
L5	B core	bead	WE_PBF_7427932	WÜRTH	7427932
L6	B core	bead	1812	WÜRTH	742792515
L7	4.7uH/3.7A inductance	inductance	5070	WÜRTH	7447462047
L8	860uH/3A inductance	inductance	WE_7447075	WÜRTH	7447075
OT1	VOL617A-3	optocoupler	DIL4-SMD	VISHAY	VOL617A-3
OT2	VOL617A-3	optocoupler	DIL4-SMD	VISHAY	VOL617A-3
Q1	PMMT491	NPN transistor	SOT23		
Q10	KST2222	NPN transistor	SOT23		
Q11	KST2222	NPN transistor	SOT23		
Q12	KST2907	NPN transistor	SOT23		
Q13	KST2222	NPN transistor	SOT23		
Q2	KST5551MTF	NPN transistor	SOT23		
Q3	IPP60R125C6	N MOSFET	TO220	INFINEON	IPP60R125C6
Q4	2N7002	N MOSFET	SOT23		
Q5	KST2907	PNP transistor	SOT23		
Q6	2N7002	N MOSFET	SOT23		
Q7	IPD60R450E6	N MOSFET	TO252	INFINEON	IPD60R450E6
Q8	IPD60R450E6	N MOSFET	TO252	INFINEON	IPD60R450E6
Q9	BSP135	depletion MOSFET	SOT223	INFINEON	BSP135
R1	10k	film resistor	R0805		
R10	4R99	film resistor	R0805		
R11	2K	film resistor	R1206		
R12	562K	film resistor	R1206		
R13	2M	film resistor	R1206		
R14	2M	film resistor	R1206		
R15	25K5	film resistor	R0805		
R16	0R	film resistor	R1206		
R17	10k	film resistor	R0805		
R18	2K21	film resistor	R1206		
R19	12k1	film resistor	R0805		
R2	51k1	film resistor	R1206		
R20	n.c.	film resistor	R0805		
R21	0R	film resistor	R1206		
R22	133k	film resistor	R0805		
R23	9k1	film resistor	R0805		
R24	0R0	film resistor	R0805		
R25	47k5	film resistor	R0805		
R26	0R	film resistor	R0805		



Bill of Material (BOM)

R27	4M02	film resistor	R0805		
R28	10R	film resistor	R1206		
R29	0R	film resistor	R0805		
R3	0R68	film resistor	R1206		
R30	33K	film resistor	R0805		
R31	22R	film resistor	R1206		
R32	22R	film resistor	R1206		
R33	n.c.	film resistor	R1206		
R34	0R0	film resistor	R1206		
R35	10k	film resistor	R1206		
R36	10k	film resistor	R1206		
R37	n.c.	film resistor	R1206		
R38	1K	film resistor	R1206		
R39	1R5	film resistor	R1206		
R4	0R68	film resistor	R1206		
R40	35R	film resistor	R0805		
R41	1R5	film resistor	R1206		
R42	2R	film resistor	R1206		
R43	2R0	film resistor	R1206		
R44	10K	film resistor	R0805		
R45	30K	film resistor	R1206		
R46	680R	film resistor	R1206		
R47	10K	film resistor	R0805		
R48	10K	film resistor	R0805		
R49	100R	film resistor	R0805		
R5	0R0	film resistor	R0805		
R50	7K5	film resistor	R1206		
R51	20K	film resistor	R1206		
R52	127K	film resistor	R1206		
R53	34K	film resistor	R1206		
R54	221K	film resistor	R0805		
R55	51K	film resistor	R0805		
R56	464K	film resistor	R0805		
R57	200K	film resistor	R0805		
R58	182K	film resistor	R0805		
R59	830K	film resistor	R0805		
R6	10k	film resistor	R0805		
R60	150K	film resistor	R0805		
R61	1M	film resistor	R1206		
R62	680R	PTC	R0805	EPCOS	B59701A0100A062
R63	1M	film resistor	R1206		
R64	n.c.	film resistor	R1206		
R65	15R	film resistor	R0805		
R66	n.c.	film resistor	R1206		
R67	1M	film resistor	R1206		
R68	1M	film resistor	R1206		
R69	0R	film resistor	R1206		
R7	2k21	film resistor	R1206		
R70	0R	film resistor	R1206		
R71	0R	film resistor	R1206		
R72	0R	film resistor	R1206		
R73	0R	film resistor	R0805		



Bill of Material (BOM)

R74	0R	film resistor	R1206		
R75	0R	film resistor	R1206		
R76	0R	film resistor	R0805		
R77	680R	PTC	R0805	EPCOS	B59701A0100A062
R78	255K	film resistor	R0805		
R79	0R	film resistor	R1206		
R8	2k21	film resistor	R1206		
R80	0R	film resistor	R1206		
R81	0R	film resistor	R1206		
R82	22R	film resistor	R0805		
R83	0R68	film resistor	R1206		
R84	0R5	film resistor	R1206		
R85	20K	film resistor	R0805		
R9	100K	film resistor	R0805		
T1	EVD30	PFC inductance	EVD30	ICT	NP2014-9135
T2	transformer	llc transformer	ED26/7/30-12PIN	ICT	NP2014-9134
U1	AZ431	V-regulator	SOT-23		
U6	AZ431	V-regulator	SOT-23		
VR1	S10K350E2K1	varistor	VR-8*4*5P	EPCOS	S10K350E2K1
X1	3pin connector	connector	WAGO3P	WÜRTH	691412120003B
X2	2pin connector	connector	WAGO2P	WÜRTH	691412120002B
	heatsink-second	heatsink			
	heatsink-prim.	heatsink			

9 References

[1] ICL5101 Data Sheet

Revision History

Revision History

Major changes since the last revision

Date	Version	Changed by	Change Description
2015-02-03	1.1	KLING	Published & initial
2015-02-11	2.0	KLING	EMI Performance Conductive and Radiated / CE Certificated
2015-02-11	2.0	KLING	Section 1: Board Photo
2015-02-13	2.0	KLING	Section 2: Board Dimension Adjustment
2015-02-13	2.0	KLING	Section 3: Schematic
2015-02-13	2.0	KLING	Section 4: Complete Update
2015-02-13	2.0	KLING	Section 4.4: EMI Test (NEW)
2015-02-13	2.0	KLING	Section 5: Surge, Flicker and Burst (NEW)
2015-02-13	2.0	KLING	Section 7: Board Layout (Update)
2015-02-13	2.0	KLING	Section 8: Bill of Material BOM (Update)
2015-02-19	2.0	KLING	Improved Resolution of Figure: 2 / 29 / 30 / 31
2015-02-19	2.0	KLING	Section 4.1.2: Start-Up Time, Update of Figure 4 until Figure 9
2015-02-24	2.1	KLING	Schematic Update Figure: 2
2015-03-02	2.1	KLING	LLC Transformer Figure: 28 / Resolution
2015-03-04	2.1	KLING	Resonant Choke Figure: 27 / Resolution
2015-02-05	2.1	KLING	Schematic Update Figure: 2 / BOM Update
2015-03-04	2.1	KLING	PFC Choke Figure: 26 / Resolution
2015-04-13	2.1	KLING	Update BOM / including Supplier and Part Number
2015-06-19	2.1	KLING	Typo Correction
2015-07-24	2.1	KLING	Figure 11 update / Figure 12 new
2015-07-27	2.1	KLING	Add THD description for stable and vary load condition
2015-07-27	2.1	KLING	Add Surge protection feature
2015-09-19	2.2	KLING	BOM & Schematic correction: L8: Value / C30 + D1 Partnr.
2015-09-19	2.2	KLING	Overall correction

Trademarks of Infineon Technologies AG

AURIX™, C166™, CanPAK™, CIPOST™, CIPURSE™, CoolGaN™, CoolMOS™, CoolSET™, CoolSiC™, CORECONTROL™, CROSSAVE™, DAVE™, DI-POL™, DrBLADE™, EasyPIM™, EconoBRIDGE™, EconoDUAL™, EconoPACK™, EconoPIM™, EiceDRIVER™, eupec™, FCOS™, HITFET™, HybridPACK™, ISOFACE™, IsoPACK™, i-Wafer™, MIPAQ™, ModSTACK™, my-d™, NovalithIC™, OmniTune™, OPTIGA™, OptiMOS™, ORIGA™, POWERCODE™, PRIMARION™, PrimePACK™, PrimeSTACK™, PROFET™, PRO-SIL™, RASIC™, REAL3™, ReverSave™, SatRIC™, SIEGET™, SIPMOS™, SmartLEWIS™, SOLID FLASH™, SPOC™, TEMPFET™, thinQ™, TRENCHSTOP™, TriCore™.

Other Trademarks

Advance Design System™ (ADS) of Agilent Technologies, AMBA™, ARM™, MULTI-ICE™, KEIL™, PRIMECELL™, REALVIEW™, THUMB™, μVision™ of ARM Limited, UK. ANSI™ of American National Standards Institute. AUTOSAR™ of AUTOSAR development partnership. Bluetooth™ of Bluetooth SIG Inc. CAT-iq™ of DECT Forum. COLOSSUS™, FirstGPS™ of Trimble Navigation Ltd. EMV™ of EMVCo, LLC (Visa Holdings Inc.). EPCOS™ of Epcos AG. FLEXGO™ of Microsoft Corporation. HYPERTERMINAL™ of Hilgraeve Incorporated. MCS™ of Intel Corp. IEC™ of Commission Electrotechnique Internationale. IrDA™ of Infrared Data Association Corporation. ISO™ of INTERNATIONAL ORGANIZATION FOR STANDARDIZATION. MATLAB™ of MathWorks, Inc. MAXIM™ of Maxim Integrated Products, Inc. MICROTEC™, NUCLEUS™ of Mentor Graphics Corporation. MIPI™ of MIPI Alliance, Inc. MIPS™ of MIPS Technologies, Inc., USA. muRata™ of MURATA MANUFACTURING CO., MICROWAVE OFFICE™ (MWO) of Applied Wave Research Inc., OmniVision™ of OmniVision Technologies, Inc. Openwave™ of Openwave Systems Inc. RED HAT™ of Red Hat, Inc. RFMD™ of RF Micro Devices, Inc. SIRIUS™ of Sirius Satellite Radio Inc. SOLARIS™ of Sun Microsystems, Inc. SPANSION™ of Spansion LLC Ltd. Symbian™ of Symbian Software Limited. TAIYO YUDEN™ of Taiyo Yuden Co. TEAKLITE™ of CEVA, Inc. TEKTRONIX™ of Tektronix Inc. TOKO™ of TOKO KABUSHIKI KAISHA TA. UNIX™ of X/Open Company Limited. VERILOG™, PALLADIUM™ of Cadence Design Systems, Inc. VLYNQ™ of Texas Instruments Incorporated. VXWORKS™, WIND RIVER™ of WIND RIVER SYSTEMS, INC. ZETEX™ of Diodes Zetex Limited.

Last Trademarks Update 2014-07-17

www.infineon.com

Edition 2015-09-22

Published by

Infineon Technologies AG

81726 Munich, Germany

© 2016 Infineon Technologies AG.

All Rights Reserved.

Do you have a question about any aspect of this document?

Email: erratum@infineon.com

Document reference

ANDEMO_201501_PL21_010

Legal Disclaimer

THE INFORMATION GIVEN IN THIS APPLICATION NOTE (INCLUDING BUT NOT LIMITED TO CONTENTS OF REFERENCED WEBSITES) IS GIVEN AS A HINT FOR THE IMPLEMENTATION OF THE INFINEON TECHNOLOGIES COMPONENT ONLY AND SHALL NOT BE REGARDED AS ANY DESCRIPTION OR WARRANTY OF A CERTAIN FUNCTIONALITY, CONDITION OR QUALITY OF THE INFINEON TECHNOLOGIES COMPONENT. THE RECIPIENT OF THIS APPLICATION NOTE MUST VERIFY ANY FUNCTION DESCRIBED HEREIN IN THE REAL APPLICATION. INFINEON TECHNOLOGIES HEREBY DISCLAIMS ANY AND ALL WARRANTIES AND LIABILITIES OF ANY KIND (INCLUDING WITHOUT LIMITATION WARRANTIES OF NON-INFRINGEMENT OF INTELLECTUAL PROPERTY RIGHTS OF ANY THIRD PARTY) WITH RESPECT TO ANY AND ALL INFORMATION GIVEN IN THIS APPLICATION NOTE.

Information

For further information on technology, delivery terms and conditions and prices, please contact the nearest Infineon Technologies Office (www.infineon.com).

Warnings

Due to technical requirements, components may contain dangerous substances. For information on the types in question, please contact the nearest Infineon Technologies Office. Infineon Technologies components may be used in life-support devices or systems only with the express written approval of Infineon Technologies, if a failure of such components can reasonably be expected to cause the failure of that life-support device or system or to affect the safety or effectiveness of that device or system. Life support devices or systems are intended to be implanted in the human body or to support and/or maintain and sustain and/or protect human life. If they fail, it is reasonable to assume that the health of the user or other persons may be endangered.



Компания «ЭлектроПласт» предлагает заключение долгосрочных отношений при поставках импортных электронных компонентов на взаимовыгодных условиях!

Наши преимущества:

- Оперативные поставки широкого спектра электронных компонентов отечественного и импортного производства напрямую от производителей и с крупнейших мировых складов;
- Поставка более 17-ти миллионов наименований электронных компонентов;
- Поставка сложных, дефицитных, либо снятых с производства позиций;
- Оперативные сроки поставки под заказ (от 5 рабочих дней);
- Экспресс доставка в любую точку России;
- Техническая поддержка проекта, помощь в подборе аналогов, поставка прототипов;
- Система менеджмента качества сертифицирована по Международному стандарту ISO 9001;
- Лицензия ФСБ на осуществление работ с использованием сведений, составляющих государственную тайну;
- Поставка специализированных компонентов (Xilinx, Altera, Analog Devices, Intersil, Interpoint, Microsemi, Aeroflex, Peregrine, Syfer, Eurofarad, Texas Instrument, Miteq, Cobham, E2V, MA-COM, Hittite, Mini-Circuits, General Dynamics и др.);

Помимо этого, одним из направлений компании «ЭлектроПласт» является направление «Источники питания». Мы предлагаем Вам помощь Конструкторского отдела:

- Подбор оптимального решения, техническое обоснование при выборе компонента;
- Подбор аналогов;
- Консультации по применению компонента;
- Поставка образцов и прототипов;
- Техническая поддержка проекта;
- Защита от снятия компонента с производства.



Как с нами связаться

Телефон: 8 (812) 309 58 32 (многоканальный)

Факс: 8 (812) 320-02-42

Электронная почта: org@eplast1.ru

Адрес: 198099, г. Санкт-Петербург, ул. Калинина, дом 2, корпус 4, литера А.