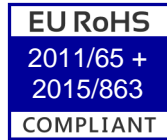

# EHF1120TS-46.320M

[Click part number to visit Part Number Details page](#)

## REGULATORY COMPLIANCE (Data Sheet downloaded on Jun 9, 2016)

[Click badges to download compliance docs](#)

Regulatory Compliance standards are subject to updates by governing bodies. Click the badges to download the latest compliance docs for this part number directly from Ecliptek.



## ITEM DESCRIPTION

Quartz Crystal Clock Oscillators XO (SPXO) HCMOS/TTL (CMOS) 5.0Vdc 14 Pin DIP Metal Thru-Hole 46.320MHz  $\pm 20$ ppm 0°C to +70°C

## ELECTRICAL SPECIFICATIONS

Nominal Frequency	46.320MHz
Frequency Tolerance/Stability	$\pm 20$ ppm Maximum (Inclusive of all conditions: Calibration Tolerance at 25°C, Frequency Stability over the Operation Temperature Range, Supply Voltage Change, Output Load Change, First Year Aging at 25°C, Shock, and Vibration.)
Aging at 25°C	$\pm 5$ ppm/year Maximum
Operating Temperature Range	0°C to +70°C
Supply Voltage	5.0Vdc $\pm 10\%$
Input Current	50mA Maximum (No Load)
Output Voltage Logic High (Voh)	2.4Vdc Minimum with TTL Load, Vdd-0.4Vdc Minimum with HCMOS Load (IOH = -16mA)
Output Voltage Logic Low (Vol)	0.4Vdc Maximum with TTL Load, 0.5Vdc Maximum with HCMOS Load (IOL = +16mA)
Rise/Fall Time	6nSec Maximum (Measured at 0.8Vdc to 2.0Vdc with TTL Load, Measured at 20% to 80% of waveform with HCMOS Load)
Duty Cycle	50 $\pm 10$ (%) (Measured at 1.4Vdc with TTL Load or at 50% of waveform with HCMOS Load)
Load Drive Capability	10TTL Load or 50pF HCMOS Load Maximum
Output Logic Type	CMOS
Pin 1 Connection	Tri-State (Disabled Output: High Impedance)
Tri-State Input Voltage (Vih and Vil)	+2.2Vdc Minimum to enable output, +0.8Vdc Maximum to disable output (High Impedance), No Connect to enable output.
Absolute Clock Jitter	$\pm 250$ pSec Maximum, $\pm 100$ pSec Typical
One Sigma Clock Period Jitter	$\pm 50$ pSec Maximum, $\pm 30$ pSec Typical
Start Up Time	10mSec Maximum
Storage Temperature Range	-55°C to +125°C

## ENVIRONMENTAL & MECHANICAL SPECIFICATIONS

Fine Leak Test	MIL-STD-883, Method 1014, Condition A
Gross Leak Test	MIL-STD-883, Method 1014, Condition C
Lead Integrity	MIL-STD-883, Method 2004
Mechanical Shock	MIL-STD-202, Method 213, Condition C
Resistance to Soldering Heat	MIL-STD-202, Method 210
Resistance to Solvents	MIL-STD-202, Method 215
Solderability	MIL-STD-883, Method 2003
Temperature Cycling	MIL-STD-883, Method 1010
Vibration	MIL-STD-883, Method 2007, Condition A

# EHF1120TS-46.320M

[Click part number to visit Part Number Details page](#)

## MECHANICAL DIMENSIONS (all dimensions in millimeters)

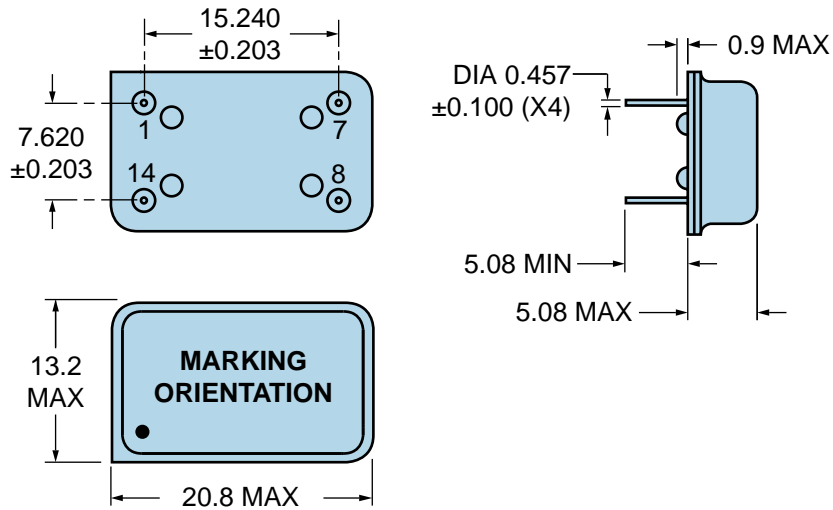

PIN	CONNECTION
1	Tri-State (High Impedance)
7	Ground/Case Ground
8	Output
14	Supply Voltage

LINE	MARKING
1	<b>ECLIPTEK</b>
2	<b>46.320M</b>
3	<b>XXXXX</b> XXXXX=Ecliptek Manufacturing Identifier

# EHF1120TS-46.320M

[Click part number to visit Part Number Details page](#)

## OUTPUT WAVEFORM & TIMING DIAGRAM

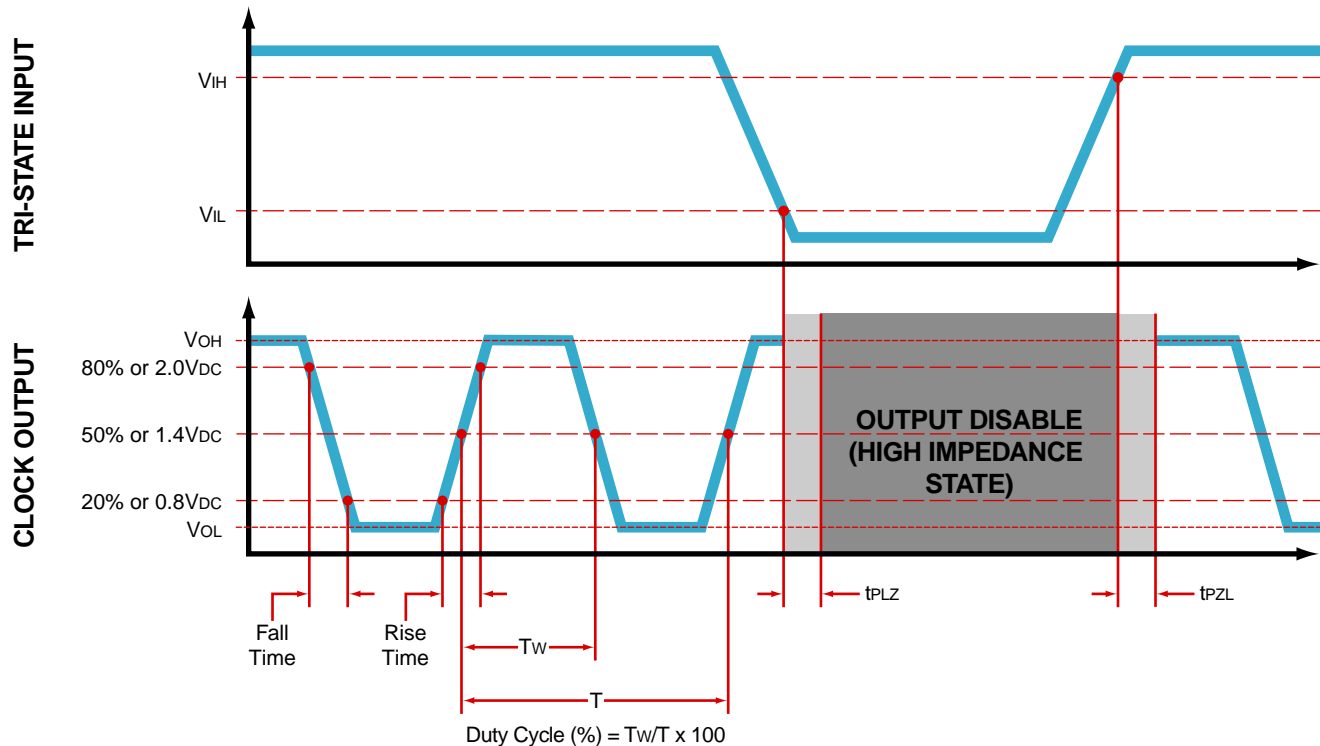

**Test Circuit for CMOS Output**

Note 1: An external  $0.01\mu\text{F}$  ceramic bypass capacitor in parallel with a  $0.1\mu\text{F}$  high frequency ceramic bypass capacitor close (less than 2mm) to the package ground and supply voltage pin is required.

Note 2: A low capacitance ( $<12\text{pF}$ ), 10X attenuation factor, high impedance ( $>10\text{Mohms}$ ), and high bandwidth ( $>300\text{MHz}$ ) passive probe is recommended.

Note 3: Capacitance value  $C_L$  includes sum of all probe and fixture capacitance.

## Test Circuit for TTL Output

Output Load Drive Capability	$R_L$ Value (Ohms)	$C_L$ Value (pF)
10TTL	390	15
5TTL	780	15

Table 1:  $R_L$  Resistance Value and  $C_L$  Capacitance Value Vs. Output Load Drive Capability

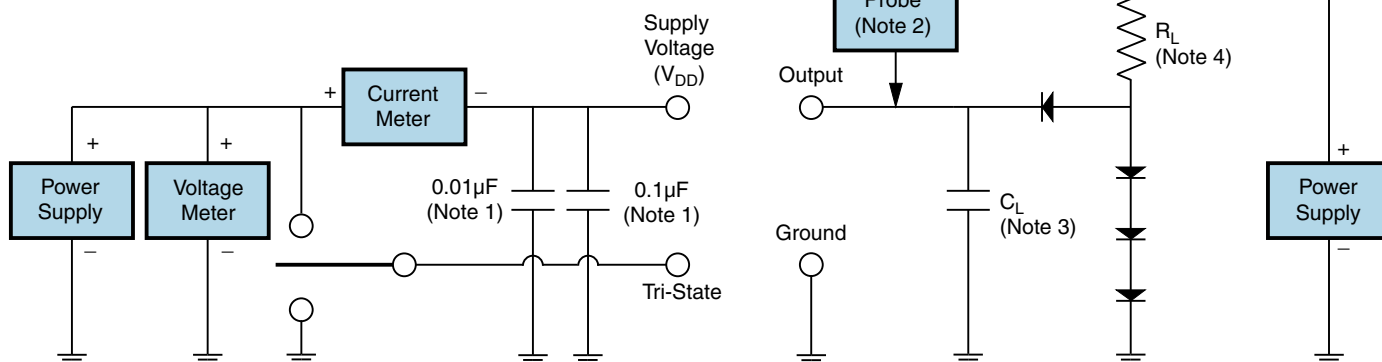

Note 1: An external 0.01µF ceramic bypass capacitor in parallel with a 0.1µF high frequency ceramic bypass capacitor close (less than 2mm) to the package ground and supply voltage pin is required.

Note 2: A low capacitance (<12pF), 10X attenuation factor, high impedance (>10Mohms), and high bandwidth (>300MHz) passive probe is recommended.

Note 3: Capacitance value  $C_L$  includes sum of all probe and fixture capacitance.

Note 4: Resistance value  $R_L$  is shown in Table 1. See applicable specification sheet for 'Load Drive Capability'.

Note 5: All diodes are MMBD7000, MMBD914, or equivalent.

# EHF1120TS-46.320M

[Click part number to visit Part Number Details page](#)

## Recommended Solder Reflow Methods

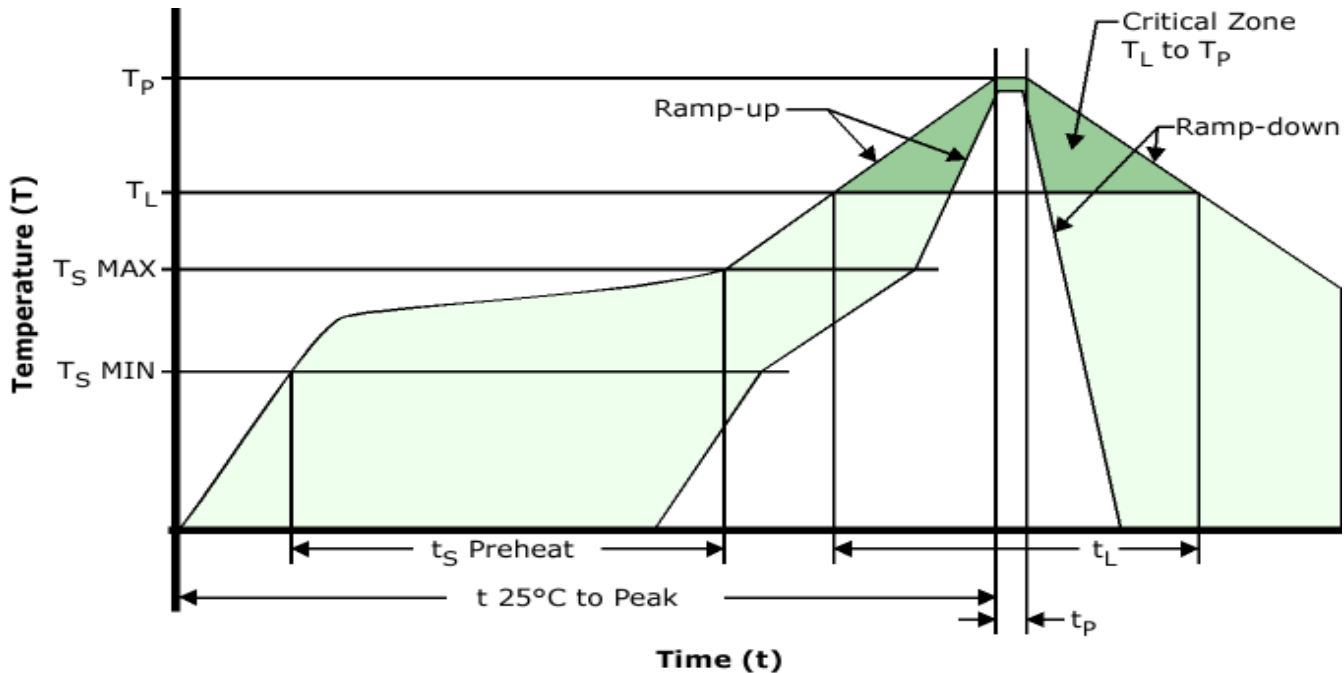

### High Temperature Solder Bath (Wave Solder)

$T_S$ MAX to $T_L$ (Ramp-up Rate)	3°C/Second Maximum
<b>Preheat</b>	
- Temperature Minimum ( $T_S$ MIN)	150°C
- Temperature Typical ( $T_S$ TYP)	175°C
- Temperature Maximum ( $T_S$ MAX)	200°C
- Time ( $t_s$ MIN)	60 - 180 Seconds
<b>Ramp-up Rate (<math>T_L</math> to <math>T_P</math>)</b>	3°C/Second Maximum
<b>Time Maintained Above:</b>	
- Temperature ( $T_L$ )	217°C
- Time ( $t_L$ )	60 - 150 Seconds
<b>Peak Temperature (<math>T_P</math>)</b>	260°C Maximum for 10 Seconds Maximum
<b>Target Peak Temperature (<math>T_P</math> Target)</b>	250°C +0/-5°C
<b>Time within 5°C of actual peak (<math>t_p</math>)</b>	20 - 40 Seconds
<b>Ramp-down Rate</b>	6°C/Second Maximum
<b>Time 25°C to Peak Temperature (t)</b>	8 Minutes Maximum
<b>Moisture Sensitivity Level</b>	Level 1
<b>Additional Notes</b>	Temperatures shown are applied to back of PCB board and device leads only. Do not use this method for product with the Gull Wing option.

# EHF1120TS-46.320M

[Click part number to visit Part Number Details page](#)

## Recommended Solder Reflow Methods

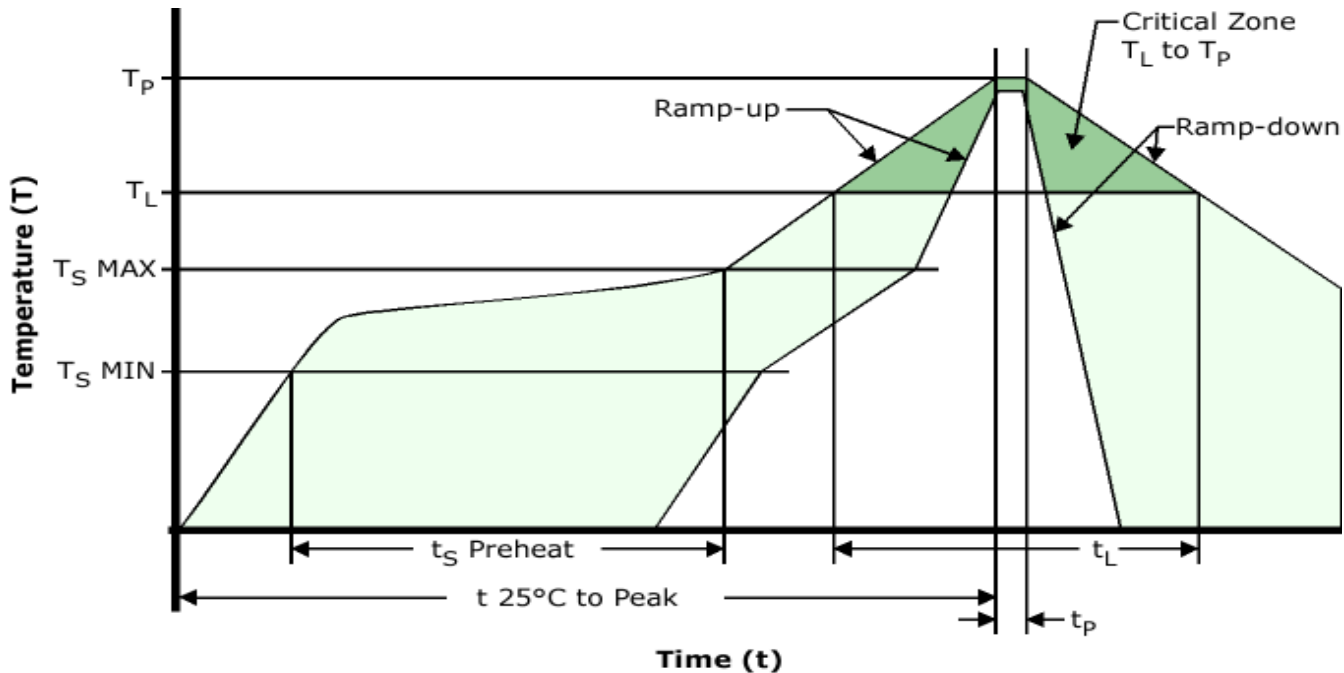

### Low Temperature Infrared/Convection 185°C

$T_S$ MAX to $T_L$ (Ramp-up Rate)	5°C/Second Maximum
<b>Preheat</b>	
- Temperature Minimum ( $T_S$ MIN)	N/A
- Temperature Typical ( $T_S$ TYP)	150°C
- Temperature Maximum ( $T_S$ MAX)	N/A
- Time ( $t_s$ MIN)	60 - 120 Seconds
<b>Ramp-up Rate (<math>T_L</math> to <math>T_P</math>)</b>	5°C/Second Maximum
<b>Time Maintained Above:</b>	
- Temperature ( $T_L$ )	150°C
- Time ( $t_L$ )	200 Seconds Maximum
<b>Peak Temperature (<math>T_P</math>)</b>	185°C Maximum
<b>Target Peak Temperature (<math>T_P</math> Target)</b>	185°C Maximum 2 Times
<b>Time within 5°C of actual peak (<math>t_p</math>)</b>	10 Seconds Maximum 2 Times
<b>Ramp-down Rate</b>	5°C/Second Maximum
<b>Time 25°C to Peak Temperature (t)</b>	N/A
<b>Moisture Sensitivity Level</b>	Level 1
<b>Additional Notes</b>	Temperatures shown are applied to body of device. Use this method only for product with the Gull Wing option.

# EHF1120TS-46.320M

[Click part number to visit Part Number Details page](#)

## Recommended Solder Reflow Methods

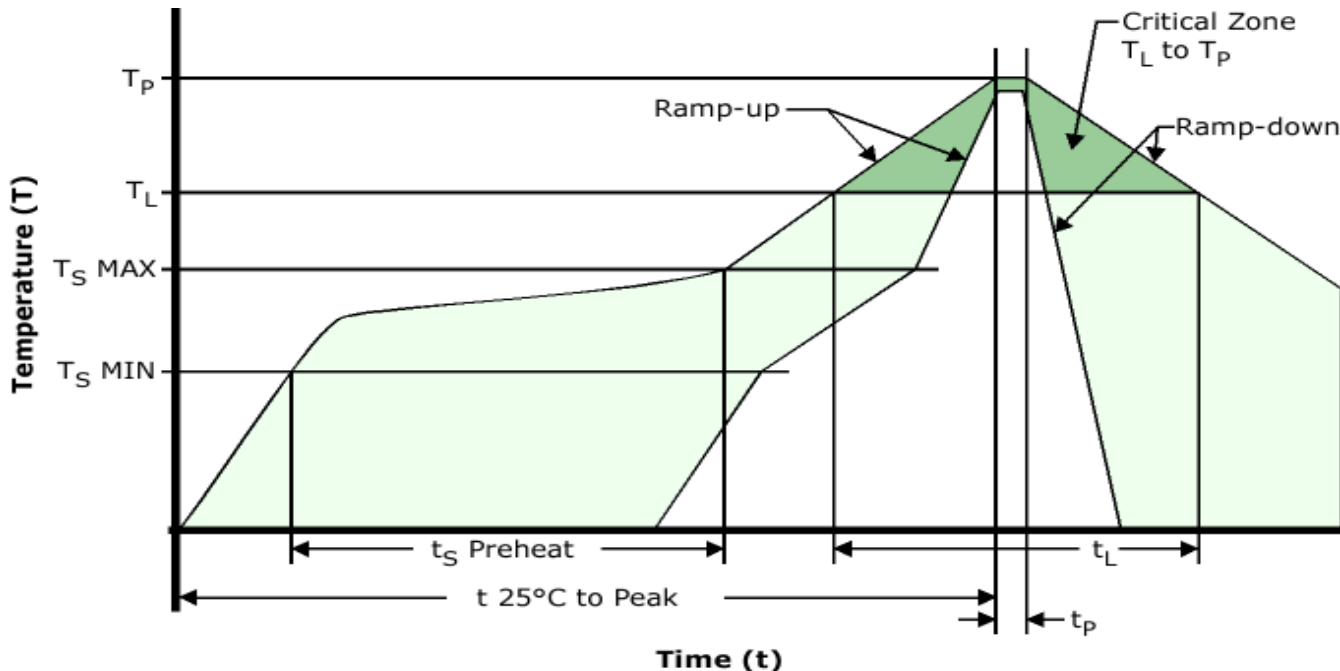

### Low Temperature Solder Bath (Wave Solder)

Ts MAX to TL (Ramp-up Rate)	5°C/Second Maximum
-----------------------------	--------------------

#### Preheat

- Temperature Minimum (Ts MIN)	N/A
- Temperature Typical (Ts TYP)	150°C
- Temperature Maximum (Ts MAX)	N/A
- Time (ts MIN)	30 - 60 Seconds

Ramp-up Rate (TL to TP)	5°C/Second Maximum
-------------------------	--------------------

#### Time Maintained Above:

- Temperature (TL)	150°C
- Time (tL)	200 Seconds Maximum

Peak Temperature (TP)	245°C Maximum
-----------------------	---------------

Target Peak Temperature (TP Target)	245°C Maximum 1 Time / 235°C Maximum 2 Times
-------------------------------------	----------------------------------------------

Time within 5°C of actual peak (tp)	5 Seconds Maximum 1 Time / 15 Seconds Maximum 2 Times
-------------------------------------	-------------------------------------------------------

Ramp-down Rate	5°C/Second Maximum
----------------	--------------------

Time 25°C to Peak Temperature (t)	N/A
-----------------------------------	-----

Moisture Sensitivity Level	Level 1
----------------------------	---------

#### Additional Notes

Temperatures shown are applied to back of PCB board and device leads only. Do not use this method for product with the Gull Wing option.

### Low Temperature Manual Soldering

185°C Maximum for 10 Seconds Maximum, 2 times Maximum. (Temperatures listed are applied to device leads only. This method can be utilized with both Gull Wing and Non-Gull Wing devices.)

### High Temperature Manual Soldering

260°C Maximum for 5 Seconds Maximum, 2 times Maximum. (Temperatures listed are applied to device leads only. This method can be utilized with both Gull Wing and Non-Gull Wing devices.)



# Mouser Electronics

Authorized Distributor

Click to View Pricing, Inventory, Delivery & Lifecycle Information:

[Ecliptek:](#)

[EHF1120TS-46.320M](#)



Компания «ЭлектроПласт» предлагает заключение долгосрочных отношений при поставках импортных электронных компонентов на взаимовыгодных условиях!

Наши преимущества:

- Оперативные поставки широкого спектра электронных компонентов отечественного и импортного производства напрямую от производителей и с крупнейших мировых складов;
- Поставка более 17-ти миллионов наименований электронных компонентов;
- Поставка сложных, дефицитных, либо снятых с производства позиций;
- Оперативные сроки поставки под заказ (от 5 рабочих дней);
- Экспресс доставка в любую точку России;
- Техническая поддержка проекта, помощь в подборе аналогов, поставка прототипов;
- Система менеджмента качества сертифицирована по Международному стандарту ISO 9001;
- Лицензия ФСБ на осуществление работ с использованием сведений, составляющих государственную тайну;
- Поставка специализированных компонентов (Xilinx, Altera, Analog Devices, Intersil, Interpoint, Microsemi, Aeroflex, Peregrine, Syfer, Eurofarad, Texas Instrument, Miteq, Cobham, E2V, MA-COM, Hittite, Mini-Circuits, General Dynamics и др.);

Помимо этого, одним из направлений компании «ЭлектроПласт» является направление «Источники питания». Мы предлагаем Вам помощь Конструкторского отдела:

- Подбор оптимального решения, техническое обоснование при выборе компонента;
- Подбор аналогов;
- Консультации по применению компонента;
- Поставка образцов и прототипов;
- Техническая поддержка проекта;
- Защита от снятия компонента с производства.



#### Как с нами связаться

**Телефон:** 8 (812) 309 58 32 (многоканальный)

**Факс:** 8 (812) 320-02-42

**Электронная почта:** [org@eplast1.ru](mailto:org@eplast1.ru)

**Адрес:** 198099, г. Санкт-Петербург, ул. Калинина, дом 2, корпус 4, литера А.