150mA 10V INPUT LDO REGULATOR

NO.EA-245-180427

OUTLINE

The RP171x is LDO regulator featuring 150mA output current. Because of the 10V maximum input voltage, RP171x can be used in 2 cell lithium-ion battery powered portable appliances and besides a portable equipment. The supply current is Typ. 23 μ A though an excellent response characteristics.

The output voltage range from 1.2V is possible. The output voltage accuracy and temperature-drift coefficient of output voltage of the RP171x Series are excellent.

RP171x has a fold-back protection circuit and a thermal shutdown circuit. Moreover, a standby mode with ultra-low supply current can be realized with the chip enable function.

SC-88A and SOT-23-5 with high power dissipation packages are available.

FEATURES

- Supply Current Typ. 23 μ A
- Standby Mode Typ. 0.1 μ A
- Dropout Voltage Typ. 0.20V ($I_{OUT}=100mA$, $V_{OUT}=3.0V$)
Typ. 0.40V ($I_{OUT}=150mA$, $V_{OUT}=2.8V$)
- Ripple Rejection Typ. 70dB ($f=1kHz$)
- Temperature-Drift Coefficient of Output Voltage Typ. $\pm 80ppm/^{\circ}C$
- Line Regulation Typ. 0.02%/V
- Output Voltage Accuracy $\pm 1.0\%$
- Packages SC-88A, SOT-23-5
- Input Voltage Range 2.6V to 10.0V
- Output Voltage Range 1.2V to 6.0V (0.1V steps)
(For other voltages, please refer to
MARK INFORMATIONS.)
- Built-in Fold Back Protection Circuit Typ. 40mA (Current at short mode)
- Built-in Thermal Shutdown Circuit Shutdown Temperature at 165 $^{\circ}C$
- Built-in Constant Slope Circuit (Soft-start Function)
- Ceramic capacitors are recommended to be used with this IC 1.0 μ F or more

APPLICATIONS

- Power source for portable communication equipment.
- Power source for electrical appliances such as cameras, VCRs and camcorders.
- Power source for battery-powered equipment.
- Power source for home appliances.

RP171x

NO.EA-245-180427

SELECTION GUIDE

The output voltage, auto-discharge⁽¹⁾ function, and package, etc. for the ICs can be selected at the user's request.

Product Name	Package	Quantity per Reel	Pb Free	Halogen Free
RP171Qxx2*-TR-FE	SC-88A	3,000 pcs	Yes	Yes
RP171Nxx1*-TR-FE	SOT-23-5	3,000 pcs	Yes	Yes

xx: The output voltage can be designated in the range from 1.2V(12) to 6.0V(60) in 0.1V steps.
(For other voltages, please refer to MARK INFORMATIONS.)

- * : The auto discharge function at off state are options as follows.
(B) without auto discharge function at off state
(D) with auto discharge function at off state

BLOCK DIAGRAMS

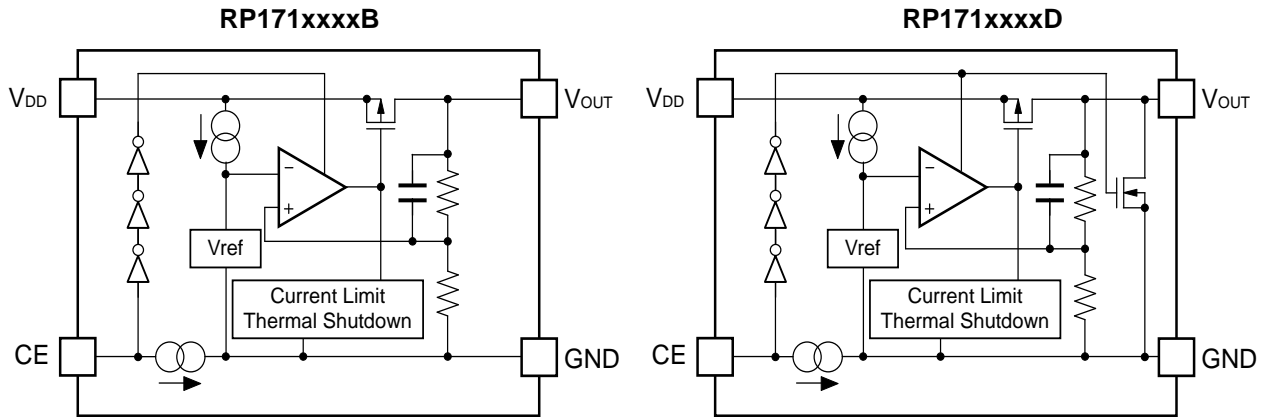

⁽¹⁾ Auto-discharge function quickly lowers the output voltage to 0V by releasing the electrical charge accumulated in the external capacitor when the chip enable signal is switched from the active mode to the standby mode.

PIN CONFIGURATIONS

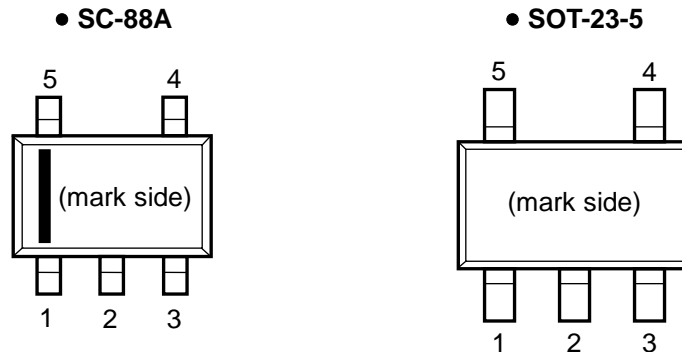

PIN DESCRIPTIONS

• SC-88A

Pin No.	Symbol	Pin Description
1	CE	Chip Enable Pin ("H" Active)
2 *	NC	No Connection
3	GND	Ground Pin
4	VOUT	Output Pin
5	VDD	Input Pin

* Pin No. 2 is connected to the bottom of the IC. It is recommended that the pin be connected to the ground plane on the board, or otherwise be left floating so that there is no contact with other potentials.

• SOT-23-5

Pin No	Symbol	Pin Description
1	VDD	Input Pin
2	GND	Ground Pin
3	CE	Chip Enable Pin ("H" Active)
4	NC	No Connection
5	VOUT	Output Pin

RP171x

NO.EA-245-180427

ABSOLUTE MAXIMUM RATINGS

Symbol	Item		Rating	Unit
V_{IN}	Input Voltage		12	V
V_{CE}	Input Voltage (CE Pin)		12	V
V_{OUT}	Output Voltage		-0.3 to $V_{IN}+0.3$	V
I_{OUT}	Output Current		330	mA
P_D	Power Dissipation ⁽¹⁾	SC-88A (Standard Test Land Pattern)	380	mW
		SOT-23-5 (JEDEC STD. 51-7)	660	
T_j	Junction Temperature Range		-40 to 125	°C
T_{stg}	Storage Temperature Range		-55 to 125	°C

ABSOLUTE MAXIMUM RATINGS

Electronic and mechanical stress momentarily exceeded absolute maximum ratings may cause the permanent damages and may degrade the life time and safety for both device and system using the device in the field. The functional operation at or over these absolute maximum ratings is not assured.

RECCOMENDED OPERATING CONDITIONS

Symbol	Parameter	Rating	Unit
V_{IN}	Input Voltage	2.6 to 10	V
T_a	Operating Temperature Range	-40 to 85	°C

RECOMMENDED OPERATING CONDITIONS

All of electronic equipment should be designed that the mounted semiconductor devices operate within the recommended operating conditions. The semiconductor devices cannot operate normally over the recommended operating conditions, even if when they are used over such ratings by momentary electronic noise or surge. And the semiconductor devices may receive serious damage when they continue to operate over the recommended operating conditions.

⁽¹⁾Refer to POWER DISSIPATION for detailed information

ELECTRICAL CHARACTERISTICS

V_{IN} =Set $V_{OUT}+1V$, $I_{OUT}=1mA$, unless otherwise noted.

The specifications in are guaranteed by Design Engineering at $-40^{\circ}C \leq T_a \leq 85^{\circ}C$.

RP171xxxxB/D

($T_a = 25^{\circ}C$)

Symbol	Item	Conditions	Min.	Typ.	Max.	Unit		
V_{OUT}	Output Voltage	$T_a=25^{\circ}C$	$V_{OUT} > 1.5V$	$\times 0.99$		$\times 1.01$	V	
			$V_{OUT} \leq 1.5V$	-15		+15	mV	
		$-40^{\circ}C \leq T_a \leq 85^{\circ}C$	$V_{OUT} > 1.5V$	$\times 0.974$		$\times 1.023$		V
			$V_{OUT} \leq 1.5V$	-40		+35		mV
I_{OUT}	Output Current		150			mA		
$\Delta V_{OUT}/\Delta I_{OUT}$	Load Regulation	$0.1mA \leq I_{OUT} \leq 150mA$		5	40	mV		
V_{DIF}	Dropout Voltage	$I_{OUT}=150mA$	$1.2V \leq V_{OUT} < 1.3V$		-	1.400	V	
			$1.3V \leq V_{OUT} < 1.5V$		-	1.300		
			$1.5V \leq V_{OUT} < 1.8V$		-	1.100		
			$1.8V \leq V_{OUT} < 2.3V$		-	0.800		
			$2.3V \leq V_{OUT} < 3.0V$		0.400	0.580		
			$3.0V \leq V_{OUT} < 4.0V$		0.300	0.480		
			$4.0V \leq V_{OUT} \leq 6.0V$		0.250	0.400		
I_{SS}	Supply Current	$I_{OUT}=0mA$		23	40	μA		
$I_{standby}$	Standby Current	$V_{IN}=10.0V, V_{CE}=GND$		0.1	1.0	μA		
$\Delta V_{OUT}/\Delta V_{IN}$	Line Regulation	Set $V_{OUT}+0.5V \leq V_{IN} \leq 10.0V$ (In case that $V_{OUT} \leq 2.1V$, $2.6V \leq V_{IN} \leq 10.0V$)		± 0.02	± 0.2	%/V		
RR	Ripple Rejection	$f=1kHz$, Ripple 0.2Vp-p, $I_{OUT}=30mA$ (In case that $V_{OUT} < 2.0V, V_{IN}=3.0V$)		70		dB		
I_{SC}	Short Current Limit	$V_{OUT}=0V$		40		mA		
I_{PD}	CE Pull-down Current			0.30		μA		
V_{CEH}	CE Input Voltage "H"		1.7			V		
V_{CEL}	CE Input Voltage "L"				0.8	V		
T_{TSD}	Thermal Shutdown Temperature	Junction Temperature		165		$^{\circ}C$		
T_{TSR}	Thermal Shutdown Released Temperature	Junction Temperature		110		$^{\circ}C$		
en	Output Noise	$BW=10Hz$ to $100kHz$		100		μV_{rms}		
R_{LOW}	Low Output Nch Tr. ON Resistance (of D version)	$V_{IN}=7.0V$ $V_{CE}=0V$		250		Ω		

All of unit are tested and specified under load conditions such that $T_j \approx T_a = 25^{\circ}C$ except for Output Noise, Ripple Rejection and Thermal Shutdown.

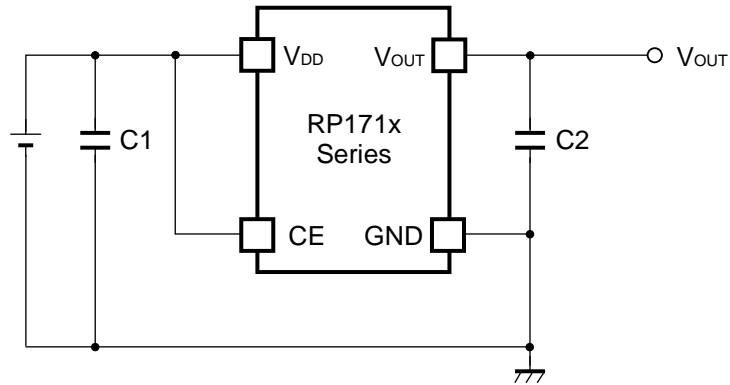
APPLICATION INFORMATION**TYPICAL APPLICATION**

(External Components)

C2 1.0 μ F MURATA: GRM155B31A105KE15

Phase Compensation

In these ICs, phase compensation is made for securing stable operation even if the load current is varied. For this purpose, use a capacitor C2 with 1.0 μ F or more and good ESR (Equivalent Series Resistance).

(Note: If additional ceramic capacitors are connected with parallel to the output pin with an output capacitor for phase compensation, the operation might be unstable. Because of this, test these ICs with as same external components as ones to be used on the PCB.)

PCB Layout

Make V_{DD} and GND lines sufficient. If their impedance is high, noise pickup or unstable operation may result. Connect a capacitor C1 with a capacitance value as much as 1.0 μ F or more between V_{DD} and GND pin, and as close as possible to the pins.

Set external components, especially the output capacitor C2, as close as possible to the ICs, and make wiring as short as possible.

ESR vs. Output Current

When using these ICs, consider the following points:

The relations between I_{OUT} (Output Current) and ESR of an output capacitor are shown below.
 The conditions when the white noise level is under $40\mu V$ (Avg.) are marked as the hatched area in the graph.

Measurement conditions

Frequency Band : 10Hz to 2MHz

Temperature : $-40^{\circ}C$ to $85^{\circ}C$

C1, C2 : Ceramic $1.0\mu F$ (Murata GRM155B31A105KE)

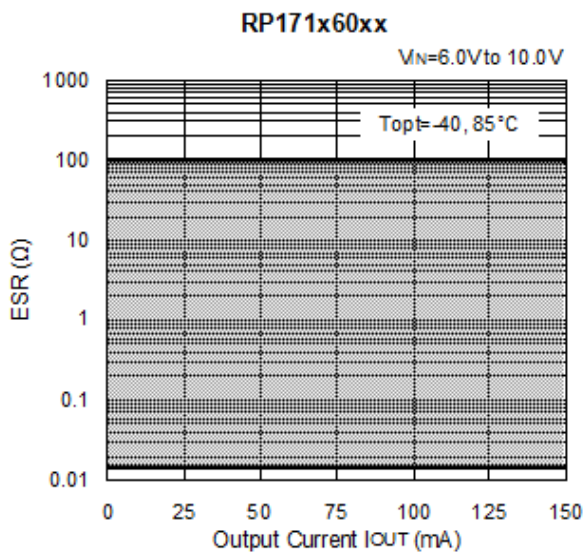
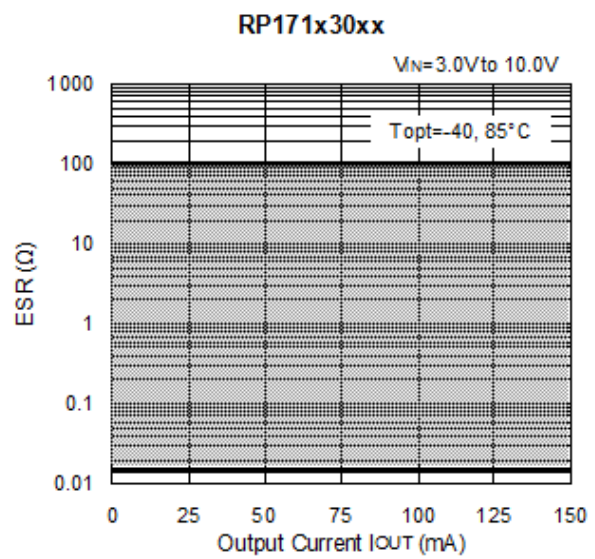
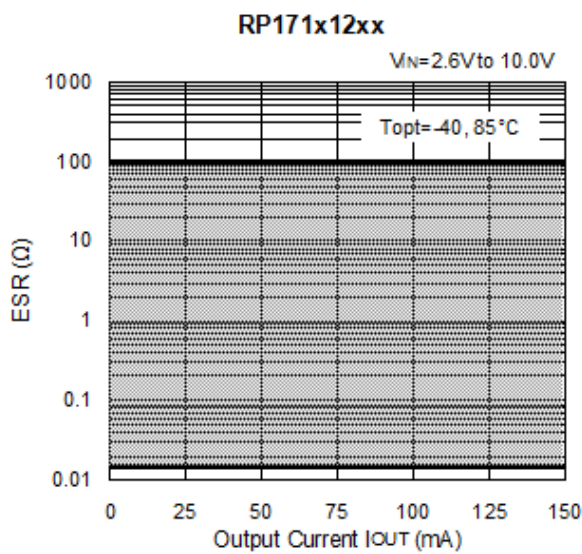

RP171x

NO.EA-245-180427

TYPICAL CHARACTERISTICS

Note: Typical Characteristics are intended to be used as reference data; they are not guaranteed.

1) Output Voltage vs. Output Current (Ta = 25°C)

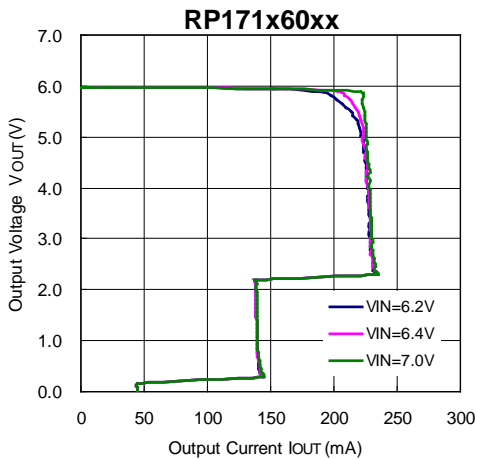
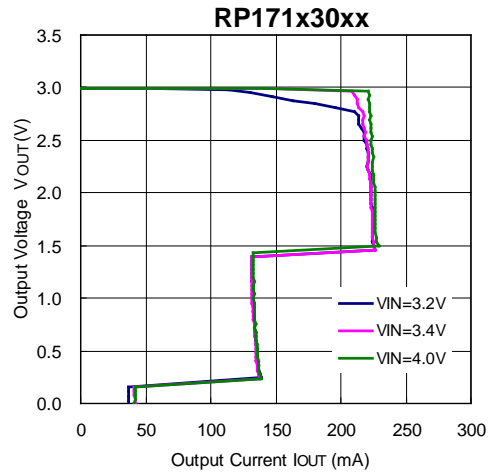
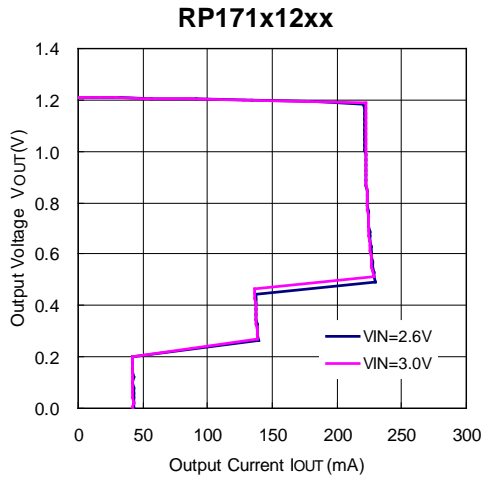

2) Output Voltage vs. Input Voltage (Ta = 25°C)

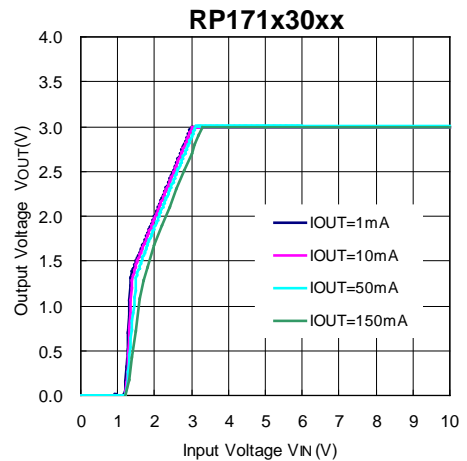
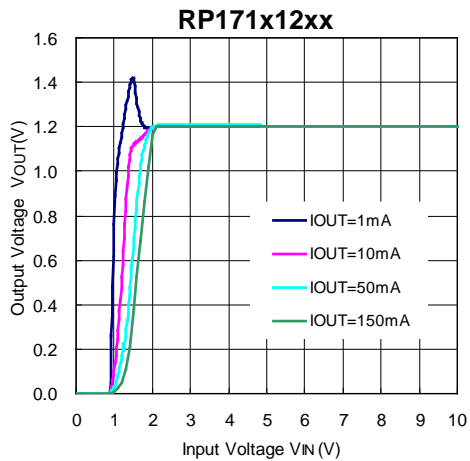

RP171x60xx

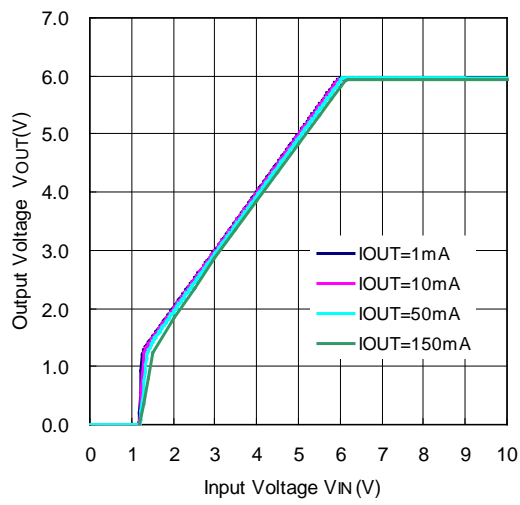

3) Supply Current vs. Input Voltage (Ta = 25°C)

RP171x12xx

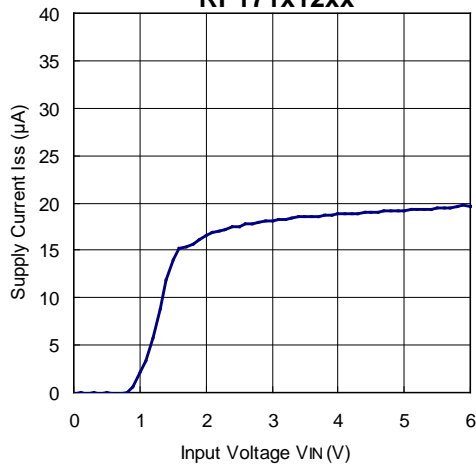

RP171x30xx

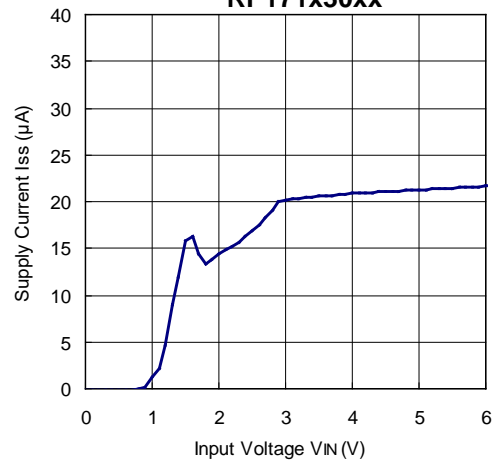

RP171x60xx

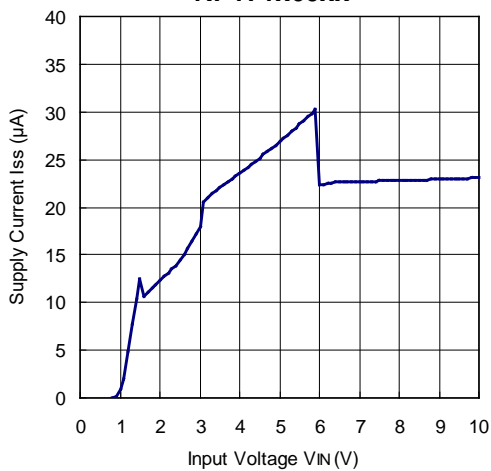

RP171x

NO.EA-245-180427

4) Supply Current vs. Output Current (Ta = 25°C)

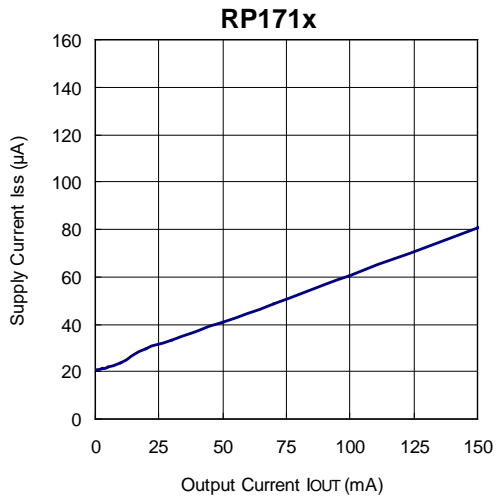

5) Output Voltage vs. Temperature

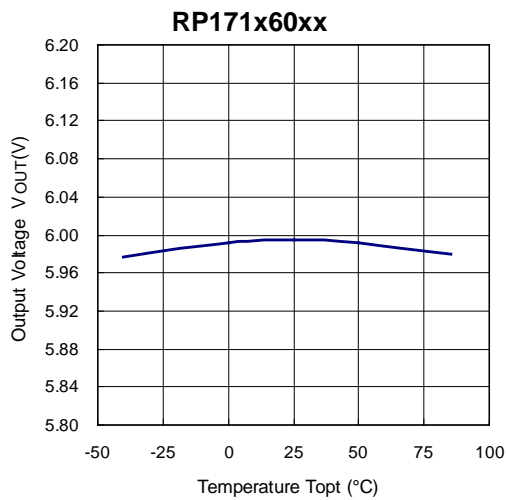
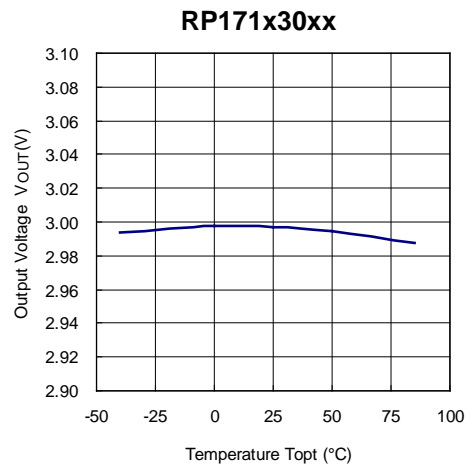
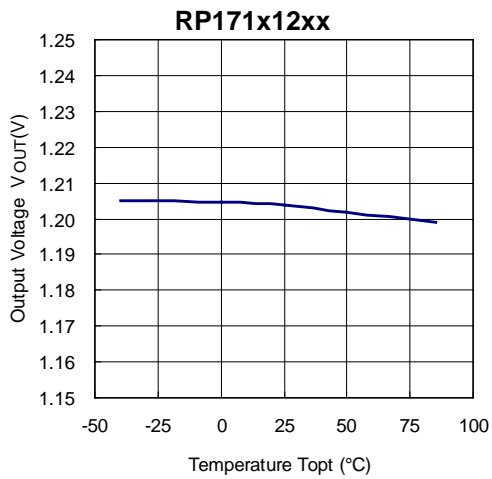

6) Supply Current vs. Temperature

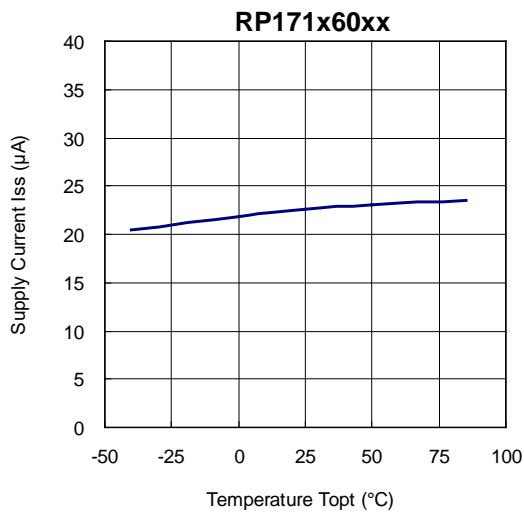
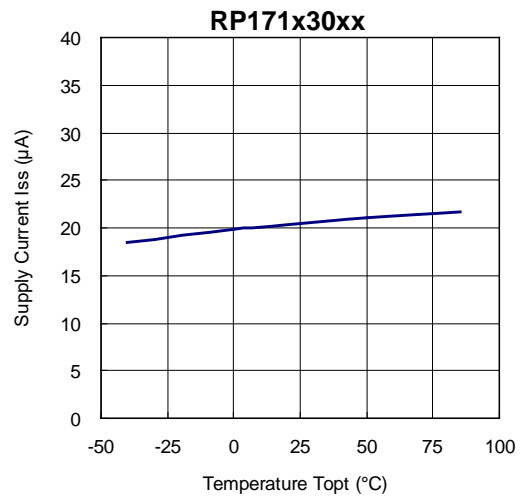
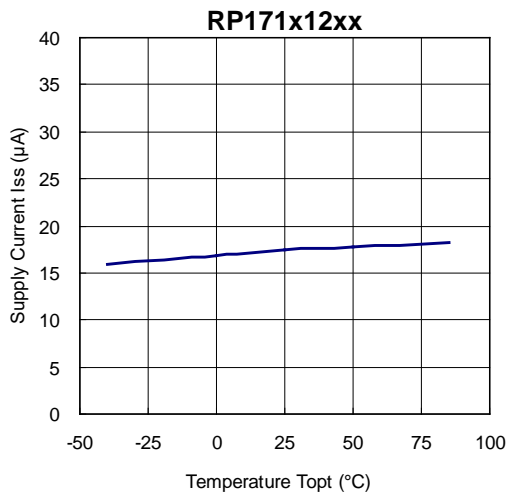

7) Dropout Voltage vs. Output Current

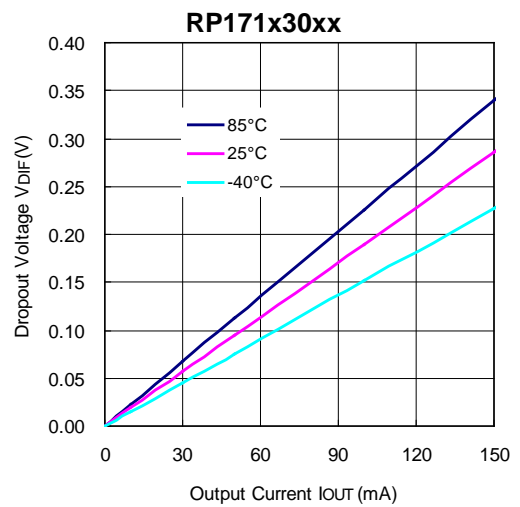
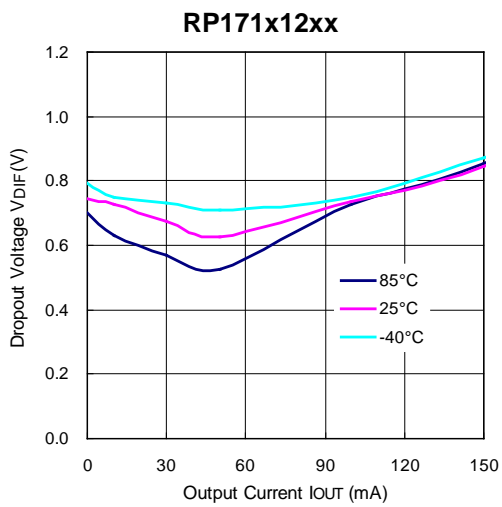

RP171x

NO.EA-245-180427

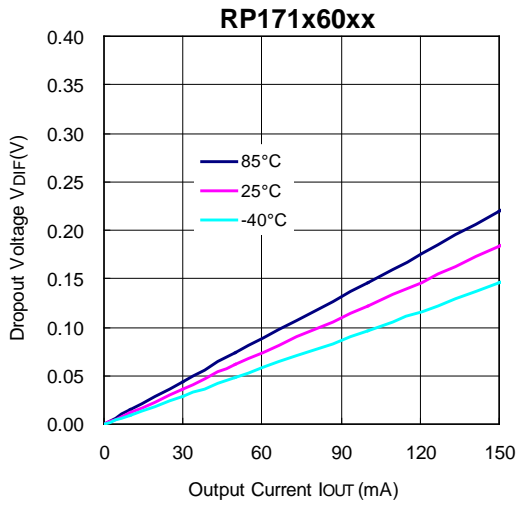

8) Dropout Voltage vs. Set Output Voltage ($T_a = 25^\circ\text{C}$)

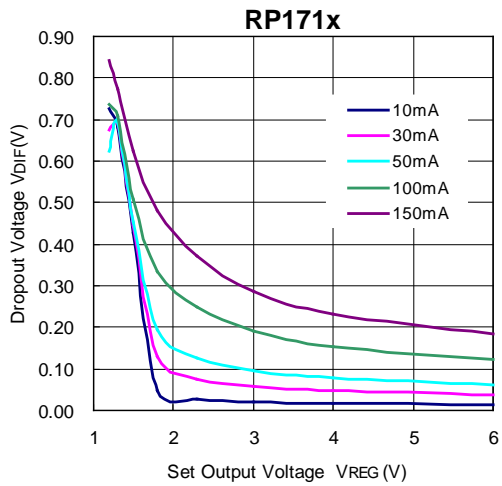

9) Minimum Operating Voltage

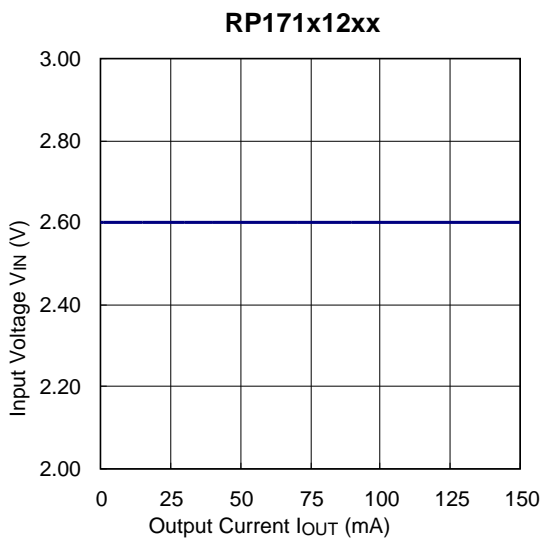

10) Ripple Rejection vs. Input Bias Voltage (C1=none, C2=Ceramic 1.0μF, Ripple=0.2Vp-p, Ta = 25°C)

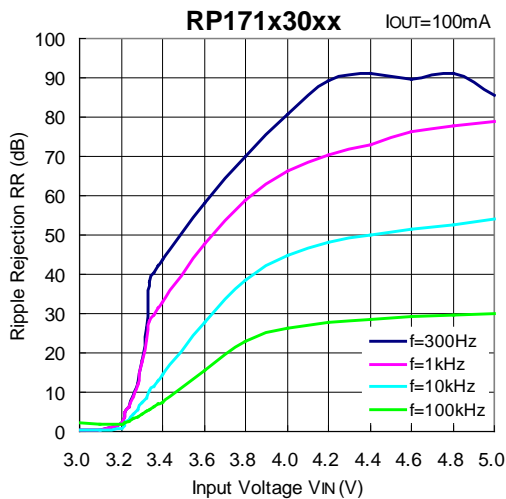
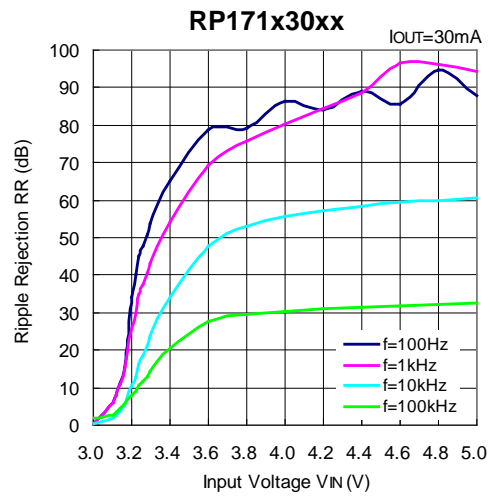
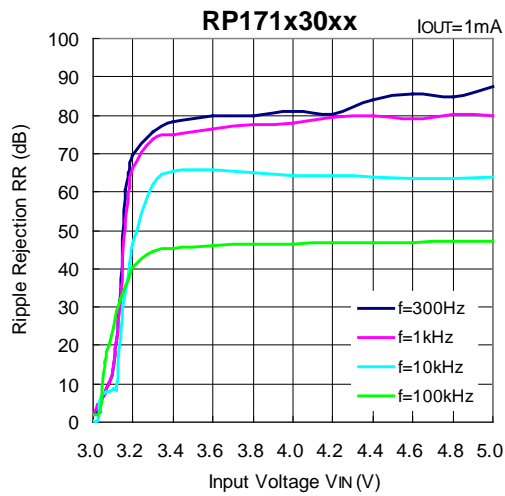

11) Ripple Rejection vs. Frequency (C1=none, C2=Ceramic 1.0μF, Ta=25°C)

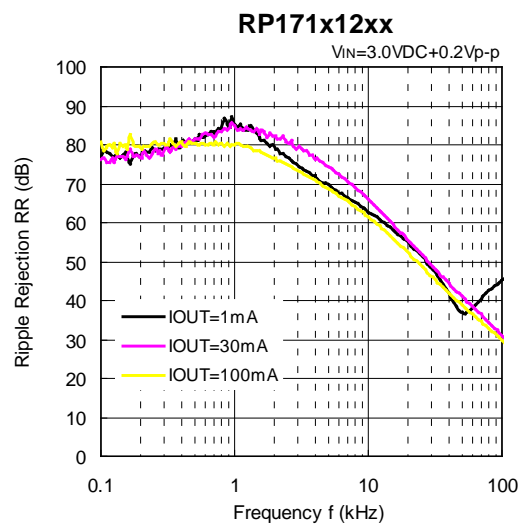
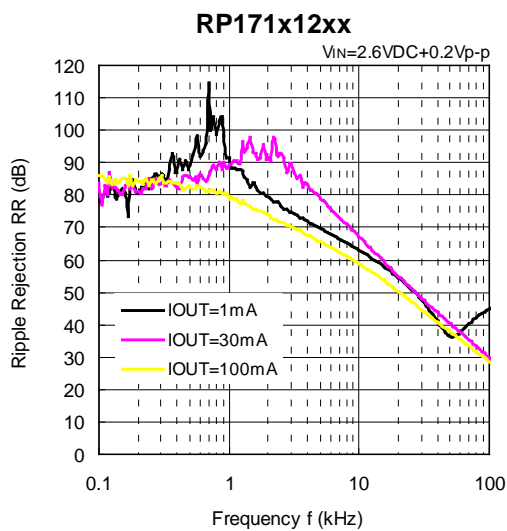

RP171x

NO.EA-245-180427

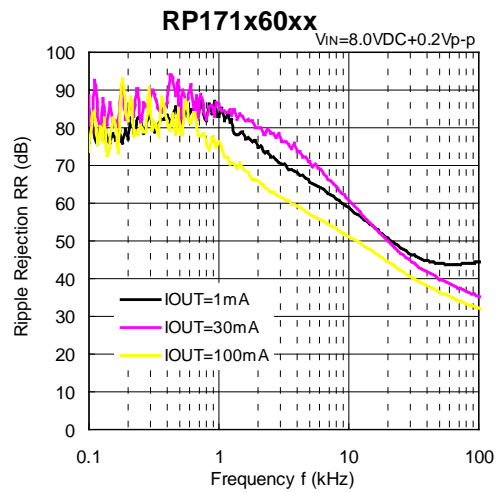
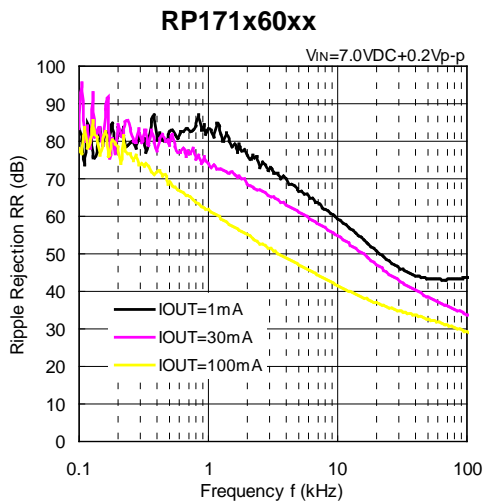
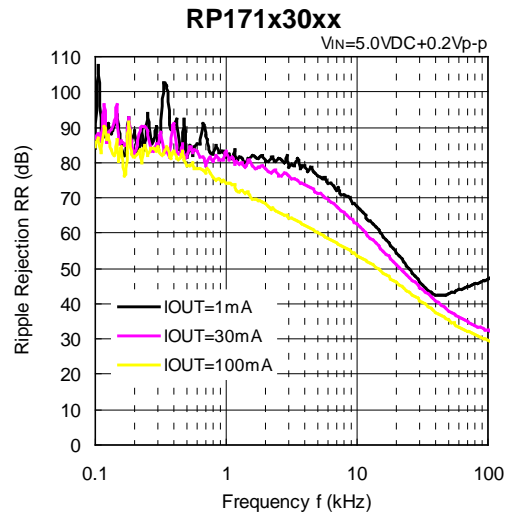
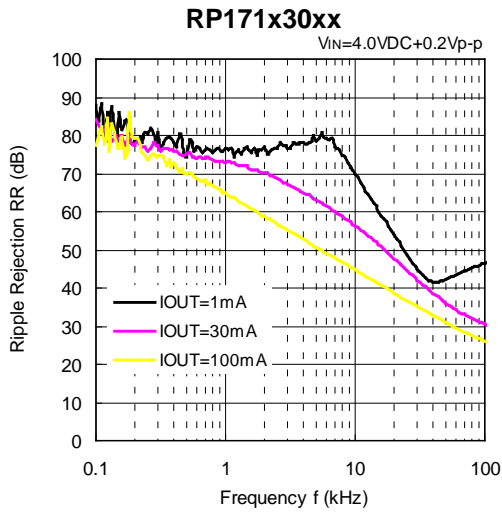

12) Input Transient Response (C1=none, IOUT=30mA, tr=tf=5μs, Ta=25°C)

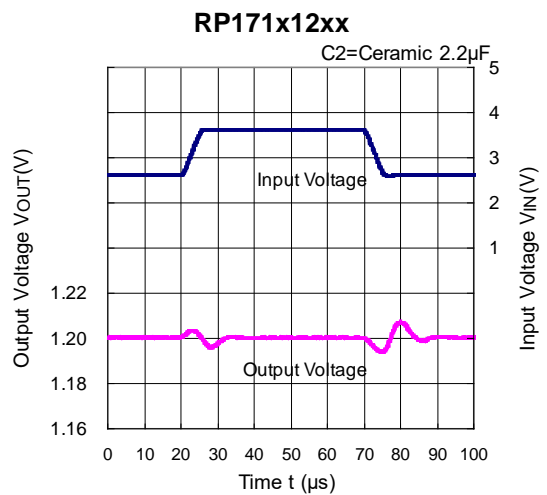
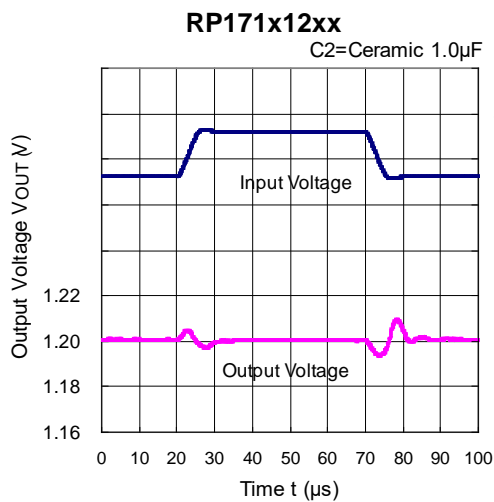

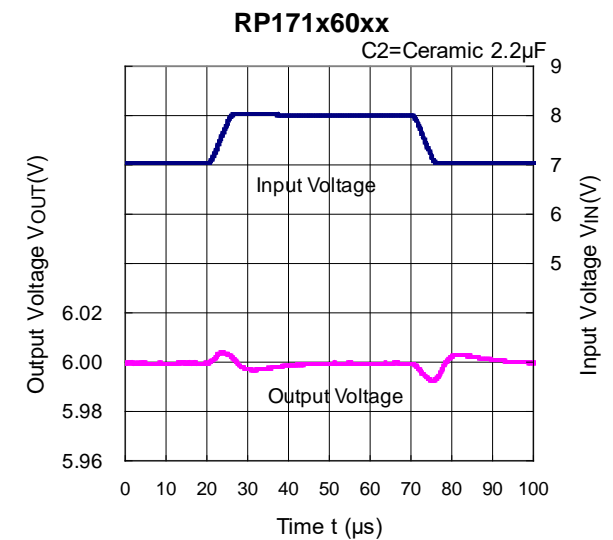
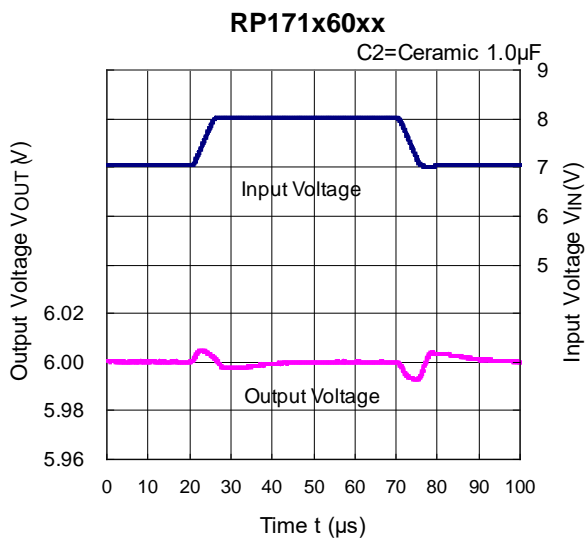
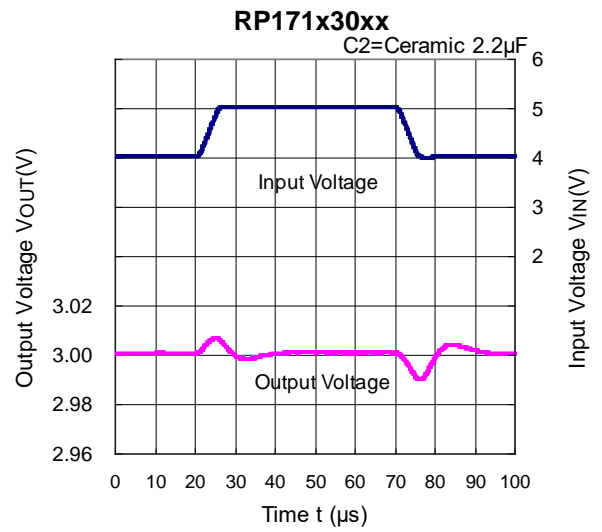
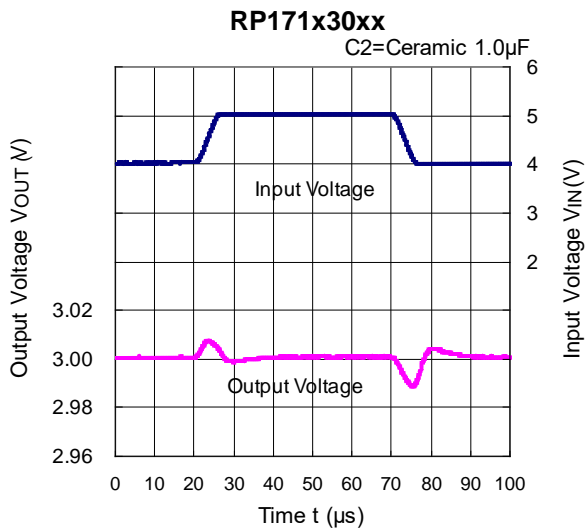

13) Load Transient Response (C1=Ceramic 1.0 μ F, $t_r=t_f=500ns$, $T_a=25^\circ C$)

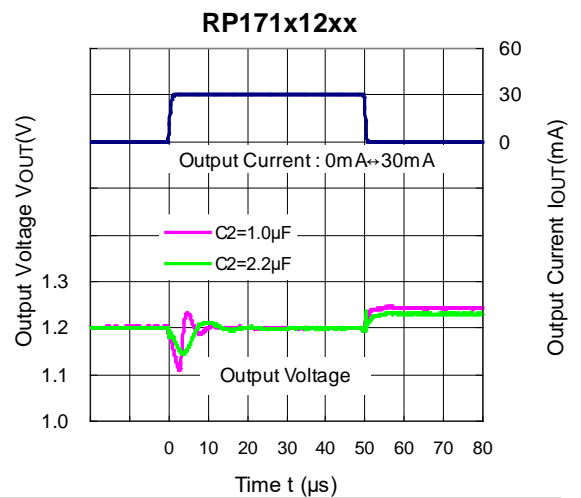
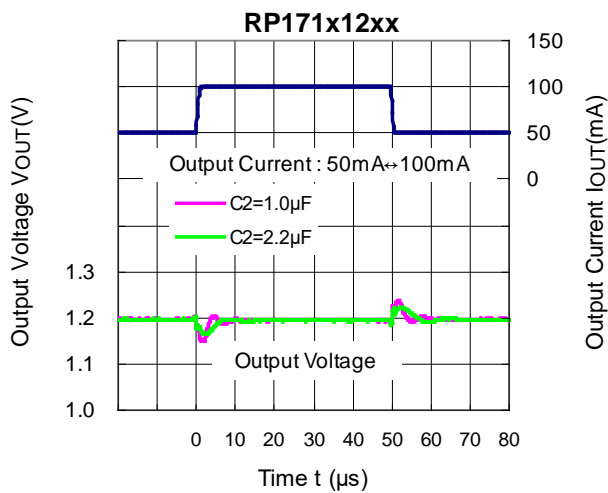

RP171x

NO.EA-245-180427

RP171x12xx

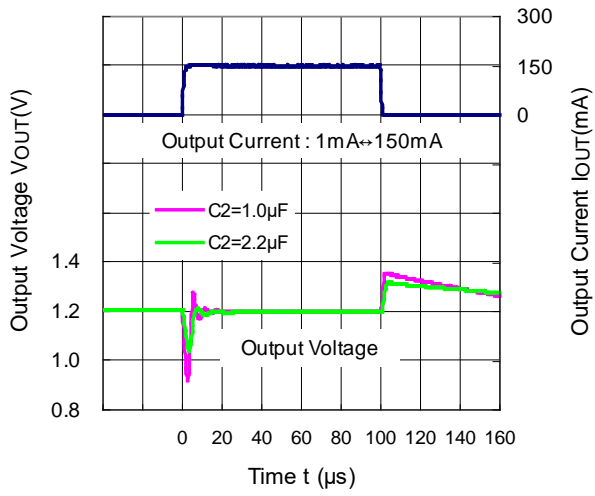

RP171x30xx

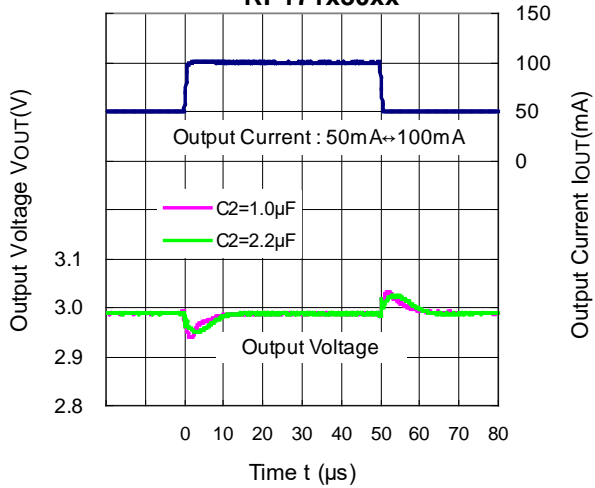

RP171x30xx

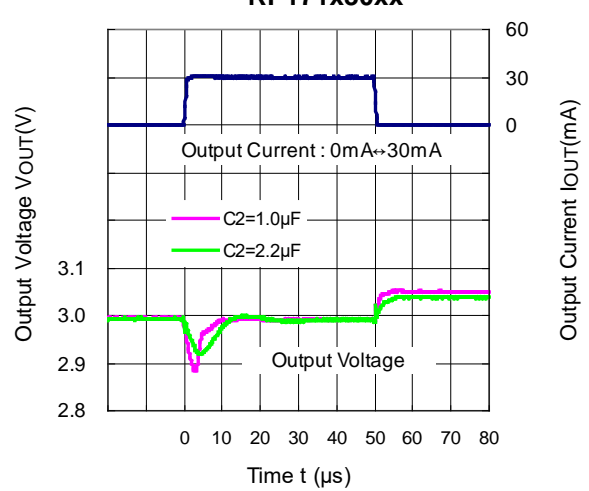

RP171x30xx

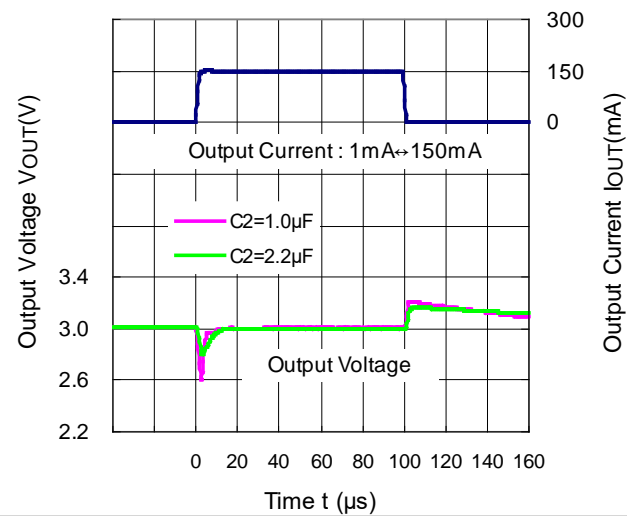

RP171x60xx

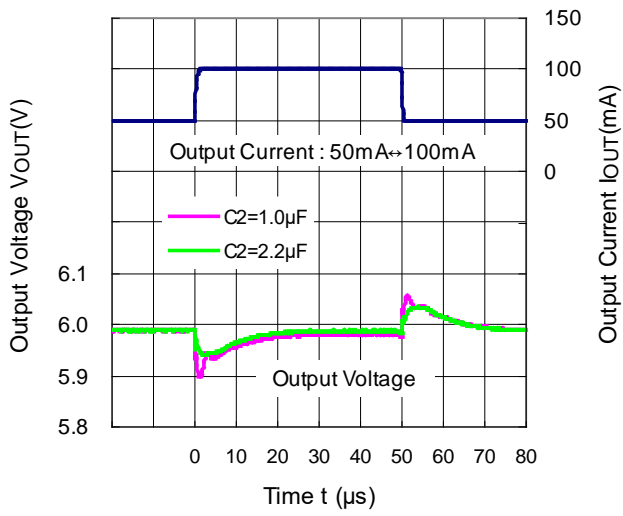

RP171x60xx

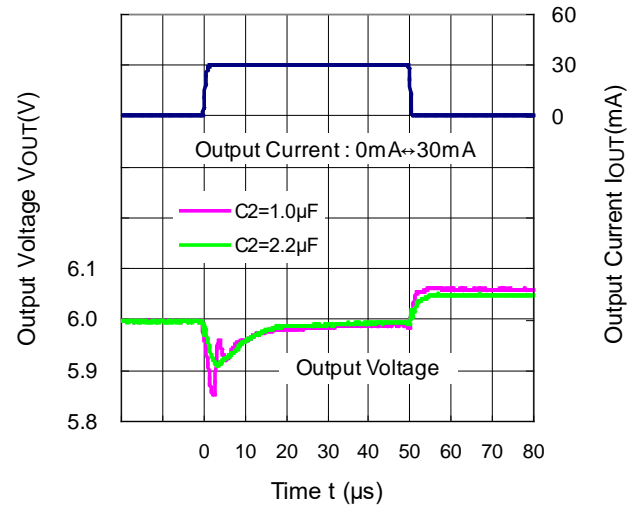

RP171x60xx

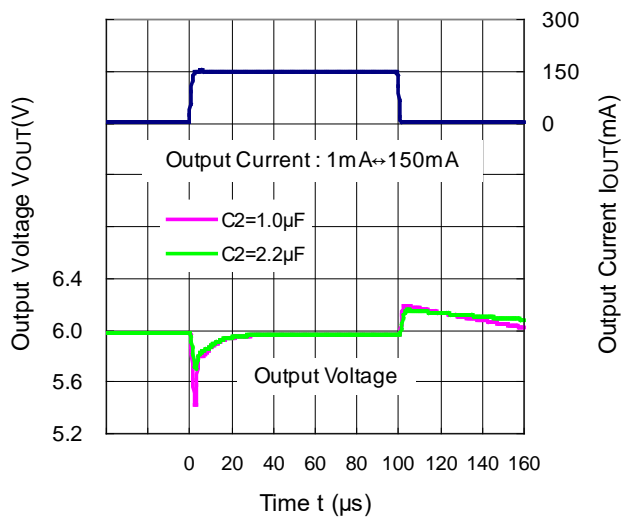

RP171x

NO.EA-245-180427

14) Turn On Speed with CE pin (C1=Ceramic 1.0 μ F, Ta=25°C)

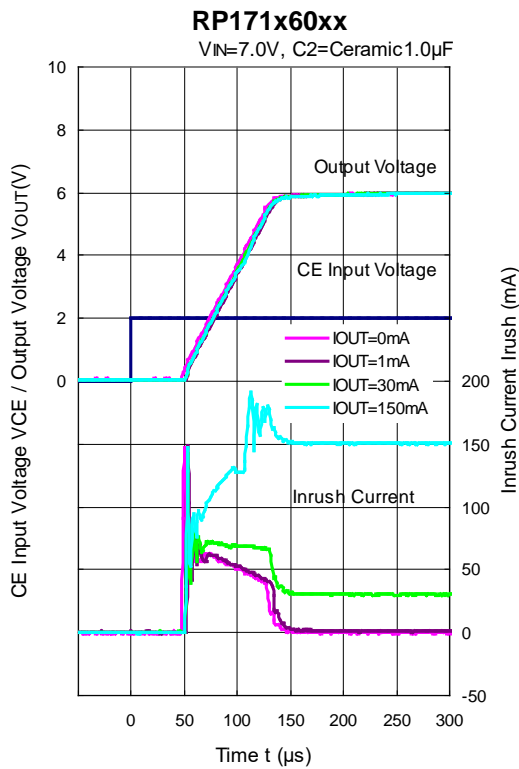
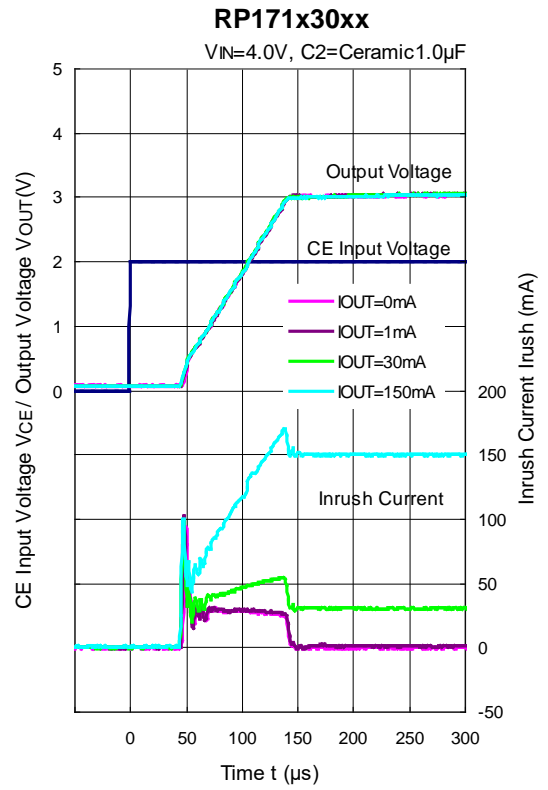
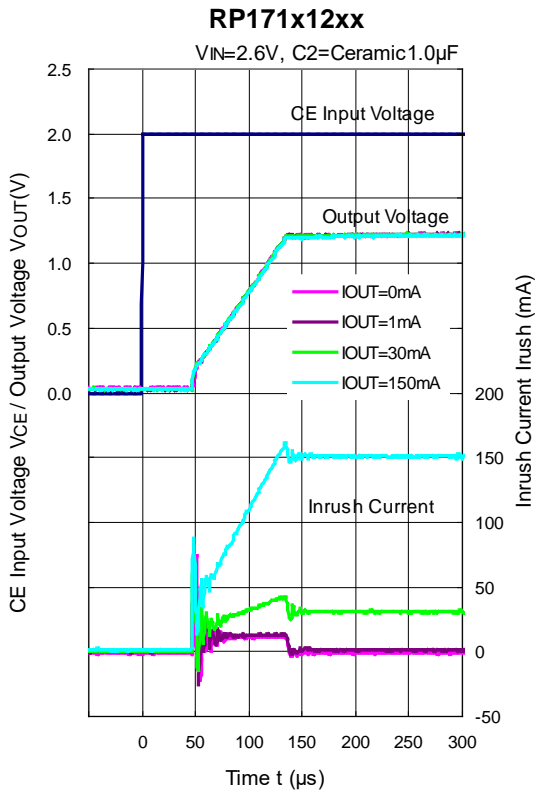

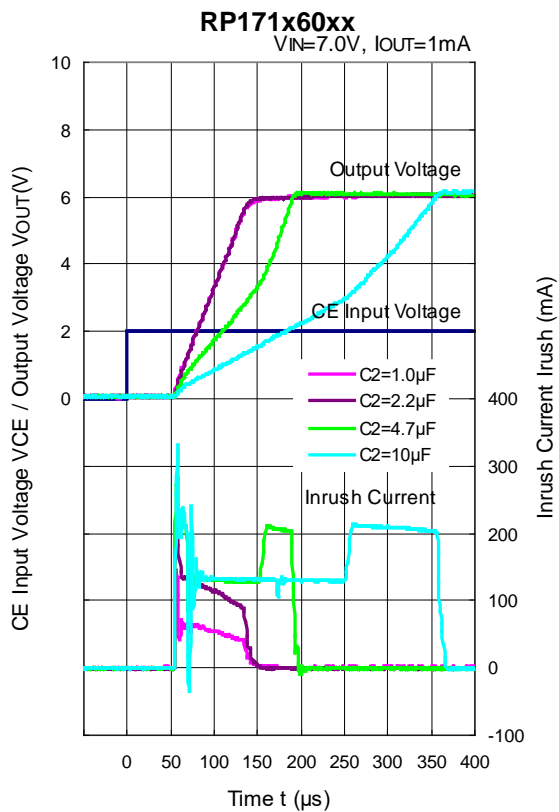
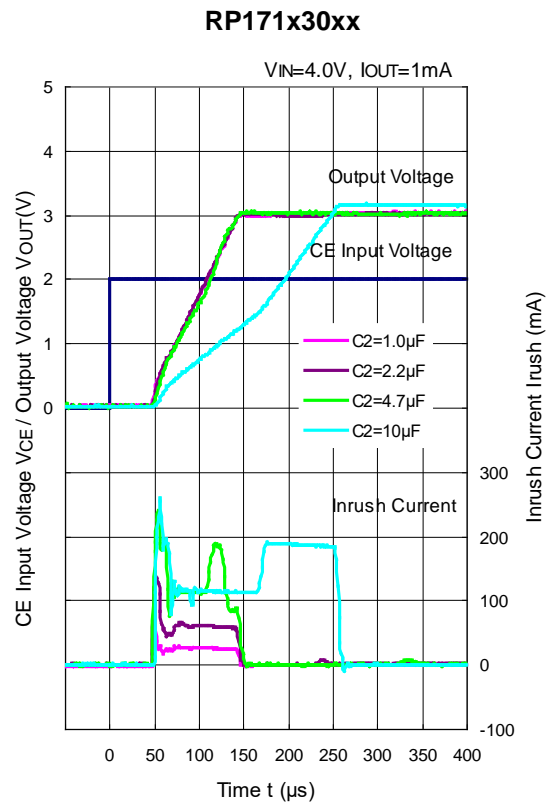
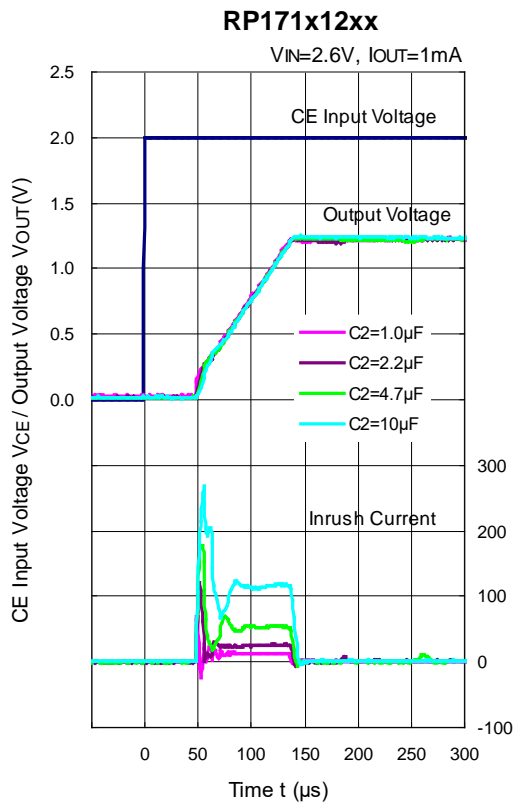

RP171x

NO.EA-245-180427

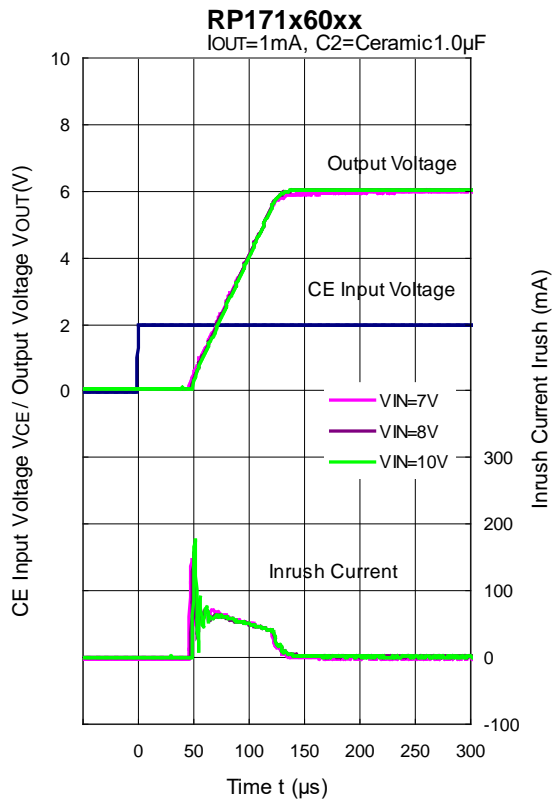
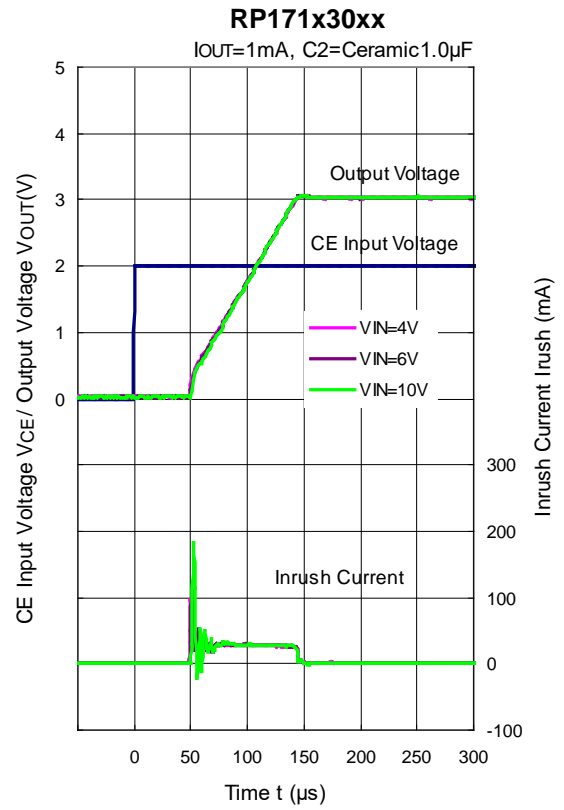
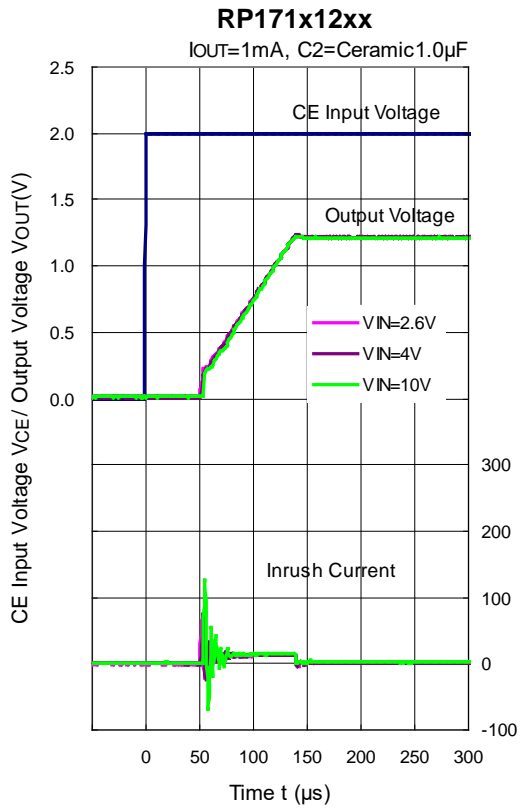

15) Turn Off Speed with CE pin (D Version) (C1=Ceramic 1.0 μ F, Ta=25°C)

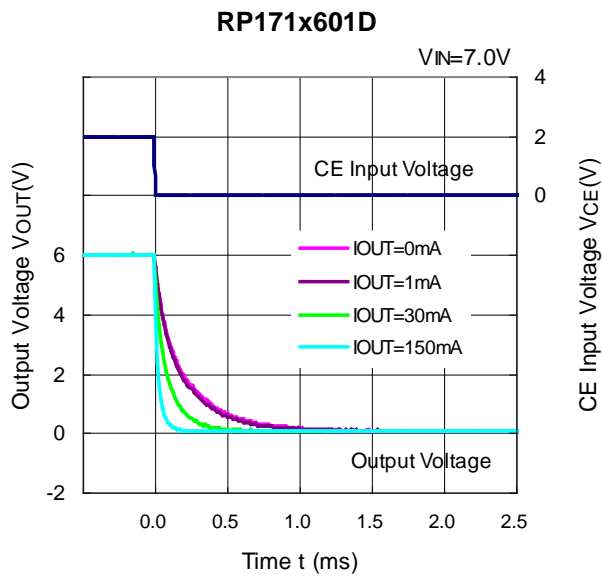
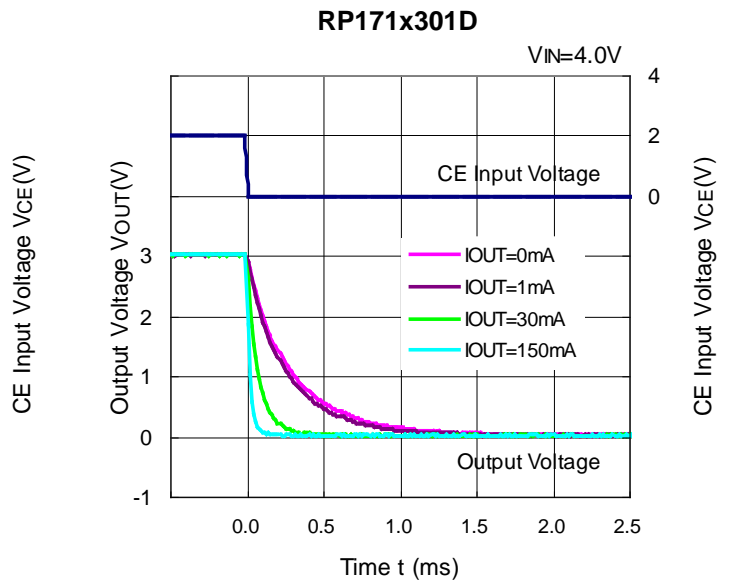
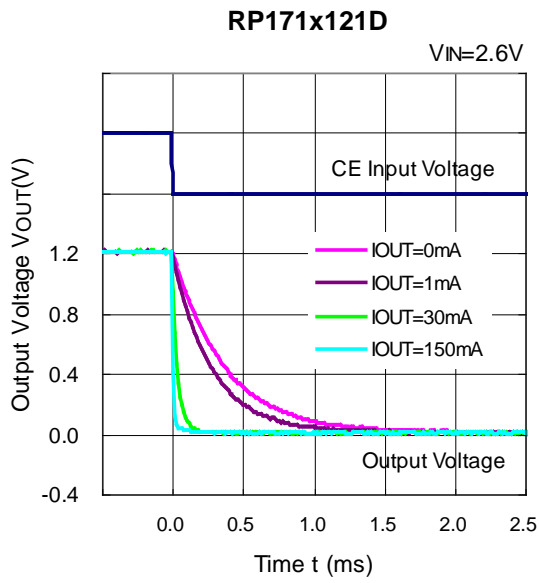

The power dissipation of the package is dependent on PCB material, layout, and environmental conditions. The following conditions are used in this measurement.

Measurement Conditions

Item	Standard Test Land Pattern
Environment	Mounting on Board (Wind Velocity = 0 m/s)
Board Material	Glass Cloth Epoxy Plastic (Double-Sided Board)
Board Dimensions	40 mm × 40 mm × 1.6 mm
Copper Ratio	Top Side: Approx. 50% Bottom Side: Approx. 50%
Through-holes	φ 0.5 mm × 44 pcs

Measurement Result

(Ta = 25°C, Tjmax = 125°C)

Item	Standard Test Land Pattern
Power Dissipation	380 mW
Thermal Resistance (θja)	θja = 263°C/W
Thermal Characterization Parameter (ψjt)	ψjt = 75°C/W

θja: Junction-to-Ambient Thermal Resistance

ψjt: Junction-to-Top Thermal Characterization Parameter

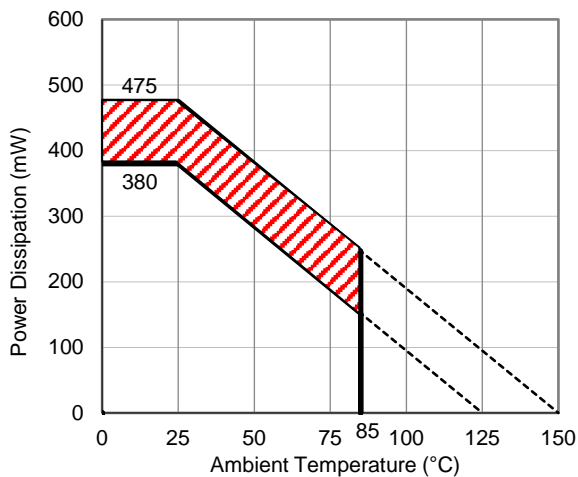

Power Dissipation vs. Ambient Temperature

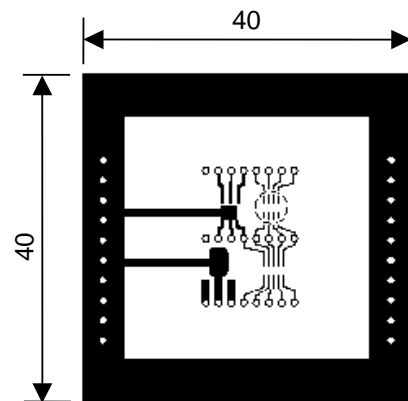

Measurement Board Pattern

The above graph shows the power dissipation of the package at Tjmax = 125°C and Tjmax = 150°C. Operating the device in the hatched range might have a negative influence on its lifetime. The total hours of use and the total years of use must be limited as follows:

Total Hours of Use	Total Years of Use (4 hours/day)
13,000 hours	9 years

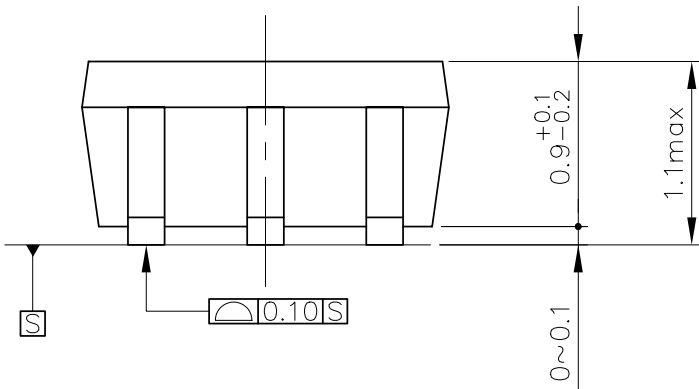
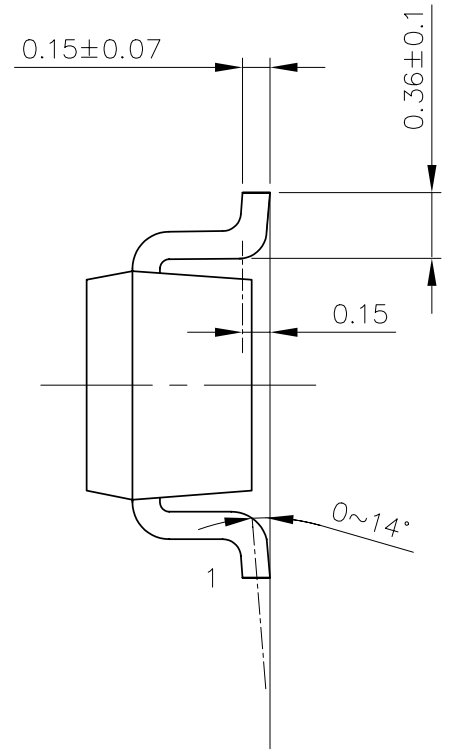
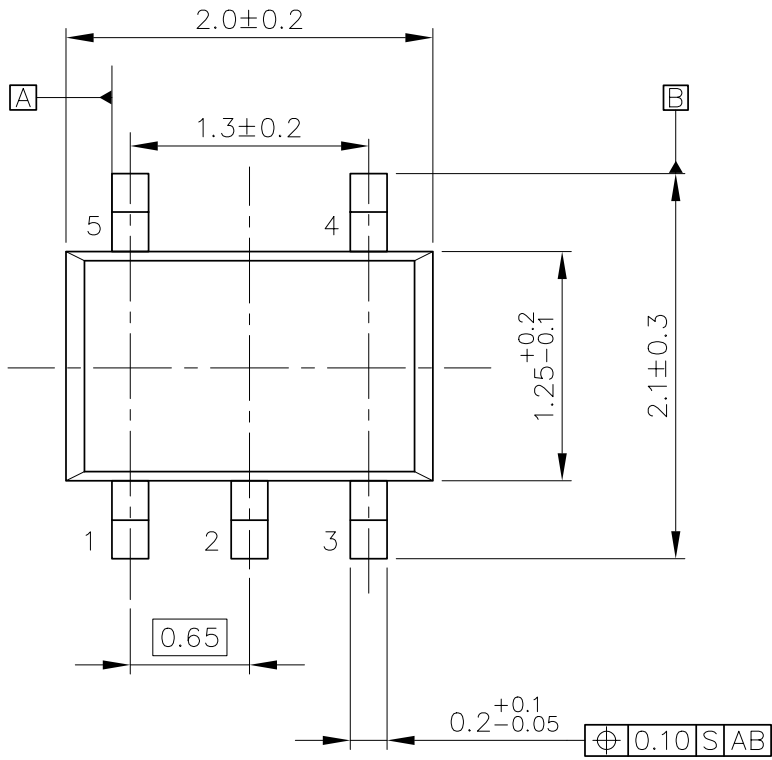

UNIT: mm

SC-88A Package Dimensions

The power dissipation of the package is dependent on PCB material, layout, and environmental conditions. The following measurement conditions are based on JEDEC STD. 51-7.

Measurement Conditions

Item	Measurement Conditions
Environment	Mounting on Board (Wind Velocity = 0 m/s)
Board Material	Glass Cloth Epoxy Plastic (Four-Layer Board)
Board Dimensions	76.2 mm × 114.3 mm × 0.8 mm
Copper Ratio	Outer Layer (First Layer): Less than 95% of 50 mm Square Inner Layers (Second and Third Layers): Approx. 100% of 50 mm Square Outer Layer (Fourth Layer): Approx. 100% of 50 mm Square
Through-holes	φ 0.3 mm × 7 pcs

Measurement Result

(Ta = 25°C, Tjmax = 125°C)

Item	Measurement Result
Power Dissipation	660 mW
Thermal Resistance (θja)	θja = 150°C/W
Thermal Characterization Parameter (ψjt)	ψjt = 51°C/W

θja: Junction-to-Ambient Thermal Resistance

ψjt: Junction-to-Top Thermal Characterization Parameter

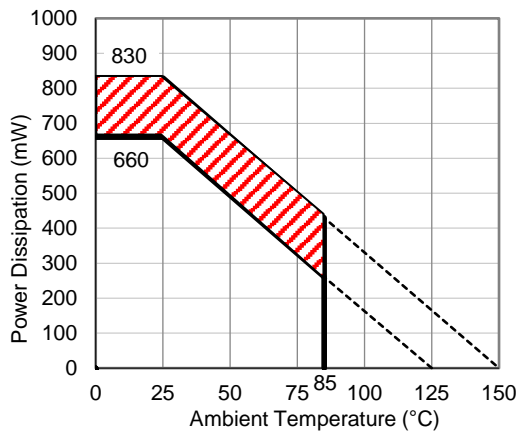

Power Dissipation vs. Ambient Temperature

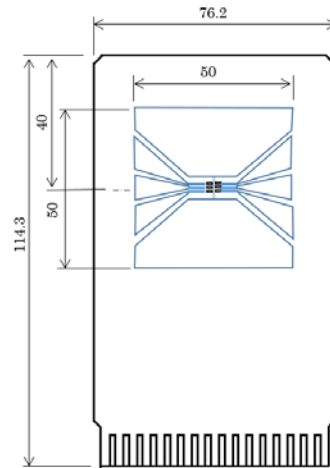

Measurement Board Pattern

The above graph shows the power dissipation of the package at Tjmax = 125°C and Tjmax = 150°C. Operating the device in the hatched range might have a negative influence on its lifetime. The total hours of use and the total years of use must be limited as follows:

Total Hours of Use	Total Years of Use (4 hours/day)
13,000 hours	9 years

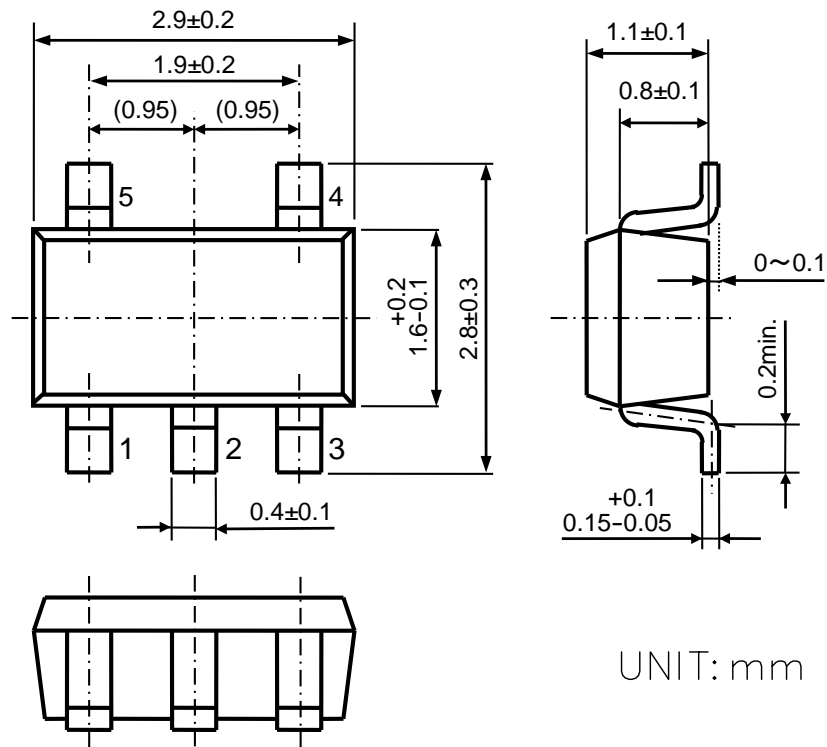

UNIT: mm

SOT-23-5 Package Dimensions



1. The products and the product specifications described in this document are subject to change or discontinuation of production without notice for reasons such as improvement. Therefore, before deciding to use the products, please refer to Ricoh sales representatives for the latest information thereon.
2. The materials in this document may not be copied or otherwise reproduced in whole or in part without prior written consent of Ricoh.
3. Please be sure to take any necessary formalities under relevant laws or regulations before exporting or otherwise taking out of your country the products or the technical information described herein.
4. The technical information described in this document shows typical characteristics of and example application circuits for the products. The release of such information is not to be construed as a warranty of or a grant of license under Ricoh's or any third party's intellectual property rights or any other rights.
5. The products listed in this document are intended and designed for use as general electronic components in standard applications (office equipment, telecommunication equipment, measuring instruments, consumer electronic products, amusement equipment etc.). Those customers intending to use a product in an application requiring extreme quality and reliability, for example, in a highly specific application where the failure or misoperation of the product could result in human injury or death (aircraft, spacevehicle, nuclear reactor control system, traffic control system, automotive and transportation equipment, combustion equipment, safety devices, life support system etc.) should first contact us.
6. We are making our continuous effort to improve the quality and reliability of our products, but semiconductor products are likely to fail with certain probability. In order to prevent any injury to persons or damages to property resulting from such failure, customers should be careful enough to incorporate safety measures in their design, such as redundancy feature, fire containment feature and fail-safe feature. We do not assume any liability or responsibility for any loss or damage arising from misuse or inappropriate use of the products.
7. Anti-radiation design is not implemented in the products described in this document.
8. The X-ray exposure can influence functions and characteristics of the products. Confirm the product functions and characteristics in the evaluation stage.
9. WLCSP products should be used in light shielded environments. The light exposure can influence functions and characteristics of the products under operation or storage.
10. There can be variation in the marking when different AOI (Automated Optical Inspection) equipment is used. In the case of recognizing the marking characteristic with AOI, please contact Ricoh sales or our distributor before attempting to use AOI.
11. Please contact Ricoh sales representatives should you have any questions or comments concerning the products or the technical information.



Ricoh is committed to reducing the environmental loading materials in electrical devices with a view to contributing to the protection of human health and the environment.

Ricoh has been providing RoHS compliant products since April 1, 2006 and Halogen-free products since April 1, 2012.

RICOH RICOH ELECTRONIC DEVICES CO., LTD.

<https://www.e-devices.ricoh.co.jp/en/>

Sales & Support Offices

Ricoh Electronic Devices Co., Ltd.

Shin-Yokohama Office (International Sales)

2-3, Shin-Yokohama 3-chome, Kohoku-ku, Yokohama-shi, Kanagawa, 222-8530, Japan
Phone: +81-50-3814-7687 Fax: +81-45-474-0074

Ricoh Americas Holdings, Inc.

675 Campbell Technology Parkway, Suite 200 Campbell, CA 95008, U.S.A.
Phone: +1-408-610-3105

Ricoh Europe (Netherlands) B.V.

Semiconductor Support Centre

Prof. W.H. Keesomlaan 1, 1183 DJ Amstelveen, The Netherlands
Phone: +31-20-5474-309

Ricoh International B.V. - German Branch

Semiconductor Sales and Support Centre

Oberrather Strasse 6, 40472 Düsseldorf, Germany
Phone: +49-211-6546-0

Ricoh Electronic Devices Korea Co., Ltd.

3F, Haesung Bldg, 504, Teheran-ro, Gangnam-gu, Seoul, 135-725, Korea
Phone: +82-2-2135-5700 Fax: +82-2-2051-5713

Ricoh Electronic Devices Shanghai Co., Ltd.

Room 403, No.2 Building, No.690 Bibo Road, Pu Dong New District, Shanghai 201203,
People's Republic of China
Phone: +86-21-5027-3200 Fax: +86-21-5027-3299

Ricoh Electronic Devices Shanghai Co., Ltd.

Shenzhen Branch

1205, Block D (Jinlong Building), Kingkey 100, Hongbao Road, Luohu District,
Shenzhen, China
Phone: +86-755-8348-7600 Ext 225

Ricoh Electronic Devices Co., Ltd.

Taipei office

Room 109, 10F-1, No.51, Hengyang Rd., Taipei City, Taiwan
Phone: +886-2-2313-1621/1622 Fax: +886-2-2313-1623

Mouser Electronics

Authorized Distributor

Click to View Pricing, Inventory, Delivery & Lifecycle Information:

[Ricoch Electronics:](#)

[RP171N361D-TR-FE](#)



Компания «ЭлектроПласт» предлагает заключение долгосрочных отношений при поставках импортных электронных компонентов на взаимовыгодных условиях!

Наши преимущества:

- Оперативные поставки широкого спектра электронных компонентов отечественного и импортного производства напрямую от производителей и с крупнейших мировых складов;
- Поставка более 17-ти миллионов наименований электронных компонентов;
- Поставка сложных, дефицитных, либо снятых с производства позиций;
- Оперативные сроки поставки под заказ (от 5 рабочих дней);
- Экспресс доставка в любую точку России;
- Техническая поддержка проекта, помощь в подборе аналогов, поставка прототипов;
- Система менеджмента качества сертифицирована по Международному стандарту ISO 9001;
- Лицензия ФСБ на осуществление работ с использованием сведений, составляющих государственную тайну;
- Поставка специализированных компонентов (Xilinx, Altera, Analog Devices, Intersil, Interpoint, Microsemi, Aeroflex, Peregrine, Syfer, Eurofarad, Texas Instrument, Miteq, Cobham, E2V, MA-COM, Hittite, Mini-Circuits, General Dynamics и др.);

Помимо этого, одним из направлений компании «ЭлектроПласт» является направление «Источники питания». Мы предлагаем Вам помощь Конструкторского отдела:

- Подбор оптимального решения, техническое обоснование при выборе компонента;
- Подбор аналогов;
- Консультации по применению компонента;
- Поставка образцов и прототипов;
- Техническая поддержка проекта;
- Защита от снятия компонента с производства.



Как с нами связаться

Телефон: 8 (812) 309 58 32 (многоканальный)

Факс: 8 (812) 320-02-42

Электронная почта: org@eplast1.ru

Адрес: 198099, г. Санкт-Петербург, ул. Калинина, дом 2, корпус 4, литера А.