

## X5043, X5045

4K, 512 x 8 Bit CPU Supervisor with 4K SPI EEPROM

FN8126

Rev 3.00

September 23, 2015

These devices combine four popular functions, Power-on Reset Control, Watchdog Timer, Supply Voltage Supervision, and Block Lock Protect Serial EEPROM Memory in one package. This combination lowers system cost, reduces board space requirements, and increases reliability.

Applying power to the device activates the power-on reset circuit which holds  $\overline{\text{RESET}}/\text{RESET}$  active for a period of time. This allows the power supply and oscillator to stabilize before the processor executes code.

The Watchdog Timer provides an independent protection mechanism for microcontrollers. When the microcontroller fails to restart a timer within a selectable time out interval, the device activates the  $\overline{\text{RESET}}/\text{RESET}$  signal. The user selects the interval from three preset values. Once selected, the interval does not change, even after cycling the power.

The device's low  $V_{CC}$  detection circuitry protects the user's system from low voltage conditions, resetting the system when  $V_{CC}$  falls below the minimum  $V_{CC}$  trip point.

$\overline{\text{RESET}}/\text{RESET}$  is asserted until  $V_{CC}$  returns to proper operating level and stabilizes. Four industry standard  $V_{TRIP}$  thresholds are available, however, Intersil's unique circuits allow the threshold to be reprogrammed to meet custom requirements or to fine-tune the threshold for applications requiring higher precision.

The memory portion of the device is a CMOS Serial EEPROM array with Intersil's block lock protection. The array is internally organized as 512 x 8. The device features a Serial Peripheral Interface (SPI) and software protocol allowing operation on a simple four-wire bus.

The device utilizes Intersil's proprietary Direct Write™ cell, providing a minimum endurance of 100,000 cycles and a minimum data retention of 100 years.

### Features

- Low  $V_{CC}$  Detection and Reset Assertion
  - Four standard reset threshold voltages  
4.63V, 4.38V, 2.93V, 2.63V
  - Re-program low  $V_{CC}$  reset threshold voltage using special programming sequence.
  - Reset signal valid to  $V_{CC} = 1V$
- Selectable Time Out Watchdog Timer
- Long Battery Life with Low Power Consumption
  - <50 $\mu$ A max standby current, watchdog on
  - <10 $\mu$ A max standby current, watchdog off
- 4Kbits of EEPROM—1M Write Cycle Endurance
- Save Critical Data with Block Lock™ Memory
  - Protect 1/4, 1/2, all or none of EEPROM array
- Built-in Inadvertent Write Protection
  - Write enable latch
  - Write protect pin
- SPI Interface - 3.3MHz Clock Rate
- Minimize Programming Time
  - 16-byte page write mode
  - 5ms write cycle time (typical)
- Available Packages
  - 8 Ld MSOP, 8 Ld SOIC, 8 Ld PDIP
  - 14 Ld TSSOP
- Pb-Free Plus Anneal Available (RoHS Compliant)

### Applications

- Communications Equipment
  - Routers, Hubs, Switches
  - Set Top Boxes
- Industrial Systems
  - Process Control
  - Intelligent Instrumentation
- Computer Systems
  - Desktop Computers
  - Network Servers
- Battery Powered Equipment

**Typical Application**



**Block Diagram**



| X5043, X5045              |        |
|---------------------------|--------|
| STANDARD $V_{TRIP}$ LEVEL | SUFFIX |
| 4.63V (+/-2.5%)           | -4.5A  |
| 4.38V (+/-2.5%)           | -4.5   |
| 2.93V (+/-2.5%)           | -2.7A  |
| 2.63V (+/-2.5%)           | -2.7   |

See "Ordering Information" on page 3. for more details  
For Custom Settings, call Intersil.

## Ordering Information

| PART NUMBER<br>RESET<br>(ACTIVE LOW)  | PART<br>MARKING | PART NUMBER<br>RESET<br>(ACTIVE HIGH)  | PART<br>MARKING | V <sub>CC</sub><br>RANGE | V <sub>TRIP</sub><br>RANGE | TEMP<br>RANGE<br>(°C)    | PACKAGE             |
|---|-----------------|--|-----------------|--------------------------|----------------------------|--------------------------|---------------------|
| X5043PZ-4.5A (Note)   | X5043P Z AL     | X5045PZ-4.5A (Note)  | X5045P Z AL     | 4.5-5.5V                 | 4.5-4.75                   | 0 to 70                  | 8 Ld PDIP (Pb-free) |
| X5043PIZ-4.5A (Note)  | X5043P Z AM     | X5045PIZ-4.5A (Note)   | X5045P Z AM     |                          |                            | -40 to 85                | 8 Ld PDIP (Pb-free) |
| X5043S8Z-4.5A (Note)  | X5043 Z AL      | X5045S8Z-4.5A (Note)   | X5045 Z AL      |                          |                            | 0 to 70                  | 8 Ld SOIC (Pb-free) |
| X5043S8IZ-4.5A*<br>(Note)   | X5043 Z AM      | X5045S8IZ-4.5A*<br>(Note)  | X5045 Z AM      |                          |                            | -40 to 85                | 8 Ld SOIC (Pb-free) |
| X5043M8Z-4.5A<br>(Note)   | DBS             | X5045M8Z-4.5A (Note)<br><b>(No longer available,<br/>recommended<br/>replacement:<br/>X5045S8Z-4.5A)</b>       | DCB             |                          |                            | 0 to 70                  | 8 Ld MSOP (Pb-free) |
| X5043M8IZ-4.5A<br>(Note)  | DBM             | X5045M8IZ-4.5A<br>(Note) <b>(No longer<br/>available,<br/>recommended<br/>replacement:<br/>X5045S8IZ-4.5A)</b> | DBX             |                          |                            | -40 to 85                | 8 Ld MSOP (Pb-free) |
| X5043PZ (Note)  | X5043P Z        | X5045PZ (Note)   | X5045P Z        |                          | 4.25-4.5                   | 0 to 70                  | 8 Ld PDIP (Pb-free) |
| X5043PIZ (Note)   | X5043P Z I      | X5045PIZ (Note)  | X5045P Z I      |                          |                            | -40 to 85                | 8 Ld PDIP (Pb-free) |
| X5043S8Z* (Note)  | X5043 Z         | X5045S8Z* (Note)   | X5045 Z         |                          |                            | 0 to 70                  | 8 Ld SOIC (Pb-free) |
| X5043S8IZ* (Note)   | X5043 Z I       | X5045S8IZ* (Note)  | X5045 Z I       |                          |                            | -40 to 85                | 8 Ld SOIC (Pb-free) |
| X5043M8Z (Note)   | DBN             | X5045M8Z (Note) <b>(No<br/>longer available,<br/>recommended<br/>replacement:<br/>X5045S8Z)</b>                | DBY             | 0 to 70                  |                            | 8 Ld MSOP (Pb-free)      |                     |
| X5043M8IZ (Note)  | DBJ             | X5045M8IZ (Note) <b>(No<br/>longer available,<br/>recommended<br/>replacement:<br/>X5045S8IZ-2.7)</b>          | DBT             | -40 to 85                |                            | 8 Ld MSOP (Pb-free)      |                     |
| X5043V14IZ (Note)<br><b>(No longer available,<br/>recommended<br/>replacement:<br/>X5043M8IZ)</b> | X5043V Z I      | X5045V14IZ (Note) <b>(No<br/>longer available or<br/>supported)</b>  | X5045V Z I      | -40 to 85                |                            | 14 Ld TSSOP<br>(Pb-free) |                     |

**Ordering Information** (Continued)

| PART NUMBER<br>RESET<br>(ACTIVE LOW) | PART<br>MARKING | PART NUMBER<br>RESET<br>(ACTIVE HIGH)  | PART<br>MARKING | V <sub>CC</sub><br>RANGE | V <sub>TRIP</sub><br>RANGE | TEMP<br>RANGE<br>(°C) | PACKAGE                |
|--------------------------------------|-----------------|--|-----------------|--------------------------|----------------------------|-----------------------|------------------------|
| X5043PZ-2.7A (Note)                  | X5043P Z AN     | X5045PZ-2.7A (Note)  | X5045P Z AN     | 2.7-5.5V                 | 2.85-3.0                   | 0 to 70               | 8 Ld PDIP (Pb-free)    |
| X5043PIZ-2.7A (Note)                 | X5043P Z AP     | X5045PIZ-2.7A (Note)   | X5045P Z AP     |                          |                            | -40 to 85             | 8 Ld PDIP (Pb-free)    |
| X5043S8Z-2.7A*<br>(Note)             | X5043 Z AN      | X5045S8Z-2.7A (Note)   | X5045 Z AN      |                          |                            | 0 to 70               | 8 Ld SOIC (Pb-free)    |
| X5043S8IZ-2.7A*<br>(Note)            | X5043 Z AP      | X5045S8IZ-2.7A (Note)  | X5045 Z AP      |                          |                            | -40 to 85             | 8 Ld SOIC<br>(Pb-free) |
| X5043M8Z-2.7A<br>(Note)              | DBR             | X5045M8Z-2.7A (Note)<br><b>(No longer available,<br/>recommended<br/>replacement:<br/>X5045S8Z-2.7A)</b>       | DCA             |                          |                            | 0 to 70               | 8 Ld MSOP (Pb-free)    |
| X5043M8IZ-2.7A*<br>(Note)            | DBL             | X5045M8IZ-2.7A<br>(Note) <b>(No longer<br/>available,<br/>recommended<br/>replacement:<br/>X5045S8IZ-2.7A)</b> | DBW             |                          |                            | -40 to 85             | 8 Ld MSOP (Pb-free)    |
| X5043PZ-2.7 (Note)                   | X5043P Z F      | X5045PZ-2.7 (Note)   | X5045P Z F      | 2.55-2.7                 | 2.55-2.7                   | 0 to 70               | 8 Ld PDIP (Pb-free)    |
| X5043PIZ-2.7 (Note)                  | X5043P Z G      | X5045PIZ-2.7 (Note)  | X5045P Z G      |                          |                            | -40 to 85             | 8 Ld PDIP (Pb-free)    |
| X5043S8Z-2.7* (Note)                 | X5043 Z F       | X5045S8Z-2.7* (Note)   | X5045 Z F       |                          |                            | 0 to 70               | 8 Ld SOIC (Pb-free)    |
| X5043S8IZ-2.7* (Note)                | X5043 Z G       | X5045S8IZ-2.7* (Note)  | X5045 Z G       |                          |                            | -40 to 85             | 8 Ld SOIC (Pb-free)    |
| X5043M8Z-2.7 (Note)                  | DBP             | X5045M8Z-2.7 (Note)<br><b>(No longer available,<br/>recommended<br/>replacement:<br/>X5045S8Z-2.7)</b>         | DBZ             |                          |                            | 0 to 70               | 8 Ld MSOP (Pb-free)    |
| X5043M8IZ-2.7*<br>(Note)             | DBK             | X5045M8IZ-2.7 (Note)<br><b>(No longer available,<br/>recommended<br/>replacement:<br/>X5045S8IZ-2.7)</b>       | DBU             |                          |                            | -40 to 85             | 8 Ld MSOP (Pb-free)    |

\*Add "-T1" suffix for tape and reel.

NOTE: Intersil Pb-free plus anneal products employ special Pb-free material sets; molding compounds/die attach materials and 100% matte tin plate termination finish, which are RoHS compliant and compatible with both SnPb and Pb-free soldering operations. Intersil Pb-free products are MSL classified at Pb-free peak reflow temperatures that meet or exceed the Pb-free requirements of IPC/JEDEC J STD-020.

## Pin Configuration

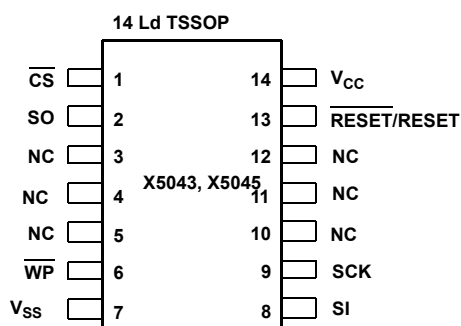
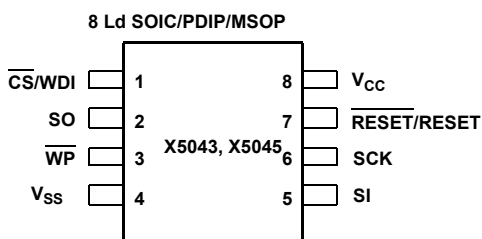

## Pin Descriptions

### Serial Output (SO)

SO is a push/pull serial data output pin. During a read cycle, data is shifted out on this pin. Data is clocked out by the falling edge of the serial clock.

### Serial Input (SI)

SI is the serial data input pin. All opcodes, byte addresses, and data to be written to the memory are input on this pin. Data is latched by the rising edge of the serial clock.

### Serial Clock (SCK)

The Serial Clock controls the serial bus timing for data input and output. Opcodes, addresses, or data present on the SI pin is latched on the rising edge of the clock input, while data on the SO pin changes after the falling edge of the clock input.

### Chip Select ( $\overline{\text{CS}}/\text{WDI}$ )

When  $\overline{\text{CS}}$  is high, the X5043, X5045 are deselected and the SO output pin is at high impedance and, unless an internal write operation is underway, the X5043, X5045 will be in the standby power mode.  $\overline{\text{CS}}$  low enables the X5043, X5045, placing it in the active power mode. It should be noted that after power-up, a high to low transition on  $\overline{\text{CS}}$  is required prior to the start of any operation.

### Write Protect ( $\overline{\text{WP}}$ )

When  $\overline{\text{WP}}$  is low, nonvolatile writes to the X5043, X5045 are disabled, but the part otherwise functions normally. When  $\overline{\text{WP}}$  is held high, all functions, including non volatile writes operate normally.  $\overline{\text{WP}}$  going low while  $\overline{\text{CS}}$  is still low will interrupt a write to the X5043, X5045. If the internal write cycle has already been initiated,  $\overline{\text{WP}}$  going low will have no effect on a write.

## Reset ( $\overline{\text{RESET}}$ , RESET)

X5043, X5045,  $\overline{\text{RESET}}/\text{RESET}$  is an active low/HIGH, open drain output which goes active whenever  $V_{\text{CC}}$  falls below the minimum  $V_{\text{CC}}$  sense level. It will remain active until  $V_{\text{CC}}$  rises above the minimum  $V_{\text{CC}}$  sense level for 200ms.

$\overline{\text{RESET}}/\text{RESET}$  also goes active if the Watchdog timer is enabled and  $\overline{\text{CS}}$  remains either high or low longer than the Watchdog time out period. A falling edge of  $\overline{\text{CS}}$  will reset the watchdog timer.

## Pin Names

| SYMBOL                                 | DESCRIPTION         |
|--|---------------------|
| $\overline{\text{CS}}/\text{WDI}$      | Chip Select Input   |
| SO                                     | Serial Output       |
| SI                                     | Serial Input        |
| SCK                                    | Serial Clock Input  |
| WP                                     | Write Protect Input |
| $V_{\text{SS}}$                        | Ground              |
| $V_{\text{CC}}$                        | Supply Voltage      |
| $\overline{\text{RESET}}/\text{RESET}$ | Reset Output        |

## Principles of Operation

### Power-on Reset

Application of power to the X5043, X5045 activate a Power-on Reset Circuit. This circuit pulls the  $\overline{\text{RESET}}/\text{RESET}$  pin active.  $\overline{\text{RESET}}/\text{RESET}$  prevents the system microprocessor from starting to operate with insufficient voltage or prior to stabilization of the oscillator. When  $V_{\text{CC}}$  exceeds the device  $V_{\text{TRIP}}$  value for 200ms (nominal) the circuit releases  $\overline{\text{RESET}}/\text{RESET}$ , allowing the processor to begin executing code.

### Low Voltage Monitoring

During operation, the X5043, X5045 monitor the  $V_{\text{CC}}$  level and asserts  $\overline{\text{RESET}}/\text{RESET}$  if supply voltage falls below a preset minimum  $V_{\text{TRIP}}$ . The  $\overline{\text{RESET}}/\text{RESET}$  signal prevents the microprocessor from operating in a power fail or brownout condition. The  $\overline{\text{RESET}}/\text{RESET}$  signal remains active until the voltage drops below 1V. It also remains active until  $V_{\text{CC}}$  returns and exceeds  $V_{\text{TRIP}}$  for 200ms.

### Watchdog Timer

The Watchdog Timer circuit monitors the microprocessor activity by monitoring the WDI input. The microprocessor must toggle the  $\overline{\text{CS}}/\text{WDI}$  pin periodically to prevent an active  $\overline{\text{RESET}}/\text{RESET}$  signal. The  $\overline{\text{CS}}/\text{WDI}$  pin must be toggled from HIGH to LOW prior to the expiration of the watchdog time out period. The state of two nonvolatile control bits in the Status Register determines the watchdog timer period. The microprocessor can change these watchdog bits. With no microprocessor action, the watchdog timer control bits remain unchanged, even during total power failure.

**V<sub>CC</sub> Threshold Reset Procedure**

The X5043, X5045 are shipped with a standard V<sub>CC</sub> threshold (V<sub>TRIP</sub>) voltage. This value will not change over normal operating and storage conditions. However, in applications where the standard V<sub>TRIP</sub> is not exactly right, or if higher precision is needed in the V<sub>TRIP</sub> value, the X5043, X5045 threshold may be adjusted. The procedure is described below, and uses the application of a high voltage control signal.

**Setting the V<sub>TRIP</sub> Voltage**

This procedure is used to set the V<sub>TRIP</sub> to a higher voltage value. For example, if the current V<sub>TRIP</sub> is 4.4V and the new V<sub>TRIP</sub> is 4.6V, this procedure will directly make the change. If the new setting is to be lower than the current setting, then it is necessary to reset the trip point before setting the new value.

To set the new V<sub>TRIP</sub> voltage, apply the desired V<sub>TRIP</sub> threshold voltage to the V<sub>CC</sub> pin and tie the  $\overline{WP}$  pin to the programming voltage V<sub>P</sub>. Then send a WREN command, followed by a write of Data 00h to address 01h.  $\overline{CS}$  going HIGH on the write operation initiates the V<sub>TRIP</sub> programming sequence. Bring  $\overline{WP}$  LOW to complete the operation.

operation initiates the V<sub>TRIP</sub> programming sequence. Bring  $\overline{WP}$  LOW to complete the operation.

**Note:** This operation also writes 00h to array address 01h.

**Resetting the V<sub>TRIP</sub> Voltage**

This procedure is used to set the V<sub>TRIP</sub> to a “native” voltage level. For example, if the current V<sub>TRIP</sub> is 4.4V and the new V<sub>TRIP</sub> must be 4.0V, then the V<sub>TRIP</sub> must be reset. When V<sub>TRIP</sub> is reset, the new V<sub>TRIP</sub> is something less than 1.7V. This procedure must be used to set the voltage to a lower value.

To reset the V<sub>TRIP</sub> voltage, apply at least 3V to the V<sub>CC</sub> pin and tie the  $\overline{WP}$  pin to the programming voltage V<sub>P</sub>. Then send a WREN command, followed by a write of Data 00h to address 03h.  $\overline{CS}$  going HIGH on the write operation initiates the V<sub>TRIP</sub> programming sequence. Bring  $\overline{WP}$  LOW to complete the operation.

**Note:** This operation also writes 00h to array address 03h.



**FIGURE 2. RESET V<sub>TRIP</sub> LEVEL SEQUENCE (V<sub>CC</sub> > 3V.  $\overline{WP}$  = 15-18V)**



**FIGURE 1. SET V<sub>TRIP</sub> LEVEL SEQUENCE (V<sub>CC</sub> = DESIRED V<sub>TRIP</sub> VALUE.)**



FIGURE 3. SAMPLE  $V_{TRIP}$  RESET CIRCUIT

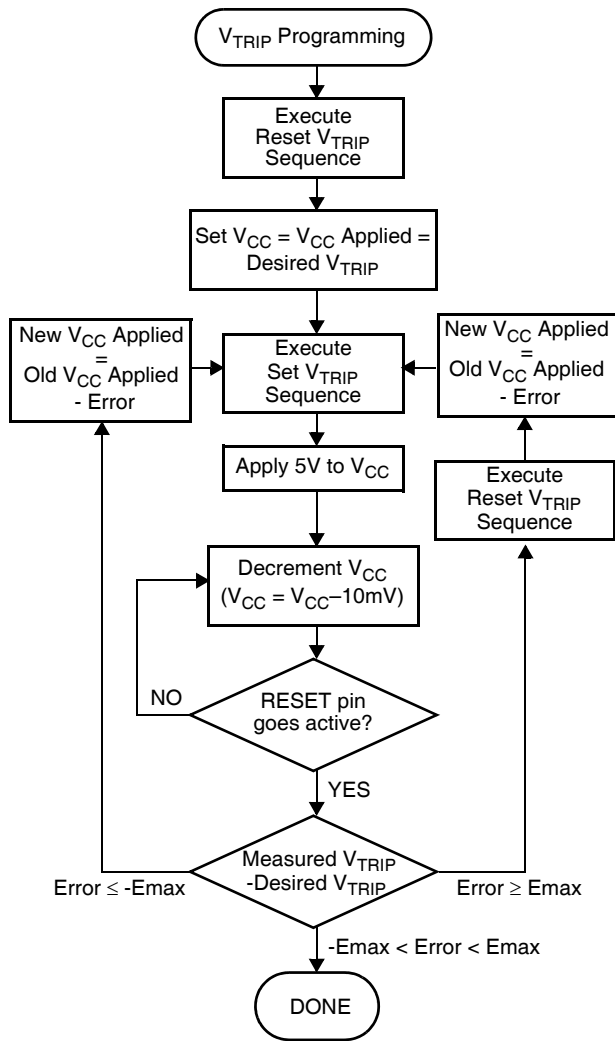

$E_{max}$  = Maximum Desired Error

FIGURE 4.  $V_{TRIP}$  PROGRAMMING SEQUENCE

### **SPI Serial Memory**

The memory portion of the device is a CMOS Serial EEPROM array with Intersil's block lock protection. The array is internally organized as 512 x 8 bits. The device features a Serial Peripheral Interface (SPI) and software protocol allowing operation on a simple four-wire bus.

The device utilizes Intersil's proprietary Direct Write™ cell, providing a minimum endurance of 1,000,000 cycles and a minimum data retention of 100 years.

The device is designed to interface directly with the synchronous Serial Peripheral Interface (SPI) of many popular microcontroller families.

The device contains an 8-bit instruction register that controls the operation of the device. The instruction code is written to the device via the SI input. There are two write operations

that requires only the instruction byte. There are two read operations that use the instruction byte to initiate the output of data. The remainder of the operations require an instruction byte, an 8-bit address, then data bytes. All instruction, address and data bits are clocked by the SCK input. All instructions (Table 1), addresses and data are transferred MSB first.

### **Clock and Data Timing**

Data input on the SI line is latched on the first rising edge of SCK after  $\overline{CS}$  goes LOW. Data is output on the SO line by the falling edge of SCK. SCK is static, allowing the user to stop the clock and then start it again to resume operations where left off.  $\overline{CS}$  must be LOW during the entire operation.

**TABLE 1. INSTRUCTION SET**

| <b>INSTRUCTION NAME</b> | <b>INSTRUCTION FORMAT*</b> | <b>OPERATION</b>   |
|-------------------------|----------------------------|--|
| WREN                    | 0000 0110                  | Set the Write Enable Latch (Enable Write Operations)                     |
| WRDI                    | 0000 0100                  | Reset the Write Enable Latch (Disable Write Operations)                  |
| RSDR                    | 0000 0101                  | Read Status Register   |
| WRSR                    | 0000 0001                  | Write Status Register (Watchdog and Block Lock)                          |
| READ                    | 0000 A <sub>8</sub> 011    | Read Data from Memory Array Beginning at Selected Address                |
| WRITE                   | 0000 A <sub>8</sub> 010    | Write Data to Memory Array Beginning at Selected Address (1 to 16 bytes) |

Note: \*Instructions are shown MSB in leftmost position. Instructions are transferred MSB first.



**Write Enable Latch**

The device contains a Write Enable Latch. This latch must be SET before a Write Operation is initiated. The WREN instruction will set the latch and the WRDI instruction will reset the latch (Figure 5). This latch is automatically reset upon a power-up condition and after the completion of a valid byte, page, or status register write cycle. The latch is also reset if  $\overline{WP}$  is brought LOW.

When issuing a WREN, WRDI or RDSR commands, it is not necessary to send a byte address or data.

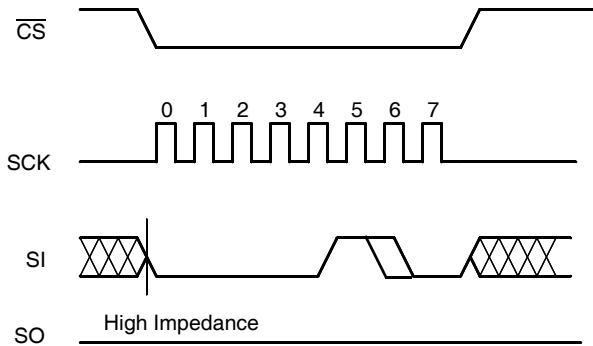

**FIGURE 5. WRITE ENABLE/DISABLE LATCH SEQUENCE (WREN/WRDI INSTRUCTION)**

**Status Register**

The Status Register contains four nonvolatile control bits and two volatile status bits. The control bits set the operation of the watchdog timer and the memory block lock protection. The Status Register is formatted as shown in “Status Register”.

**Status Register: (Default = 30H)**

|   |   |     |     |     |     |     |     |
|---|---|-----|-----|-----|-----|-----|-----|
| 7 | 6 | 5   | 4   | 3   | 2   | 1   | 0   |
| 0 | 0 | WD1 | WD0 | BL1 | BL0 | WEL | WIP |

The Write-In-Progress (WIP) bit is a volatile, read only bit and indicates whether the device is busy with an internal nonvolatile write operation. The WIP bit is read using the RDSR instruction. When set to a “1”, a nonvolatile write operation is in progress. When set to a “0”, no write is in progress.

The Write Enable Latch (WEL) bit indicates the status of the “write enable” latch. When WEL = 1, the latch is set and when WEL = 0 the latch is reset. The WEL bit is a volatile, read only bit. The WREN instruction sets the WEL bit and the WRDS instruction resets the WEL bit.

The block lock bits, BL0 and BL1, set the level of block lock protection. These nonvolatile bits are programmed using the WRSR instruction and allow the user to protect one quarter, one half, all or none of the EEPROM array. Any portion of the array that is block lock protected can be read but not written. It will remain protected until the BL bits are altered to disable block lock protection of that portion of memory.

| STATUS REG BITS |     | ARRAY ADDRESSES PROTECTED |
|-----------------|-----|---------------------------|
| BL1             | BL0 | X5043, X5045              |
| 0               | 0   | None                      |
| 0               | 1   | \$180-\$1FF               |
| 1               | 0   | \$100-\$1FF               |
| 1               | 1   | \$000-\$1FF               |

The Watchdog Timer bits, WD0 and WD1, select the Watchdog Time-out Period. These nonvolatile bits are programmed with the WRSR instruction.

| STATUS REGISTER BITS |     | WATCHDOG TIME OUT (TYPICAL) |
|----------------------|-----|-----------------------------|
| WD1                  | WD0 |                             |
| 0                    | 0   | 1.4 seconds                 |
| 0                    | 1   | 600 milliseconds            |
| 1                    | 0   | 200 milliseconds            |
| 1                    | 1   | disabled (factory default)  |

**Read Status Register**

To read the Status Register, pull  $\overline{CS}$  low to select the device, then send the 8-bit RDSR instruction. Then the contents of the Status Register are shifted out on the SO line, clocked by CLK. Refer to the Read Status Register Sequence (Figure 6). The Status Register may be read at any time, even during a Write Cycle.

**Write Status Register**

Prior to any attempt to write data into the status register, the “Write Enable” Latch (WEL) must be set by issuing the WREN instruction (Figure 5). First pull  $\overline{CS}$  LOW, then clock the WREN instruction into the device and pull  $\overline{CS}$  HIGH. Then bring  $\overline{CS}$  LOW again and enter the WRSR instruction followed by 8 bits of data. These 8 bits of data correspond to the contents of the status register. The operation ends with  $\overline{CS}$  going HIGH. If  $\overline{CS}$  does not go HIGH between WREN and WRSR, the WRSR instruction is ignored.

**TABLE 2. DEVICE PROTECT MATRIX**

| WREN CMD (WEL) | DEVICE PIN (WP) | MEMORY BLOCK   |                  | STATUS REGISTER (BL0, BL1, WD0, WD1) |
|----------------|-----------------|----------------|------------------|--------------------------------------|
|                |                 | PROTECTED AREA | UNPROTECTED AREA |                                      |
| 0              | x               | Protected      | Protected        | Protected                            |
| x              | 0               | Protected      | Protected        | Protected                            |

TABLE 2. DEVICE PROTECT MATRIX

| WREN CMD (WEL) | DEVICE PIN (WP) | MEMORY BLOCK   |                  | STATUS REGISTER (BL0, BL1, WD0, WD1) |
|----------------|-----------------|----------------|------------------|--------------------------------------|
|                |                 | PROTECTED AREA | UNPROTECTED AREA |                                      |
| 1              | 1               | Protected      | Writable         | Writable                             |



FIGURE 6. READ STATUS REGISTER SEQUENCE



FIGURE 7. WRITE STATUS REGISTER SEQUENCE

**Read Memory Array**

When reading from the EEPROM memory array,  $\overline{CS}$  is first pulled low to select the device. The 8-bit READ instruction is transmitted to the device, followed by the 8-bit address. Bit 3 of the READ instruction selects the upper or lower half of the device. After the READ opcode and address are sent, the data stored in the memory at the selected address is shifted out on the SO line. The data stored in memory at the next address can be read sequentially by continuing to provide clock pulses. The address is automatically incremented to the next higher address after each byte of data is shifted out. When the highest address is reached, the address counter rolls over to address 000h allowing the read cycle to be continued indefinitely. The read operation is terminated by taking  $\overline{CS}$  high. Refer to the Read EEPROM Array Sequence (Figure 8).

**Write Memory Array**

Prior to any attempt to write data into the memory array, the "Write Enable" Latch (WEL) must be set by issuing the WREN instruction (Figure 5). First pull  $\overline{CS}$  LOW, then clock the WREN instruction into the device and pull  $\overline{CS}$  HIGH. Then bring  $\overline{CS}$  LOW again and enter the WRITE instruction followed by the 8-bit address and then the data to be written. Bit 3 of the WRITE instruction contains address bit  $A_8$ , which selects the upper or lower half of the array. If  $\overline{CS}$  does not go HIGH between WREN and WRITE, the WRITE instruction is ignored.

The WRITE operation requires at least 16 clocks.  $\overline{CS}$  must go low and remain low for the duration of the operation. The host may continue to write up to 16 bytes of data. The only restriction is that the 16 bytes must reside within the same page. A page address begins with address [x xxxx 0000] and ends with [x xxxx 1111]. If the byte address reaches the last byte on the page and the clock continues, the counter will roll back to the first address of the page and overwrite any data that has been previously written.

For the write operation (byte or page write) to be completed,  $\overline{CS}$  must be brought HIGH after bit 0 of the last complete data

byte to be written is clocked in. If it is brought HIGH at any other time, the write operation will not be completed (Figure 9).

While the write is in progress following a status register or memory array write sequence, the Status Register may be read to check the WIP bit. WIP is HIGH while the nonvolatile write is in progress.



FIGURE 8. READ EEPROM ARRAY SEQUENCE



FIGURE 9. WRITE MEMORY SEQUENCE

**Operational Notes**

The device powers-up in the following state:

1. The device is in the low power standby state.
2. A HIGH to LOW transition on  $\overline{CS}$  is required to enter an active state and receive an instruction.
3. SO pin is high impedance.
4. The Write Enable Latch is reset.
5. The Flag Bit is reset.
6. Reset Signal is active for  $t_{PURST}$ .

**Data Protection**

The following circuitry has been included to prevent inadvertent writes:

- A WREN instruction must be issued to set the Write Enable Latch.
- $\overline{CS}$  must come HIGH at the proper clock count in order to start a nonvolatile write cycle.
- Block Protect bits provide additional level of write protection for the memory array.
- The  $\overline{WP}$  pin LOW blocks nonvolatile write operations.

**Absolute Maximum Ratings**

|   |                 |
|---|-----------------|
| Temperature under bias                      | -65°C to +135°C |
| Storage temperature                         | -65°C to +150°C |
| Voltage on any pin with respect to $V_{SS}$ | -1.0V to +7V    |
| D.C. output current                         | 5mA             |
| Lead temperature (soldering, 10 seconds)    | 300°C           |

**Recommended Operating Conditions**

|                 |              |                |
|-----------------|--------------|----------------|
| Temperature:    | Commercial   | 0°C to +70°C   |
|                 | Industrial   | -40°C to +85°C |
| Supply Voltage: | -2.7, -2.7A  | 2.7V to 5.5V   |
|                 | Blank, -4.5A | 4.5V to 5.5V   |

CAUTION: Stresses above those listed under "Absolute Maximum Ratings" may cause permanent damage to the device. This is a stress rating only; functional operation of the device (at these or any other conditions above those listed in the operational sections of this specification) is not implied. Exposure to absolute maximum rating conditions for extended periods may affect device reliability.

**DC Electrical Specifications** (Over the recommended operating conditions unless otherwise specified.)

| SYMBOL         | PARAMETER  | TEST CONDITIONS/COMMENTS  | LIMITS              |                    |                     | UNIT    |
|----------------|--|---|---------------------|--------------------|---------------------|---------|
|                |  |   | MIN                 | TYP <sup>(2)</sup> | MAX                 |         |
| $I_{CC1}$      | $V_{CC}$ Write Current (Active)                  | SCK = 3.3MHz <sup>(3)</sup> ; SO, $\overline{RESET}$ , RESET = Open             |                     |                    | 3                   | mA      |
| $I_{CC2}$      | $V_{CC}$ Read Current (Active)                   | SCK = 3.3MHz <sup>(3)</sup> ; SI = $V_{SS}$ , $\overline{RESET}$ , RESET = Open |                     |                    | 2                   | mA      |
| $I_{SB1}$      | $V_{CC}$ Standby Current WDT = OFF               | $\overline{CS} = V_{CC}$ , SCK, SI = $V_{SS}$ , $V_{CC} = 5.5V$                 |                     |                    | 10                  | $\mu A$ |
| $I_{SB2}$      | $V_{CC}$ Standby Current WDT = ON                | $\overline{CS} = V_{CC}$ , SCK, SI = $V_{SS}$ , $V_{CC} = 5.5V$                 |                     |                    | 50                  | $\mu A$ |
| $I_{LI}$       | Input Leakage Current                            | SCK, SI, WP = $V_{SS}$ to $V_{CC}$  |                     | 0.1                | 10                  | $\mu A$ |
| $I_{LO}$       | Output Leakage Current                           | SO, $\overline{RESET}$ , RESET = $V_{SS}$ to $V_{CC}$                           |                     | 0.1                | 10                  | $\mu A$ |
| $V_{IL}^{(1)}$ | Input LOW Voltage                                | SCK, SI, $\overline{WP}$ , $\overline{CS}$                                      | -0.5                |                    | $V_{CC} \times 0.3$ | V       |
| $V_{IH}^{(1)}$ | Input HIGH Voltage                               | SCK, SI, $\overline{WP}$ , $\overline{CS}$                                      | $V_{CC} \times 0.7$ |                    | $V_{CC} + 0.5$      | V       |
| $V_{OL}$       | Output LOW Voltage (SO)                          | $I_{OL} = 2mA @ V_{CC} = 2.7V$<br>$I_{OL} = 0.5mA @ V_{CC} = 1.8V$              |                     |                    | 0.4                 | V       |
| $V_{OH1}$      | Output HIGH Voltage (SO)                         | $V_{CC} > 3.3V$ , $I_{OH} = -1.0mA$   | $V_{CC} - 0.8$      |                    |                     | V       |
| $V_{OH2}$      | Output HIGH Voltage (SO)                         | $2V < V_{CC} \leq 3.3V$ , $I_{OH} = -0.4mA$                                     | $V_{CC} - 0.4$      |                    |                     | V       |
| $V_{OH3}$      | Output HIGH Voltage (SO)                         | $V_{CC} \leq 2V$ , $I_{OH} = -0.25mA$   | $V_{CC} - 0.2$      |                    |                     | V       |
| $V_{OLRS}$     | Output LOW Voltage ( $\overline{RESET}$ , RESET) | $I_{OL} = 1mA$  |                     |                    | 0.4                 | V       |

**Capacitance**  $T_A = +25^\circ C$ ,  $f = 1MHz$ ,  $V_{CC} = 5V$ 

| SYMBOL          | TEST  | CONDITIONS     | MAX | UNIT |
|-----------------|---|----------------|-----|------|
| $C_{OUT}^{(2)}$ | Output Capacitance (SO, $\overline{RESET}$ , RESET)             | $V_{OUT} = 0V$ | 8   | pF   |
| $C_{IN}^{(2)}$  | Input Capacitance (SCK, SI, $\overline{CS}$ , $\overline{WP}$ ) | $V_{IN} = 0V$  | 6   | pF   |

## NOTES:

- $V_{IL}$  min. and  $V_{IH}$  max. are for reference only and are not tested.
- This parameter is periodically sampled and not 100% tested.
- SCK frequency measured from  $V_{CC} \times 0.1/V_{CC} \times 0.9$

**Equivalent A.C. Load Circuit at 5V V<sub>CC</sub>****A.C. Test Conditions**

|                               |  |
|-------------------------------|--|
| Input pulse levels            | $V_{CC} \times 0.1$ to $V_{CC} \times 0.9$ |
| Input rise and fall times     | 10ns                                       |
| Input and output timing level | $V_{CC} \times 0.5$                        |

**AC Electrical Specifications** (Over recommended operating conditions, unless otherwise specified)

| SYMBOL                   | PARAMETER                     | 2.7V–5.5V |     | UNIT    |
|--------------------------|-------------------------------|-----------|-----|---------|
|                          |                               | MIN       | MAX |         |
| <b>DATA INPUT TIMING</b> |                               |           |     |         |
| $f_{SCK}$                | Clock Frequency               | 0         | 3.3 | MHz     |
| $t_{CYC}$                | Cycle Time                    | 300       |     | ns      |
| $t_{LEAD}$               | $\overline{CS}$ Lead Time     | 150       |     | ns      |
| $t_{LAG}$                | $\overline{CS}$ Lag Time      | 150       |     | ns      |
| $t_{WH}$                 | Clock HIGH Time               | 130       |     | ns      |
| $t_{WL}$                 | Clock LOW Time                | 130       |     | ns      |
| $t_{SU}$                 | Data Setup Time               | 30        |     | ns      |
| $t_H$                    | Data Hold Time                | 30        |     | ns      |
| $t_{RI}^{(4)}$           | Input Rise Time               |           | 2   | $\mu s$ |
| $t_{FI}^{(4)}$           | Input Fall Time               |           | 2   | $\mu s$ |
| $t_{CS}$                 | $\overline{CS}$ Deselect Time | 100       |     | ns      |
| $t_{WC}^{(5)}$           | Write Cycle Time              |           | 10  | ms      |

**Data Output Timing**

| SYMBOL         | PARAMETER                   | 2.7–5.5V |     | UNIT |
|----------------|-----------------------------|----------|-----|------|
|                |                             | MIN      | MAX |      |
| $f_{SCK}$      | Clock Frequency             | 0        | 3.3 | MHz  |
| $t_{DIS}$      | Output Disable Time         |          | 150 | ns   |
| $t_V$          | Output Valid from Clock Low |          | 120 | ns   |
| $t_{HO}$       | Output Hold Time            | 0        |     | ns   |
| $t_{RO}^{(4)}$ | Output Rise Time            |          | 50  | ns   |
| $t_{FO}^{(4)}$ | Output Fall Time            |          | 50  | ns   |

## NOTES:

- This parameter is periodically sampled and not 100% tested.
- $t_{WC}$  is the time from the rising edge of  $\overline{CS}$  after a valid write sequence has been sent to the end of the self-timed internal nonvolatile write cycle.

**Serial Output Timing**



**Serial Input Timing**



**Symbol Table**

| WAVEFORM | INPUTS                      | OUTPUTS                       |
|----------|-----------------------------|-------------------------------|
|          | Must be steady              | Will be steady                |
|          | May change from LOW to HIGH | Will change from LOW to HIGH  |
|          | May change from HIGH to LOW | Will change from HIGH to LOW  |
|          | Don't Care: Changes Allowed | Changing: State Not Known     |
|          | N/A                         | Center Line is High Impedance |

**Power-Up and Power-Down Timing**



**RESET Output Timing**

| SYMBOL                          | PARAMETER                              | MIN  | TYP  | MAX  | UNIT |
|---------------------------------|--|------|------|------|------|
| V <sub>TRIP</sub>               | Reset Trip Point Voltage, (-4.5A)      | 4.5  | 4.62 | 4.75 | V    |
|                                 | Reset Trip Point Voltage, (Blank)      | 4.25 | 4.38 | 4.5  |      |
|                                 | Reset Trip Point Voltage, (-2.7A)      | 2.85 | 2.92 | 3.0  |      |
|                                 | Reset Trip Point Voltage, (-2.7)       | 2.55 | 2.62 | 2.7  |      |
| t <sub>PURST</sub>              | Power-up Reset Time Out                | 100  | 200  | 400  | ms   |
| t <sub>RPD</sub> <sup>(6)</sup> | V <sub>CC</sub> Detect to Reset/Output |      |      | 500  | ns   |
| t <sub>F</sub> <sup>(6)</sup>   | V <sub>CC</sub> Fall Time              | 10   |      |      | µs   |
| t <sub>R</sub> <sup>(6)</sup>   | V <sub>CC</sub> Rise Time              | 0.1  |      |      | ns   |
| V <sub>RVALID</sub>             | Reset Valid V <sub>CC</sub>            | 1    |      |      | V    |

NOTE:

6. This parameter is periodically sampled and not 100% tested.

**CS/WDI vs. RESET/RESET Timing**



**RESET/RESET Output Timing**

| SYMBOL           | PARAMETER   | MIN | TYP | MAX | UNIT |
|------------------|---|-----|-----|-----|------|
| t <sub>WDO</sub> | Watchdog Time Out Period,<br>WD1 = 1, WD0 = 1 (default) |     | OFF |     |      |
|                  | WD1 = 1, WD0 = 0  | 100 | 200 | 300 | ms   |
|                  | WD1 = 0, WD0 = 1  | 450 | 600 | 800 | ms   |
|                  | WD1 = 0, WD0 = 0  | 1   | 1.4 | 2   | sec  |
| t <sub>CST</sub> | CS Pulse Width to Reset the Watchdog                    | 400 |     |     | ns   |
| t <sub>RST</sub> | Reset Time Out  | 100 | 200 | 400 | ms   |



***V<sub>TRIP</sub> Programming Timing Diagram***



***V<sub>TRIP</sub> Programming Parameters***

| PARAMETER         | DESCRIPTION   | MIN | MAX  | UNIT |
|-------------------|---|-----|------|------|
| $t_{VPS}$         | V <sub>TRIP</sub> Program Enable Voltage Setup time                                   | 1   |      | μs   |
| $t_{VPH}$         | V <sub>TRIP</sub> Program Enable Voltage Hold time                                    | 1   |      | μs   |
| $t_{PCS}$         | V <sub>TRIP</sub> Programming $\overline{CS}$ inactive time                           | 1   |      | μs   |
| $t_{TSU}$         | V <sub>TRIP</sub> Setup time  | 1   |      | μs   |
| $t_{THD}$         | V <sub>TRIP</sub> Hold (stable) time  | 10  |      | ms   |
| $t_{WC}$          | V <sub>TRIP</sub> Write Cycle Time  |     | 10   | ms   |
| $t_{VPO}$         | V <sub>TRIP</sub> Program Enable Voltage Off time (Between successive adjustments)    | 0   |      | μs   |
| $t_{RP}$          | V <sub>TRIP</sub> Program Recovery Period (Between successive adjustments)            | 10  |      | ms   |
| V <sub>P</sub>    | Programming Voltage   | 15  | 18   | V    |
| V <sub>TRAN</sub> | V <sub>TRIP</sub> Programmed Voltage Range  | 1.7 | 4.75 | V    |
| V <sub>tv</sub>   | V <sub>TRIP</sub> Program variation after programming (0-75°C). (Programmed at 25°C.) | -25 | +25  | mV   |

V<sub>TRIP</sub> programming parameters are periodically sampled and are not 100% tested.

## Revision History

The revision history provided is for informational purposes only and is believed to be accurate, but not warranted. Please go to the web to make sure that you have the latest revision.

| DATE               | REVISION | CHANGE  |
|--------------------|----------|---|
| September 23, 2015 | FN8126.3 | <ul style="list-style-type: none"> <li>- Updated Ordering Information Table on page 3.</li> <li>- Added Revision History.</li> <li>- Added About Intersil Verbiage.</li> <li>- Attached current POD.</li> </ul> |

## About Intersil

Intersil Corporation is a leading provider of innovative power management and precision analog solutions. The company's products address some of the largest markets within the industrial and infrastructure, mobile computing and high-end consumer markets.

For the most updated datasheet, application notes, related documentation and related parts, please see the respective product information page found at [www.intersil.com](http://www.intersil.com).

You may report errors or suggestions for improving this datasheet by visiting [www.intersil.com/ask](http://www.intersil.com/ask).

Reliability reports are also available from our website at [www.intersil.com/support](http://www.intersil.com/support).

© Copyright Intersil Americas LLC 2005-2015 All Rights Reserved.  
All trademarks and registered trademarks are the property of their respective owners.

For additional products, see [www.intersil.com/en/products.html](http://www.intersil.com/en/products.html)

Intersil products are manufactured, assembled and tested utilizing ISO9001 quality systems as noted in the quality certifications found at [www.intersil.com/en/support/qualandreliability.html](http://www.intersil.com/en/support/qualandreliability.html)

*Intersil products are sold by description only. Intersil may modify the circuit design and/or specifications of products at any time without notice, provided that such modification does not, in Intersil's sole judgment, affect the form, fit or function of the product. Accordingly, the reader is cautioned to verify that datasheets are current before placing orders. Information furnished by Intersil is believed to be accurate and reliable. However, no responsibility is assumed by Intersil or its subsidiaries for its use; nor for any infringements of patents or other rights of third parties which may result from its use. No license is granted by implication or otherwise under any patent or patent rights of Intersil or its subsidiaries.*

For information regarding Intersil Corporation and its products, see [www.intersil.com](http://www.intersil.com)

### Plastic Dual-In-Line Packages (PDIP)



#### MDP0031

#### PLASTIC DUAL-IN-LINE PACKAGE

| SYMBOL | INCHES |        |        |        |        | TOLERANCE     | NOTES |
|--------|--------|--------|--------|--------|--------|---------------|-------|
|        | PDIP8  | PDIP14 | PDIP16 | PDIP18 | PDIP20 |               |       |
| A      | 0.210  | 0.210  | 0.210  | 0.210  | 0.210  | MAX           |       |
| A1     | 0.015  | 0.015  | 0.015  | 0.015  | 0.015  | MIN           |       |
| A2     | 0.130  | 0.130  | 0.130  | 0.130  | 0.130  | ±0.005        |       |
| b      | 0.018  | 0.018  | 0.018  | 0.018  | 0.018  | ±0.002        |       |
| b2     | 0.060  | 0.060  | 0.060  | 0.060  | 0.060  | +0.010/-0.015 |       |
| c      | 0.010  | 0.010  | 0.010  | 0.010  | 0.010  | +0.004/-0.002 |       |
| D      | 0.375  | 0.750  | 0.750  | 0.890  | 1.020  | ±0.010        | 1     |
| E      | 0.310  | 0.310  | 0.310  | 0.310  | 0.310  | +0.015/-0.010 |       |
| E1     | 0.250  | 0.250  | 0.250  | 0.250  | 0.250  | ±0.005        | 2     |
| e      | 0.100  | 0.100  | 0.100  | 0.100  | 0.100  | Basic         |       |
| eA     | 0.300  | 0.300  | 0.300  | 0.300  | 0.300  | Basic         |       |
| eB     | 0.345  | 0.345  | 0.345  | 0.345  | 0.345  | ±0.025        |       |
| L      | 0.125  | 0.125  | 0.125  | 0.125  | 0.125  | ±0.010        |       |
| N      | 8      | 14     | 16     | 18     | 20     | Reference     |       |

Rev. C 2/07

NOTES:

1. Plastic or metal protrusions of 0.010" maximum per side are not included.
2. Plastic interlead protrusions of 0.010" maximum per side are not included.
3. Dimensions E and eA are measured with the leads constrained perpendicular to the seating plane.
4. Dimension eB is measured with the lead tips unconstrained.
5. 8 and 16 lead packages have half end-leads as shown.

# Package Outline Drawing

## M8.15

8 LEAD NARROW BODY SMALL OUTLINE PLASTIC PACKAGE

Rev 4, 1/12

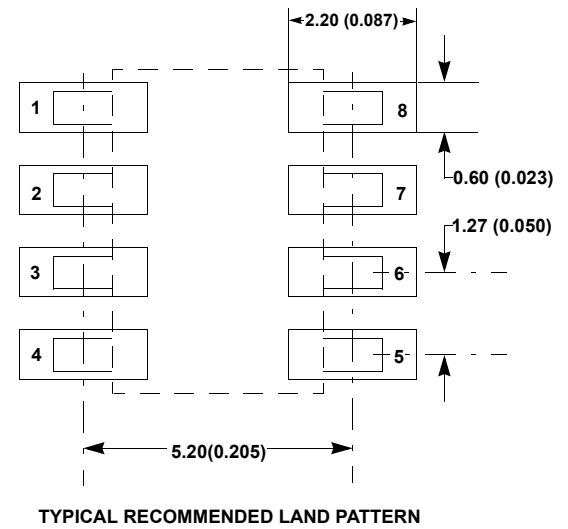

**NOTES:**

6. Dimensioning and tolerancing per ANSI Y14.5M-1994.
7. Package length does not include mold flash, protrusions or gate burrs. Mold flash, protrusion and gate burrs shall not exceed 0.15mm (0.006 inch) per side.
8. Package width does not include interlead flash or protrusions. Interlead flash and protrusions shall not exceed 0.25mm (0.010 inch) per side.
9. The chamfer on the body is optional. If it is not present, a visual index feature must be located within the crosshatched area.
10. Terminal numbers are shown for reference only.
11. The lead width as measured 0.36mm (0.014 inch) or greater above the seating plane, shall not exceed a maximum value of 0.61mm (0.024 inch).
12. Controlling dimension: MILLIMETER. Converted inch dimensions are not necessarily exact.
13. This outline conforms to JEDEC publication MS-012-AA ISSUE C.

# Package Outline Drawing

## M8.118

8 LEAD MINI SMALL OUTLINE PLASTIC PACKAGE

Rev 4, 7/11

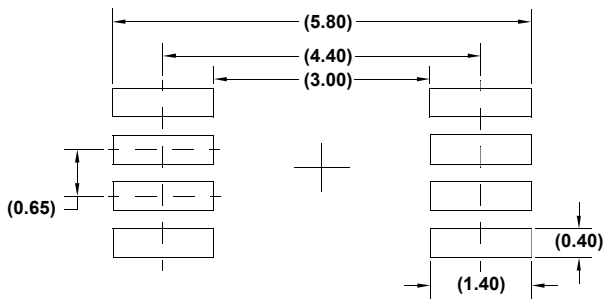
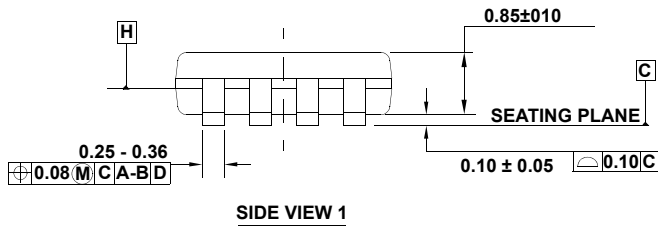
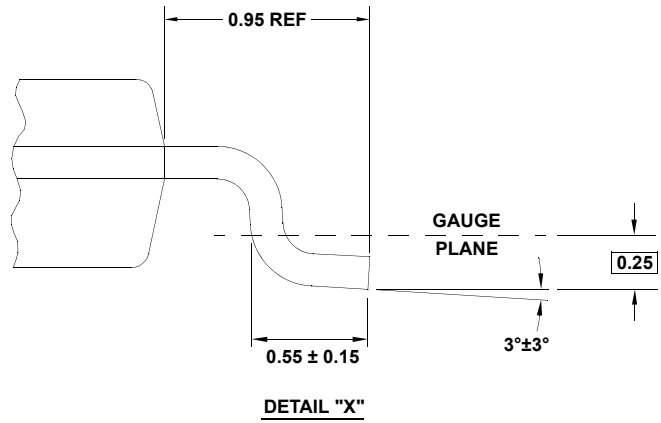
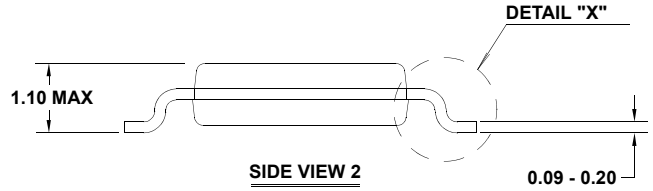

**NOTES:**

1. Dimensions are in millimeters.
2. Dimensioning and tolerancing conform to JEDEC MO-187-AA and AMSEY14.5m-1994.
3. Plastic or metal protrusions of 0.15mm max per side are not included.
4. Plastic interlead protrusions of 0.15mm max per side are not included.
5. Dimensions are measured at Datum Plane "H".
6. Dimensions in ( ) are for reference only.



Компания «ЭлектроПласт» предлагает заключение долгосрочных отношений при поставках импортных электронных компонентов на взаимовыгодных условиях!

Наши преимущества:

- Оперативные поставки широкого спектра электронных компонентов отечественного и импортного производства напрямую от производителей и с крупнейших мировых складов;
- Поставка более 17-ти миллионов наименований электронных компонентов;
- Поставка сложных, дефицитных, либо снятых с производства позиций;
- Оперативные сроки поставки под заказ (от 5 рабочих дней);
- Экспресс доставка в любую точку России;
- Техническая поддержка проекта, помощь в подборе аналогов, поставка прототипов;
- Система менеджмента качества сертифицирована по Международному стандарту ISO 9001;
- Лицензия ФСБ на осуществление работ с использованием сведений, составляющих государственную тайну;
- Поставка специализированных компонентов (Xilinx, Altera, Analog Devices, Intersil, Interpoint, Microsemi, Aeroflex, Peregrine, Syfer, Eurofarad, Texas Instrument, Miteq, Cobham, E2V, MA-COM, Hittite, Mini-Circuits, General Dynamics и др.);

Помимо этого, одним из направлений компании «ЭлектроПласт» является направление «Источники питания». Мы предлагаем Вам помощь Конструкторского отдела:

- Подбор оптимального решения, техническое обоснование при выборе компонента;
- Подбор аналогов;
- Консультации по применению компонента;
- Поставка образцов и прототипов;
- Техническая поддержка проекта;
- Защита от снятия компонента с производства.



#### Как с нами связаться

**Телефон:** 8 (812) 309 58 32 (многоканальный)

**Факс:** 8 (812) 320-02-42

**Электронная почта:** [org@eplast1.ru](mailto:org@eplast1.ru)

**Адрес:** 198099, г. Санкт-Петербург, ул. Калинина, дом 2, корпус 4, литера А.