

Ordering Table — Standard Toggle Switches

HOW TO ORDER YOUR DESIGN (Bold Face Type indicates items normally in Distributor Stock)

Following the table from left to right, the designer is able to specify the options wanted. The options are described and illustrated on pages 24-31. Refer to page 57 for mounting hardware.

To determine a part number select the options desired and fill in the boxes in the selection guides illustrated below.

Toggle Switch Selection Guide



Series	Poles and Throw		Circuits ¹⁰				Lever Options and Finishes				Bushing Options		Terminal Options ⁷		Contact Material		Other Option	
	No.	Code	Keyway		Code	Type	Code	Finish	Code	Type	Code	Type	Code	Type	Code	Type	Code	
A	SPDT	1			POS. "C"	Lever Lock K Bushing Only	K1	Bright Chrome ¹⁴	1	Splashproof Lever ⁹ & Bushing Seal	CW	Right Angle PC		Gold/Nickel/Brass	B	Epoxy Sealed ⁷		
	DPDT	2	ON	OFF	ON	.840 Bat	L0	Stain Chrome	2	Splashproof ⁹	CX	Vertical PC .100 Spacing	A	Gold/Nickel/Silver	G	Terminals		
						.640 Bat	L1	Black ¹	3	Lever Seal Only		.150 Spacing	AV	Coin Silver	Q	Anti-Rotation	P	
	3PDT	3	ON	NONE	ON	.550 Bat	L2			.280 Threaded	D	Vertical PC .150 Spacing	AV2	¹⁵	K	Anti-Jam		
						Long Mod Cap	L3	Black Nylon ⁸	4	²		Printed Circuit Terminals	C	¹⁵	L	Bushing ⁴		
	4PDT	4	ON	NONE	ON*	Short Mod Cap	L4	Red Nylon ⁸	5	.280 Smooth ²	D9	Right Angle ⁹ Same Throw	R	¹⁵	M			
			ON*	OFF	ON*	.200 Bat	M	White Nylon ⁸	6	With Shoulder	H3	Right Angle ⁹ Opposite Throw	R2					
			ON	OFF	ON*	.450 Flat	P1			.350 Keyway With Shoulder	K	PC & Support ⁶	V30					
			ON	ON	ON	.250 Flat	P3			Locking K1 Lever Only	T	PC & Support ⁶	V40					
			ON	ON	ON*	.410 Bat	P4			15/32 Dia. ¹²	TW	PC & Support ⁶	V60					
			NONE	ON	ON*	.468 Large ¹³	S			Splashproof Lever ¹² 15/32 & Panel Seal	TX	PC & Support ⁶	V70					
			ON*	ON	ON*	.687 Large ¹³	T1			15/32 Splashproof ¹² Lever Seal Only	Y	PC & Support ⁶	W					
			NONE	ON	ON		T			.350 Threaded	Y5	.750 Wire Wrap	W1					
										.437 Threaded (With P3 Only)	Y9	.964 Wire Wrap	W3					
										.350 Smooth		1.062 Wire Wrap	W4					
												Solder Lugs	Z					
												Quick Connect	Z3					

*Momentary Contact

- ¹ Available on S, M and P3 only.
- ² Add .070 to lever length when using these bushings.
- ³ Available with S, M, L0, L1, L2, L3, L4 lever options. Consult factory for availability.
- ⁴ Standard on P1, P3, P4 and K1 lever options. Available on all other levers except T & T1.
- ⁵ These circuits are **NOT** available with the following 3 and 4 pole options: A, AV, AV2, V30, V40, V60 and V70.
- ⁶ 1 and 2 pole only.
- ⁷ Epoxy seal standard on all terminal options.

- ⁸ Available only with L3 and L4 levers.
- ⁹ Available in 1 pole only.
- ¹⁰ See page 58 for construction detail, wiring and electrical diagrams.
- ¹¹ 1, 2 and 3 pole only.
- ¹² Available on T or T1 lever options only.
- ¹³ Available on T, TW, and TX bushing options. (Bright chrome only.)
- ¹⁴ Not available on K1 lever.
- ¹⁵ Same as B, G and Q respectively except terminals brass with tin nickel alloy over nickel plate. Consult plant for availability.

EXAMPLES:

A232L01YW1B = DPDT toggle switch with an ON-ON-ON circuit, .840" long lever in a bright chrome finish, .350 threaded bushing, .964" long wire wrap terminals, gold/brass contacts and epoxy sealed terminals.

SPECIFICATIONS:

Contact Ratings —

Letter codes G and Q — 6 amp at 125 VAC, 3 amp @ 250 VAC (U.L. recognized, CSA certified) or 6 amp at 28 VDC resistive.
Letter codes B and G — 0.5. volt-amp (VA) maximum @ 28 V maximum (AC or DC).

Life Under Load — 60,000 make-and-break cycles — resistive load only.

Initial Contact Resistance — 10 milliohms maximum 3 VDC, 100 ma for both silver and gold plated contacts.

Insulation Resistance — 1 & 2 pole —1,000 megohms, min.
3 & 4 pole —1,000 megohms, min.

Dielectric Strength — 1,000 volts rms at sea level.

Bushing Strength — 12 pound-inches without physical damage to switch.

Weight (including hardware) — SP 0.19 oz.; DP 0.23 oz.; 3-pole 0.28 oz.; 4-pole 0.32 oz.

MATERIALS:

Base (body) — 1- and 2-pole —Diallyl Phthalate (DAP).
3- and 4-pole — high strength phenolic.

Lever (toggle) — Brass, chrome plated.

Flat Lever — Brass, satin chrome finish.

Locking lever cap — Anodized aluminum.

Bushing — Brass, nickel plated.

Clamp (frame) — Stainless steel.

Support brackets — Steel, tin plated.

Switching Contacts and Rockers —

Letter Code B — gold/nickel/brass

Letter Code G — gold/nickel/silver

Letter Code Q — Coin silver

Center Terminal

Letter Codes B, G — Gold flash/nickel/brass

Letter Code Q — Silver plated brass.

Hardware — See page 55-57.

Toggle Switches — Base Dimensions and Lever Options

APPROXIMATE BASE DIMENSIONS



TOGGLE LEVER OPTIONS



Toggle Lever Options — Contd.

<p>M Short (.200")</p>	<p>P1 Flatted (.840")</p>	<p>P3 Flatted (.448")</p>	<p>P4 Flatted (.250")</p>
<p>S Std. Bat (.410")</p>	<p>T Large Toggle</p>	<p>T1 Large Toggle</p>	

BUSHING OPTIONS

<p>CW Splashproof Sealed Lever and Panel Seal</p> <p>CW = Flatted bushing</p>	<p>D D9 Threaded Smooth (No Keyway)</p>	
<p>H High Torque Flatted with Shoulder</p>	<p>H3 High Torque</p>	<p>P Anti-Rotation</p>
<p>TW Splashproof Sealed Lever and Panel Seal</p>	<p>OX Y Y9 Threaded with Lever Seal Threaded Smooth (No Keyway)</p>	<p>Y5 Long Bushing (.437")</p>

K Refer to K1 lever drawing for dimensions.

T&TX Refer to T or T1 lever drawing for dimensions.

Note: For hardware refer to pages 55-57.



TERMINATION/MOUNTING OPTIONS

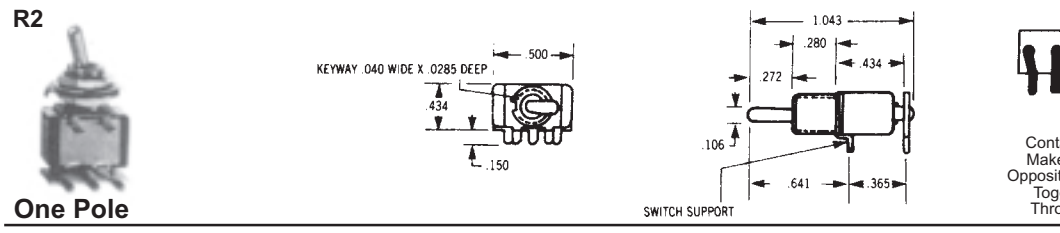
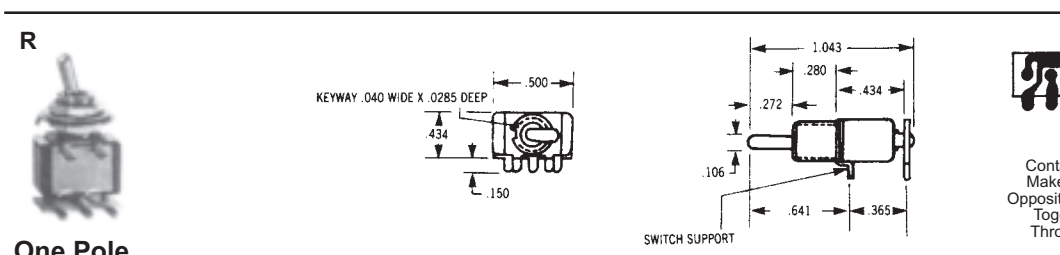
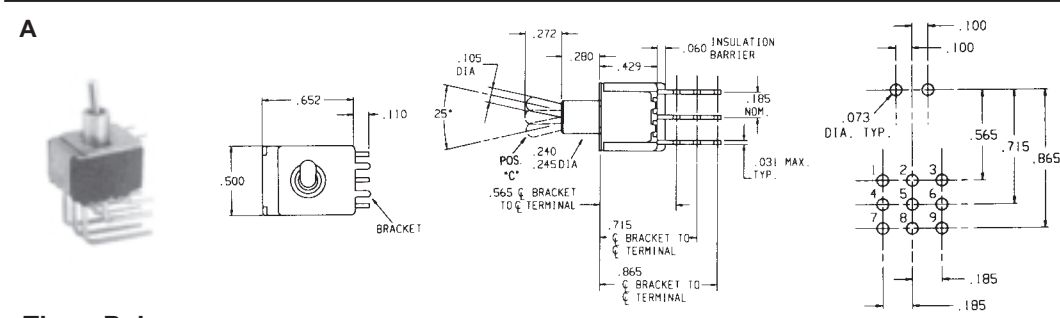
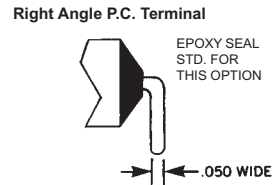
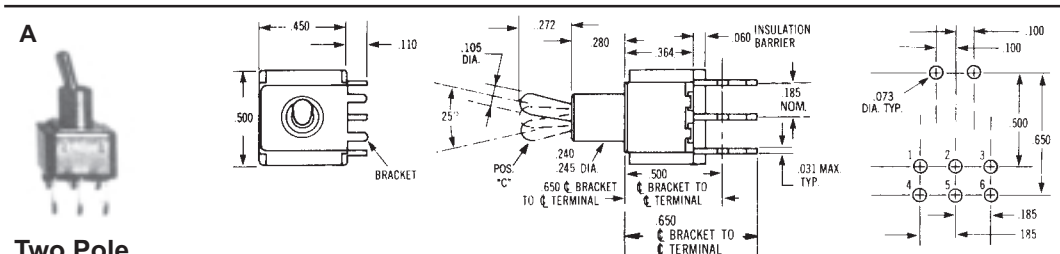

Termination/Mounting Options

AV1	w/.100" terminal spacing
AV2	w/.150" terminal spacing (pictured below)



ONE POLE Epoxy sealed P.C. terminals are supplied as standard for these options.

AV1	w/.100" terminal spacing
AV2	w/.150" terminal spacing (pictured below)



TWO POLE Epoxy sealed P.C. terminals are supplied as standard for these options.

AV	w/.100" terminal spacing
AV2	w/.150" terminal spacing (pictured below)



THREE POLE Epoxy sealed P.C. terminals are supplied as standard for these options.

AV	w/.100" terminal spacing
AV2	w/.150" terminal spacing (pictured below)



FOUR POLE Epoxy sealed P.C. terminals are supplied as standard for these options.

V30

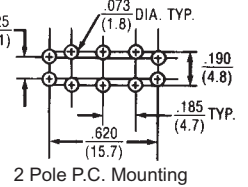
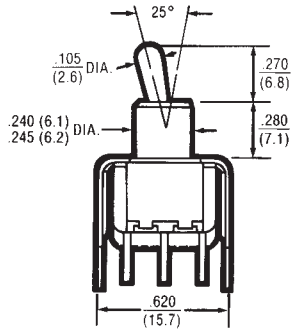

EPOXY SEALED P.C. TERMINALS ARE SUPPLIED AS STANDARD FOR THESE OPTIONS

V40

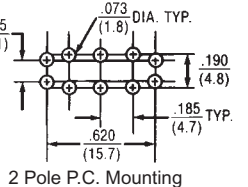
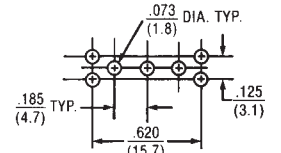
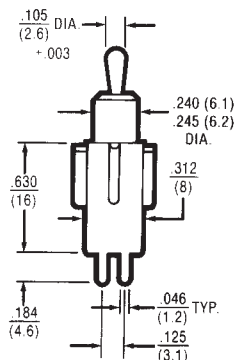
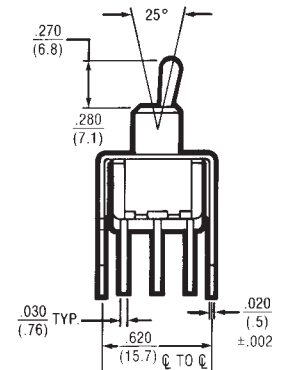
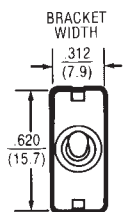
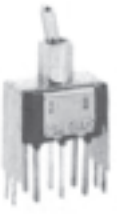
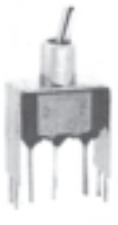

EPOXY SEALED P.C. TERMINALS ARE SUPPLIED AS STANDARD FOR THESE OPTIONS

V60

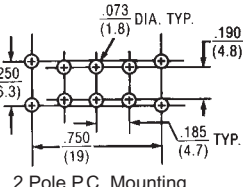
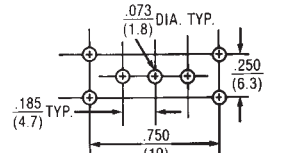
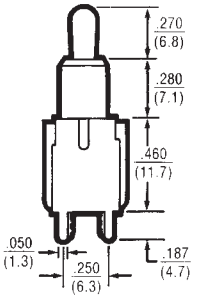
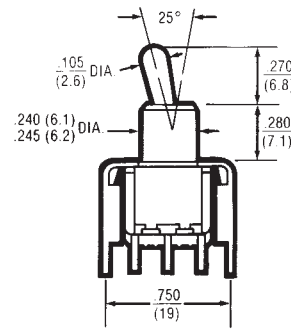
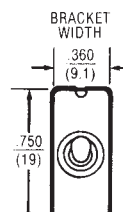

EPOXY SEALED P.C. TERMINALS ARE SUPPLIED AS STANDARD FOR THESE OPTIONS

V70

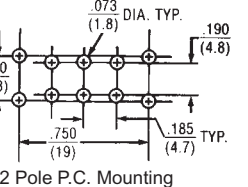
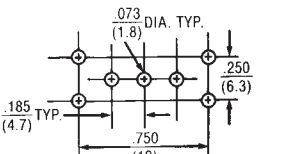
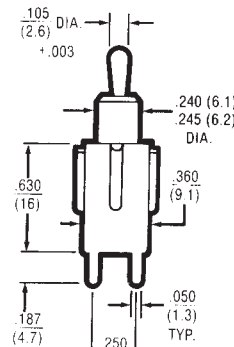
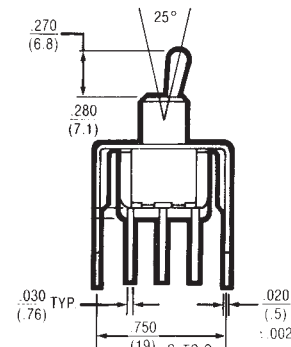
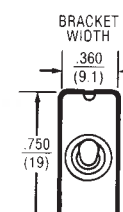

EPOXY SEALED P.C. TERMINALS ARE SUPPLIED AS STANDARD FOR THESE OPTIONS



Компания «ЭлектроПласт» предлагает заключение долгосрочных отношений при поставках импортных электронных компонентов на взаимовыгодных условиях!

Наши преимущества:

- Оперативные поставки широкого спектра электронных компонентов отечественного и импортного производства напрямую от производителей и с крупнейших мировых складов;
- Поставка более 17-ти миллионов наименований электронных компонентов;
- Поставка сложных, дефицитных, либо снятых с производства позиций;
- Оперативные сроки поставки под заказ (от 5 рабочих дней);
- Экспресс доставка в любую точку России;
- Техническая поддержка проекта, помощь в подборе аналогов, поставка прототипов;
- Система менеджмента качества сертифицирована по Международному стандарту ISO 9001;
- Лицензия ФСБ на осуществление работ с использованием сведений, составляющих государственную тайну;
- Поставка специализированных компонентов (Xilinx, Altera, Analog Devices, Intersil, Interpoint, Microsemi, Aeroflex, Peregrine, Syfer, Eurofarad, Texas Instrument, Miteq, Cobham, E2V, MA-COM, Hittite, Mini-Circuits, General Dynamics и др.);

Помимо этого, одним из направлений компании «ЭлектроПласт» является направление «Источники питания». Мы предлагаем Вам помощь Конструкторского отдела:

- Подбор оптимального решения, техническое обоснование при выборе компонента;
- Подбор аналогов;
- Консультации по применению компонента;
- Поставка образцов и прототипов;
- Техническая поддержка проекта;
- Защита от снятия компонента с производства.



Как с нами связаться

Телефон: 8 (812) 309 58 32 (многоканальный)

Факс: 8 (812) 320-02-42

Электронная почта: org@eplast1.ru

Адрес: 198099, г. Санкт-Петербург, ул. Калинина, дом 2, корпус 4, литера А.