









Symbols

International electrical symbols used on the Product and in this document are explained below.

Symbol	Description
	WARNING - RISK OF DANGER. Consult user documentation.
	WARNING. HAZARDOUS VOLTAGE. Risk of electric shock.
	DC (Direct Current)
	Double Insulated
	Conforms to European Union directives.
	Energy Efficiency Level VI
	This product complies with the WEEE Directive marking requirements. The affixed label indicates that you must not discard this electrical/electronic product in domestic household waste. Product Category: With reference to the equipment types in the WEEE Directive Annex I, this product is classed as category 9 "Monitoring and Control Instrumentation" product. Do not dispose of this product as unsorted municipal waste.
	Conforms to relevant South Korean EMC Standards.
	Certified by ETL Intertek to North American safety standards.

LIMITED WARRANTY AND LIMITATION OF LIABILITY

This Fluke product will be free from defects in material and workmanship for one year from the date of purchase. This warranty does not cover fuses, disposable batteries, or damage from accident, neglect, misuse, alteration, contamination, or abnormal conditions of operation or handling. Resellers are not authorized to extend any other warranty on Fluke's behalf. To obtain service during the warranty period, contact your nearest Fluke authorized service center to obtain return authorization information, then send the product to that Service Center with a description of the problem.

THIS WARRANTY IS YOUR ONLY REMEDY. NO OTHER WARRANTIES, SUCH AS FITNESS FOR A PARTICULAR PURPOSE, ARE EXPRESSED OR IMPLIED. FLUKE IS NOT LIABLE FOR ANY SPECIAL, INDIRECT, INCIDENTAL OR CONSEQUENTIAL DAMAGES OR LOSSES, ARISING FROM ANY CAUSE OR THEORY. Since some states or countries do not allow the exclusion or limitation of an implied warranty or of incidental or consequential damages, this limitation of liability may not apply to you.

Fluke Corporation
P.O. Box 9090
Everett, WA 98206-9090
U.S.A.

Fluke Europe B.V
P.O. Box 1186
5602 BD
Eindhoven
The Netherlands

BC430/830

Universal Mains-Power Adapter

Instruction Sheet

Introduction

The BC430/830 is a universal mains-power adapter (the Adapter or Product) for measurement, control, and laboratory equipment. The Adapter is intended for operating and charging the Fluke 430-Series Power Quality Analyzers and 120B-Series ScopeMeter Test Tool. The Adapter is based on the switched-mode concept for high efficiency and low stand-by power consumption, and complies with level-VI requirements. It operates in a wide range of input voltages from 100 Vac up to 240 Vac nominal.

A universal set of mains cords is included to make the Adapter suitable for most types of mains outlet.

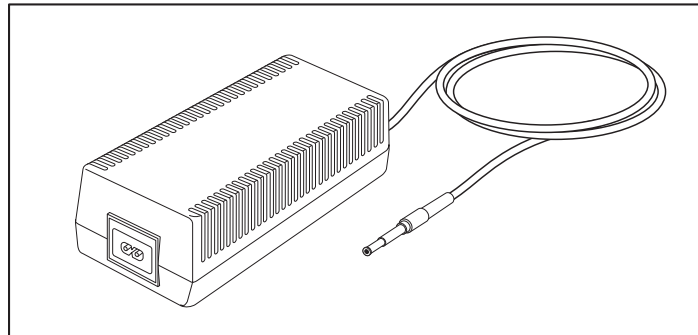

How to Contact Fluke

To contact Fluke, call one of the following telephone numbers:

- Technical Support USA: 1-800-44-FLUKE (1-800-443-5853)
- Calibration/Repair USA: 1-888-99-FLUKE (1-888-993-5853)
- Canada: 1-800-36-FLUKE (1-800-363-5853)
- Europe: +31 402-675-200
- Japan: +81-3-6714-3114
- Singapore: +65-6799-5566
- Anywhere in the world: +1-425-446-5500

Or, visit Fluke's website at www.fluke.com.

To register your product, visit <http://register.fluke.com>.

To view, print, or download the latest manual supplement, visit <http://us.fluke.com/user/support/manuals>.



Safety Information

A **Warning** identifies conditions and procedures that are dangerous to the user.

Warning

To prevent electrical shock, fire, or personal injury:

- Read these instructions carefully before using the Product.
- Use the Product only with Fluke test tools that have the type number 'BC430' specified for charge and operation.
- Use this Product only as specified.
- Do not open the Product, it has no user-serviceable parts inside.
- Do not use the Product around explosive gas, vapor, or in damp or wet environments.
- Use this Product indoors only.
- Examine the case before you use the Product. Look for cracks or missing plastic. Carefully look at the cable jacket and insulation around the terminals.
- Use only the mains power cord and connector approved for the voltage and plug configuration in your country and rated for the Product.
- Replace the mains power cord if the insulation is damaged or if the insulation shows signs of wear.
- Do not use the Product if it is altered or damaged.

Unpack

The Adapter includes these items:

- BC430/830 Switch Mode Power Adapter (main unit) with dc cable
- Universal set of 2-wire mains cords with male and female connector

At delivery of the Adapter, make sure that the shipment is complete and all items are undamaged. Contact your supplier if you see any damage.

Operation

The power cord connects the Adapter to the mains system. Do not block access to the power cord and power plug, these must remain accessible to the user at all times.

The Adapter is not equipped with a power switch. Disconnect the mains plug from the mains system when not in use.

In case the Adapter is damaged or any damage is suspected, disconnect from the mains system and have qualified service personnel inspect the Adapter before reconnecting to the mains system again.

To use:

1. Connect the mains cord to the Adapter.
2. Connect the power plug to the mains system.
3. Connect the dc plug to the test tool.

For continuous operation and recording with the test tool, keep the power adapter connected.

The Adapter operates and charges the test tool from local line voltage. Any power supply connected to the test tool introduces a certain capacitive coupling between the test tool and ground through the power supply circuitry. This capacitive coupling can affect test tool measurements. The Adapter is equipped with dedicated decoupling networks to reduce possible effects of such capacitive coupling during measurements.

For an optimal decoupling from ground, especially to make low-level measurements, Fluke recommends that you work in battery-operated mode without any power adapter connected. See the User Manual for the test tool to find complete safety information before making any measurements.

Note

Always fully charge the test tool battery before storage.

Specifications

Input

Nominal input voltage	100 Vac to 240 Vac, $\pm 10\%$
Input current	0.35 A at max. load
Nominal input frequency	50/60 Hz $\pm 10\%$
Mains inlet	IEC 60320-1 type C8
Input power, no load	<0.1 W (@ 115 / 230 Vac)

Output

Output voltage	18 Vdc $\pm 5\%$
Output current	0 mA to 840 mA
Output cable length	2 m (6.5 ft)
Output connector	5 mm outer diameter, per DIN45232
Output polarity	Inner contact negative, outer contact positive

Physical characteristics

Dimensions of main unit	79 mm x 149 mm x 49 mm
Housing material	Heat resistant ABS
Color (housing and cable)	Black
Weight	0.35 kg
Ingress Protection	IEC 60529, IP40

Environmental

Operating temperature	0 °C to 50 °C (32 °F to 122 °F), up to 90 % rel. humidity, no condensation
Storage temperature	-40 °C to +70 °C, 10 to 95 % rel. humidity
Max. altitude	2000 m (6562 ft) above sea-level

Included accessories

Power cord	Universal set of 2-wire cords
Mains cord length	1.8 m (6 ft), male to female
Power plug adapters	US-style, UK-style, European, Japanese, Chinese/Australian, Brazilian

Safety

IEC 61010-1, IEC 61010-2-030: CAT IV 600 V, Pollution Degree 2
--

Electromagnetic

Compatibility (EMC)

IEC 61326-1: Industrial Electromagnetic Environment
CISPR 11: Group 1, Class A

Group 1: Equipment has intentionally generated and/or use conductively coupled radio-frequency energy which is necessary for the internal functioning of the equipment itself.

Class A: Equipment is suitable for use in all establishments other than domestic and those directly connected to a low voltage power supply network which supplies buildings used for domestic purposes. There may be potential difficulties in ensuring electromagnetic compatibility in other environments, due to conducted and radiated disturbances.

Korea (KCC)

Class A Equipment (Industrial Broadcasting & Communication Equipment)

Class A: Equipment meets requirements for industrial electromagnetic wave equipment and the seller or user should take notice of it. This equipment is intended for use in business environments and not to be used in homes.



Компания «ЭлектроПласт» предлагает заключение долгосрочных отношений при поставках импортных электронных компонентов на взаимовыгодных условиях!

Наши преимущества:

- Оперативные поставки широкого спектра электронных компонентов отечественного и импортного производства напрямую от производителей и с крупнейших мировых складов;
- Поставка более 17-ти миллионов наименований электронных компонентов;
- Поставка сложных, дефицитных, либо снятых с производства позиций;
- Оперативные сроки поставки под заказ (от 5 рабочих дней);
- Экспресс доставка в любую точку России;
- Техническая поддержка проекта, помощь в подборе аналогов, поставка прототипов;
- Система менеджмента качества сертифицирована по Международному стандарту ISO 9001;
- Лицензия ФСБ на осуществление работ с использованием сведений, составляющих государственную тайну;
- Поставка специализированных компонентов (Xilinx, Altera, Analog Devices, Intersil, Interpoint, Microsemi, Aeroflex, Peregrine, Syfer, Eurofarad, Texas Instrument, Miteq, Cobham, E2V, MA-COM, Hittite, Mini-Circuits, General Dynamics и др.);

Помимо этого, одним из направлений компании «ЭлектроПласт» является направление «Источники питания». Мы предлагаем Вам помощь Конструкторского отдела:

- Подбор оптимального решения, техническое обоснование при выборе компонента;
- Подбор аналогов;
- Консультации по применению компонента;
- Поставка образцов и прототипов;
- Техническая поддержка проекта;
- Защита от снятия компонента с производства.



Как с нами связаться

Телефон: 8 (812) 309 58 32 (многоканальный)

Факс: 8 (812) 320-02-42

Электронная почта: org@eplast1.ru

Адрес: 198099, г. Санкт-Петербург, ул. Калинина, дом 2, корпус 4, литера А.