

Compensated High Current Choke, 1-phase



See below:
[Approvals and Compliances](#)

Description

- Current compensated choke
- 1-phase choke
- THT-terminals
- Flange for mounting onto printed circuit board
- Fully potted resin

Applications

- Placed in front of frequency converter
- Stepper motor drives
- UPS-systems
- Inverter

References

We recommend for new applications [DKIH-1](#)
 Last order date: 15.12.2018

Weblinks

[pdf data sheet](#), [html datasheet](#), [General Product Information](#), [Approvals](#), [Distributor-Stock-Check](#), [Detailed request for product](#)

Technical Data

Rated voltage	up to 540VAC up to 760VDC	Test Voltage	2.5kV, 50Hz, 2 sec, winding to winding
Rated Current	10 - 20A @ Ta 40 °C	Isolation Voltage	2.5kV eff., 50Hz, 2 sec, winding to ambient
Rated inductance	1.1 - 12mH, Tol. -30% +50%	Climatic Category	25/100/21 acc. to IEC 60068-1
Power Operating Frequency	50 - 400Hz	Allowable Operation Temp.	-25°C to 100°C
Terminal Type	THT		
Weight	145 - 525g		
Material: Housing	UL 94V-0		
Sealing Compound	UL 94V-0		

Approvals and Compliances

Detailed information on product approvals, code requirements, usage instructions and detailed test conditions can be looked up in [Details about Approvals](#)

SCHURTER products are designed for use in industrial environments. They have approvals from independent testing bodies according to national and international standards. Products with specific characteristics and requirements such as required in the automotive sector according to IATF 16949, medical technology according to ISO 13485 or in the aerospace industry can be offered exclusively with customer-specific, individual agreements by SCHURTER.

Approvals

The approval mark is used by the testing authorities to certify compliance with the safety requirements placed on electronic products.

Approval Reference Type: DKIL

Approval Logo	Certificates	Certification Body	Description
	UL Approvals	UL	UL File Number:





Application standards

Application standards where the product can be used

Organization	Design	Standard	Description
	Designed for applications acc.	IEC/UL 62368-1	IEC 62368-1 includes the basic requirements for safety of audio, video, information technology and office equipment.

Compliances

The product complies with following Guide Lines

Identification	Details	Initiator	Description
	CE declaration of conformity	SCHURTER AG	The CE marking declares that the product complies with the applicable requirements laid down in the harmonisation of Community legislation on its affixing in accordance with EU Regulation 765/2008.
	RoHS	SCHURTER AG	Directive RoHS 2011/65/EU, Amendment (EU) 2015/863
	China RoHS	SCHURTER AG	The law SJ / T 11363-2006 (China RoHS) has been in force since 1 March 2007. It is similar to the EU directive RoHS.
	REACH	SCHURTER AG	On 1 June 2007, Regulation (EC) No 1907/2006 on the Registration, Evaluation, Authorization and Restriction of Chemicals 1 (abbreviated as "REACH") entered into force.

Dimension [mm]

Case 31-2P

Case 46-2P

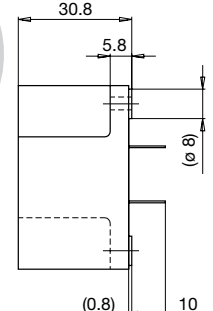
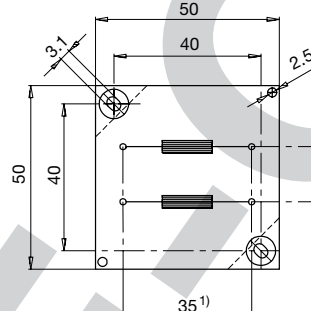
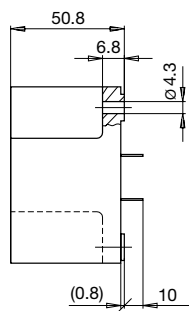
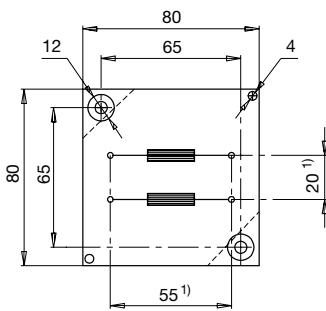

1) Spacing given at pin base

Impedance curves

DKIL-0231-xxxx

DKIL-0246-xxxx

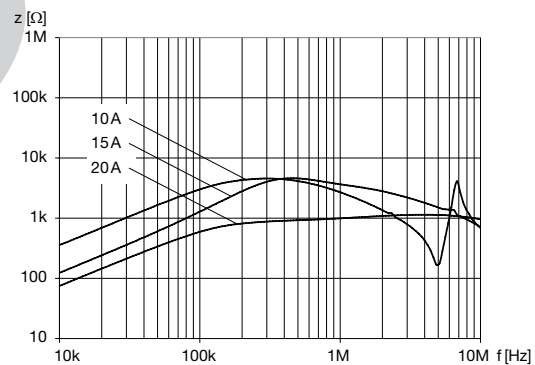
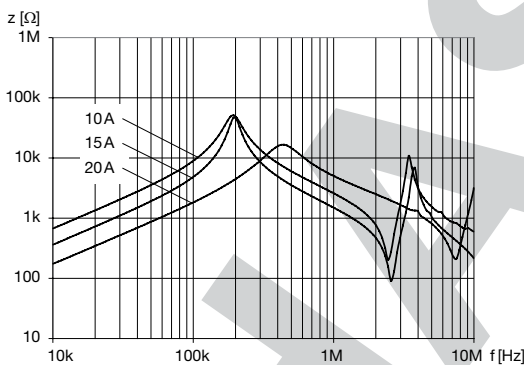

All Variants

I_n [A]	L_n [mH]	R_{cu} [mΩ]	Tripped Power Dissipation [W]	f_{RES} [MHz]	Copper ϕ [mm]	Weight [g]	Housings	Packing unit [pcs.]	Order Number
10	12	40	8	0.15	1.25	477 g	31-2P	2	DKIL-0231-1012
15	5	17	7.6	0.33	1.6	525 g	31-2P	2	DKIL-0231-1505
20	3	10	8	0.55	1.8	506 g	31-2P	2	DKIL-0231-2003
10	5	18	3.6	0.35	1.25	145 g	46-2P	10	DKIL-0246-1005
15	2	8	3.6	0.6	1.6	145 g	46-2P	10	DKIL-0246-1502
20	1.1	6	4.8	2.5	1.8	145 g	46-2P	10	DKIL-0246-2001

Availability for all products can be searched real-time: <https://www.schurter.com/en/Stock-Check/Stock-Check-SCHURTER>



Компания «ЭлектроПласт» предлагает заключение долгосрочных отношений при поставках импортных электронных компонентов на взаимовыгодных условиях!

Наши преимущества:

- Оперативные поставки широкого спектра электронных компонентов отечественного и импортного производства напрямую от производителей и с крупнейших мировых складов;
- Поставка более 17-ти миллионов наименований электронных компонентов;
- Поставка сложных, дефицитных, либо снятых с производства позиций;
- Оперативные сроки поставки под заказ (от 5 рабочих дней);
- Экспресс доставка в любую точку России;
- Техническая поддержка проекта, помощь в подборе аналогов, поставка прототипов;
- Система менеджмента качества сертифицирована по Международному стандарту ISO 9001;
- Лицензия ФСБ на осуществление работ с использованием сведений, составляющих государственную тайну;
- Поставка специализированных компонентов (Xilinx, Altera, Analog Devices, Intersil, Interpoint, Microsemi, Aeroflex, Peregrine, Syfer, Eurofarad, Texas Instrument, Miteq, Cobham, E2V, MA-COM, Hittite, Mini-Circuits, General Dynamics и др.);

Помимо этого, одним из направлений компании «ЭлектроПласт» является направление «Источники питания». Мы предлагаем Вам помощь Конструкторского отдела:

- Подбор оптимального решения, техническое обоснование при выборе компонента;
- Подбор аналогов;
- Консультации по применению компонента;
- Поставка образцов и прототипов;
- Техническая поддержка проекта;
- Защита от снятия компонента с производства.



Как с нами связаться

Телефон: 8 (812) 309 58 32 (многоканальный)

Факс: 8 (812) 320-02-42

Электронная почта: org@eplast1.ru

Адрес: 198099, г. Санкт-Петербург, ул. Калинина, дом 2, корпус 4, литера А.