



Comprehensive
Solutions
for **Reliable Connections**

Complete Solutions for the Electronics Industry

3M Interconnect Solutions offers a comprehensive range of Interconnect Solutions for the electronics industry, with a product portfolio that includes connectors, cables, cable assemblies and assembly tooling for a wide variety of applications.

3M is dedicated to innovation, continually developing new products that become an important part of everyday life across many diverse markets. A number of 3M solution categories are based on custom-designed products for specialized applications. 3M Interconnect Solutions can help you design, modify and customize your product as well as help you seamlessly integrate our products into your manufacturing process on a global basis.

Design,
modify and
customize
your product

Contents

Backplane Connector Solutions	4
Boardmount Connector Solutions	6
Wiremount Connectors and Assembly Solutions	9
Device-to-Board Connector Solutions	13
Input/Output Connector Solutions	16
Cable Solutions	24
Cable Assembly Solutions — High Speed Assemblies	26

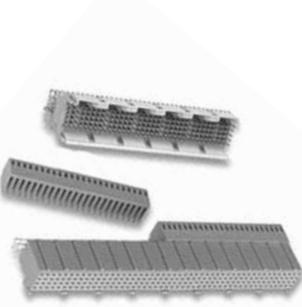

3M™ BACKPLANE CONNECTOR SOLUTIONS

PRODUCT	FEATURES	MATERIALS	PERFORMANCE
<p data-bbox="110 233 266 260">DIN Connectors</p> 	<ul style="list-style-type: none"> • RoHS Compliant Version Available • DIN 41612 • C-Form Plug and Socket • C-Form Wiremount Plugs and Sockets • R-Form Plug and Socket • Q-Form Plug and Socket • B-Form Wiremount Plug and Socket • Pinless Shrouds • Solder Tails or Press-Fit • Inverse Versions • EMLB Contact Loading • PCB Retention Clips 	<p>Contact Material: Copper Alloy</p> <p>Insulation Material: Engineering Thermoplastic</p> <p>Flammability UL 94V-0</p> <p>Plating Underplating: 50 μ" [1.27 μm] Min. Nickel Interface: 30 μ" [0.76 μm] Gold or 3 μ" [0.08 μm] Gold over 7 μ" [0.18 μm] PdNi</p>	<p>Current Rating: 3.0 A @ 30°C T-rise Above Ambient</p> <p>Temperature Rating: -55°C to +125°C</p>
<p data-bbox="61 835 315 863">MetPak™ 2-FB Connectors</p> 	<ul style="list-style-type: none"> • RoHS Compliant Version Available • Futurebus+® • Inverse Version Available • Vertical and Right Angle • Stacking Versions • Elevated Versions • Guiding Features • Pinless Shroud • Power Header and Socket 	<p>Contact Material: Copper Alloy</p> <p>Insulation Material: High Temp LCP</p> <p>Flammability UL 94V-0</p> <p>Plating Underplating: 50 μ" (1.27 μm) Nickel Interface: 10 μ" [0.25 μm] or 30 μ" [0.76 μm] Gold or 3 to 5 μ" [0.07 to 0.12 μm] Gold over 7, 27 or 40 μ" [0.18, 0.69, 1.01 μm] PdNi</p>	<p>Current Rating: Signal: 1.5 A All Contacts Simultaneously</p> <p>Temperature Rating: -55°C to +125°C</p>
<p data-bbox="66 1438 310 1465">MetPak™ CP2 Connectors</p> 	<ul style="list-style-type: none"> • RoHS Compliant Version Available • Compact PCI® • Types A, B, AB and C • Header and Socket • Grounding Options • EMLB Contact Loading • Coding Keys • Pinless Shroud 	<p>Contact Material: Copper Alloy</p> <p>Insulation Material: Glass Filled Polyester</p> <p>Flammability UL 94V-0</p> <p>Plating Underplating: Nickel Wiping Area: 30 μ" [0.76 μm] Gold</p>	<p>Current Rating: 1 A at +70°C</p> <p>Temperature Rating: -55°C to +125°C</p>

3M™ BACKPLANE CONNECTOR SOLUTIONS

PRODUCT	FEATURES	MATERIALS	PERFORMANCE
<p>MetPak™ HM Connectors</p> 	<ul style="list-style-type: none"> • RoHS Compliant Version Available • Hard Metric (HM) • 5- and 8-Row Versions • Optional Four Integrated 8.25 A Power Blades for a Total of 33 A Power; Saves Space and Press-Fit Operations • Socket and Header • Power Options • Protective Caps • Coding Keys • Shielding Options 	<p>Contact Material: Copper Alloy</p> <p>Insulation Material: High Temperature Thermoplastic</p> <p>Flammability UL 94V-0</p> <p>Plating Underplating: 50 μ" [1.27 μm] Nickel Interface: 30 μ" [0.76 μm] Gold or 5 μ" [0.13 μm] Gold over 40 μ" [1.01 μm] PdNi</p>	<p>Current Rating: (Fully Loaded): 1 A at 70°C Signal, 8.25 A @ 70°C Power</p> <p>Temperature Rating: -55°C to +125°C</p>
<p>MetPak™ HSHM Sockets and Headers</p> 	<ul style="list-style-type: none"> • RoHS Compliant Version Available • Low Crosstalk at High Frequencies • Optional Four Integrated 8.25 A Power Blades for a Total of 33 A Power; Saves Space and Press-Fit Operations • 50/100 (Single-Ended/Differential) Impedance • Modular/Scalable Format IEC 61076-4-101 • 63 Mated Lines Per Linear Inch • Press-Fit Headers and Receptacles • End-To-End Stackable with 5 Row 3M™ Metpak™ CP2, HM, and HSHM Headers • High Speed Hard Metric (HSHM) • 8 Gbps Per Second • Orthogonal Design Capable • Differential Pairs in Rows or Columns • Virtual Coax Capable • 5- and 8-Row Versions • Socket and Header • Power Options • Protective Caps for Headers • Coding Keys • Shielding Options • Guide Pin Options 	<p>Contact Material: Copper Alloy</p> <p>Insulation Material: High Temperature Thermoplastic</p> <p>Flammability UL 94V-0</p> <p>Plating Underplating: 50 μ" [1.27 μm] Nickel Interface: 30 μ" [0.76 μm] Gold or 5 μ" [0.13 μm] Gold over 40 μ" [1.01 μm] PdNi</p>	<p>Current Rating: (Fully Loaded): 1 A at 70°C Signal, 8.25 A @ 70°C Power</p> <p>Temperature Rating: -55°C to +125°C</p>
<p>Ultra Hard Metric (UHM) Connectors</p> <p>NEW</p> 	<ul style="list-style-type: none"> • RoHS Compliant • 7+ Gbps Data Rates When Mated to Standard IEC 61076-4-101 2 mm Hard Metric Headers • Low Crosstalk at High Frequencies • 50/100 Ω (Single-Ended/Differential) Impedance • Press-Fit Receptacles Fully Compatible With IEC 61076-4-101 • Dual Beam Contact Construction for High Reliability • End-To-End Stackable with 5 Row 3M Metpak CP2, HM, UHM and HSHM Sockets • Mates With 3M Metpak CP2, HM, UHM, HSHM Headers and Any Other cPCI® Type Headers 	<p>Contact Material: Copper Alloy</p> <p>Insulation Material: High Temperature Thermoplastic (LCP)</p> <p>Flammability UL 94V-0</p> <p>Plating Underplating: 50 μ" [1.27 μm] Nickel Interface: 30 μ" [0.76 μm] Gold</p>	<p>Current Rating: 1 A at 70°C Signal</p> <p>Temperature Rating: -55°C to +125°C</p>

3M™ BOARDMOUNT CONNECTOR SOLUTIONS

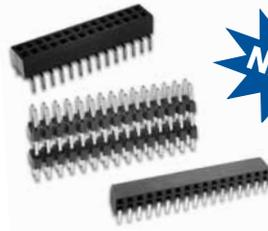
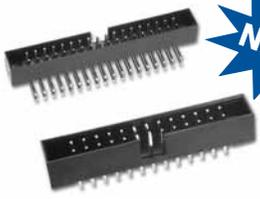
PRODUCT	FEATURES	MATERIALS	PERFORMANCE
Pin Strip Headers Series 95X  	<ul style="list-style-type: none"> • RoHS Compliant • Single and Dual Row • 3 - 80 Positions • High Temperature Dielectric • "No Lead" Wave and Reflow Solder Compatible • Maximizes Use of PC Board Space • End Stackable Feature • Mates with Boardmount and Wiremount Products • Available in Straight, Right Angle Through-Hole and Surface Mount Versions 	<p>Contact Material: Copper Alloy</p> <p>Insulation Material: High Temperature Thermoplastic Color: Black</p> <p>Flammability UL 94V-0</p> <p>Plating Underplating: 1.25–2.5 μm [100 μm] Nickel Wiping Area: 0.25 μm [10 μm] Gold Solder Tail Area: 1–3 μm [40–118 μm] Matte Tin</p>	<p>Current Rating: 1 A Temperature Rating: -40°C to +105°C</p>
Boardmount Pin Strips and Sockets 2 mm, Series 95X  	<ul style="list-style-type: none"> • RoHS Compliant • Maximizes Use of PC Board Space • High Temperature Dielectric • "No Lead" Wave and Reflow Solder Compatible • Dual Row Design, 4–80 Pins • Minimized PC Board Stacking Heights • Mates With Pin Strip Header Products • Available in Straight, Right Angle Through-Hole, Through-Board and Surface Mount Versions 	<p>Contact Material: Copper Alloy</p> <p>Insulation Material: High Temperature Thermoplastic Color: Black</p> <p>Flammability UL 94V-0</p> <p>Plating Underplating: 1.25–2.5 μm [100 μm] Nickel Wiping Area: 0.25 μm [10 μm] Gold Solder Tail Area: 1–3 μm [40–118 μm] Matte Tin</p>	<p>Current Rating: 1 A Temperature Rating: -40°C to +105°C</p>
Box Headers 2 mm x 2 mm, Solder Tail Series 957  	<ul style="list-style-type: none"> • RoHS Compliant • High Temperature Dielectric • "No Lead" Wave and Reflow Solder Compatible • Maximizes Use of PC Board Space • Center Slot Polarization Prevents Mis-Insertions and Reduces Insertion Time • 10 - 68 Positions 	<p>Contact Material: Square Pin 0.5 mm, Copper Alloy</p> <p>Insulation Material: High Temperature Thermoplastic Color: Black</p> <p>Flammability UL 94V-0</p> <p>Plating Underplating: 1.25–2.5 μm [100 μm] Nickel Wiping Area: 0.25 μm [10 μm] Gold Solder Tail Area: 1–3 μm [40–118 μm] Matte Tin</p>	<p>Current Rating: 1 A Temperature Rating: -40°C to +105°C</p>
Sockets and Pin Strip Headers, .100" x .100" Series 929 	<ul style="list-style-type: none"> • RoHS Compliant Version Available • 2-72 Positions • Single- and Dual-Row Options • Through-Hole and Through-Board Options • Customizable Stack Heights from .150" to 1.325" • High Temperature Insulator Option 	<p>Contact Material: Copper Alloy</p> <p>Insulation Material: Glass Filled Polyester (PBT) or PCT (RoHS Compliant)</p> <p>Flammability UL 94V-0</p> <p>Plating Pin Strip Underplating: 50 μm [1.27 μm] Nickel, Interface: 10 μm [0.25 μm] or 30 μm [0.76 μm] Gold Socket Underplating: 100 μm [2.54 μm] Nickel, Interface: 10 μm [0.25 μm] or 30 μm [0.76 μm] Gold Tin Plated Versions Available</p>	<p>Current Rating: 1 A, 2 A or 2.5 A Temperature Rating: -40°C to +105°C</p>
Polarized Boardmount Sockets, .100" x .100" Series 5100, 6800, 8500, 9100 	<ul style="list-style-type: none"> • RoHS Compliant • 10-64 Positions • Vertical and Right Angle Options • Center Bump Polarization 	<p>Contact Material: Copper Alloy</p> <p>Insulation Material: Glass Filled Polyester</p> <p>Flammability UL 94V-0</p> <p>Plating Underplating: 2 μm [79 μm] Nickel Wiping Area: 0.3 μm [12 μm] Gold</p>	<p>Current Rating: 1 A Temperature Rating: -55°C to +105°C</p>
Sockets and Pin Strip Headers, 2 mm x 2 mm Series 15 	<ul style="list-style-type: none"> • RoHS Compliant Version Available • 4-60 Positions • Single and Dual-Row Options • Surface Mount, Through-Hole and Through-Board Options • Customizable Stack Heights from .101" to 1.418" • High Temperature Insulator 	<p>Contact Material: Copper Alloy</p> <p>Insulation Material: Glass Filled PCT</p> <p>Flammability UL 94V-0</p> <p>Plating Underplating: 50-150 μm [1.27-3.81 μm] Nickel Wiping Area: 30 μm [0.76 μm] Gold</p>	<p>Current Rating: 1 A Temperature Rating: -55°C to +105°C</p>

3M™ BOARDMOUNT CONNECTOR SOLUTIONS

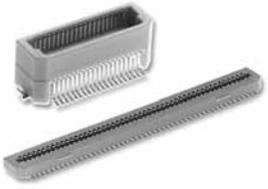
PRODUCT	FEATURES	MATERIALS	PERFORMANCE
Pak 50 Sockets and Headers Series P50 	<ul style="list-style-type: none"> • RoHS Compliant • 20-200 Positions • .050" Pitch • Reliable Ribbon Contacts • 7.0 - 30.0 mm Stack Heights • Parallel, Perpendicular and End-to-End Mating • Audible Tactile "Click" for Blind Mating • Optional Power/Ground Pins • Wiremount Options Available 	Contact Material: Phosphor Bronze Insulation Material: Glass Filled Nylon Flammability UL 94V-0 Plating Underplating: Nickel Wiping Area: 10 μ" [0.25 μm] Gold	Current Rating: 0.5 A Temperature Rating: -55°C to +85°C
Pak 10 Plugs and Connectors Series PK10 	<ul style="list-style-type: none"> • RoHS Compliant • 30-100 Positions • 1.0 mm Pitch • Optional Power/Ground Pins • Parallel, Perpendicular and End-to-End Mating 	Contact Material: Phosphor Bronze Insulation Material: Glass Filled LCP Flammability UL 94V-0 Plating Underplating: Nickel Wiping Area: 2 μ" [0.05 μm] or 4 μ" [0.1 μm] Minimum Gold	Current Rating: 0.5 A Temperature Rating: -55°C to +85°C
Pak 8 Plug Connectors Series P08 	<ul style="list-style-type: none"> • RoHS Compliant • 20-100 Positions • .8 mm Pitch • 3.0 - 8.0 mm Stack Heights 	Contact Material: Copper Alloy Insulation Material: High Temperature Plastic Flammability UL 94V-0 Plating Underplating: 50 μ" [1.27 μm] Nickel Wiping Area: 8 μ" [0.20 μm] Gold	Current Rating: 0.5 A Temperature Rating: -55°C to +85°C
Pak 8 Hermaphroditic Connector Series P08 	<ul style="list-style-type: none"> • RoHS Compliant • 30-100 Positions • .8 mm Pitch • 11.5 mm Mated Height • Mates to Itself, One Part on the Bill of Material 	Contact Material: Phosphor Bronze Insulation Material: High Temperature Plastic Flammability UL 94V-0 Plating Underplating: 50 μ" [1.27 μm] Nickel Wiping Area: 8 μ" [0.20 μm] Minimum Gold	Current Rating: 0.5 A Temperature Rating: -55°C to +85°C
Pak 5 Connectors Series P05N 	<ul style="list-style-type: none"> • RoHS Compliant • 20-100 Positions • .5 mm Pitch • 3.0 - 6.0 mm Stack Height 	Contact Material: Copper Alloy Insulation Material: High Temperature Thermoplastic Flammability UL 94V-0 Plating Underplating: 50 μ" [1.27 μm] Nickel Wiping Area: 8 μ" [0.2 μm] Gold	Current Rating: 0.5 A Per Contact Temperature Rating: -55°C to +85°C
Pak 5 Plugs Series PK5 	<ul style="list-style-type: none"> • RoHS Compliant • 40-160 Positions • .5 mm Pitch • 4.0 - 8.0 mm Stack Heights 	Contact Material: Copper Alloy Insulation Material: Glass filled LCP Flammability UL 94V-0 Plating Underplating: Nickel Wiping Area: 2 μ" [0.05 μm] Minimum Gold over Nickel	Current Rating: 0.3 A Temperature Rating: -55°C to +85°C

3M™ BOARDMOUNT CONNECTOR SOLUTIONS

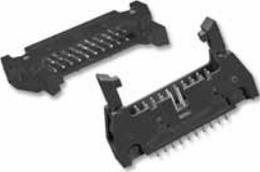
PRODUCT	FEATURES	MATERIALS	PERFORMANCE
<p>4-Wall Low Profile Headers, .100" x .100", Series 2500 and Series D2500</p> 	<ul style="list-style-type: none"> • RoHS Compliant Low Profile, Space Saving Design • Center Slot Polarization • Optional Retainer Clip for Locking Sockets in Place and Increasing Connection Reliability in Vibration Prone Environments • Optional High Temperature Insulator • Straight, Right Angle Through-Hole, and Straight Surfacemount Versions Available • 10-64 Positions 	<p>Contact Material: Brass</p> <p>Insulation Material: High Temp Glass Filled Polyester</p> <p>Flammability UL 94V-0</p> <p>Plating Underplating: 50-100 μ" [1.27 - 2.54 μm] Nickel Wiping Area: 30 μ" [0.76 μm] Gold for 2500 Series 10 μ" [0.25 μm] Gold for D2500 Series Solder Tails: 40-120 μ" [1-3 μm] Matte Tin</p>	<p>Current Rating: 2 A Temperature Rating: -55°C to +105°C</p>
<p>4-Wall Latch/Eject Headers, .100" x .100", Series 3000, Series D3000</p> 	<ul style="list-style-type: none"> • RoHS Compliant Version Available • 10-64 Positions • Straight and Right Angle Tails • Vertical Compliant Pin Option • 3- or 4-Wall Options • Robust Roll Pin Latch System • High Temperature Option 	<p>Contact Material: Copper Alloy</p> <p>Insulation Material: Glass Filled Polyester</p> <p>Flammability UL 94V-0</p> <p>Plating Underplating: 100 μ" [2.54 μm] Nickel - Overall Wiping Area: 30 μ" [0.76 μm] Gold 30 μ" Gold for 3000 Series, 10 μ" Gold for D3000 Series</p>	<p>Current Rating: 2 A Temperature Rating: -55°C to +105°C</p>
<p>Latch/Eject Headers, 2 mm Series 1552</p> 	<ul style="list-style-type: none"> • RoHS Compliant • 13 Pin Counts, Ranging from 6-50 Positions • Robust Ejectors for Vibration Environments and to Reduce Likelihood of Latch Breakage when Ejecting • Mates to 3M™ Sockets, IDC, 1522 Series and 3M™ Molded Cable Assemblies, 2M Series (with Latching Ear Option) 	<p>Contact Material: Copper Alloy</p> <p>Insulation Material: Glass Filled Polyester</p> <p>Flammability UL 94V-0</p> <p>Plating Underplating: 50 μ" [1.27 μm] Nickel Wiping Area: 10 μ" [0.25 μm] Gold or 30 μ" [0.76 μm] Gold Solder Tails: 200 μ" [5.0 μm] Matte Tin</p>	<p>Current Rating: 1 A Temperature Rating: Operating Temperature: -55°C to +105°C</p>
<p>4-Wall Condo Headers, .100" x .100" Series 3400</p> 	<ul style="list-style-type: none"> • RoHS Compliant Version Available • 20-128 Positions • Right Angle Tails • 3- or 4-Wall Options • Robust Roll Pin Latch System • High Temperature Option • 3-Wall Fits in VME Board Stacking Criteria • "HDI" Alternative 	<p>Contact Material: Copper Alloy</p> <p>Insulation Material: Glass Filled Polyester</p> <p>Flammability UL 94V-0</p> <p>Plating Underplating: 100 μ" [2.54 μm] Nickel - Overall Wiping Area: 30 μ" [0.76 μm] Gold</p>	<p>Current Rating: 1 A Temperature Rating: -55°C to +105°C</p>
<p>Surfacemount Latch/Eject Headers, .100" x .100" Series N4600</p> 	<ul style="list-style-type: none"> • RoHS Compliant Version Available • 10-60 Positions • Robust Roll Pin Latch System • High Temperature Body • Raised Body and Gull Wing Leads Allow for Easy Inspection 	<p>Contact Material: Copper Alloy</p> <p>Insulation Material: Glass Filled Polyester</p> <p>Flammability UL 94V-0</p> <p>Plating Underplating: 100 μ" [2.54 μm] Nickel Wiping Area: 30 μ" [0.76 μm] Gold</p>	<p>Current Rating: 1 A Temperature Rating: -55°C to +105°C</p>

3M™ WIREMOUNT CONNECTOR SOLUTIONS

PRODUCT	FEATURES	MATERIALS	PERFORMANCE
Pak 50 Wiremount Sockets Series P25E, P25LE, P50E 	<ul style="list-style-type: none"> • RoHS Compliant • 20-100 Positions • Accepts .025" And .050" Cable • Integrated Latch/Eject • Audible Tactile "Click" for Blind Mating 	<p>Contact Material: Copper Alloy</p> <p>Insulation Material: Glass Filled Polyester</p> <p>Flammability UL 94V-0</p> <p>Plating Underplating: 100 μ" [2.54 μm] Nickel Wiping Area: 10 μ" [0.25 μm] Gold</p>	<p>Current Rating: 0.5 A Temperature Rating: -55°C to +85°C</p>
Link Connectors, .100" IDC Series 381 and 382 	<ul style="list-style-type: none"> • RoHS Compliant • Simple and Low Cost Wiring Solution • Hermaphroditic Mating Wiremount Connector • Meets CC-Link/LT Standard IDC Termination to Discrete Wire or Flat Cable with Standard Pliers • Straight and Right Angle Boardmount Sockets 	<p>Contact Material: Copper Alloy</p> <p>Insulation Material: Glass Filled Polyester (PBT)</p> <p>Flammability UL 94V-0</p> <p>Plating Underplating: 2.54 μm [100 μ"] Minimum Nickel Wiping Area: 0.2 μm [8 μ"] Minimum Gold with Lubricant Solder Tails: Gold Flash</p>	<p>Current Rating: 5.0 A Temperature Rating: -20°C to +70°C</p>
Mini-Clamp Sockets and Plugs, Wiremount Series 371 and 373 	<ul style="list-style-type: none"> • RoHS Compliant • Flexible, Easy-To-Use, Wire-To-Wire or Wire-To-Board Connector System • High Number of Mating Cycles • Mating Latch Features Provide a Reliable Interconnection in Demanding Applications • Allows Easy and Simple Interconnecting of Sensors or Other Discrete Wire Devices • Dust Cap Accessory Available for Use in Harsh Environments 	<p>Contact Material: Copper Alloy</p> <p>Insulation Material: Nylon Color: Black</p> <p>Flammability UL 94V-0</p> <p>Plating Underplating: 2.54 μm [100 μ"] Minimum Nickel Wiping Area: 0.2 μm [8 μ"] Minimum Gold with Lubricant Solder Tails: Gold Flash</p>	<p>Current Rating: 3.0 Amps Temperature Rating: -20°C to +85°C Ambient (1.0 A max.) -20°C to +75°C Ambient (2.0 A max.) -20°C to +60°C Ambient (3.0 A max.)</p>
Mini-Clamp Sockets, 2 mm, Boardmount and SMT Series 372 	<ul style="list-style-type: none"> • RoHS Compliant • Low Profile Design Minimizes Overall Thickness • Compact Design Saves Board Space • Multiple PCB Locating Post Layouts to Provide Competitive Compatibility • Solder Tab Design Helps Provide a Reliable Solder Joint • Matching Latch Feature Provides a Reliable Interconnection in Demanding Applications • High Number of Mating Cycles (300) • Maximum Current Rating of 3 Amps • Dust Cover Accessory Available For Use in Harsh Environments 	<p>Contact Material: Copper Alloy</p> <p>Insulation Material: LCP Color: Black</p> <p>Flammability UL 94V-0</p> <p>Plating Underplating: Nickel Wiping Area: 0.2 μm [8 μ"] Minimum Gold with Lubricant Solder Tails: Gold Flash</p>	<p>Current Rating: 3.0 Amps Temperature Rating: -20°C to +85°C Ambient (1.0 A max.) -20°C to +75°C Ambient (2.0 A max.) -20°C to +60°C Ambient (3.0 A max.)</p>
Power Clamp Sockets, Headers and Branch Series 355, 356 and 357 	<ul style="list-style-type: none"> • RoHS Compliant • 5 Position • Wiremount Socket • Vertical Header • Branch Header • Easy, Labor Saving and Reliable IDC Termination • Accommodates 18 - 20 AWG Discrete Wire • No Special Wire Preparation Required • Field Terminatable with a Common Pliers • Polarization Provides Proper Interconnecting of Mated Pairs • Based on CC-Link Standard 	<p>Contact Material: Copper Alloy</p> <p>Insulation Body Material: Nylon</p> <p>Flammability UL 94V-0</p> <p>Plating Underplating: 2.5 μm Minimum Nickel Wiping Area: 0.5 μm Minimum Gold Solder Tails: Gold Flash</p>	<p>Current Rating: 10 A Maximum (1 Contact) 7 A Maximum (2 or More Contacts) Temperature Rating: -20°C to +75°C Ambient</p>

3M™ WIREMOUNT CONNECTOR AND ASSEMBLY SOLUTIONS

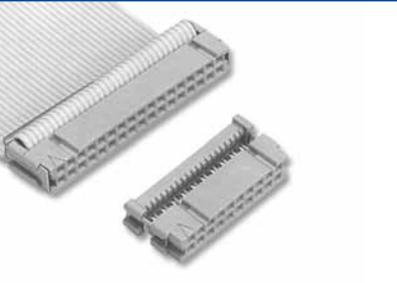
PRODUCT	FEATURES	MATERIALS	PERFORMANCE
Wiremount Sockets, .100" x .100" Series 3000 	<ul style="list-style-type: none"> • RoHS Compliant • 10-60 Positions • Two-Piece with Adhesive Cover for Daisy Chain or Round-to-Flat Cable Applications • Plastic or Metal Strain Relief Option • Positive Locking Metal Clip for High Cover Retention • Open or Closed-End Covers 	<p>Contact Material: Beryllium Copper</p> <p>Insulation Material: Glass Filled Polyester</p> <p>Flammability UL 94V-0</p> <p>Plating Underplating and U-Slot: 100 μ" [2.54 μm] Nickel Wiping Area: 30 μ" [0.76 μm] Gold</p> <p>Wire Accommodation: 26 and 28 AWG Stranded</p>	<p>Current Rating: 1 A Temperature Rating: -55°C to +105°C</p>
Wiremount Sockets, .100" x .100" Series 891, Series D89 	<ul style="list-style-type: none"> • RoHS Compliant • Pre-Assembled for High Efficiency • Pre-Assembled, Designed to Terminate Faster Than Two-Piece Sockets, "Sword" Packaging Makes Easy Loading of Manual And Semi-Automatic Assembly Equipment • "Bumps" Prevent Premature Latch Locking During Shipment • Military Polarization, with or without Centerbump • Optional Double-Sided Adhesive Pull Tab For Easy Unplugging • Double-Recessed Cover for Cable Terminating From Either Side Virtually Eliminates Need for Single-Recessed Cover Connectors 	<p>Contact Material: Phosphor Bronze</p> <p>Insulation Material: Glass Filled Polyester (PBT) Color: Gray</p> <p>Flammability UL 94V-0</p> <p>Plating Underplating: 50 μ" [1.27 μm] Nickel Wiping Area: 30 μ" [0.76 μm] or 10 μ" [0.25 μm] Gold</p> <p>Wire Accommodation: 26 and 28 AWG Stranded</p>	<p>Current Rating: 2 A (EIA 364-70) Temperature Rating: -55°C to +105°C</p>
Molded Socket Assembly, .100" x .100" Series 87, 1M 	<ul style="list-style-type: none"> • RoHS Compliant When Used with Compliant Cable • 6-64 Positions • Supplied as Complete Assembly Only (1M Series) • Mates with Standard 0.25" Square Contacts on .100" x .100" Centers • One Piece, Molded-on Construction Provides Integral Strain Relief • High and Low Profile, Polarity and Pull Tab Options Available 	<p>Contact Material: Copper Alloy</p> <p>Insulation Material: Glass Filled Polyester</p> <p>Plating Underplating and U-Slot: 50 - 150 μ" [1.27 - 3.81 μm] Nickel Wiping Area: 30 μ" [0.76 μm] Gold</p>	<p>Current Rating: 1 A Temperature Rating: -55°C to +105°C</p>
Polarized Wiremount Sockets, .100" and .100" x .100" Series CHG 	<ul style="list-style-type: none"> • RoHS Compliant • 10-64 Positions • Single- and Dual-Row Side-to-Side Stackable • Single-Row 2-36 Positions • Dual-Row 6-72 Positions • Dual-Row Polarized Version • IDC with Individual Strain Reliefs on Each Contact • 22-28 AWG Discrete or Flat Cable Wire 	<p>Contact Material: Copper Alloy</p> <p>Insulation Material: Glass Filled Polyester</p> <p>Flammability UL 94V-0</p> <p>Plating Wipe Area: 30 μ" [0.76 μm] Gold Underplating and U-Slot: 100 μ" [2.54 μm] Nickel</p>	<p>Current Rating: 22-24 AWG: 2 A; 26-28 AWG: 1.5 A Temperature Rating: -55°C to +105°C</p>
Wiremount Plugs, .100" x .100" Series 4600 	<ul style="list-style-type: none"> • RoHS Compliant • 10-64 Positions • Open- or Closed-End Covers • Optional Ejector Latchwches • Optional Mounting Flanges • Plastic Strain Relief Option 	<p>Contact Material: Copper Alloy</p> <p>Insulation Material: Glass Filled Polyester</p> <p>Flammability UL 94V-0</p> <p>Plating Underplating and U-Slot: 100 μ" [2.54 μm] Nickel Wiping Area: 30 μ" [0.76 μm] Gold</p>	<p>Current Rating: 1 A Temperature Rating: -55°C to +120°C</p>

3M™ WIREMOUNT CONNECTOR SOLUTIONS

PRODUCT	FEATURES	MATERIALS	PERFORMANCE
<p>Tripolarized Wiremount Sockets, .050" x .100" Series 82</p> 	<ul style="list-style-type: none"> • RoHS Compliant Version Available • 20-100 Positions • Rugged Tri-Polarized Mating System • High Performance Hill-n-Dale IDC Interface • Metal Cover Latch • Optional Metal Strain Relief • Compatible with PVC, TPE and FEP Cable Insulations 	<p>Contact Material: Copper Alloy</p> <p>Insulation Material: Glass Filled Polyester</p> <p>Flammability UL 94V-0</p> <p>Plating Underplating: 100 μ" [2.54 μm] Nickel</p> <p>U-Slot: Matte Tin (RoHS compliant) or Tin-Lead</p> <p>Wiping Area: 30 μ" [0.76 μm] Gold</p>	<p>Current Rating: 0.5 A Temperature Rating: -55°C to +105°C</p>
<p>4-Wall, Tripolarized Headers, .050" x .100" Series 81</p> 	<ul style="list-style-type: none"> • RoHS Compliant Version Available • 20-100 Positions • Straight and Right Angle • Vertical SMT Option • High Temperature 	<p>Contact Material: Copper Alloy</p> <p>Insulation Material: High Temperature Plastic</p> <p>Flammability UL 94V-0</p> <p>Plating Wiping Area: 30 μ" [0.76 μm] Gold</p> <p>Underplating: 100 μ" [2.54 μm] Nickel</p>	<p>Current Rating: 0.5 A Temperature Rating: -55°C to +105°C</p>
<p>PCB 2-Row, .100" x .100" Series 78</p> 	<ul style="list-style-type: none"> • RoHS Compliant • 10-64 Positions • Low Profile • 2.8 or 3.8 mm Tail Options 	<p>Contact Material: Beryllium Copper</p> <p>Insulation Material: Glass Filled Polyester</p> <p>Flammability UL 94V-0</p> <p>Plating Underplating: 100 μ" [2.54 μm] Nickel U Slot and Solder Tails: Gold Flash</p>	<p>Current Rating: 1 A Temperature Rating: -55°C to +105°C</p>
<p>PCB 4-Row, .100" x .100" Series 3400</p> 	<ul style="list-style-type: none"> • RoHS Compliant Version Available • 10-50 Positions • Low Profile Design 	<p>Contact Material: Copper Alloy</p> <p>Insulation Material: Glass Filled Polyester</p> <p>Flammability UL 94V-0</p> <p>Plating Underplating: 100 μ" [2.54 μm] Nickel, Class 2</p> <p>U-Slot and Solder Tails: 10 μ" [0.25 μm] Gold or 200 μ" [5.08 μm] Tin Lead</p>	<p>Current Rating: 1 A Temperature Rating: -55°C to +120°C</p>

3M™ WIREMOUNT CONNECTOR AND ASSEMBLY SOLUTIONS

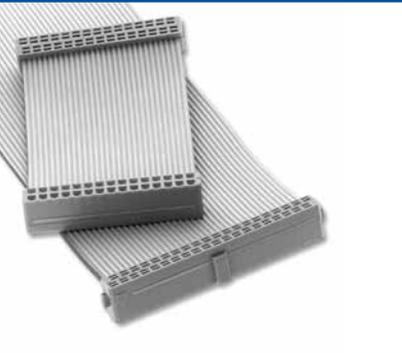
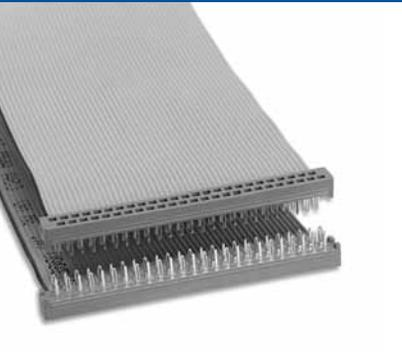
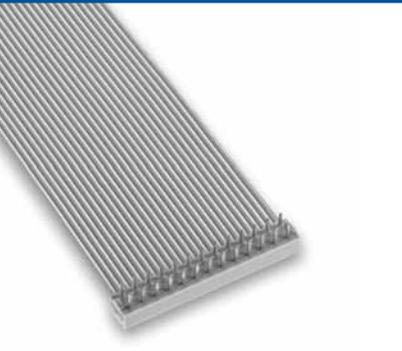
PRODUCT	FEATURES	MATERIALS	PERFORMANCE
<p>Wiremount Sockets, 2 mm x 2 mm Series 1522</p> 	<ul style="list-style-type: none"> • RoHS Compliant • 10 - 50 Positions • Rugged Cover Retention • Pre-Assembled for High Efficiency • Low Profile Metal Strain Relief Option • Open or Closed Cover 	<p>Contact Material: Copper Alloy</p> <p>Insulation Material: Glass Filled Polyester (PBT) Color: Gray</p> <p>Flammability UL 94V-0</p> <p>Plating Underplating and U-Slot: 50-150 μ" [1.27-3.81 μm] Nickel-QQ-N-290, Class 2 Wiping Area: Gold, MIL-G-45204, Type II Grade C</p>	<p>Current Rating: 1 A Temperature Rating: -55°C to +105°C</p>
<p>Molded Socket Assembly, 2 mm x 2 mm Series 87, 2M</p> 	<ul style="list-style-type: none"> • RoHS Compliant When Used with Compliant Cable • Available in Multiple Sizes • Sockets Mate with Standard 2 mm x 2 mm Headers and Plugs • Molded-In Strain Relief 	<p>Material Varies for Connectors and Cables. See Website for Specifics.</p>	<p>Current Rating: 1 A Temperature Rating: -55°C to +105°C</p>
<p>Molded PCB Assembly, .100" x .100" Series 87, 1M</p> 	<ul style="list-style-type: none"> • RoHS Compliant When Used with Compliant Cable • 6-64 Positions • Supplied as Complete Assembly Only (1M Series) • Mates with Standard .100" x .100" Board Pattern • One Piece, Molded-on Construction Provides Integral Strain Relief • Straight and Retention Pin Options Available 	<p>Contact Material: Copper Alloy</p> <p>Insulation Material: Glass Filled Polyester</p> <p>Plating Underplating and U-Slot: 50 - 150 μ" [1.27 - 3.81 μm] Nickel Contact Tail: 300 - 400 μ" [7.62 - 10.16 μm] Matte Tin</p>	<p>Current Rating: 1 A Temperature Rating: -55°C to +105°C</p>
<p>Molded PCB Assembly, 2 mm x 2 mm Series 87, 2M</p> 	<ul style="list-style-type: none"> • RoHS Compliant When Used with Compliant Cable • 6-50 Positions • Supplied as Complete Assembly Only (2M Series) • Mates with Standard 2 mm x 2 mm Board Pattern • One Piece, Molded-on Construction Provides Integral Strain Relief 	<p>Contact Material: Copper Alloy</p> <p>Insulation Material: Glass Filled Polyester</p> <p>Plating Underplating and U-Slot: 50-150 μ" [1.27 - 3.81 μm] Nickel, Class 2 [2.62 - 10.10 μm] Matte Tin Contact Tail: 300-400 μ"</p>	<p>Current Rating: 1 A Temperature Rating: -55°C to +105°C</p>

3M™ DEVICE-TO-BOARD CONNECTOR SOLUTIONS

PRODUCT	FEATURES	MATERIALS	PERFORMANCE
<p>CF Card Headers, CompactFlash™ Series N7E50</p> 	<ul style="list-style-type: none"> • RoHS Compliant • Headers for Both Type I and II Cards • Wide Array of Connector Size Options to Balance Between Footprint Size and Functionality 	<p>Contact Material: Copper Alloy</p> <p>Insulation Material: High Temperature Thermoplastic</p> <p>Flammability UL 94V-0</p> <p>Plating Underplating: 2.03 μm [80 μ"] Nickel Wiping Area: 0.38 μm [15 μ"] or 0.76 μm [30 μ"] Gold</p>	<p>Current Rating: 0.5 A Temperature Rating: -40°C to +85°C</p>
<p>CF Card Ejectors, CompactFlash™ Series 7E50</p> 	<ul style="list-style-type: none"> • RoHS Compliant • Mates to Selected N7E50 Series CF Headers to Provide Added Ejection Functionality • Multiple Button Styles and Orientations Allow Design Flexibility 	<p>Button Material: Glass-Filled High Temperature Thermoplastic</p> <p>Frame Material: Stainless Steel</p> <p>Flammability UL 94V-0</p>	<p>Process Rating: 260°C (per J-STD-020C)</p>
<p>Serial Attached SCSI (SAS) Connectors Series SBR and SBH</p> 	<ul style="list-style-type: none"> • RoHS Compliant • 6.0 Gbps Input/Output Connector for Backplane Applications • Two Contact Mating Levels for Early-Mate and Late-Break Allows “Blind Mating” or “Hot Swap” Applications • Capable of Accepting SFF-Compliant HDD Fitted with SAS or Serial Advanced Technology Attachment (SATA) Header <p>OPTIONS</p> <ul style="list-style-type: none"> • Elevated Receptacle Version for Additional Backplane Stand-off • Plated Through-Hole, Press-Fit or SMT Available • Right Angle Version Available • 29-Position Device Plugs for Drive Interface • 29-Position Combo with Power 	<p>Contact Material: Copper Alloy</p> <p>Insulation Material: High Temperature Thermoplastic</p> <p>Flammability UL 94V-0</p> <p>Plating Underplating: 50 μ" [1.27 μm] Nickel Wiping Area: 30 μ" [0.76 μm] Gold Solder Tails: 100 μ" [2.54 μm] Tin</p>	<p>Current Rating: Power Pin: 1.5 A Signal Pin: 500 mA Temperature Rating: -40°C to +85°C</p>
<p>Serial Advanced Technology Attachment (SATA) Connectors Series 5607 and 5622</p> 	<ul style="list-style-type: none"> • RoHS Compliant • 3 Gbps I/O Connector for HDD Applications • EMLB Contacts for Hot Swap • Blind Mate Polarization • Meets SATA 2.6 Specifications <p>OPTIONS</p> <ul style="list-style-type: none"> • Plated Through-Hole, Press-Fit or SMT Available • Extended Height Receptacles for Additional Backplane Standoff • Right Angle Surface Mount Receptacle • 7-Pin Signal Plug • 22-Position Device Plugs for Drive Interface • 22-Position Combo with Power 	<p>Contact Material: Copper Alloy</p> <p>Insulation Material: High Temperature Thermoplastic</p> <p>Flammability UL 94V-0</p> <p>Plating Underplating: 50 μ" [1.27 μm] Nickel Wiping Area: 30 - 40 μ" [0.76 μm] Gold Solder Tails: 100 μ" [2.54 μm] Tin</p>	<p>Current Rating: Power Pin: 1.5 A Signal Pin: 500 mA Temperature Rating: Operating Temperature: 0°C to +55°C Non-Operating Temperature: -40°C to +85°C</p>

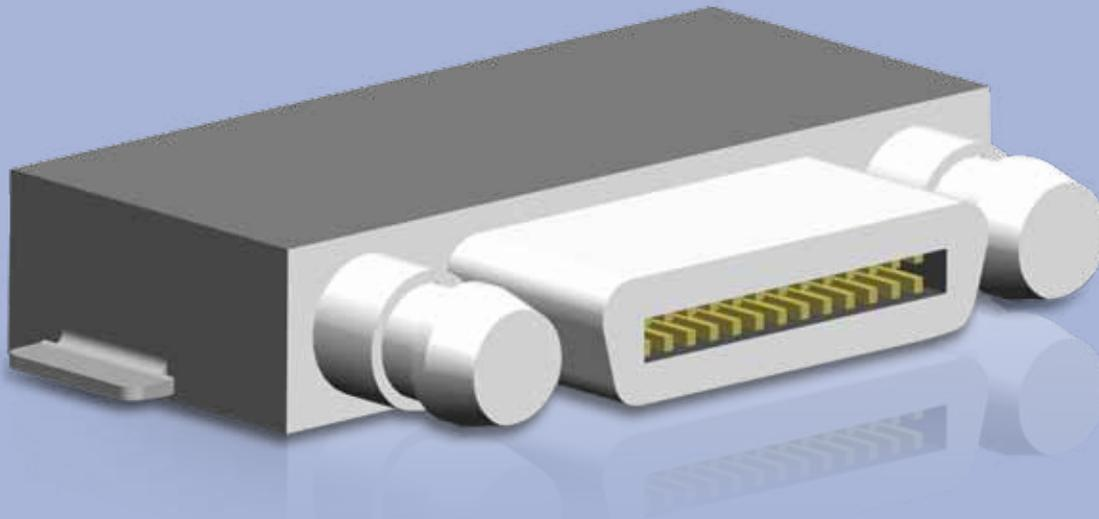

3D CAD models are available on the 3M website

3M Interconnects Solutions now offers 3D CAD models of select products on our website, 3M.com/interconnects.

On the website, these models can be found in the Product Search box by clicking on “3D Models” and can also be found throughout the website if you choose to search for a corresponding product first. Contact your local 3M sales representative for information on CAD models of other products.

To view or open a 3D model, you must have a CAD program and the WinZip® software. To download, right-click on the desired file and choose the option to “save to desktop.”

3M™ DEVICE-TO-BOARD CONNECTOR AND ASSEMBLY SOLUTIONS

PRODUCT	FEATURES	MATERIALS	PERFORMANCE
<p>Serial Advanced Technology Attachment (SATA) Cables Series 5601, 5602</p> 	<ul style="list-style-type: none"> • RoHS Compliant • 7-Position Serial Signal Assembly • Multiple Variations in Length and Interface Attachments • Point-to-Point Signaling • Polarized Interface Provides Proper Alignment • 26 AWG Differential Pairs • Meets SATA 2.6 Specification 	<p>Insulation Material: High Temperature Thermoplastic</p> <p>Plating Wiping Area: 30 μ" [0.76 μm] Gold Solder Tails: 100 μ" [2.54 μm] Tin Underplating: 50 μ" [1.27 μm] Nickel</p>	<p>Current Rating: 1 A Temperature Rating: -20°C to +85°C</p>
<p>Mini Serial Attached SCSI (miniSAS) Connectors, Series 8A26/8C26, 8A36/8B36, 8AB36</p> 	<ul style="list-style-type: none"> • RoHS Compliant • 6 Gbps Data Rate • Combination Connector with Attached Shell Available • Multiple Keying Options • Multiple Tail Options and Lengths Available on Shell • Meets SAS 1.1 Specification • Solder Hold Down Option on 26-Position Right Angle Receptacle Available • External Housing Available in 1, 2 or 4 Ports 	<p>Contact Material: Copper Alloy</p> <p>Insulation Material: High Temperature Thermoplastic</p> <p>Flammability UL 94V-0</p> <p>Plating Underplating: 50 μ" [1.27 μm] Nickel Wiping Area: 30 μ" [0.76 μm] Gold Solder Tails: 100 μ" [2.54 μm] Tin</p>	<p>Current Rating: 0.5 A Temperature Rating: -20°C to +85°C</p>
<p>miniSAS External Cable Assemblies Series 8M26</p> 	<ul style="list-style-type: none"> • RoHS Compliant • Capable of 6 Gbps Per Channel Data Rate • 26 Conductor Signal Assembly • Multiple Lengths Available • Metal Latch • Pull Tab Ring Provides Easier Unmating • Two Levels of EMLB for Hot Plugging • Multiple Key Options Available 	<p>Connector Backshell Material: Zinc Diecast</p> <p>Plating 30 μ" [0.76 μm] Nickel</p> <p>Contact PCB Material: FR4 Underplating: 50 μ" [1.27 μm] Nickel Wiping Area: 30 μ" [0.76 μm] Gold Cable Conductor: Tin Plated Solid Conductor (AWG Depends on Length) Drain Wire: Tin Plated Solid Conductor Dielectric: Foam Polyethylene Shield: Mylar Jacket: Non-PVC</p> <p>Pulltab Material: Nylon Color: Blue</p>	<p>Current Rating: Per Contact: 0.5 A Operating Temperature: -20°C to +75°C</p>

3M™ INPUT/OUTPUT CONNECTOR SOLUTIONS MINI DELTA RIBBON (MDR)

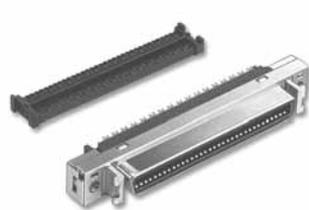
PRODUCT	FEATURES	MATERIALS	PERFORMANCE
<p>MDR Wiremount Plugs - IDC Series 101XX-60X0, 101XX-8000</p> 	<ul style="list-style-type: none"> • RoHS Compliant • 14-100 Positions • Wiper-on-Wiper Contact for Reliable Repetitive Plugging • Digital LCD Interface as a 20 or 26 Contact Connector • IEEE 1284C Interface as a 36 Contact Connector • Camera Link® Interface as a 26 Contact Connector • Accepts a Wide Variety of Cable Constructions Including Split, Flat, Round, Twisted Pair and Twinax Cables • Accepts a Wide Variety of Shielded Junction Shells <p>OPTIONS</p> <ul style="list-style-type: none"> • Plastic-Non Shielded Version • Termination Tools • Junction Shells 	<p>Contact Material: Beryllium Copper</p> <p>Insulation Material: Glass Reinforced Polyester</p> <p>Flammability UL 94V-0</p> <p>Plating Underplating: 80 μ" [2.0 μm] Nickel Wiping Area: 30 μ" [0.76 μm] Gold</p>	<p>Current Rating: 1 A Temperature Rating: -20°C to +85°C</p>
<p>MDR Wiremount Plugs - Solder Series 101XX-3000</p> 	<ul style="list-style-type: none"> • RoHS Compliant Version Available • 14-50 Positions • Wiper-on-Wiper Contact for Reliable Repetitive Plugging • Solder Cup Termination Requires No Special Tooling • Accepts a Wide Variety of Discrete Wire (24 to 30 AWG) Cable Construction <p>OPTIONS</p> <ul style="list-style-type: none"> • Junction Shells • Camera Link Interface as a 26 Contact Connector 	<p>Contact Copper Alloy</p> <p>Insulation Glass Reinforced Polyester</p> <p>Flammability UL 94V-0</p> <p>Plating Underplating: 80 μ" [2.0 μm] Nickel Wiping Area: Gold</p>	<p>Current Rating: 1 A Temperature Rating: -55°C to +105°C</p>
<p>MDR Panelmount Receptacles - IDC Series 102XX-0210</p> 	<ul style="list-style-type: none"> • RoHS Compliant • 20-68 Positions • Wiper-on-Wiper Contact for Reliable Repetitive Plugging • IEEE 1284C Interface as a 36 Contact Connector • Interface Latch Design for Connection Stability • Accepts a Wide Variety of Cable Constructions Including Flat, Shielded Flat and Twisted Pair Cables • Replaces Boardmount Receptacle When a Wire Transition Is Needed <p>OPTION</p> <ul style="list-style-type: none"> • Wire Termination Tools • Camera Link Interface as a 26 Contact Connector 	<p>Contact Material: Beryllium Copper</p> <p>Insulation Glass Reinforced Polyester</p> <p>Flammability UL 94V-0</p> <p>Plating Underplating: 80 μ" [2.0 μm] Nickel Wiping Area: 30 μ" [0.76 μm] Gold</p>	<p>Current Rating: 1 A Temperature Rating: -20°C to +85°C</p>
<p>MDR Junction Shells, Round Cable Exit, Plastic Series 103XX</p> 	<ul style="list-style-type: none"> • RoHS Compliant • 14-80 Positions • Durable One-Piece Plastic Over Two-Piece Metal Junction Shell for Straight Round Cable (Compatible with 101XX-6000 EC Plug) • MDR Digital LCD Interface as a 20 or 26 Contact Connector <p>OPTIONS</p> <ul style="list-style-type: none"> • 80 Position • Quick Release Latching or Secure Thumbscrew Versions Available 	<p>Outer Shell Material: ABS</p> <p>Inner Shell Material: Steel</p> <p>Flammability UL 94V-0</p> <p>Plating Nickel</p>	

3M™ INPUT/OUTPUT CONNECTOR SOLUTIONS MINI DELTA RIBBON (MDR)

PRODUCT	FEATURES	MATERIALS	PERFORMANCE
<p>MDR Junction Shells, Round Cable Exit, Metal Series 103XX</p> 	<ul style="list-style-type: none"> • RoHS Compliant • 14-100 Positions • Metal Junction Shell for Round Cable • Rugged Two-Piece Die Cast Metal Shell with Round Straight Exit (Compatible with 101XX-6000 EC Plug) • Reliable Metal Strain Relief Clamp Provides Grounding for Cable Shield • Excellent EMI/ESD Protection • Quick Release Latching Mechanism <p>OPTION</p> <ul style="list-style-type: none"> • 60 Degree Cable Relief Option 	<p>Shell Aluminum</p> <p>Plating Nickel</p>	
<p>MDR Junction Shells, Flat Cable Exit, Metal Series 103XX</p> 	<ul style="list-style-type: none"> • RoHS Compliant • Metal Junction Shell for Flat Cable • 20-50 Positions • Rugged Two-Piece Metal Shells for High Performance Pleated Foil Cable Assemblies (Compatible with 101XX-6000 EC Plug) • Kit Includes Conductive Gasket for Cable Shield to Shell Continuity • Accepts 3M 50 Ohm PFC Cables 	<p>Shell Material: Zinc</p> <p>Gasket Material: Elastomer with Conductive Fibers</p> <p>Plating Nickel</p>	
<p>MDR Junction Shells, Flat Cable Exit, Metal Series 103XX</p> 	<ul style="list-style-type: none"> • RoHS Compliant • Rugged Two-Piece Metal Junction Shell for Straight Flat Cable (Compatible with 101XX-6000 EC Plug) • 68-100 Positions • Jackscrew Latching for Connection Stability • Kit Includes Gasket for Cable Shield to Shell Continuity. Accepts 3M™ PFC Cables, 50 Ohm 	<p>Shell Zinc</p> <p>Gasket Material: Elastomer with Conductive Fibers</p> <p>Plating Nickel</p>	
<p>MDR Junction Shells, Round Cable, Solder Cup Series 103XX</p> 	<ul style="list-style-type: none"> • RoHS Compliant • 14-50 Positions • Design Features Durable Two-Piece Glass Reinforced Polyester Backshell with Ground Strap (Compatible with 101XX-3000 Plug) • Round Straight Exit • Reliable Metal Strain Relief Clamp Provides Grounding for Cable Shield • Quick Release Metal Latching Mechanism 	<p>Outer Shell Glass Reinforced Polyester</p> <p>Cable Clamp and Ground Plate Material: Stainless Steel</p> <p>Flammability UL 94V-0</p>	<p>Temperature Rating: -20°C to +85°C</p>

3M™ INPUT/OUTPUT CONNECTOR SOLUTIONS MINI DELTA RIBBON (MDR)

PRODUCT	FEATURES	MATERIALS	PERFORMANCE
<p>MDR Boardmount Receptacles, SMT Vertical Series 102XX</p> 	<ul style="list-style-type: none"> • RoHS Compliant Version Available • 20-36 Positions • Wiper-on-Wiper Contact for Reliable Repetitive Plugging • SMT Compatible PCT Insulator Material • Screw Lock-Down for Reliable PCB Retention • Interface Latch Design for Connection Stability • IEEE 1284C Interface as a 36 Contact Connector • Camera Link® Interface as a 26 Contact Connector <p>OPTIONS</p> <ul style="list-style-type: none"> • Dust Covers • Board Lock and Panel Mount Hardware 	<p>Contact Copper Alloy</p> <p>Insulation Glass Reinforced Polyester</p> <p>Flammability UL 94V-0</p> <p>Plating Underplating: 80 μ" [2.00 μm] Nickel Wiping Area: 30 μ" [0.76 μm] Minimum Gold</p>	<p>Current Rating: 1 A Temperature Rating: -55°C to +105°C</p>
<p>MDR Boardmount Receptacles, SMT Right Angle Series 102XX</p> 	<ul style="list-style-type: none"> • RoHS Compliant Version Available • 14-50 Positions • Wiper-on-Wiper Contact for Reliable Repetitive Plugging • Ultra-Low Signal Skew for High Data Rate Transmission • Interface Latch Design for Connection Stability • Digital LCD Interface as a 20 or 26 Contact Connector • Camera Link® Interface as a 26 Contact Connector • Contacts: 14, 20, 26, 40 and 50 	<p>Contact Copper Alloy</p> <p>Insulation Glass Reinforced Polyester</p> <p>Flammability UL 94V-0</p> <p>Plating Underplating: 80 μ" [2.00 μm] Nickel Wiping Area: 20 μ" [0.50 μm] Minimum Gold</p>	<p>Current Rating: 1 A Temperature Rating: -55°C to +105°C</p>
<p>MDR Boardmount Receptacles, PTH Vertical Series 102XX</p> 	<ul style="list-style-type: none"> • RoHS Compliant Version Available • 14-100 Positions • Wiper-on-Wiper Contact for Reliable Repetitive Plugging • Rugged Die Cast Metal Case Construction • Screw Lockdown for Reliable PCB Retention • Interface Latch Design for Connection Stability • IEEE 1284C Interface as a 36 Contact Connector <p>OPTIONS</p> <ul style="list-style-type: none"> • Dust Covers • Board Lock and Panel Mount Hardware 	<p>Contact Copper Alloy</p> <p>Insulation Glass Reinforced Polyester</p> <p>Flammability UL 94V-0</p> <p>Plating Underplating: 80 μ" [2.00 μm] Nickel Wiping Area: 30 μ" [0.76 μm] Minimum Gold</p>	<p>Current Rating: 1 A Temperature Rating: -20°C to +85°C</p>

3M™ INPUT/OUTPUT CONNECTOR SOLUTIONS MINI DELTA RIBBON (MDR)

PRODUCT	FEATURES	MATERIALS	PERFORMANCE
MDR Boardmount Receptacles, Compliant Pin Vertical Series 102XX 	<ul style="list-style-type: none"> • RoHS Compliant • 14-100 Positions • Wiper-on-Wiper Contact for Reliable Repetitive Plugging • Rugged Die Cast Metal Case Construction OPTIONS <ul style="list-style-type: none"> • Dust Covers • Board Lock and Panel Mount Hardware 	Contact Copper Alloy Insulation Glass Reinforced Polyester Flammability UL 94V-0 Plating Underplating: 80 μ" [2.00 μm] Nickel Wiping Area: 30 μ" [0.76 μm] Minimum Gold	Current Rating: 1 A Temperature Rating: -20°C to +85°C
MDR Boardmount Receptacles, PTH Right Angle Series 102XX 	<ul style="list-style-type: none"> • RoHS Compliant • 14-100 Positions • Wiper-on-Wiper Contact for Reliable Repetitive Plugging • Rugged Die Cast Metal Case Construction Available • SMT Compatible PCT Insulator Material • Screw or Ground Lock for Reliable PCB Retention • Interface Latch Design for Connection Stability • IEEE 1284C Interface as a 36 Contact Connector OPTIONS <ul style="list-style-type: none"> • Stamped Metal Face and Die Cast Versions • Dust Covers • Board Lock and Panel Mount Hardware 	Contact Copper Alloy Insulation Glass Reinforced Polyester (PCT) Flammability UL 94V-0 Plating Underplating: 80 μ" [2.00 μm] Nickel Wiping Area: 30 μ" [0.76 μm] Minimum Gold	Current Rating: 1 A Temperature Rating: -55°C to +105°C
MDR Boardmount Receptacles, PTH Right Angle Condo Series 102XX 	<ul style="list-style-type: none"> • RoHS Compliant Version Available • Positions 40 (2 x 20), 100 (2 x 50) and 136 (2 x 68) • Wiper-on-Wiper Contact for Reliable Repetitive Plugging • Rugged Die Cast Metal Case Construction • Screw Lockdown for Reliable PCB Retention • Interface Latch Design for Connection Stability • Stacked Receptacles Save Board Space OPTIONS <ul style="list-style-type: none"> • Dust Covers • Board Lock and Panel Mount Hardware 	Contact Copper Alloy Insulation Glass Reinforced Polyester Flammability UL 94V-0 Plating Underplating: 80 μ" [2.00 μm] Nickel Wiping Area: 20 μ" [0.50 μm] Minimum Gold	Current Rating: 1 A Temperature Rating: -20°C to +85°C
MDR Boardmount Plugs, PTH Vertical Series 101XX 	<ul style="list-style-type: none"> • RoHS Compliant Version Available • Wiper-on-Wiper Contact for Reliable Repetitive Plugging • Contacts: 50 and 100 	Contact Material: Copper Alloy Insulation Material: Glass Reinforced Polyester Flammability UL 94V-0 Plating Underplating: 80 μ" [2.00 μm] Nickel Wiping Area: 8 μ" [0.20 μm] Minimum Gold	Current Rating: 1 A Temperature Rating: -20°C to +85°C

3M™ INPUT/OUTPUT CONNECTOR SOLUTIONS MINI DELTA RIBBON (MDR)

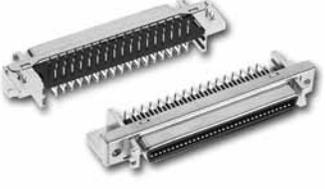
PRODUCT	FEATURES	MATERIALS	PERFORMANCE
<p>MDR Boardmount Plugs, PTH Right Angle Series 101XX</p> 	<ul style="list-style-type: none"> • RoHS Compliant Version Available • 20-50 Positions • Wiper-on-Wiper Contact for Reliable Repetitive Plugging • Rugged Die Cast Metal Case Construction • Screw or Ground Lock PCB Retention • IEEE 1284C Interface as a 36 Contact Connector <p>OPTIONS</p> <ul style="list-style-type: none"> • Normal and Reverse "D" Interface Options • Panel and Board Locking Hardware 	<p>Contact Copper Alloy (C521)</p> <p>Insulation Glass Reinforced Polyester-Body Glass Reinforced Polyester-Alignment Plate</p> <p>Flammability UL 94V-0</p> <p>Plating Underplating: 80 µ" [2.00 µm] Nickel Wiping Area: 30 µ" [0.76 µm] Minimum Gold</p>	<p>Current Rating: 1 A Temperature Rating: -20°C to +85°C</p>
<p>MDR Boardmount Plugs, Straddle Mount Series 101XX</p> 	<ul style="list-style-type: none"> • RoHS Compliant Version Available • 26, 50, 68 and 100 Positions • Wiper-on-Wiper Contact for Reliable Repetitive Plugging • Solder Tails Require No Special Tooling 	<p>Contact Copper Alloy (C521)</p> <p>Insulation Glass Reinforced Polyester-Body Glass Reinforced Polyester-Insert Mold</p> <p>Flammability UL 94V-0</p> <p>Plating Underplating: 80 µ" [2.00 µm] Nickel Wiping Area: 30 µ" [0.76 µm] Minimum Gold</p>	<p>Current Rating: 1 A Temperature Rating: -20°C to +85°C</p>
<p>MDR Connectors, 68-Position BM SCSI Footprint Series 102</p> 	<ul style="list-style-type: none"> • RoHS Compliant • Reverse Pin Layout — SCSI-2 Board Compatible • Proven Reliability of the MDR Ribbon Contact Interface 	<p>Contact Material: Copper Alloy</p> <p>Insulation Material: Glass Reinforced Polyester</p> <p>Flammability UL 94V-0</p> <p>Plating Underplating: 80 µ" [2.03 µm] Nickel Wiping Area: 30 µ" [0.76 µm] Minimum Gold</p>	<p>Current Rating: 1 A Temperature Rating: -55°C to +105°C</p>
<p>MDR Connectors, 1S10 Series 102</p>  <p>NEW</p>	<ul style="list-style-type: none"> • RoHS Compliant • Rugged Die Cast Body Resists Tipping During Automated Soldering Operations • Wiper-On-Wiper Contact for Reliable Repetitive Plugging • Ultra-Low Signal Skew for High Data Rate Transmission • Interface Latch Design for Connection Stability • Suitable for Thumbscrew Attach (See TS-0142 for Available Hardware) • MDR Digital LCD Interface as a 20 or 26 Contact Connector • Camera Link® Interface as a 26 Contact Connector • Contact: 14, 20, 26, 40 and 50 	<p>Contact Material: Copper Alloy Body Material: Glass Reinforced Polyester (PCT)</p> <p>Flammability UL 94V-0</p> <p>Plating Underplating: 80 µ" [2.00 µm] Nickel Wiping Area Plating: See Ordering Information</p>	<p>Current Rating: 1 A Temperature Rating: -55°C to +85°C</p>

3M™ INPUT/OUTPUT CONNECTOR & CABLE ASSEMBLY SOLUTIONS MINI DELTA RIBBON (MDR)

PRODUCT	FEATURES	MATERIALS	PERFORMANCE
<p>MDR Cable Assemblies, Power Over Camera Link® Series 1SXXX, 1MXXX</p>  <p>NEW</p>	<ul style="list-style-type: none"> • RoHS Compliant • 3M Is One of the Recognized Leaders in Camera Link® Connectivity • Supports Base Configuration Power over Camera Link® Applications • Straight or Right Angle Cable Exit • Flexible Cable Options Available for Moving Head Applications • SDR-to-SDR and SDR-to-MDR Configurations Available for Cross-Platform Use 	<p>Materials Vary for Connectors, Cables, Shells and Jackscrews. See Website for Specifics.</p>	<p>Current Rating: 0.5 A Temperature Rating: 0°C to +75°C</p>
<p>MDR Cable Assemblies, Round Cable, Input/Output Series 14XXX, 4926, 4120</p> 	<ul style="list-style-type: none"> • RoHS Compliant Pending on Some Versions • 14-100 Positions • .050" Pitch Ribbon Style Contact Provides Reliable Mating and Is Industry Preferred • Compatible for a Variety of LVDS, IEEE 1284, PanelLink™/ TMDS, Flat Link™, and Channel Link™, OpenLDI and QuadLDI Applications • Mates with Standard 3M MDR Boardmount Products • Unshielded or Shielded Twisted Pair or Twinax Cable Options • Contact 3M for Custom Configurations 	<p>Materials Vary for Connectors, Cables, Shells and Jackscrews. See Website for Specifics.</p>	<p>Current Rating: 1 A Temperature Rating: -20°C to +75°C</p>
<p>MDR Cable Assemblies, Camera Link® Series 1XX26</p> 	<ul style="list-style-type: none"> • RoHS Compliant • 3M Is One of the Recognized Leaders in Camera Link® Connectivity • Versions Available to Support Base, Medium and Full Configuration Camera Link® Applications • Straight or Right Angle Cable Exit • Flexible Cable Options Available for Moving Head Applications • Extension Cables for Bulkhead/Feed-Through 	<p>Materials Vary for Connectors, Cables, Shells and Jackscrews. See Website for Specifics.</p>	<p>Performance Varies by Type. See Tech Sheets.</p>
<p>MDR Pleated Foil Input/Output Cable Assemblies Series OM, LS</p> 	<ul style="list-style-type: none"> • RoHS Compliant • Offers Superior Combination of High-Density, Electrical Performance, Shielding and Durability • Allows Digital Data Rates of up to 200 Megabits Per Second Per Conductor • Mates with Standard 3M MDR Boardmount Connectors • Pleated Copper Foil Provides 360 Degree Shield and Allows Coax-Like Performance • Overmolded and Metal with Latching and Thumbscrew Shells Available • Position Sizes from 20-100 	<p>Materials Vary for Connectors, Cables, Shells and Jackscrews. See Website for Specifics.</p>	<p>Temperature Rating: 75°C Maximum</p>

3M™ INPUT/OUTPUT CONNECTOR AND CABLE ASSEMBLY SOLUTIONS

PRODUCT	FEATURES	MATERIALS	PERFORMANCE
<p>Shrunk Delta Ribbon (SDR) Boardmount Receptacles Series 122XX</p> 	<ul style="list-style-type: none"> • RoHS Compliant • 14-50 Positions • Wiper-on-Wiper Contact for Reliable Repetitive Mating • Ground Lock for Reliable PCB Retention • Full Metal Face for Better EMI Shielding Effectiveness • On-Board Jacksockets Maintains a Secure Connection <p>OPTIONS</p> <ul style="list-style-type: none"> • Surfacemount and Through-Hole • Right Angle and Vertical • Panel and Board Lock Hardware • Mini Camera Link® Interface as a 26 Contact Connector 	<p>Contact Phosphor Bronze</p> <p>Insulation Glass Reinforced Polyester</p> <p>Flammability UL 94V-0</p> <p>Plating Underplating: 80 µ" [2.00 µm] Nickel Wiping Area: 30 µ" [0.76 µm] Gold</p>	<p>Current Rating: 0.5 A Temperature Rating: -40°C to +70°C</p>
<p>Shrunk Delta Ribbon (SDR) Cable Assemblies, .80 mm, Mini Camera Link® Series 1MG, 1MF, 1SF</p> 	<ul style="list-style-type: none"> • RoHS Compliant • Supplied as a Complete Assembly Only • Supports New AIA Industrial Camera Link® Standard for Mini C/L Camera to C/L Frame Grabber Applications • 11 Shielded Twisted Twinax Pairs with Four Drain Wires • Double Overall Shield with Foil and Outer Braid EMI Shielded Cable Assembly • Straight and Right Angle Configurations Available • SDR-to-SDR and MDR-to-SDR Options Available • Mates with 3M SDR and MDR Boardmount Products 	<p>Material Varies for Connectors, Cables, Shells and Jackscrews. See Website for Specifics.</p>	<p>Current Rating: 0.5 A Temperature Rating: 0°C to 70°C</p>
<p>Shielded Compact Ribbon (SCR) Connectors Series 361, 362, 363</p> 	<ul style="list-style-type: none"> • RoHS Compliant • Robust, Vibration Resistant Connection • Up to 1A per Pin (Signal or Power) • 10 Pin Plug/Receptacle • Solder Termination — No Tooling Required • EMI Shielded • Multiple Boardmount and Wiremount Configurations for Design Flexibility 	<p>Contact Material: Copper Alloy or Phosphor Bronze</p> <p>Insulation Material: Glass Reinforced LCP or Nylon</p> <p>Flammability UL 94V-0</p> <p>Plating Underplating: Nickel Wiping Area: See Ordering Information Termination Area: See Ordering Information</p>	<p>Current Rating: 1 A Temperature Rating: -55°C to +85°C</p>
<p>I/O Connectors, IEEE 1394 Compatible, 2.0 mm Series 3E</p> <p>NEW</p> 	<ul style="list-style-type: none"> • RoHS Compliant • Compatible with Popular IEEE 1394 I/O Interconnect Standard • Robust, Vibration Resistant Connection with Secure Latching System • Up to 1A per Pin (Signal or Power) • 6 Pin Plug/Receptacle • Solder Termination — No Tooling Required • EMI Shielded 	<p>Contact Material: Copper Alloy</p> <p>Insulation Material: Glass Filled Polyester</p> <p>Flammability UL 94V-0</p> <p>Plating Underplating: 50µ" - 100 µ" [1.27 µm - 2.54 µm] Nickel Wiping Area: 30 µ" [0.76 µm] Gold Termination Area: See Ordering Information</p>	<p>Current Rating: 1 A Temperature Rating: -20°C to +85°C</p>

3M™ INPUT/OUTPUT CONNECTOR AND CABLE ASSEMBLY SOLUTIONS

PRODUCT	FEATURES	MATERIALS	PERFORMANCE
<p>D Sub Plugs IDC Mass Terminated Series 8200</p> 	<ul style="list-style-type: none"> • RoHS Compliant • 9-50 Positions • Available in Either Open or Closed-End Cover • Shell Dimples to Aid in EMI/ESD Protection • Metal Strain Relief Hooks Directly to Metal Shell • Low Profile • Open (Except 50) or Threaded (SAE or Metric) Mounting Holes <p>OPTIONS</p> <ul style="list-style-type: none"> • Mounting Hardware • Open and Closed-End Covers 	<p>Contact Material: Copper Alloy</p> <p>Insulation Material: Glass Reinforced Polyester</p> <p>Flammability UL 94V-0</p> <p>Plating Underplating: 100 μ" [2.54 μm] Nickel Wiping Area: 30 μ" [0.76 μm] Gold</p>	<p>Current Rating: 1 A Temperature Rating: -55°C to +105°C</p>
<p>D Sub Receptacles IDC Mass Terminated Series 8300</p> 	<ul style="list-style-type: none"> • RoHS Compliant • 9-50 Positions • Available in Either Open or Closed-End Cover • Metal Strain Relief — Hooks Directly to Metal Shell • Low Profile • Open (Except 50) or Threaded (SAE or Metric) Mounting Holes <p>OPTIONS</p> <ul style="list-style-type: none"> • Mounting Hardware • Open and Closed-End Covers 	<p>Contact Material: Copper Alloy</p> <p>Insulation Material: Glass Filled Polyester</p> <p>Flammability UL 94V-0</p> <p>Plating Underplating: 100 μ" [2.54 μm] Nickel Wiping Area: 30 μ" [0.76 μm] Gold</p>	<p>Current Rating: 1 A Temperature Rating: -55°C to +105°C</p>
<p>D Sub - Junction Shell Round Cable, Metal Series 3357</p> 	<ul style="list-style-type: none"> • RoHS Compliant • Provides EMI/ESD Protection Similar to Aluminum Die Cast • Easy Assembly Reduces Time and Labor to Ensure Low Applied Cost • Optional Thumbscrew Kit • Provides Option in Grounding for Discrete Wire Applications • Lightweight, Compact Design <p>OPTIONS</p> <ul style="list-style-type: none"> • Thumbscrew Kit • Retainer Rings 	<p>Cover Nut Material: Glass Filled Polyester</p> <p>Shell and Hardware Material: Steel</p> <p>Flammability UL 94V-0</p> <p>Plating Nickel</p>	
<p>D Sub - Junction Shells Round Cable, Plastic Series 3357</p> 	<ul style="list-style-type: none"> • RoHS Compliant • Protection from EMI/ESD • Easy Assembly Reduces Time and Labor for Low Cost • Lightweight and a Compact Design • Strain Relief Compensates for Multiple Cable Diameters • Jackscrews Provide Positive Retention <p>OPTIONS</p> <ul style="list-style-type: none"> • 60 Degree Relief Cable Exits 	<p>Shell and Hardware Shell Material: ABS</p> <p>Insulation Material: Thermoplastic Elastomer</p> <p>Flammability UL 94V0</p> <p>Plating Bright Zinc</p>	<p>Temperature Rating: 0°C to +75°C</p>
<p>D Sub - Junction Shells Flat Cable Series 3485</p> 	<ul style="list-style-type: none"> • RoHS Compliant • Uses Standard Hardware • Lightweight, Compact Size • Full Family of Sizes <p>OPTIONS</p> <ul style="list-style-type: none"> • EMI Versions Available 	<p>Shell Material: Glass Filled Polyester</p> <p>Flammability UL 94V-0</p>	<p>Temperature Rating: -55°C to +105°C</p>

3M™ CABLE SOLUTIONS

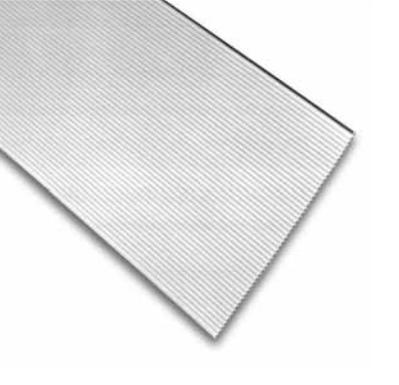
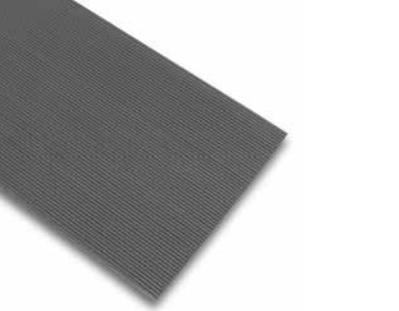
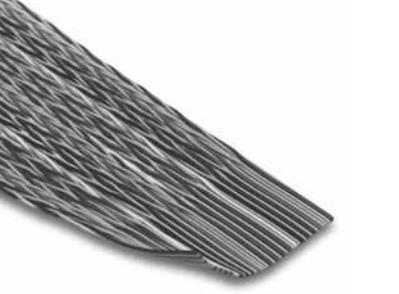
PRODUCT	FEATURES	MATERIALS	PERFORMANCE
<p>Round Conductor Flat Cable Series 3365, 3355, 2010, 3601</p> 	<ul style="list-style-type: none"> • RoHS Compliant • 28 AWG Wire on .050 Inch Centers Permits Mass Termination to a Broad Line of IDC Connectors • Stranded Wire Provides Flexibility and Extended Product Life • Zippable for Branching or Discrete Termination • Series 3365 Available in Gray or Black • 2010 Is Halogen Free <p>OPTIONS</p> <ul style="list-style-type: none"> • .025", .033", .050", 1 mm, .100" and .156" Center Line • 18, 22, 24, 26, 28 and 30 AWG Conductors • Solid and Stranded Conductors • Multiple Roll Lengths • UL/CSA Marking Line • PVC Jacket Options • Split Sections • For Other Variations, See Website 	<p>Insulation Material: Polyvinyl Chloride TPE, FEP, PO Insulators</p>	<p>Flammability USA: VW-1 Canada: FT-1 Temperature Rating: -20°C to +105°C Voltage: USA 300V, Canada: 150V, EU: <50V</p>
<p>Extended Flex Life - Flat Cable Series 3319, 3539</p> 	<ul style="list-style-type: none"> • RoHS Compliant • Flex Life of 100 Million Cycles at 1 3/4 Inch Diameter • High Strength Copper Alloy Provide the Longest Flex Life Available for Dynamic Applications • 28 AWG Wire on .050 Inch Wire Spacing Permits Mass Termination to a Broad Line of IDC Connectors • Zippable for Branching or Discrete Termination <p>OPTIONS</p> <ul style="list-style-type: none"> • High Flex • Medium Flex 	<p>Insulation Material: Polyvinyl Chloride</p>	<p>Flammability USA: VW-1, Canada FT-1 Temperature Rating: -20°C to +105°C Voltage: USA 300V, Canada: 150V, EU: <50V</p>
<p>Twisted Pair Flat Cable Series 1700, 2100, 3782</p> 	<ul style="list-style-type: none"> • RoHS Compliant • Wires Are Color-Coded for Easy Identification • Twist and Flat Repeat Has Variable Length Option • Can Be Mass Terminated to a Broad Line of IDC Connectors • Provides Reduced Crosstalk in Balanced Drive Applications • 28 AWG Stranded Wire Provides Flexibility and Extended Product Life • 10-Color Repeat • 2100 Is Halogen Free <p>OPTIONS</p> <ul style="list-style-type: none"> • Variable Twist and Flat Repeat Lengths 	<p>Insulation Material: Polyvinyl Chloride or PO Insulators</p>	<p>Flammability USA: VW-1 Canada: FT-1 Temperature Rating: USA: -20°C to +105°C Canada: -20°C to +80°C Voltage: USA 300V, Canada: 150V, EU: <50V</p>
<p>Round Jacketed Flat Cable Series 3659, 3759, 3758, 3896</p> 	<ul style="list-style-type: none"> • RoHS Compliant • Round Construction Permits Easier Routing • 28 AWG Wire on .050 Inch Pitch Permits Mass Termination to Broad Line of IDC Connectors • Continuous Split/Bond Repeat Allows for Mass Termination on 2.4 Inch Centers (Approximate) • Primary Cable Is Zippable for Branching or Discrete Terminations • Meets External Wiring Requirements of National Electrical Code, Article 725 (CL2) • UL Listed for USA and Canadian Markets • Dual Shielding Provides 35 db Average Shielding Effectiveness <p>OPTIONS</p> <ul style="list-style-type: none"> • .025", .050" Centerline • 26, 28 and 30 AWG Conductors • Solid and Stranded Conductors • Shielded and Non-Shielded Versions 	<p>Jacket Material: Polyvinyl Chloride or PO Insulators</p>	<p>Flammability USA: N.E.C. 725, CL2 Canada: FT-1 Temperature Rating: USA: CL2; 75°C Max or AWM; -20°C to +80°C, Canada: 80°C Voltage: USA 300V, Canada: 150V, EU: <50V</p>

3M™ CABLE SOLUTIONS

PRODUCT	FEATURES	MATERIALS	PERFORMANCE
<p>Color Coded Flat Cable Series 3302, 3811</p> 	<ul style="list-style-type: none"> • RoHS Compliant • 28 AWG Wire on .050 Inch Centers Permits Mass Termination to a Broad Line of IDC Connectors • Stranded Wire Provides Flexibility and Extended Product Life • Zippable for Branching or Discrete Termination Color Coded for Wire Identification <p>OPTIONS</p> <ul style="list-style-type: none"> • 22, 26 and 28 AWG Conductors • 100", .156" Centerline 	<p>Insulation Material: Polyvinyl Chloride</p>	<p>Flammability USA: VW-1 Canada: FT-1 Temperature Rating: USA: -20°C to +105°C Canada: -20°C to + 80°C Voltage: USA 300V, Canada: 150V, EU: <50V</p>
<p>Round Jacketed Discrete Twisted Pair Cable Series 3600, 3644</p> 	<ul style="list-style-type: none"> • RoHS Compliant • Meets External Wiring Requirements of National Electrical Code, Article 725 (CL2) • 28 AWG Stranded Wire Provides Flexibility • Twisted Pairs Reduce Crosstalk for Balanced Drive Applications • Dual Shielding with Aluminum Film Foil and Copper Braid Provides Excellent EMI/ESD Protection • Wires Are Color-Coded for Easy Identification • 35 db Average Shielding Effectiveness <p>OPTIONS</p> <ul style="list-style-type: none"> • 26 and 28 AWG Conductors 	<p>Jacket Material: Polyvinyl Chloride and PO Insulators and Jacket</p>	<p>Flammability USA: N.E.C.725, CL2 Canada: FT-1 Temperature Rating: USA: CL2 75°C Max, Canada: 80°C Voltage: USA 300V, Canada: 150V, EU: <50V</p>
<p>Pleated Foil Flat Cable Series 901XX, 902XX, 931XX</p> 	<ul style="list-style-type: none"> • RoHS Compliant • Compatible with IDC Mass Termination Connectors • Functions with Applications Requiring Standard Impedance of 100Ω Balanced (Differential) • Extremely Low Crosstalk, Used in the All-Signal Mode to Quadruple Signal Density as Compared to Standard .050 Inch Flat Ribbon Cable • Solid Pleated Copper Foil Provides Flexibility and 35 db Average Shielding Effectiveness • CL2 Rated, Rugged Design and High Reliability for Peripheral Applications <p>OPTIONS</p> <ul style="list-style-type: none"> • .025" and .050" Centerline • 28 and 30 AWG Conductors • Solid and Stranded Conductors • Thick and Thin Jacket Options • Low Skew Versions 	<p>Jacket Material: TPE with PVC and TPE Jacketing Materials</p>	<p>Flammability USA: N.E.C. 725, CL2, Canada: FT-1 Temperature Rating: USA: CL2: 75°C; Canada: 80°C Voltage: USA 300V, Canada: 150V, EU: <50V</p>

3M™ CABLE ASSEMBLY SOLUTIONS

PRODUCT	FEATURES	MATERIALS	PERFORMANCE
<p>Molded Flat Ribbon Assemblies Series 87, 1M and 2M</p> 	<ul style="list-style-type: none"> • RoHS Compliant • 10-60 Positions • Two-Piece with Adhesive Cover for Daisy Chain or Round-to-Flat Cable Applications • Plastic or Metal Strain Relief Option • Positive Locking Metal Clip for High Cover Retention • Open or Closed-End Covers 	<p>Contact Material: Copper Alloy</p> <p>Insulation Material: Glass Filled Polyester</p> <p>Plating Underplating and U-Slot: 100 μ" [2.54 μm] Nickel Wiping Area: 30 μ" [0.76 μm] Gold</p>	<p>Current Rating: 1 A Temperature Rating: -55°C to +105°C</p>
<p>Mini Delta Ribbon (MDR) Cable Assemblies, Round Cable, Input/Output Series 14XXX, 4926, 4120</p> 	<ul style="list-style-type: none"> • RoHS Compliant • Pre-Assembled for High Efficiency • Pre-Assembled, Terminates Faster Than Two-Piece Sockets "Sword" Packaging Makes Easy Loading of Manual and Semi-Automatic Assembly Equipment • "Bumps" Prevent Premature Latch Locking During Shipment • Military Polarization, With or Without Centerbump • Optional Double-Sided Adhesive Pull Tab for Easy Unplugging • Double-Recessed Cover for Cable Terminating from Either Side Virtually Eliminates Need for Single-Recessed Cover Connectors 	<p>Contact Material: Phosphor Bronze</p> <p>Insulation Material: Glass Filled Polyester (PBT) Color: Gray</p> <p>Plating Underplating: 50 μ" [1.27 μm] Nickel Wiping Area: 30 μ" [0.76 μm] or 10 μ" [0.25 μm] Gold Wire Accommodation: 26 and 28 AWG Stranded</p>	<p>Current Rating: 2 A (EIA 364-70) Temperature Rating: -55°C to +105°C</p>
<p>MDR Cable Assemblies, Power over Camera Link® Series 1SXXX, 1MXXX</p> 	<ul style="list-style-type: none"> • RoHS Compliant • 3M Is One of the Recognized Leaders in Camera Link® Connectivity • Supports Base Configuration Power over Camera Link® Applications • Straight or Right Angle Cable Exit • Flexible Cable Options Available for Moving Head Applications • SDR-to-SDR and SDR-to-MDR Configurations Available for Cross-Platform Use 	<p>Materials Vary for Connectors, Cables, Shells and Jackscrews. See Website for Specifics.</p>	<p>Current Rating: 0.5 A Temperature Rating: 0°C to +75°C</p>
<p>MDR Cable Assemblies, Camera Link® Series 1XX26</p> 	<ul style="list-style-type: none"> • RoHS Compliant • 3M Is One of the Recognized Leaders in Camera Link® Connectivity • Versions Available to Support Base, Medium and Full Configuration Camera Link® Applications • Straight or Right Angle Cable Exit • Flexible Cable Options Available for Moving Head Applications • Extension Cables for Bulkhead/Feed-Through 	<p>Materials Vary for Connectors, Cables, Shells and Jackscrews. See Website for Specifics.w</p>	<p>Performance Varies by Type. See Tech Sheets.</p>
<p>Mini Delta Ribbon (MDR), Pleated Foil Input/Output Cable Assemblies Series OM, LS, MS</p> 	<ul style="list-style-type: none"> • RoHS Compliant • Offers Superior Combination of High-Density, Electrical Performance, Shielding and Durability • Allows Digital Data Rates of up to 200 Megabits per Second per Conductor • Mates with Standard 3M MDR Boardmount Connectors • Pleated Copper Foil Provides 360 Degree Shield and Enables Coax-Like Performance • Overmolded and Metal with Latching and Thumbscrew Shells Available • Position Sizes from 20-100 	<p>Materials Vary for Connectors, Cables, Shells and Jackscrews. See Website for Specifics.</p>	<p>Temperature Rating: 75°C Maximum</p>

3M™ CABLE ASSEMBLY SOLUTIONS

PRODUCT	FEATURES	MATERIALS	PERFORMANCE
<p>Shrunk Delta Ribbon (SDR) Cable Assemblies, .80 mm, Input/Output Series 1MG, 1MF, 1SF</p> 	<ul style="list-style-type: none"> • RoHS Compliant • Supplied as a Complete Assembly Only • Supports New AIA Industrial Camera Link® Standard for Mini C/L Camera to C/L Frame Grabber Applications • 11 Shielded Twisted Twinax Pairs with Four Drain Wires • Double Overall Shield with Foil and Outer Braid EMI Shielded Cable Assembly • Straight and Right Angle Configurations Available • SDR-to-SDR and MDR-to-SDR Options Available • Mates with 3M SDR and MDR Boardmount Products 	<p>Insulation Material: Polyvinyl Chloride</p> <p>Plating Underplating: 100 μ" [2.55 μm] Nickel Wiping Area: 30 μ" [0.76 μm] Minimum Gold Materials Vary for Connectors, Cables, Shells and Jackscrews. See Website for Specifics.</p>	<p>Current Rating: 1 A Temperature Rating: -20°C to +85°C</p>
<p>Serial Advanced Technology Attachment (SATA) Power Cable Series 5601</p> 	<ul style="list-style-type: none"> • RoHS Compliant • 15-Position Power Cable • Rugged Over-Molded Construction Provided in Standard Lengths • "Y" Type Supports Multiple Devices 	<p>Insulation Material: High Temperature Thermoplastic</p> <p>Plating Wiping Area: 30 μ" [0.76 μm] Gold Solder Tails: 100 μ" [2.54 μm] Tin Underplating: 50 μ" [1.27 μm] Nickel</p>	<p>Current Rating: 1 A Temperature Rating: -20°C to +85°C</p>
<p>Serial Advanced Technology Attachment (SATA) Signal Cable Series 5602</p> 	<ul style="list-style-type: none"> • RoHS Compliant • 7-Position Serial Signal Assembly • Multiple Variations in Length and Interface Attachments • Point-to-Point Signaling • Polarized Interface Ensures Proper Alignment • 26 AWG Differential Pairs • Meets SATA 2.6 Specification 	<p>Insulation Material: High Temperature Thermoplastic</p> <p>Plating Wiping Area: 30 μ" [0.76 μm] Gold Solder Tails: 100 μ" [2.54 μm] Tin Underplating: 50 μ" [1.27 μm] Nickel</p>	<p>Current Rating: 1 A Temperature Rating: -20°C to +85°C</p>

3M™ CABLE ASSEMBLY SOLUTIONS

PRODUCT	FEATURES	MATERIALS	PERFORMANCE
<p data-bbox="45 205 337 289">Mini Serial Attached SCSI (miniSAS) Cable Assembly, Series 8N36</p> 	<ul data-bbox="462 205 706 378" style="list-style-type: none"> • RoHS Compliant • 6 Gbps per Channel Data Rate • 36 Conductor Signal Assembly • Custom Lengths Available • Metal Latch • 30 AWG Twin Axial Cable • Universal Key • Right Angle Version Available 	<p data-bbox="820 205 1052 273">Materials Vary for Connectors, Cables, Shells and Jackscrews. See Website for Specifics.</p>	<p data-bbox="1177 205 1458 252">Current Rating: 0.5 A Temperature Rating: -20°C to +80°C</p>
<p data-bbox="45 1108 337 1192">Mini Serial Attached SCSI (miniSAS) Cable Assembly, Series 8M26</p> 	<ul data-bbox="462 1108 755 1323" style="list-style-type: none"> • RoHS Compliant • Capable of 6 Gbps Per Channel Data Rate • 26 Conductor Signal Assembly • Multiple Lengths Available • Metal Latch • Pull Tab Ring Provides Easier Unmating • Two Levels of EMLB for Hot Plugging • Multiple Key Options Available 	<p data-bbox="820 1108 1112 1491"> Connector Backshell Material: Zinc Diecast Plating 30 µ" [0.76 µm] Nickel Contact PCB Material: FR4 Underplating: 50 µ" [1.27 µm] Nickel Wiping Area: 30 µ" [0.76 µm] Gold Cable Conductor: Tin Plated Solid Conductor (AWG Depends on Length) Drain Wire: Tin Plated Solid Conductor Dielectric: Foam Polyethylene Shield: Mylar Jacket: Non-PVC Pulltab Material: Nylon Color: Blue </p>	<p data-bbox="1177 1108 1461 1176">Current Rating: Per Contact: 0.5 A Operating Temperature: -20°C to +75°C</p>

3M™ CABLE ASSEMBLY SOLUTIONS HIGH SPEED ASSEMBLIES

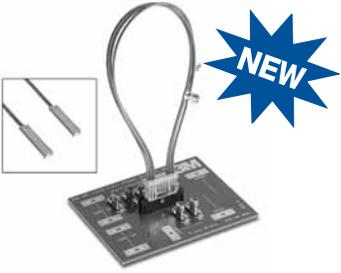
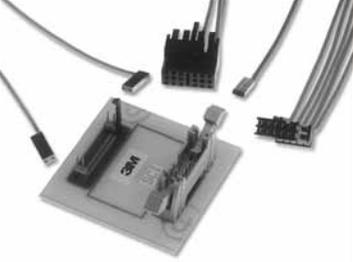
PRODUCT	FEATURES	MATERIALS	PERFORMANCE
SCI Latch/Eject 2 mm Development Kit 	<ul style="list-style-type: none"> • 1 Gbps Single-Ended, 5 Gbps Differential or Mix and Match Cable-to-Board Solution • Robust Latching for Mechanically Challenging Environments • Low Crosstalk and Skew • Upgrade to Higher Speed and Better Crosstalk for Molded and IDC Cable Assemblies • High Density – 2 mm Pitch – Upgrade from 0.100" • Vertical SMT and Through-Hole Options Available 	Material Varies for Connectors and Cables. See Website for Specifics.	1 Gbps Single-Ended, 5 Gbps Differential
Shielded Controlled Impedance (SCI) Assemblies High Speed Series 98 	<ul style="list-style-type: none"> • RoHS Compliant Version Available • Robust Metal Grounded Connectors Provide EMI Shielding and Controlled Impedance for Industry Leading Signal Integrity and Performance • Various Carrier Types and Sizes for .100" 2 mm SCI Connectors 		
SCI Cable Assembly, .100" 	<ul style="list-style-type: none"> • .100" (2.54 mm) Center Spacing • Available in Stand-Alone and Carrier Versions <p>Stand-Alone Version</p> <ul style="list-style-type: none"> • Available in Right Angle and Straight Configurations • Mates with 3M Two-pin Headers <p>Carrier Version</p> <ul style="list-style-type: none"> • Available in Straight Configuration Designed for Use with the 3M SCI Carrier System • Mates with .100" x .100" Headers • Carriers May Be Purchased Separately • Up to 3 Gbps Performance 	<p>Contact Material: Beryllium Copper</p> <p>Insulation Material: Thermoplastic</p>	<p>Current Rating: 1 A</p> <p>Temperature Rating: -55°C to +105°C</p>
SCI Cable Assembly, 2 mm 	<ul style="list-style-type: none"> • High Density 2.0 mm Center Spacing • Available in Carrier Versions Only • Mates with Compact PCI®, HSHM, Futurebus® and 3M™ Pin Strip Headers, 1512 Series • Provides over 12 Gbps Performance • Available with High Performance Coaxial or Twinaxial Cables • Available With or Without External Ground Clips 	<p>Contact Material: Beryllium Copper</p> <p>Insulation Material: Thermoplastic</p>	<p>Bandwidth: Rated for Applications Requiring up to 12 Gbps Performance</p> <p>Current Rating: 1 A</p> <p>Temperature Rating: -40°C to +105°C</p>
Custom Harness Assemblies 	<ul style="list-style-type: none"> • Available with 0.100" and 2 mm SCI • Double-Ended SCI with Carrier or Optional Spring Probe Termination • Controlled Impedance Through the Interface to Provide Minimal Reflections • Low-loss, Low Crosstalk and Low Skew to Provide Industry Leading Eye Openings and Performance • Available in Differential or Coaxial Cable Configurations • Contact 3M for Custom Configurations <p>0.100" Harness Assemblies</p> <ul style="list-style-type: none"> • Compatible with Standard .100" x .100" Headers • Standard Carriers Available <p>2 mm Harness Assemblies</p> <ul style="list-style-type: none"> • Compatible with CompactPCI®, HSHM, Futurebus® and 3M™ Pin Strip Headers, 1512 Series • Industry Leading Signal Density of up to 101 Signals per Linear Inch • Surfacemount 3-Wall Header Available 		



Build Cable Assembly | Retrieve Cable Assembly

Virtual Cable Assembly Tool (VCAT)

[Contact Us](#) | [Help](#)

Get Started Now!

Training & Quick Reference Guide

It's Fast...
Innovative
& Always Available



Features: Retrieve Assemblies

Available 3M™ Cable Assembly Types:

- Mini Delta Ribbon (MDR)
- Micro Coaxial
- Monosignal (Mini Coaxial)
- Molded Flat Ribbon, .100" and 2 mm
- Mini Serial Attached SCSI (miniSAS)
- Pleated Foil Covered (PFC)
- Serial Advanced Technology Attachment (SATA)
- Serial Attached SCSI (SAS)
- Shielded Controlled Impedance (SCI)
- SCSI and Shrunk Delta Ribbon (SDR)

[Legal Information](#) | [Privacy Policy](#)

© 3M 2008. All Rights Reserved.

Interconnect Website: The destination for component engineers and designers.

Our entire website has been redesigned to enhance your experience:

- Search by part number
- Configure a part
- Check distributor inventory
- Request samples or quotes
- Build and configure cable assemblies using our Virtual Cable Assembly Tool (VCAT)
- Find cables using our parametric product selector



RoHS Compliant Statement

“RoHS Compliant 2005/95/EC” means that the product or part (“Product”) does not contain any of the substances in excess of the maximum concentration values in EU Directive 2002/95/EC, as amended by Commission Decision 2005/618/EC, unless the substance is in an application that is exempt under EU RoHS. This information represents 3M’s knowledge and belief, which may be based in whole or in part on information provided by third party suppliers to 3M.

In the event any Product is proven not to conform with 3M’s RoHS claim, then 3M’s entire liability and Buyer’s exclusive remedy, will be at 3M’s option either: (i) replacement of Product with a conforming product, or (ii) refund of the purchase price paid by Buyer for each non-conforming Product, within a reasonable time after written notification of said non-conformance and return of said Product to 3M. 3M shall not under any circumstances be liable for direct, incidental, special, or consequential damages (including but not limited to loss of profits, revenue, or business) related to or arising out of this certification, including, the use, misuse or inability to use the Product. Unless stated otherwise in writing, the foregoing language cannot be waived, modified, or supplemented in any manner whatsoever.

“RoHS Compliant” does not imply high temperature. Please refer to the specifications to determine suitability for processing.

Backwards Compatibility

3M Electronic Solutions Division RoHS compliant products have been tested for solderability per J-STD-002 using iNEMI recommended Sn-Cu and Sn-Ag-Cu solders as well as eutectic Sn-Pb solders. Based on this test standard, acceptable solderability has been achieved with all solders tested. RoHS compliant products will solder with Sn-Pb solders. Before using this product in any tin-lead solder processes, you must evaluate the product in your process and determine if it is suitable for your process. You assume all risks and liability associated with such use. It is NOT advisable to “drop in” RoHS compliant products to current tin-lead solder processes without proper evaluation. It may be advisable to perform pilot runs with the RoHS compliant product to assure that the process achieves a good solder joint without process modification or adjustment. Some process adjustment may be necessary.



Camera Link is a certification mark of Automated Imaging Association.

Channel Link is a trademark of National Semiconductor.

CompactFlash is a trademark of SanDisk Corporation.

CompactPCI is a trademark of PICMG-PCI Industrial Computer Manufacturers Group, Inc.

FlatLink is a trademark of Texas Instruments.

Futurebus and Futurebus+ are trademarks of the Institute of Electrical and Electronic Engineers, Inc. (IEEE)

PanelLink is a trademark of Silicon Image, Inc.

Winzip is a trademark of Winzip Computing, Inc.

3M and MetPak are trademarks of 3M Company.

Important Notice

Before using this product, you must evaluate it and determine if it is suitable for your intended application. You assume all risks and liability associated with such use.

Warranty; Limited Remedy; Limited Liability.

3M's product warranty is stated in its Product Literature available upon request. **3M MAKES NO OTHER WARRANTIES INCLUDING, BUT NOT LIMITED TO, ANY IMPLIED WARRANTY OF MERCHANTABILITY OR FITNESS FOR A PARTICULAR PURPOSE.** If this product is defective within the warranty period stated above, your exclusive remedy shall be, at 3M's option, to replace or repair the 3M product or refund the purchase price of the 3M product. Except where prohibited by law, 3M will not be liable for any loss or damage arising from this 3M product, whether indirect, special, incidental or consequential regardless of the legal theory asserted.



**Electronic Solutions Division
Interconnect Products**

6801 River Place Blvd.
Austin, TX 78726-9000
USA
800/225-5373
3M.com/interconnects

Please recycle. Printed in USA.
© 3M 2008. All rights reserved.
80-4000-1985-9 (120840) K/G-1



Компания «ЭлектроПласт» предлагает заключение долгосрочных отношений при поставках импортных электронных компонентов на взаимовыгодных условиях!

Наши преимущества:

- Оперативные поставки широкого спектра электронных компонентов отечественного и импортного производства напрямую от производителей и с крупнейших мировых складов;
- Поставка более 17-ти миллионов наименований электронных компонентов;
- Поставка сложных, дефицитных, либо снятых с производства позиций;
- Оперативные сроки поставки под заказ (от 5 рабочих дней);
- Экспресс доставка в любую точку России;
- Техническая поддержка проекта, помощь в подборе аналогов, поставка прототипов;
- Система менеджмента качества сертифицирована по Международному стандарту ISO 9001;
- Лицензия ФСБ на осуществление работ с использованием сведений, составляющих государственную тайну;
- Поставка специализированных компонентов (Xilinx, Altera, Analog Devices, Intersil, Interpoint, Microsemi, Aeroflex, Peregrine, Syfer, Eurofarad, Texas Instrument, Miteq, Cobham, E2V, MA-COM, Hittite, Mini-Circuits, General Dynamics и др.);

Помимо этого, одним из направлений компании «ЭлектроПласт» является направление «Источники питания». Мы предлагаем Вам помощь Конструкторского отдела:

- Подбор оптимального решения, техническое обоснование при выборе компонента;
- Подбор аналогов;
- Консультации по применению компонента;
- Поставка образцов и прототипов;
- Техническая поддержка проекта;
- Защита от снятия компонента с производства.



Как с нами связаться

Телефон: 8 (812) 309 58 32 (многоканальный)

Факс: 8 (812) 320-02-42

Электронная почта: org@eplast1.ru

Адрес: 198099, г. Санкт-Петербург, ул. Калинина, дом 2, корпус 4, литера А.