

DWG. NO.

SA94843

# RBGT GROUNDING & RBMT MOUNTING TRACKS

THIS DRAWING IS A CONTROLLED DOCUMENT FOR SOURIAU USA, INC.  
IT IS SUBJECT TO CHANGE WITHOUT NOTIFICATION.  
CONTACT THE DOCUMENT CONTROL CENTER FOR THE LATEST REVISION.

PRO-E

THE INFORMATION CONTAINED IN THIS DRAWING IS CONFIDENTIAL AND MAY NOT BE  
DISCLOSED WITHOUT WRITTEN CONSENT FROM SOURIAU USA, INC.

SUPERSEDES: SE94843-5

REV	DESCRIPTION	BY DATE	CHKD DATE
U	REVISED PER ECN 12047	RSK 10-09-13	SDH 10-09-13
T	REVISED PER ECN 11710	RSK 05-02-12	SDH 05-02-12
S	REVISED PER ECN 11271	VKP 11-15-10	SDH 11-15-10
R	REVISED PER ECN 7622	JRD 09-20-02	SDH 09-20-02

DRAWING TITLE

**TRACKS, GROUNDING & MOUNTING**

LINEAR MEASURE:  INCH [mm]

CAT NO. **RBGT \_ & RBMT \_ (SEE TABLE, SHT. 2)**

THIRD ANGLE PROJECTION

CAGE NO.: 09922

SIZE: A



APPROVAL

DRAWN:	VKP	11-15-10
CHKD :	SDH	11-15-10
DSGN :	JDA	10-13-92
MFG :	DH	11-15-10
QC :	DK	11-15-10

**CUSTOMER**

**SOURIAU**

DRAWING SCALE: 1:1  
DRAWING NO. REV

No. OF PLACES	INCH [mm]
ONE PLACE	±.1 [±3]
TWO PLACES	±.02 [±0.5]
THREE PLACES	±.010 [±0.25]
ANGLES ±1°	

INTERPRET THIS DRAWING IN ACCORDANCE WITH ASME Y14.5M - 1994.

[www.souriau.com](http://www.souriau.com)

SA94843 U

1 OF 6

DWG. NO.  
SA94843

NOTES:

- 1. GROUNDING TRACK ACCOMMODATES PIN CONTACTS PER MIL-C-39029/1-101. WITH A WIRE RANGE OF 24-22-20 AWG. USE INSERTION/REMOVAL TOOL PER MIL-I-81969/14C-11.

MATERIAL:

- STRAIN RELIEF GROMMET: SILICONE RUBBER, COLOR RED
- GROMMET BONDING: EPOXY
- GROUNDING MODULE BODY: GLASS FORTIFIED THERMOPLASTIC UL94V-0. COLOR BLUE
- GROUNDING AND MOUNTING TRACKS: 6063-T6 ALUMINUM
- GROUNDING RIVETS: ALUMINUM ALLOY
- GROUNDING SOCKET CONTACTS: BERYLLIUM COPPER
- CONTACT RETENTION CLIPS: BERYLLIUM COPPER
- SOCKET CONTACT SLEEVES: THERMOPLASTIC, LIQUID CRYSTAL POLYMER
- TERMINAL IDENTIFICATION STRIP: THERMOPLASTIC, UL94V-0, COLOR WHITE
- PROTECTIVE COATING: POLYURETHANE, COLOR OPTIONAL

FINISH:

- GROUNDING AND MOUNTING TRACKS: CHROMATE CONVERSION COATING PER MIL-C-81706, CLASS 3, METHOD C, COLOR GOLD. (REF: ALODINE 1200)
- GROUNDING SOCKET CONTACTS: 50 MICROINCHES [1.27 MICRONS] MIN. NICKEL ALL OVER. PIN CONTACT CURRENT BEARING SURFACE OVER-PLATED WITH 50 MICROINCHES [1.27 MICRONS] MIN. HARD GOLD.

DESCRIPTION TABLE		
SOURIAU CATALOG NO.	(O.A LENGTH)	WEIGHT (g)
RBGT2	2.000 [50.80]	17.5
RBGT4	4.000 [101.60]	35.0
RBGT6	6.000 [152.40]	52.5
RBGT8	8.000 [203.20]	70.0
RBGT10	10.000 [254.00]	87.5
RBGT14	14.000 [355.60]	122.5
RBGT16	16.000 [406.40]	140.0
RBGT18	18.000 [457.20]	157.5
RBGT20	20.000 [508]	175.0
RBGT22	22.000 [558.80]	192.5
RBGT26	26.000 [660.40]	227.5
RBGT28	28.000 [711.20]	245.0
RBGT34	34.000 [863.60]	297.5
RBGT38	38.000 [965.20]	332.5
RBMT2	2.000 [50.80]	6.25
RBMT4	4.000 [101.60]	12.5
RBMT6	6.000 [152.40]	18.75
RBMT8	8.000 [203.20]	25.0
RBMT10	10.000 [254.00]	31.25
RBMT14	14.000 [355.60]	43.75
RBMT16	16.000 [406.40]	50.0
RBMT18	18.000 [457.20]	56.25
RBMT20	20.000 [508]	62.5
RBMT22	22.000 [558.80]	68.75
RBMT26	26.000 [660.40]	81.25
RBMT28	28.000 [711.20]	87.5
RBMT34	34.000 [863.60]	106.25
RBMT38	38.000 [965.20]	118.75

---	ALL REV. RECORDED ON SHT. 1	---	---
REV		BY DATE	CHKD DATE

DRAWING TITLE			
<b>TRACKS, GROUNDING &amp; MOUNTING</b>			
<b>RBGT _ &amp; RBMT _ (SEE TABLE, SHT. 2)</b>			
CAT NO.	SIZE: A	DRAWN: VKP 11-15-10	
CAGE NO.: 09922		CHKD : SDH 11-15-10	
<b>CUSTOMER</b>	<b>SOURIAU</b>	DSGN : JDA 10-13-92	
		MFG : DH 11-15-10	
		QC : DK 11-15-10	
		DRAWING SCALE: 1:1	
		DRAWING NO. REV	
INTERPRET THIS DRAWING IN ACCORDANCE WITH ASME Y14.5M - 1994.		SA94843 U	
<a href="http://www.souriau.com">www.souriau.com</a>		2 OF 6	

LINEAR MEASURE:		INCH [mm]
THIRD ANGLE PROJECTION		
TOLERANCES UNLESS OTHERWISE SPECIFIED		
No. OF PLACES	INCH [mm]	
ONE PLACE	±.1 [±3]	
TWO PLACES	±.02 [±0.5]	
THREE PLACES	±.010 [±0.25]	
ANGLES ±1°		

THIS DRAWING IS A CONTROLLED DOCUMENT FOR SOURIAU USA, INC. IT IS SUBJECT TO CHANGE WITHOUT NOTIFICATION. CONTACT THE DOCUMENT CONTROL CENTER FOR THE LATEST REVISION.

**PRO-E**

THE INFORMATION CONTAINED IN THIS DRAWING IS CONFIDENTIAL AND MAY NOT BE DISCLOSED WITHOUT WRITTEN CONSENT FROM SOURIAU USA, INC.

DWG. NO.

SA94843

# PERFORMANCE CHARACTERISTICS

**ELECTRICAL:**

**CONTACT RESISTANCE:** IN ACCORDANCE WITH MIL-T-81714, PARA. 4.6.16.  
 REF: MIL-STD-1344, METHOD 3004.  
 SIZE 16-20: 45 MILLIVOLTS MAX. AT 7.5A WITH  
 20 AWG SILVER PLATED WIRE.

**LOW LEVEL CONTACT RESISTANCE:** IN ACCORDANCE WITH MIL-T-81714, PARA. 4.6.17.  
 REF: MIL-STD-1344, METHOD 3002.  
 SIZE 16-20: .009 OHMS MAX. WITH  
 20 AWG SILVER PLATED WIRE.

**VOLTAGE STABILITY:** 4 MILLIVOLT MAX. DIFFERENCE BETWEEN RECORDED HIGHEST  
 AND LOWEST POTENTIAL DROP VALUES IN ACCORDANCE WITH  
 MIL-T-81714, PARA. 4.6.18.

**ENVIRONMENTAL:**

**FLUID IMMERSION:** ALL MATERIALS ARE RESISTANT TO BMS3-11 (SKYDROL LD-4) AND  
 MIL-H-5606 HYDRAULIC FLUIDS, AND MIL-L-7808 AND  
 MIL-L-23699 LUBRICATING OILS.

**HUMIDITY:** IN ACCORDANCE WITH MIL-T-81714, PARA. 4.6.10.  
 REF: MIL-STD-1344, METHOD 1002, TYPE II, (EXCEPT WITHOUT  
 STEP 7b)

**SALT SPRAY:** 500 HOURS IN ACCORDANCE WITH MIL-T-81714, PARA. 4.6.12.  
 REF: MIL-STD-1344, METHOD 1001, TEST CONDITION C.

**VIBRATION (SINUSOIDAL):** IN ACCORDANCE WITH MIL-T-81714, PARA. 4.6.8.1.  
 REF: MIL-STD-202, METHOD 204, TEST CONDITION G.

**VIBRATION (RANDOM):** IN ACCORDANCE WITH MIL-T-81714, PARA. 4.6.8.2.  
 REF: MIL-STD-1344, METHOD 2005, TEST CONDITION VI. LETTER J.

**MECHANICAL (IMPACT) SHOCK:** IN ACCORDANCE WITH MIL-T-81714, PARA. 4.6.9.  
 REF: MIL-STD-1344, METHOD 2004, TEST CONDITION D.

**THERMAL SHOCK:** IN ACCORDANCE WITH MIL-T-81714, PARA. 4.6.5.  
 REF: MIL-STD-1344, METHOD 1003, TEST CONDITION A,  
 (EXCEPT TEMPERATURE EXTREMES ARE -65°C TO +150°C  
 [-85°F TO +302°F]).

**TEMPERATURE LIFE:** 150°C [302°F] FOR 1000 HOURS IN ACCORDANCE WITH  
 MIL-T-81714, PARA. 4.6.13.

**OZONE:** IN ACCORDANCE WITH MIL-T-81714, PARA. 4.6.14.  
 REF: MIL-STD-1344, METHOD 1007.

---	ALL REV. RECORDED ON SHT. 1	---	---
REV	DESCRIPTION	BY DATE	CHKD DATE

DRAWING TITLE  
**TRACKS, GROUNDING & MOUNTING**

CAT NO. **RBGT** & **RBMT** (SEE TABLE, SHT. 2)

CAGE NO.: 09922

SIZE: A

APPROVAL	DRAWN: VKP	11-15-10
	CHKD : SDH	11-15-10
	DSGN : JDA	10-13-92
	MFG : DH	11-15-10
	QC : DK	11-15-10

**CUSTOMER**

**SOURIAU**

DRAWING SCALE: 1:1  
 DRAWING NO. REV

SA94843 U

www.souriau.com

3 OF 6

INTERPRET THIS DRAWING IN ACCORDANCE  
 WITH ASME Y14.5M - 1994.

LINEAR MEASURE: INCH [mm]

THIRD ANGLE PROJECTION

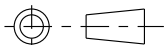

TOLERANCES  
 UNLESS OTHERWISE SPECIFIED

No. OF PLACES	INCH [mm]
ONE PLACE	±.1 [±3]
TWO PLACES	±.02 [±0.5]
THREE PLACES	±.010 [±0.25]
ANGLES ±1°	

THIS DRAWING IS A CONTROLLED DOCUMENT FOR SOURIAU USA, INC. IT IS SUBJECT TO CHANGE WITHOUT NOTIFICATION. CONTACT THE DOCUMENT CONTROL CENTER FOR THE LATEST REVISION.

**PRO-E**

THE INFORMATION CONTAINED IN THIS DRAWING IS CONFIDENTIAL AND MAY NOT BE DISCLOSED WITHOUT WRITTEN CONSENT FROM SOURIAU USA, INC.

DWG. NO.

SA94843

# PERFORMANCE CHARACTERISTICS

**MECHANICAL:**

- MAGNETIC PERMEABILITY:** ALL MATERIALS DO NOT EXHIBIT A RELATIVE MAGNETIC PERMEABILITY OF GREATER THAN 2 IN ACCORDANCE WITH MIL-T-81714, PARA. 4.6.15. REF: MIL-STD-1344, METHOD 3006.
- MAINTENANCE AGING:** IN ACCORDANCE WITH MIL-T-81714, PARA. 4.6.3.
- CONTACT INSERTION/REMOVAL FORCE:** 10 LBS [44,4N] MAX. IN ACCORDANCE WITH MIL-T-81714, PARA.4.6.3
- CONTACT RETENTION:** 20 LBS [88,9N] MIN. IN ACCORDANCE WITH MIL-T-81714, PARA. 4.6.4. AXIAL DISPLACEMENT DOES NOT EXCEED .012 [0,30]. REF: MIL-STD-1344, METHOD 2007.
- PROBE DAMAGE:** IN ACCORDANCE WITH MIL-T-81714, PARA. 4.6.2.
- RETENTION SYSTEM FLUID IMMERSION:** IN ACCORDANCE WITH MIL-T-81714, PARA. 4.6.23.
- INTERNAL CONTACT DURABILITY:** 100 CYCLES OF MATING AND UNMATING TO DEPTH OF MECHANICAL AND ELECTRICAL ENGAGEMENT IN ACCORDANCE WITH MIL-T-81714, PARA. 4.6.19.
- OVERSIZE PIN CONTACT PROTECTION:** GROUNDING MODULE DESIGNED TO PREVENT ENTRANCE OF AN OVERSIZE TEST PIN OF Ø.070 [1,78] IN ACCORDANCE WITH MIL-T-81714, PARA. 4.6.20.
- CONTACT WALKOUT:** IN ACCORDANCE WITH MIL-T-81714, PARA. 4.6.22. REF: MIL-STD-1549.

SEE DRAWING SE94834 FOR  
FEEDBACK MODULE



FEEDBACK MODULE INSTALLED IN  
GROUNDING AND MOUNTING TRACKS  
SCALE 1:1

---	ALL REV. RECORDED ON SHT. 1	---	---
REV	DESCRIPTION	BY DATE	CHKD DATE

DRAWING TITLE			
<b>TRACKS, GROUNDING &amp; MOUNTING</b>			
CAT NO. <b>RBGT _ &amp; RBMT _ (SEE TABLE, SHT. 2)</b>			
CAGE NO.: 09922		SIZE: A	
<b>CUSTOMER</b>		<b>SOURIAU</b>	
INTERPRET THIS DRAWING IN ACCORDANCE WITH ASME Y14.5M - 1994.		<b>www.souriau.com</b>	
APPROVAL		DRAWING SCALE: 1:1	
DRAWN: VKP		11-15-10	
CHKD : SDH		11-15-10	
DSGN : JDA		10-13-92	
MFG : DH		11-15-10	
QC : DK		11-15-10	
DRAWING NO.		REV	
SA94843		U	
4 OF 6			

LINEAR MEASURE:		INCH [mm]
THIRD ANGLE PROJECTION		
TOLERANCES UNLESS OTHERWISE SPECIFIED		
No. OF PLACES	INCH [mm]	
ONE PLACE	±.1 [±3]	
TWO PLACES	±.02 [±0.5]	
THREE PLACES	±.010 [±0.25]	
ANGLES ±1°		

THIS DRAWING IS A CONTROLLED DOCUMENT FOR SOURIAU USA, INC. IT IS SUBJECT TO CHANGE WITHOUT NOTIFICATION. CONTACT THE DOCUMENT CONTROL CENTER FOR THE LATEST REVISION.

**PRO-E**

THE INFORMATION CONTAINED IN THIS DRAWING IS CONFIDENTIAL AND MAY NOT BE DISCLOSED WITHOUT WRITTEN CONSENT FROM SOURIAU USA, INC.

DWG. NO.

SA94843

THIS DRAWING IS A CONTROLLED DOCUMENT FOR SOURIAU USA, INC. IT IS SUBJECT TO CHANGE WITHOUT NOTIFICATION. CONTACT THE DOCUMENT CONTROL CENTER FOR THE LATEST REVISION.

PRO-E

THE INFORMATION CONTAINED IN THIS DRAWING IS CONFIDENTIAL AND MAY NOT BE DISCLOSED WITHOUT WRITTEN CONSENT FROM SOURIAU USA, INC.



GROUNDING TRACK - CATALOG NO. RBGT4 SHOWN

---	ALL REV. RECORDED ON SHT. 1	---	---
REV	DESCRIPTION	BY DATE	CHKD DATE

DRAWING TITLE  
**TRACKS, GROUNDING & MOUNTING**

CAT NO. **RBGT** & **RBMT** (SEE TABLE, SHT. 2)

CAGE NO.: 09922 SIZE: A

<p>LINEAR MEASURE: <b>INCH</b> [mm]</p> <p>THIRD ANGLE PROJECTION</p> <p>TOLERANCES UNLESS OTHERWISE SPECIFIED</p> <table border="1"> <tr> <th>No. OF PLACES</th> <th>INCH [mm]</th> </tr> <tr> <td>ONE PLACE</td> <td>±.1 [±3]</td> </tr> <tr> <td>TWO PLACES</td> <td>±.02 [±0.5]</td> </tr> <tr> <td>THREE PLACES</td> <td>±.010 [±0.25]</td> </tr> </table> <p>ANGLES ±1°</p>	No. OF PLACES	INCH [mm]	ONE PLACE	±.1 [±3]	TWO PLACES	±.02 [±0.5]	THREE PLACES	±.010 [±0.25]	<p><b>CUSTOMER</b></p> <p>INTERPRET THIS DRAWING IN ACCORDANCE WITH ASME Y14.5M - 1994.</p>	<p><b>SOURIAU</b></p> <p>www.souriau.com</p>	<p>APPROVAL</p> <table border="1"> <tr> <td>DRAWN:</td> <td>VKP</td> <td>11-15-10</td> </tr> <tr> <td>CHKD :</td> <td>SDH</td> <td>11-15-10</td> </tr> <tr> <td>DSGN :</td> <td>JDA</td> <td>10-13-92</td> </tr> <tr> <td>MFG :</td> <td>DH</td> <td>11-15-10</td> </tr> <tr> <td>QC :</td> <td>DK</td> <td>11-15-10</td> </tr> </table>	DRAWN:	VKP	11-15-10	CHKD :	SDH	11-15-10	DSGN :	JDA	10-13-92	MFG :	DH	11-15-10	QC :	DK	11-15-10
	No. OF PLACES	INCH [mm]																								
	ONE PLACE	±.1 [±3]																								
	TWO PLACES	±.02 [±0.5]																								
THREE PLACES	±.010 [±0.25]																									
DRAWN:	VKP	11-15-10																								
CHKD :	SDH	11-15-10																								
DSGN :	JDA	10-13-92																								
MFG :	DH	11-15-10																								
QC :	DK	11-15-10																								
DRAWING SCALE: 1:1																										
DRAWING NO.	REV																									
SA94843	U																									

THIS DRAWING IS A CONTROLLED DOCUMENT FOR SOURIAU USA, INC. IT IS SUBJECT TO CHANGE WITHOUT NOTIFICATION. CONTACT THE DOCUMENT CONTROL CENTER FOR THE LATEST REVISION.

PRO-E

THIS DRAWING IS CONFIDENTIAL AND MAY NOT BE DISCLOSED WITHOUT WRITTEN CONSENT FROM SOURIAU USA, INC.

DWG. NO.

SA94843



MOUNTING TRACK - CATALOG NO. RBMT4 SHOWN

DIMENSIONS, INK STAMPING, AND OTHER FEATURES ARE THE SAME AS THE GROUNDING TRACK EXCEPT AS SHOWN.

SOURIAU CATALOG NO.	BOEING PART NO.	MOUNTING TRACK			FEEDBACK MODULES ACCOMMODATED SEE DWG. SE94834
		SOURIAU CATALOG NO.	BOEING PART NO.	±.010 [0.25]	
RBGT2	S280W 555-502	RBMT2	S280W 555-602	2.000 [50.80]	2
RBGT4	S280W 555-504	RBMT4	S280W 555-604	4.000 [101.60]	4
RBGT6	S280W 555-506	RBMT6	S280W 555-606	6.000 [152.40]	6
RBGT8	S280W 555-508	RBMT8	S280W 555-608	8.000 [203.20]	8
RBGT10	S280W 555-510	RBMT10	S280W 555-610	10.000 [254.00]	10
RBGT14	S280W 555-514	RBMT14	S280W 555-614	14.000 [355.60]	14
RBGT16	S280W 555-516	RBMT16	S280W 555-616	16.000 [406.40]	16
RBGT18	S280W 555-518	RBMT18	S280W 555-618	18.000 [457.20]	18
RBGT20	S280W 555-520	RBMT20	S280W 555-620	20.000 [508]	20
RBGT22	S280W 555-522	RBMT22	S280W 555-622	22.000 [558.80]	22
RBGT26	S280W 555-526	RBMT26	S280W 555-626	26.000 [660.40]	26
RBGT28	S280W 555-528	RBMT28	S280W 555-628	28.000 [711.20]	28
RBGT34	S280W 555-534	RBMT34	S280W 555-634	34.000 [863.60]	34
RBGT38	S280W 555-538	RBMT38	S280W 555-638	38.000 [965.20]	38

---	ALL REV. RECORDED ON SHT. 1	---	---
REV	ECN NUMBER	BY DATE	CHKD DATE

DRAWING TITLE  
**TRACKS, GROUNDING & MOUNTING**

CAT NO. **RBGT \_ & RBMT \_ (SEE TABLE, SHT. 2)**

CAGE NO.: 09922 SIZE: A

<p><b>CUSTOMER</b></p> <p>INTERPRET THIS DRAWING IN ACCORDANCE WITH ASME Y14.5M - 1994.</p>	<p><b>SOURIAU</b></p> <p>www.souriau.com</p>	<p>APPROVAL</p> <p>DRAWN: VKP 11-15-10</p> <p>CHKD : SDH 11-15-10</p> <p>DSGN : JDA 10-13-92</p> <p>MFG : DH 11-15-10</p> <p>QC : DK 11-15-10</p>
		<p>DRAWING SCALE: 1:1</p>
		<p>DRAWING NO. REV</p> <p>SA94843 U</p>
		<p>6 OF 6</p>
		<p>6 OF 6</p>

LINEAR MEASURE:	<b>INCH</b> [mm]
THIRD ANGLE PROJECTION	
TOLERANCES UNLESS OTHERWISE SPECIFIED	
No. OF PLACES	INCH [mm]
ONE PLACE	±.1 [±3]
TWO PLACES	±.02 [±0.5]
THREE PLACES	±.010 [±0.25]
ANGLES ±1°	



Компания «ЭлектроПласт» предлагает заключение долгосрочных отношений при поставках импортных электронных компонентов на взаимовыгодных условиях!

Наши преимущества:

- Оперативные поставки широкого спектра электронных компонентов отечественного и импортного производства напрямую от производителей и с крупнейших мировых складов;
- Поставка более 17-ти миллионов наименований электронных компонентов;
- Поставка сложных, дефицитных, либо снятых с производства позиций;
- Оперативные сроки поставки под заказ (от 5 рабочих дней);
- Экспресс доставка в любую точку России;
- Техническая поддержка проекта, помощь в подборе аналогов, поставка прототипов;
- Система менеджмента качества сертифицирована по Международному стандарту ISO 9001;
- Лицензия ФСБ на осуществление работ с использованием сведений, составляющих государственную тайну;
- Поставка специализированных компонентов (Xilinx, Altera, Analog Devices, Intersil, Interpoint, Microsemi, Aeroflex, Peregrine, Syfer, Eurofarad, Texas Instrument, Miteq, Cobham, E2V, MA-COM, Hittite, Mini-Circuits, General Dynamics и др.);

Помимо этого, одним из направлений компании «ЭлектроПласт» является направление «Источники питания». Мы предлагаем Вам помощь Конструкторского отдела:

- Подбор оптимального решения, техническое обоснование при выборе компонента;
- Подбор аналогов;
- Консультации по применению компонента;
- Поставка образцов и прототипов;
- Техническая поддержка проекта;
- Защита от снятия компонента с производства.



#### Как с нами связаться

**Телефон:** 8 (812) 309 58 32 (многоканальный)

**Факс:** 8 (812) 320-02-42

**Электронная почта:** [org@eplast1.ru](mailto:org@eplast1.ru)

**Адрес:** 198099, г. Санкт-Петербург, ул. Калинина, дом 2, корпус 4, литера А.