

MMBD2835LT1G, MMBD2836LT1G, SMMBD2835LT1G

Monolithic Dual Switching Diodes

Features

- AEC-Q101 Qualified and PPAP Capable
- S Prefix for Automotive and Other Applications Requiring Unique Site and Control Change Requirements
- These Devices are Pb-Free, Halogen Free/BFR Free and are RoHS Compliant*

MAXIMUM RATINGS (EACH DIODE)

Rating	Symbol	Value	Unit
Reverse Voltage MMBD2835LT1G, SMMBD2835LT1G MMBD2836LT1G	V_R	35 75	Vdc
Forward Current	I_F	100	mAdc

THERMAL CHARACTERISTICS

Total Device Dissipation FR-5 Board (Note 1) $T_A = 25^\circ\text{C}$ Derate above 25°C	P_D	225	mW
		1.8	mW/ $^\circ\text{C}$
Thermal Resistance, Junction-to-Ambient	$R_{\theta JA}$	556	$^\circ\text{C}/\text{W}$
Total Device Dissipation Alumina Substrate, (Note 2) $T_A = 25^\circ\text{C}$ Derate above 25°C	P_D	300	mW
		2.4	mW/ $^\circ\text{C}$
Thermal Resistance, Junction-to-Ambient	$R_{\theta JA}$	417	$^\circ\text{C}/\text{W}$
Junction and Storage Temperature	T_J, T_{stg}	-55 to +150	$^\circ\text{C}$

Stresses exceeding Maximum Ratings may damage the device. Maximum Ratings are stress ratings only. Functional operation above the Recommended Operating Conditions is not implied. Extended exposure to stresses above the Recommended Operating Conditions may affect device reliability.

1. FR-5 = $1.0 \times 0.75 \times 0.062$ in.
2. Alumina = $0.4 \times 0.3 \times 0.024$ in. 99.5% alumina.

*For additional information on our Pb-Free strategy and soldering details, please download the ON Semiconductor Soldering and Mounting Techniques Reference Manual, SOLDERRM/D.



ON Semiconductor®

<http://onsemi.com>

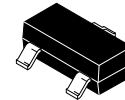

SOT-23 (TO-236AB)
CASE 318-08
STYLE 12

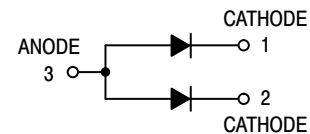

MARKING DIAGRAM

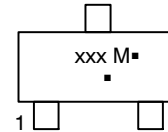

xxx = Specific Device Code
A3X = MMBD2835LT1G
SMMBD2835LT1G
A2X = MMBD2836LT1G
M = Date Code
▪ = Pb-Free Package
(Note: Microdot may be in either location)

*Date Code orientation and/or overbar may vary depending upon manufacturing location.

ORDERING INFORMATION

Device	Package	Shipping†
MMBD2835LT1G	SOT-23 (Pb-Free)	3,000 / Tape & Reel
SMMBD2835LT1G	SOT-23 (Pb-Free)	3,000 / Tape & Reel
MMBD2836LT1G	SOT-23 (Pb-Free)	3,000 / Tape & Reel

†For information on tape and reel specifications, including part orientation and tape sizes, please refer to our Tape and Reel Packaging Specifications Brochure, BRD8011/D.

MMBD2835LT1G, MMBD2836LT1G, SMMBD2835LT1G

ELECTRICAL CHARACTERISTICS ($T_A = 25^\circ\text{C}$ unless otherwise noted) (EACH DIODE)

Characteristic	Symbol	Min	Max	Unit
OFF CHARACTERISTICS				
Reverse Breakdown Voltage ($I_R = 100 \mu\text{Adc}$) MMBD2835LT1G, SMMBD2835LT1G MMBD2836LT1G	$V_{(BR)}$	35 75	- -	Vdc
Reverse Voltage Leakage Current (Note 3) ($V_R = 30 \text{ Vdc}$) MMBD2835LT1G, SMMBD2835LT1G ($V_R = 50 \text{ Vdc}$) MMBD2836LT1G	I_R	- -	100 100	nAdc
Diode Capacitance ($V_R = 0 \text{ V}$, $f = 1.0 \text{ MHz}$)	C_T	-	4.0	pF
Forward Voltage ($I_F = 10 \text{ mAdc}$) ($I_F = 50 \text{ mAdc}$) ($I_F = 100 \text{ mAdc}$)	V_F	- - -	1.0 1.0 1.2	Vdc
Reverse Recovery Time ($I_F = I_R = 10 \text{ mAdc}$, $I_{R(REC)} = 1.0 \text{ mAdc}$) (Figure 1)	t_{rr}	-	4.0	ns

3. For each individual diode while the second diode is unbiased.

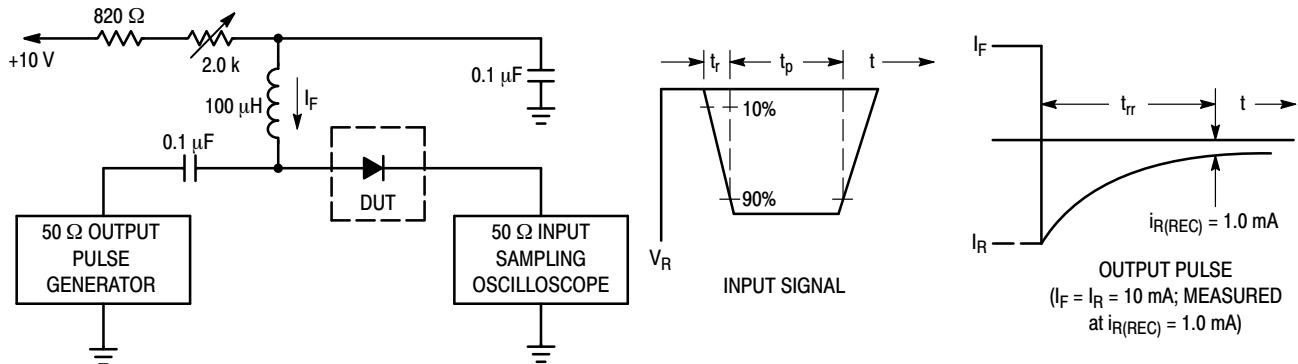

- Notes: 1. A 2.0 kΩ variable resistor adjusted for a Forward Current (I_F) of 10 mA.
 2. Input pulse is adjusted so $I_{R(\text{peak})}$ is equal to 10 mA.
 3. $t_p \gg t_{rr}$

Figure 1. Recovery Time Equivalent Test Circuit

MMBD2835LT1G, MMBD2836LT1G, SMMBD2835LT1G

CURVES APPLICABLE TO EACH CATHODE

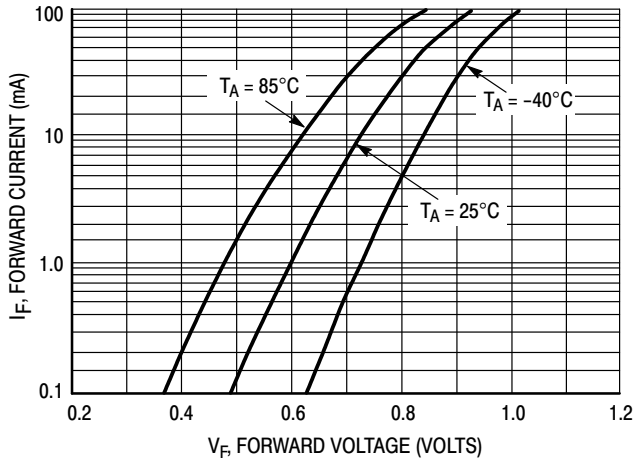

Figure 2. Forward Voltage

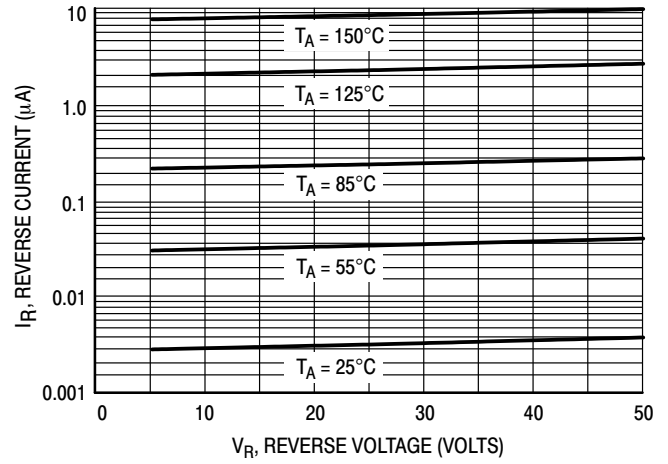

Figure 3. Leakage Current

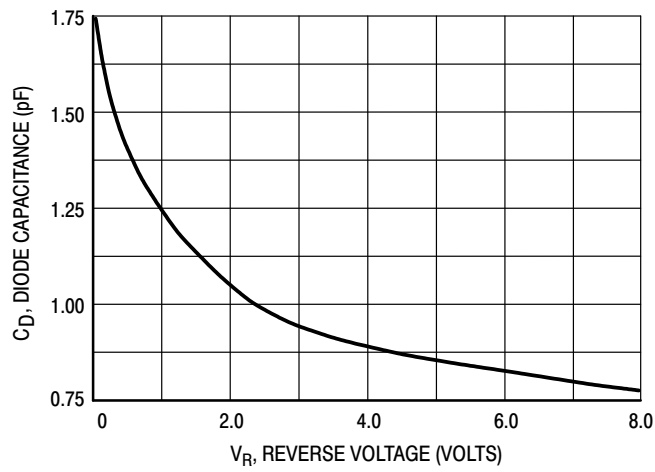
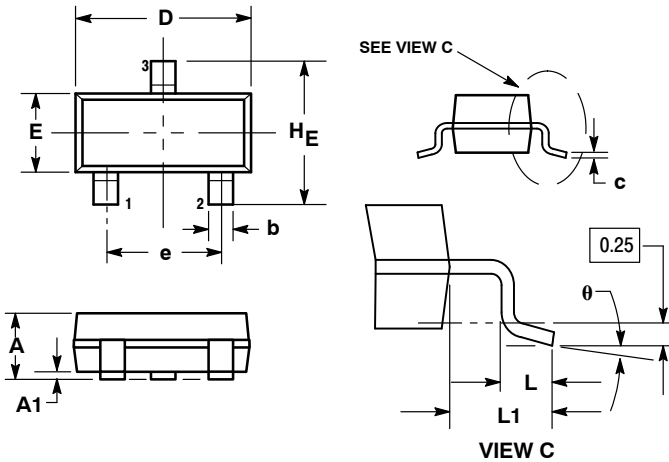

Figure 4. Capacitance

MMBD2835LT1G, MMBD2836LT1G, SMMBD2835LT1G

PACKAGE DIMENSIONS

SOT-23 (TO-236)
CASE 318-08
ISSUE AP



NOTES:

1. DIMENSIONING AND TOLERANCING PER ANSI Y14.5M, 1982.
2. CONTROLLING DIMENSION: INCH.
3. MAXIMUM LEAD THICKNESS INCLUDES LEAD FINISH THICKNESS. MINIMUM LEAD THICKNESS IS THE MINIMUM THICKNESS OF BASE MATERIAL.
4. DIMENSIONS D AND E DO NOT INCLUDE MOLD FLASH, PROTRUSIONS, OR GATE BURRS.

DIM	MILLIMETERS			INCHES		
	MIN	NOM	MAX	MIN	NOM	MAX
A	0.89	1.00	1.11	0.035	0.040	0.044
A1	0.01	0.06	0.10	0.001	0.002	0.004
b	0.37	0.44	0.50	0.015	0.018	0.020
c	0.09	0.13	0.18	0.003	0.005	0.007
D	2.80	2.90	3.04	0.110	0.114	0.120
E	1.20	1.30	1.40	0.047	0.051	0.055
e	1.78	1.90	2.04	0.070	0.075	0.081
L	0.10	0.20	0.30	0.004	0.008	0.012
L1	0.35	0.54	0.69	0.014	0.021	0.029
HE	2.10	2.40	2.64	0.083	0.094	0.104
θ	0°	---	10°	0°	---	10°

STYLE 12:

1. CATHODE
2. CATHODE
3. ANODE

SOLDERING FOOTPRINT

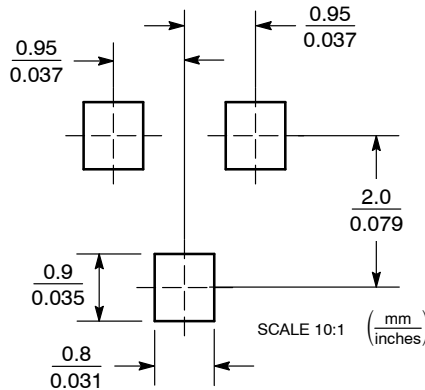

ON Semiconductor and are registered trademarks of Semiconductor Components Industries, LLC (SCILLC). SCILLC reserves the right to make changes without further notice to any products herein. SCILLC makes no warranty, representation or guarantee regarding the suitability of its products for any particular purpose, nor does SCILLC assume any liability arising out of the application or use of any product or circuit, and specifically disclaims any and all liability, including without limitation special, consequential or incidental damages. "Typical" parameters which may be provided in SCILLC data sheets and/or specifications can and do vary in different applications and actual performance may vary over time. All operating parameters, including "Typicals" must be validated for each customer application by customer's technical experts. SCILLC does not convey any license under its patent rights nor the rights of others. SCILLC products are not designed, intended, or authorized for use as components in systems intended for surgical implant into the body, or other applications intended to support or sustain life, or for any other application in which the failure of the SCILLC product could create a situation where personal injury or death may occur. Should Buyer purchase or use SCILLC products for any such unintended or unauthorized application, Buyer shall indemnify and hold SCILLC and its officers, employees, subsidiaries, affiliates, and distributors harmless against all claims, costs, damages, and expenses, and reasonable attorney fees arising out of, directly or indirectly, any claim of personal injury or death associated with such unintended or unauthorized use, even if such claim alleges that SCILLC was negligent regarding the design or manufacture of the part. SCILLC is an Equal Opportunity/Affirmative Action Employer. This literature is subject to all applicable copyright laws and is not for resale in any manner.

PUBLICATION ORDERING INFORMATION

LITERATURE FULFILLMENT:

Literature Distribution Center for ON Semiconductor
P.O. Box 5163, Denver, Colorado 80217 USA
Phone: 303-675-2175 or 800-344-3860 Toll Free USA/Canada
Fax: 303-675-2176 or 800-344-3867 Toll Free USA/Canada
Email: orderlit@onsemi.com

N. American Technical Support: 800-282-9855 Toll Free
USA/Canada
Europe, Middle East and Africa Technical Support:
Phone: 421 33 790 2910
Japan Customer Focus Center
Phone: 81-3-5817-1050

ON Semiconductor Website: www.onsemi.com

Order Literature: <http://www.onsemi.com/orderlit>

For additional information, please contact your local Sales Representative



Компания «ЭлектроПласт» предлагает заключение долгосрочных отношений при поставках импортных электронных компонентов на взаимовыгодных условиях!

Наши преимущества:

- Оперативные поставки широкого спектра электронных компонентов отечественного и импортного производства напрямую от производителей и с крупнейших мировых складов;
- Поставка более 17-ти миллионов наименований электронных компонентов;
- Поставка сложных, дефицитных, либо снятых с производства позиций;
- Оперативные сроки поставки под заказ (от 5 рабочих дней);
- Экспресс доставка в любую точку России;
- Техническая поддержка проекта, помощь в подборе аналогов, поставка прототипов;
- Система менеджмента качества сертифицирована по Международному стандарту ISO 9001;
- Лицензия ФСБ на осуществление работ с использованием сведений, составляющих государственную тайну;
- Поставка специализированных компонентов (Xilinx, Altera, Analog Devices, Intersil, Interpoint, Microsemi, Aeroflex, Peregrine, Syfer, Eurofarad, Texas Instrument, Miteq, Cobham, E2V, MA-COM, Hittite, Mini-Circuits, General Dynamics и др.);

Помимо этого, одним из направлений компании «ЭлектроПласт» является направление «Источники питания». Мы предлагаем Вам помощь Конструкторского отдела:

- Подбор оптимального решения, техническое обоснование при выборе компонента;
- Подбор аналогов;
- Консультации по применению компонента;
- Поставка образцов и прототипов;
- Техническая поддержка проекта;
- Защита от снятия компонента с производства.



Как с нами связаться

Телефон: 8 (812) 309 58 32 (многоканальный)

Факс: 8 (812) 320-02-42

Электронная почта: org@eplast1.ru

Адрес: 198099, г. Санкт-Петербург, ул. Калинина, дом 2, корпус 4, литера А.