



200kHz, 4 μ A, Rail-to-Rail I/O Op Amps with Shutdown

MAX9910-MAX9913

General Description

The single MAX9910/MAX9911 and dual MAX9912/MAX9913 operational amplifiers (op amps) feature a maximized ratio of gain bandwidth (GBW) to supply current and are ideal for battery-powered applications such as portable instrumentation, portable medical equipment, and wireless handsets. These CMOS op amps feature an ultra-low input-bias current of 1pA, rail-to-rail inputs and outputs, low supply current of 4 μ A, and operate from a single 1.8V to 5.5V supply. For additional power conservation, the MAX9911/MAX9913 feature a low-power shutdown mode that reduces supply current to 1nA, and puts the amplifiers' outputs in a high-impedance state. These devices are unity-gain stable with a 200kHz GBW product.

The MAX9910 is available in a 5-pin SC70 package. The MAX9911 is available in tiny 6-bump WLP and a 6-pin SC70 packages. The MAX9912 is available in an 8-pin SOT23 package, and the MAX9913 is available in a 10-pin μ MAX[®] package. All devices are specified over the -40°C to +85°C extended operating temperature range.

Applications

Portable Medical Devices
 Portable Test Equipment
 Laptops
 Data-Acquisition Equipment

Typical Operating Circuit

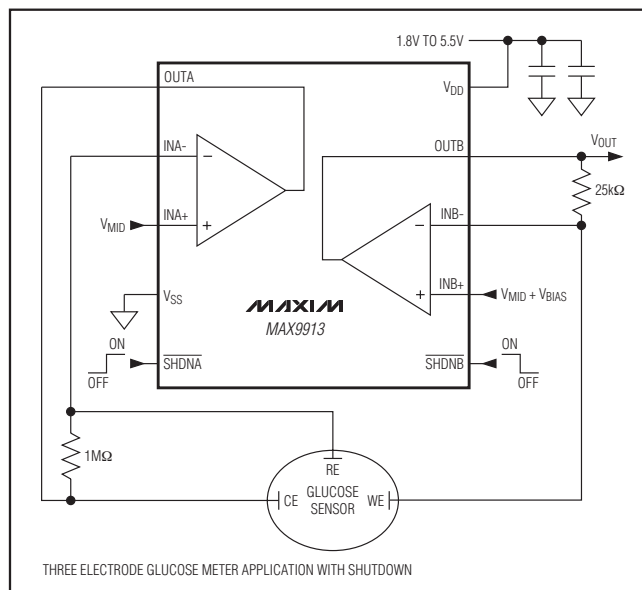

μ MAX is a registered trademark of Maxim Integrated Products, Inc.



Maxim Integrated Products 1

For pricing, delivery, and ordering information, please contact Maxim Direct at 1-888-629-4642, or visit Maxim's website at www.maxim-ic.com.

Features

- ◆ 200kHz GBW
- ◆ Ultra-Low 4 μ A Supply Current
- ◆ Single 1.8V to 5.5V Supply Voltage Range
- ◆ Ultra-Low 1pA Input Bias Current
- ◆ Rail-to-Rail Input and Output Voltage Ranges
- ◆ Low \pm 200 μ V Input Offset Voltage
- ◆ Low 0.001 μ A Shutdown Current
- ◆ High-Impedance Output During Shutdown (MAX9911/MAX9913)
- ◆ Unity-Gain Stable
- ◆ Available in Tiny WLP, SC70, SOT23, and μ MAX Packages

Ordering Information

PART	TEMP RANGE	PIN-PACKAGE	TOP MARK
MAX9910EXK+T	-40°C to +85°C	5 SC70	AGA
MAX9910EXK-T	-40°C to +85°C	5 SC70	AGA
MAX9911EXT+T	-40°C to +85°C	6 SC70	ACA
MAX9911EXT-T	-40°C to +85°C	6 SC70	ACA
MAX9911EWT+	-40°C to +85°C	6 WLP	BQ
MAX9912EKA+T	-40°C to +85°C	8 SOT23	AEJY
MAX9912EKA-T	-40°C to +85°C	8 SOT23	AEJY
MAX9913EUB	-40°C to +85°C	10 μ MAX	—
MAX9913EUB+	-40°C to +85°C	10 μ MAX	—

+ Denotes lead (Pb)-free/RoHS-compliant package.

Selector Guide

PART	AMPLIFIERS PER PACKAGE	SHUTDOWN MODE
MAX9910EXK-T	1	No
MAX9911EXT-T	1	Yes
MAX9912EKA-T	2	No
MAX9913EUB	2	Yes

200kHz, 4 μ A, Rail-to-Rail I/O Op Amps with Shutdown

ABSOLUTE MAXIMUM RATINGS

Power-Supply Voltage (V_{DD} to V_{SS})-0.3V to +6.0V
 IN_+ , IN_- , OUT_- , \overline{SHDN}_- ($V_{SS} - 0.3V$) to ($V_{DD} + 0.3V$)
 Current into IN_+ , IN_- $\pm 20mA$
 Output Short-Circuit Duration to V_{DD} or V_{SS} Continuous
 Continuous Power Dissipation ($T_A = +70^\circ C$)
 5-Pin SC70 (derate 3.1mW/ $^\circ C$ above +70 $^\circ C$) 247mW
 6-Bump WLP (derate 10.5mW/ $^\circ C$ above +70 $^\circ C$) 840mW
 6-Pin SC70 (derate 3.1mW/ $^\circ C$ above +70 $^\circ C$) 245mW

8-Pin SOT23 (derate 9.1mW/ $^\circ C$ above +70 $^\circ C$) 727mW
 10-Pin μ MAX (derate 5.6mW/ $^\circ C$ above +70 $^\circ C$) 444mW
 Operating Temperature Range -40 $^\circ C$ to +85 $^\circ C$
 Junction Temperature +150 $^\circ C$
 Storage Temperature Range -65 $^\circ C$ to +150 $^\circ C$
 Lead Temperature (excluding WLP, soldering 10s) +300 $^\circ C$
 Soldering Temperature (reflow)
 Lead(Pb)-Free Packages +260 $^\circ C$
 Packages Containing Lead(Pb) +240 $^\circ C$

Stresses beyond those listed under "Absolute Maximum Ratings" may cause permanent damage to the device. These are stress ratings only, and functional operation of the device at these or any other conditions beyond those indicated in the operational sections of the specifications is not implied. Exposure to absolute maximum rating conditions for extended periods may affect device reliability.

ELECTRICAL CHARACTERISTICS

($V_{DD} = 1.8V$ to $5.5V$, $V_{SS} = 0V$, $V_{CM} = 0V$, $V_{OUT} = V_{DD} / 2$, $R_L = \infty$ connected to $V_{DD} / 2$, $\overline{SHDN}_- = V_{DD}$, $T_A = +25^\circ C$, unless otherwise noted.) (Note 1)

PARAMETER	SYMBOL	CONDITIONS	MIN	TYP	MAX	UNITS
Supply Voltage Range	V_{DD}	Guaranteed by PSRR test	1.8		5.5	V
Supply Current	I_{DD}	MAX9910/MAX9911	$V_{DD} = 1.8V$	4		μA
			$V_{DD} = 5.5V$	4	5.0	
		MAX9912/MAX9913	$V_{DD} = 1.8V$	7		
			$V_{DD} = 5.5V$	7	9	
Shutdown Supply Current	$I_{DD}(\overline{SHDN}_-)$	$\overline{SHDN}_- = GND$, MAX9911/MAX9913	0.001		0.5	μA
Input Offset Voltage	V_{OS}		± 0.2		± 1	mV
Input-Offset-Voltage Matching		MAX9912/MAX9913		± 250		μV
Input Bias Current	I_B	(Note 2)		± 1	± 10	pA
Input Offset Current	I_{OS}	(Note 2)		± 1	± 10	pA
Input Resistance	R_{IN}	Common mode		1		G Ω
		Differential mode, $-1mV < V_{IN} < +1mV$		10		
Input Common-Mode Range	V_{CM}	Guaranteed by CMRR test	$V_{SS} - 0.1$		$V_{DD} + 0.1$	V
Common-Mode Rejection Ratio	CMRR	$-0.1V < V_{CM} < V_{DD} + 0.1V$, $V_{DD} = 5.5V$	70	80		dB
Power-Supply Rejection Ratio	PSRR	$1.8V < V_{DD} < 5.5V$	65	95		dB
Open-Loop Gain	A_{VOL}	$25mV < V_{OUT} < V_{DD} - 25mV$, $R_L = 100k\Omega$, $V_{DD} = 5.5V$	95	120		dB
		$100mV < V_{OUT} < V_{DD} - 100mV$, $R_L = 5k\Omega$, $V_{DD} = 5.5V$	95	110		
Output-Voltage-Swing High	V_{OH}	$V_{DD} - V_{OUT}$	$R_L = 100k\Omega$	2.5	5	mV
			$R_L = 5k\Omega$	50	70	
			$R_L = 1k\Omega$	250		
Output-Voltage-Swing Low	V_{OL}	$V_{OUT} - V_{SS}$	$R_L = 100k\Omega$	2.5	5	mV
			$R_L = 5k\Omega$	50	70	
			$R_L = 1k\Omega$	250		
Channel-to-Channel Isolation	CH_{ISO}	Specified at DC, MAX9912/MAX9913		100		dB
Output Short-Circuit Current	$I_{OUT(SC)}$			± 15		mA

200kHz, 4μA, Rail-to-Rail I/O Op Amps with Shutdown

MAX9910-MAX9913

ELECTRICAL CHARACTERISTICS (continued)

($V_{DD} = 1.8V$ to $5.5V$, $V_{SS} = 0V$, $V_{CM} = 0V$, $V_{OUT} = V_{DD} / 2$, $R_L = \infty$ connected to $V_{DD} / 2$, $\overline{SHDN}_- = V_{DD}$, $T_A = +25^\circ C$, unless otherwise noted.) (Note 1)

PARAMETER	SYMBOL	CONDITIONS	MIN	TYP	MAX	UNITS
\overline{SHDN}_- Logic Low	V_{IL}	$V_{DD} = 1.8V$ to $3.6V$, MAX9911/MAX9913			0.4	V
		$V_{DD} = 3.6V$ to $5.5V$, MAX9911/MAX9913			0.8	
\overline{SHDN}_- Logic High	V_{IH}	$V_{DD} = 1.8V$ to $3.6V$, MAX9911/MAX9913	1.4			V
		$V_{DD} = 3.6V$ to $5.5V$, MAX9911/MAX9913	2			
\overline{SHDN}_- Input Bias Current	I_{IL}	$\overline{SHDN}_- = V_{SS}$, MAX9911/MAX9913 (Note 2)			1	nA
	I_{IH}	$\overline{SHDN}_- = V_{DD}$, MAX9911/MAX9913			500	
Output Leakage in Shutdown	$I_{OUT}(\overline{SHDN}_-)$	$\overline{SHDN}_- = V_{SS}$, $V_{OUT} = 0V$ to V_{DD} , MAX9911/MAX9913		1	500	nA
Gain-Bandwidth Product				200		kHz
Slew Rate				0.1		V/μs
Capacitive-Load Stability (See the <i>Driving Capacitive Loads</i> Section)	C_{LOAD}	No sustained oscillations	$A_V = 1V/V$		30	pF
			$A_V = 10V/V$		250	
			$R_L = 5k\Omega$, $A_V = 1V/V$		200	
			$R_{ISO} = 1k\Omega$, $A_V = 1V/V$		100	
Input Voltage-Noise Density		$f = 1kHz$		400		nV/√Hz
Input Current-Noise Density		$f = 1kHz$		0.001		pA/√Hz
Settling Time		To 0.1%, $V_{OUT} = 2V$ step, $A_V = -1V/V$		18		μs
Delay Time to Shutdown	t_{SH}	$I_{DD} = 5\%$ of normal operation, $V_{DD} = 5.5V$, $V_{\overline{SHDN}_-} = 5.5V$ to 0 step		2		μs
Delay Time to Enable	t_{EN}	$V_{OUT} = 2.7V$, V_{OUT} settles to 0.1%, $V_{DD} = 5.5V$, $V_{\overline{SHDN}_-} = 0$ to 5.5V step		30		μs
Power-Up Time		$V_{DD} = 0$ to 5.5V step		5		μs

ELECTRICAL CHARACTERISTICS

($V_{DD} = 1.8V$ to $5.5V$, $V_{SS} = 0V$, $V_{CM} = 0V$, $V_{OUT} = V_{DD} / 2$, $R_L = \infty$ connected to $V_{DD} / 2$, $\overline{SHDN}_- = V_{DD}$, $T_A = -40^\circ C$ to $+85^\circ C$, unless otherwise noted.) (Note 1)

PARAMETER	SYMBOL	CONDITIONS	MIN	TYP	MAX	UNITS
Supply Voltage Range	V_{DD}	Guaranteed by PSRR test	1.8		5.5	V
Supply Current	I_{DD}	MAX9910/MAX9911	$V_{DD} = 5.5V$		5.5	μA
		MAX9912/MAX9913			11	
Shutdown Supply Current	$I_{DD}(\overline{SHDN}_-)$	$\overline{SHDN}_- = GND$, MAX9911/MAX9913			1	μA
Input Offset Voltage	V_{OS}				±5	mV
Input-Offset-Voltage Temperature Coefficient	TC_{VOS}			±5		μV/°C

200kHz, 4 μ A, Rail-to-Rail I/O Op Amps with Shutdown

ELECTRICAL CHARACTERISTICS (continued)

($V_{DD} = 1.8V$ to $5.5V$, $V_{SS} = 0V$, $V_{CM} = 0V$, $V_{OUT} = V_{DD} / 2$, $R_L = \infty$ connected to $V_{DD} / 2$, $\overline{SHDN}_- = V_{DD}$, $T_A = -40^\circ C$ to $+85^\circ C$, unless otherwise noted.) (Note 1)

PARAMETER	SYMBOL	CONDITIONS	MIN	TYP	MAX	UNITS
Input Bias Current	I_B				± 30	pA
Input Offset Current	I_{OS}				± 20	pA
Input Common-Mode Range	V_{CM}	Guaranteed by CMRR test	$V_{SS} - 0.05$		$V_{DD} + 0.05$	V
Common-Mode Rejection Ratio	CMRR	$-0.05V < V_{CM} < V_{DD} + 0.05V$, $V_{DD} = 5.5V$	60			dB
Power-Supply Rejection Ratio	PSRR	$1.8V < V_{DD} < 5.5V$	59			dB
Open-Loop Gain	A_{VOL}	$25mV < V_{OUT} < V_{DD} - 25mV$, $R_L = 100k\Omega$, $V_{DD} = 5.5V$	85			dB
		$150mV < V_{OUT} < V_{DD} - 150mV$, $R_L = 5k\Omega$, $V_{DD} = 5.5V$	80			
Output-Voltage-Swing High	V_{OH}	$V_{DD} - V_{OUT}$	$R_L = 100k\Omega$		5	mV
			$R_L = 5k\Omega$		90	
Output-Voltage-Swing Low	V_{OL}	$V_{OUT} - V_{SS}$	$R_L = 100k\Omega$		5	mV
			$R_L = 5k\Omega$		90	
\overline{SHDN}_- Logic Low	V_{IL}	$V_{DD} = 1.8V$ to $3.6V$			0.4	V
		$V_{DD} = 3.6V$ to $5.5V$			0.8	
\overline{SHDN}_- Logic High	V_{IH}	$V_{DD} = 1.8V$ to $3.6V$, MAX9911/MAX9913	1.4			V
		$V_{DD} = 3.6V$ to $5.5V$, MAX9911/MAX9913	2			
\overline{SHDN}_- Input-Bias Current	I_{IL}	$\overline{SHDN}_- = V_{SS}$, MAX9911/MAX9913			5	nA
	I_{IH}	$\overline{SHDN}_- = V_{DD}$, MAX9911/MAX9913			1000	nA
Output Leakage in Shutdown	$I_{OUT(\overline{SHDN}_-)}$	$\overline{SHDN}_- = V_{SS}$, $V_{OUT} = 0V$ to V_{DD} , MAX9911/MAX9913			1000	nA

Note 1: Specifications are 100% tested at $T_A = +25^\circ C$ (exceptions noted). All temperature limits are guaranteed by design.

Note 2: Guaranteed by design, not production tested.

200kHz, 4 μ A, Rail-to-Rail I/O Op Amps with Shutdown

Typical Operating Characteristics

($V_{DD} = 3V$, $V_{SS} = V_{CM} = 0V$, R_L to $V_{DD} / 2$, $T_A = +25^\circ C$, unless otherwise noted.)

MAX9910-MAX9913

SUPPLY CURRENT vs. SUPPLY VOLTAGE

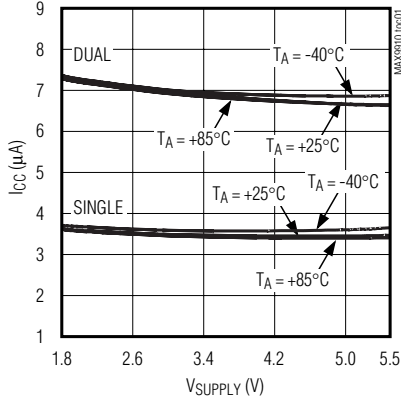

SHUTDOWN SUPPLY CURRENT vs. TEMPERATURE

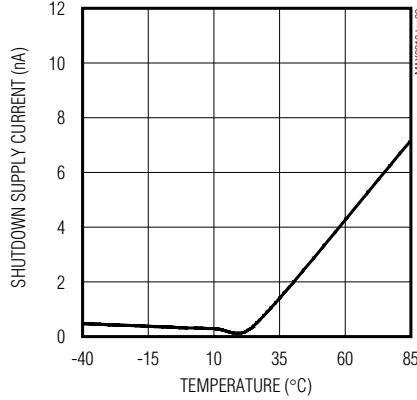

INPUT OFFSET VOLTAGE vs. INPUT COMMON-MODE VOLTAGE

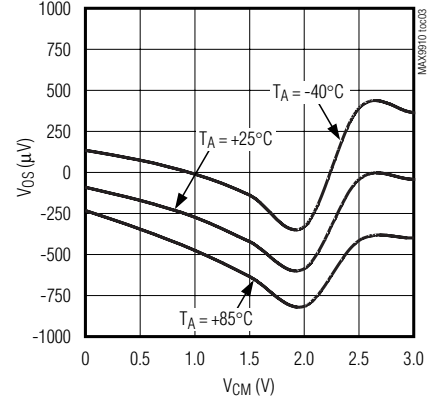

INPUT OFFSET VOLTAGE vs. TEMPERATURE

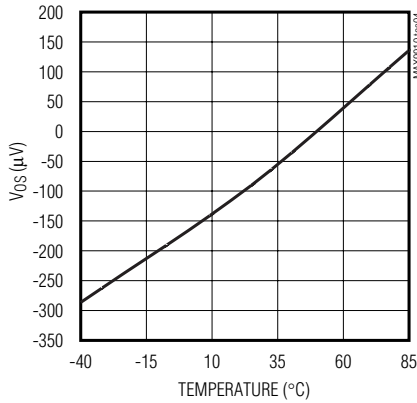

INPUT BIAS CURRENT vs. TEMPERATURE

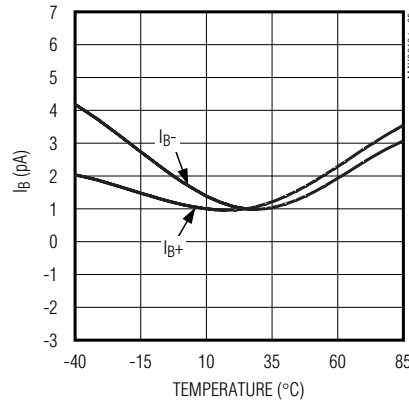

INPUT BIAS CURRENT vs. INPUT COMMON-MODE VOLTAGE

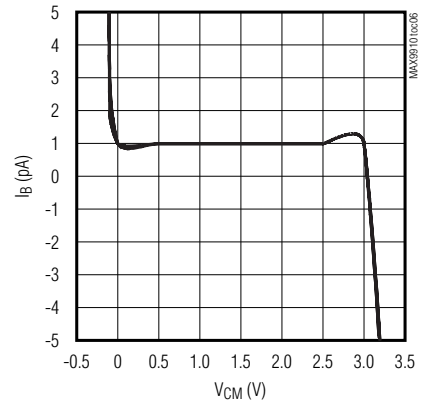

POWER-SUPPLY REJECTION RATIO vs. FREQUENCY

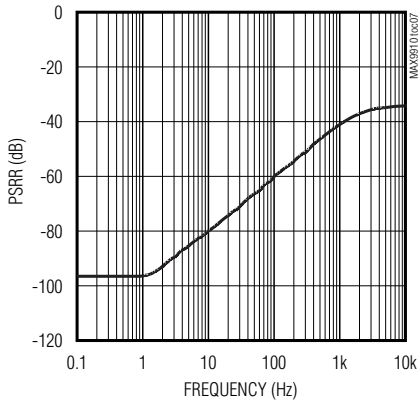

COMMON-MODE REJECTION RATIO vs. TEMPERATURE

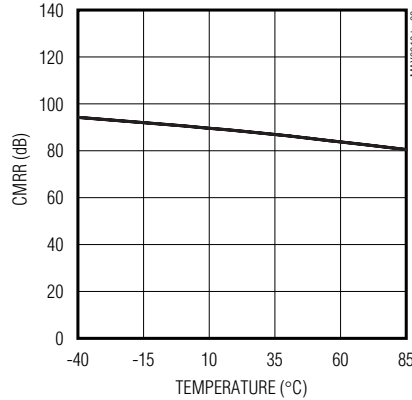

COMMON-MODE REJECTION RATIO vs. FREQUENCY

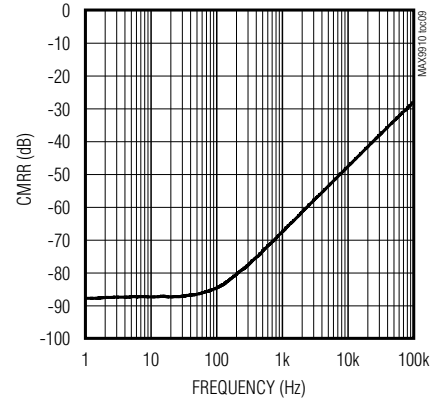

200kHz, 4μA, Rail-to-Rail I/O Op Amps with Shutdown

Typical Operating Characteristics (continued)

($V_{DD} = 3V$, $V_{SS} = V_{CM} = 0V$, R_L to $V_{DD} / 2$, $T_A = +25^\circ C$, unless otherwise noted.)

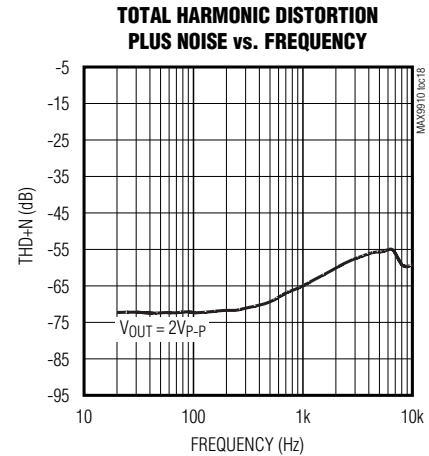
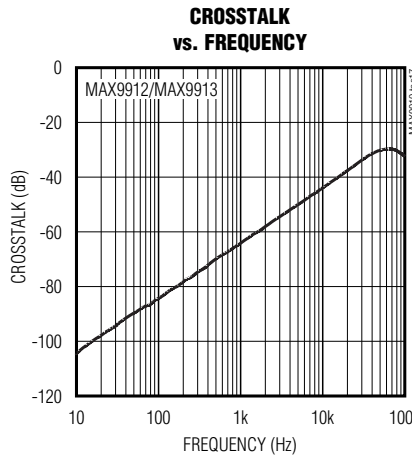
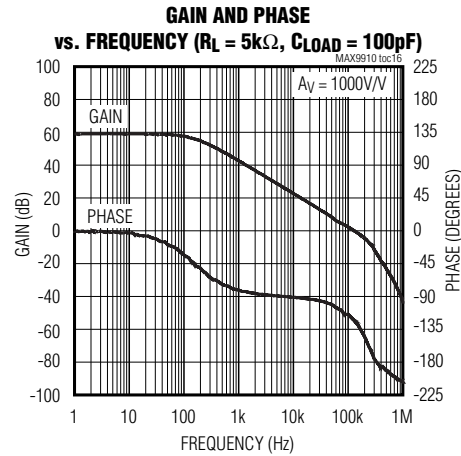
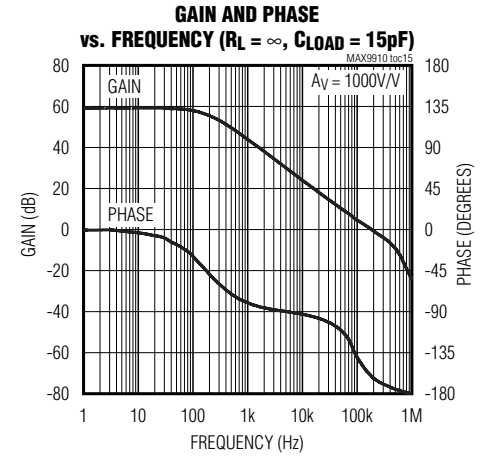
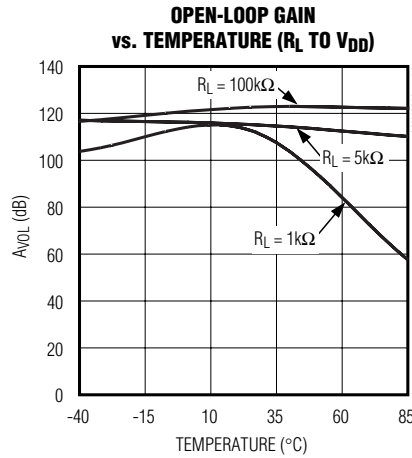
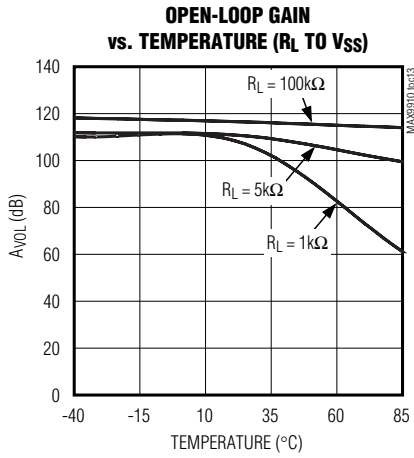
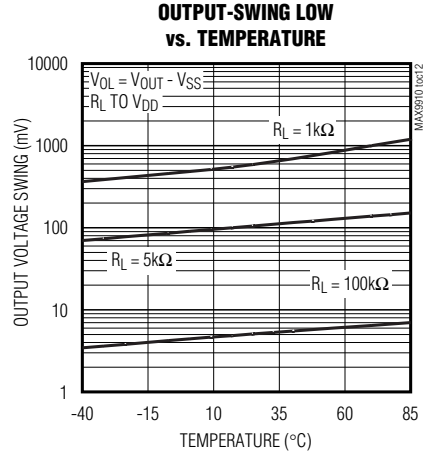
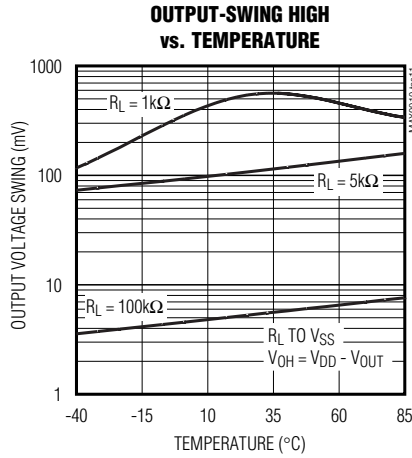
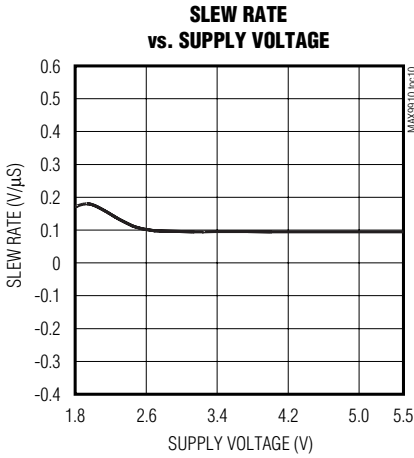

200kHz, 4μA, Rail-to-Rail I/O Op Amps with Shutdown

Typical Operating Characteristics (continued)

($V_{DD} = 3V$, $V_{SS} = V_{CM} = 0V$, R_L to $V_{DD} / 2$, $T_A = +25^\circ C$, unless otherwise noted.)

MAX9910-MAX9913

VOLTAGE-NOISE DENSITY vs. FREQUENCY

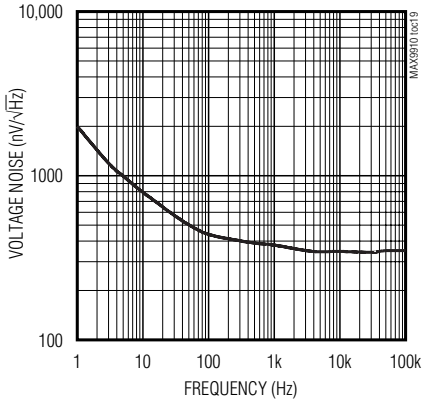

RESISTOR ISOLATION vs. CAPACITIVE LOAD

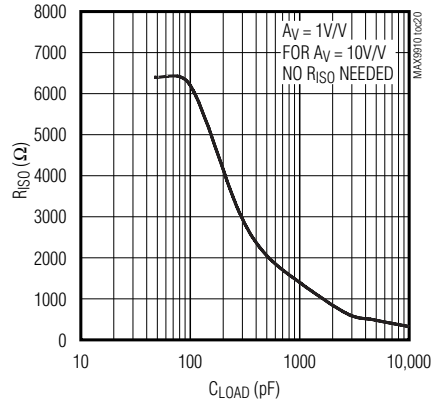

POWER-UP SETTLING TIME

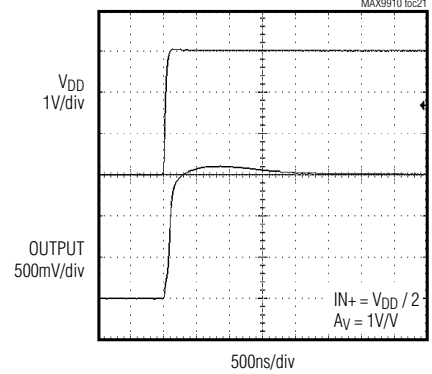

SHUTDOWN RESPONSE

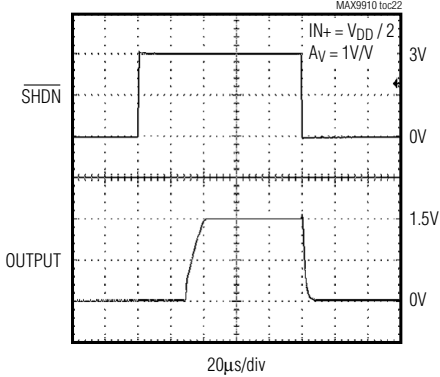

SMALL-SIGNAL PULSE RESPONSE (CLOAD = 15pF)

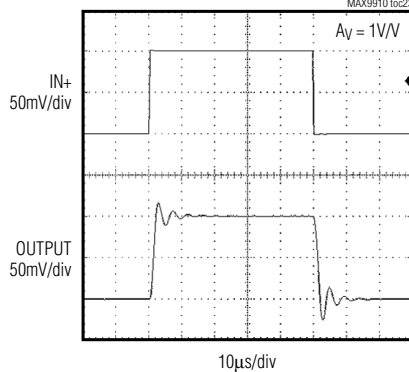

SMALL-SIGNAL PULSE RESPONSE (CLOAD = 100pF)

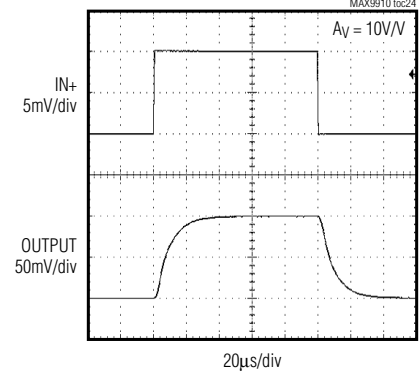

LARGE-SIGNAL PULSE RESPONSE (CLOAD = 15pF)

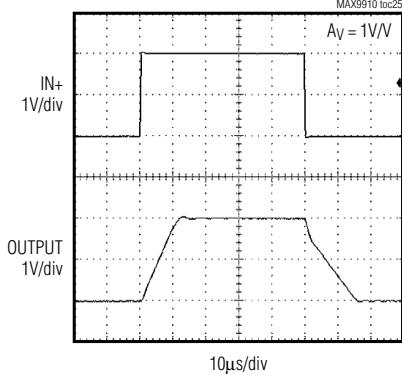

LARGE-SIGNAL PULSE RESPONSE (CLOAD = 100pF)

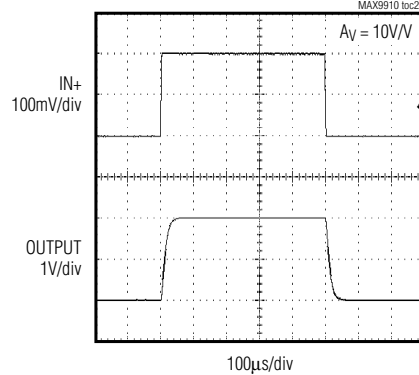

200kHz, 4μA, Rail-to-Rail I/O Op Amps with Shutdown

Typical Operating Characteristics (continued)

($V_{DD} = 3V$, $V_{SS} = V_{CM} = 0V$, R_L to $V_{DD} / 2$, $T_A = +25^\circ C$, unless otherwise noted.)

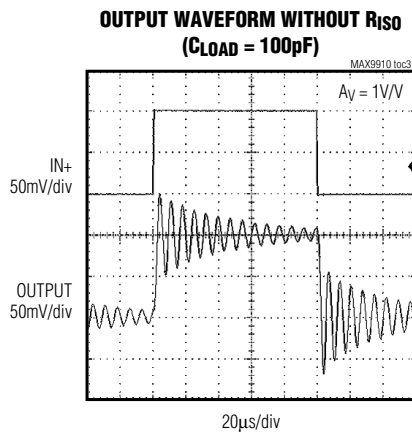
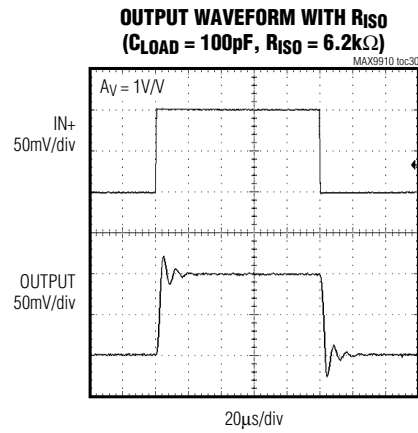
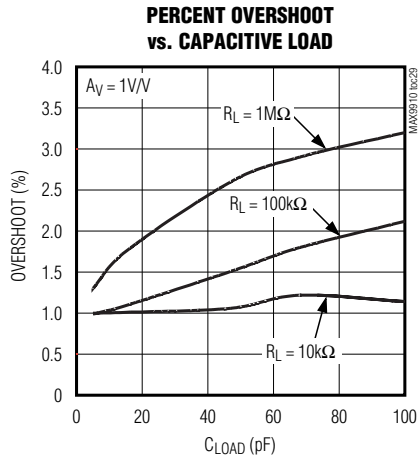
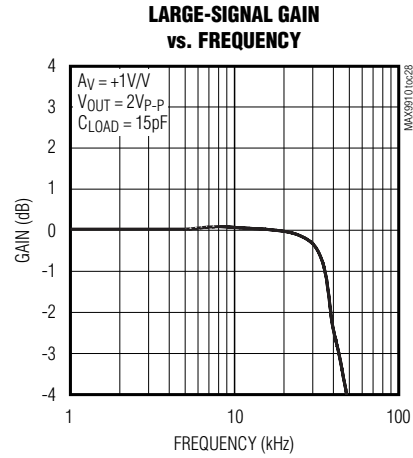
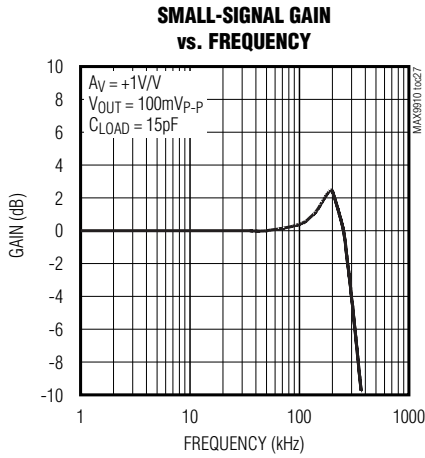

200kHz, 4 μ A, Rail-to-Rail I/O Op Amps with Shutdown

Pin Description

PIN					NAME	FUNCTION
MAX9911 (WLP)	MAX9910	MAX9911 (SC70)	MAX9912	MAX9913		
A1	1	1	—	—	IN+	Noninverting Amplifier Input
A2	2	2	4	4	V _{SS}	Negative Supply Voltage
B1	3	3	—	—	IN-	Inverting Amplifier Input
C1	4	4	—	—	OUT	Amplifier Output
B2	5	6	8	10	V _{DD}	Positive Supply Voltage
C2	—	5	—	—	$\overline{\text{SHDN}}$	Shutdown
—	—	—	1	1	OUTA	Amplifier Output Channel A
—	—	—	2	2	INA-	Inverting Amplifier Input Channel A
—	—	—	3	3	INA+	Noninverting Amplifier Input Channel A
—	—	—	—	5	$\overline{\text{SHDNA}}$	Shutdown Channel A
—	—	—	—	6	$\overline{\text{SHDNB}}$	Shutdown Channel B
—	—	—	5	7	INB+	Noninverting Amplifier Input Channel B
—	—	—	6	8	INB-	Inverting Amplifier Input Channel B
—	—	—	7	9	OUTB	Amplifier Output Channel B

MAX9910-MAX9913

Detailed Description

Featuring a maximized ratio of GBW to supply current, low operating supply voltage, low input bias current, and rail-to-rail inputs and outputs, the MAX9910-MAX9913 are an excellent choice for precision or general-purpose, low-current, low-voltage, battery-powered applications. These CMOS devices consume an ultra-low 4 μ A (typ) supply current and a 200 μ V (typ) offset voltage. For additional power conservation, the MAX9911/MAX9913 feature a low-power shutdown mode that reduces supply current to 1nA (typ), and puts the amplifiers' output in a high-impedance state. These devices are unity-gain stable with a 200kHz GBW product, driving capacitive loads up to 30pF. The capacitive load can be increased to 250pF when the amplifier is configured for a 10V/V gain.

Rail-to-Rail Inputs and Outputs

All of the MAX9910-MAX9913 amplifiers have a parallel-connected n- and p-channel differential input stage that allows an input common-mode voltage range that extends 100mV beyond the positive and negative supply rails, with excellent common-mode rejection.

The MAX9910-MAX9913 are capable of driving the output to within 5mV of both supply rails with a 100k Ω

load. These devices can drive a 5k Ω load with swings to within 60mV of the rails. Figure 1 shows the output voltage swing of the MAX9910-MAX9913 configured as a unity-gain buffer powered from a single 3V supply.

Low Input Bias Current

The MAX9910-MAX9913 feature ultra-low 1pA (typ) input bias current. The variation in the input bias current is minimal with changes in the input voltage due to very high input impedance (in the order of 1G Ω).

Applications Information

Driving Capacitive Loads

The MAX9910-MAX9913 amplifiers are unity-gain stable for loads up to 30pF. However, the capacitive load can be increased to 250pF when the amplifier is configured for a minimum gain of 10V/V. Applications that require greater capacitive-drive capability should use an isolation resistor between the output and the capacitive load (Figure 2). Also, in unity-gain applications with relatively small R_L (approximately 5k Ω), the capacitive load can be increased up to 200pF.

Power-Supply Considerations

The MAX9910-MAX9913 are optimized for single 1.8V to 5.5V supply operation. A high amplifier power-supply

200kHz, 4μA, Rail-to-Rail I/O Op Amps with Shutdown

rejection ratio of 95dB (typ) allows the devices to be powered directly from a battery, simplifying design and extending battery life.

Power-Up Settling Time

The MAX9910-MAX9913 typically require 5μs after power-up. Supply settling time depends on the supply voltage, the value of the bypass capacitor, the output impedance of the incoming supply, and any lead resistance or inductance between components. Op-amp settling time depends primarily on the output voltage and is slew-rate limited. Figure 3 shows the MAX991_ in a noninverting voltage follower configuration with the input held at midsupply. The output settles in approximately 18μs for V_{DD} = 3V (see the *Typical Operating Characteristics* for power-up settling time).

Shutdown Mode

The MAX9911/MAX9913 feature active-low shutdown inputs. The MAX9911/MAX9913 enter shutdown in 2μs (typ) and exit in 30μs (typ). The amplifiers' outputs are in a high-impedance state in shutdown mode. Drive $\overline{\text{SHDN}}$ low to enter shutdown. Drive $\overline{\text{SHDN}}$ high to enable the amplifier. The MAX9913 dual-amplifier features separate shutdown inputs. Shut down both amplifiers for the lowest quiescent current.

Power-Supply Bypassing and Layout

To minimize noise, bypass V_{DD} with a 0.1μF capacitor to ground, as close to the pin as possible.

Good layout techniques optimize performance by decreasing the amount of stray capacitance and inductance to the op amps' inputs and outputs. Minimize stray capacitance and inductance by placing external components close to the IC.

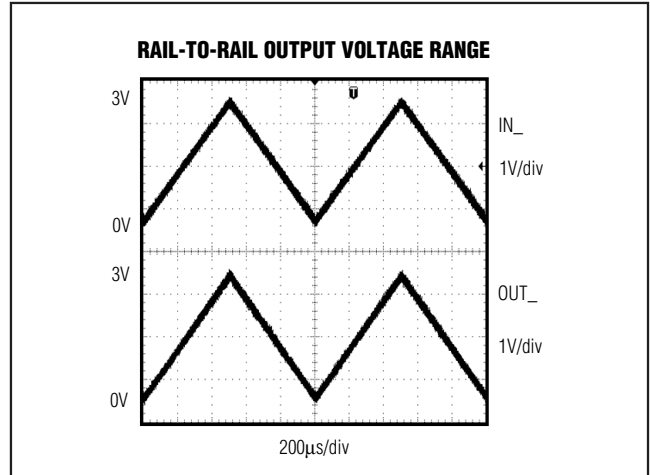

Figure 1. Rail-to-Rail Output Voltage Range

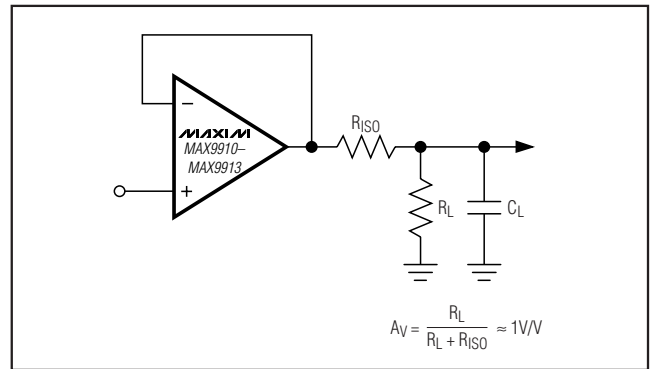

Figure 2. Using a Resistor to Isolate a Capacitive Load from the Op Amp

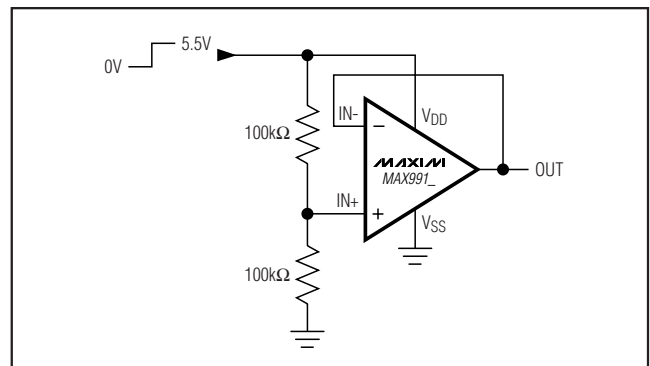
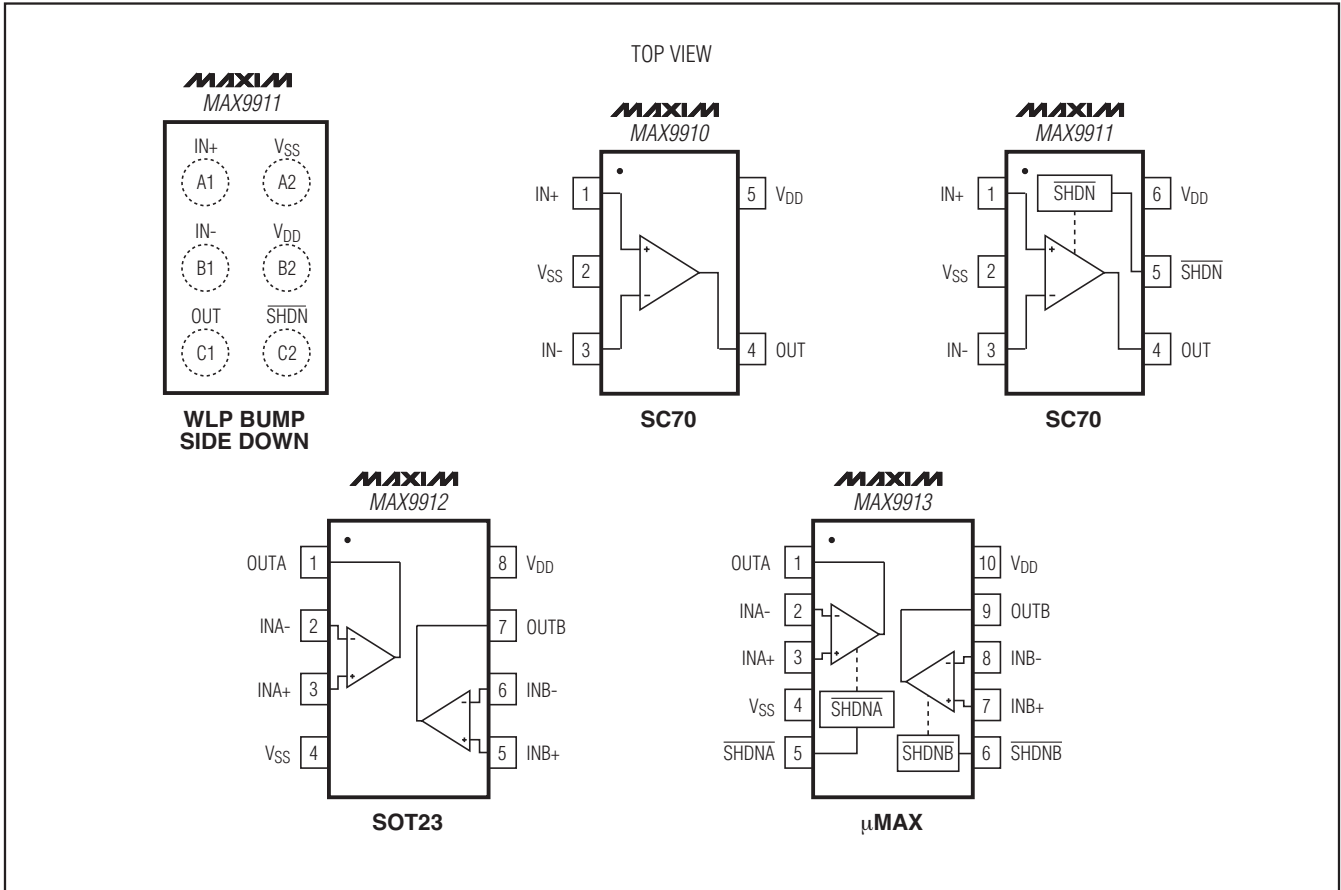

Figure 3. Power-Up Test Configuration

200kHz, 4 μ A, Rail-to-Rail I/O Op Amps with Shutdown

Pin Configurations

MAX9910-MAX9913



Chip Information

PROCESS: BiCMOS

200kHz, 4μA, Rail-to-Rail I/O Op Amps with Shutdown

Package Information

For the latest package outline information and land patterns, go to www.maxim-ic.com/packages. Note that a "+", "#", or "-" in the package code indicates RoHS status only. Package drawings may show a different suffix character, but the drawing pertains to the package regardless of RoHS status.

PACKAGE TYPE	PACKAGE CODE	OUTLINE NO.	LAND PATTERN NO.
5 SC70	X5+1	21-0076	90-0188
6 SC70	X6SN+1	21-0077	90-0189
6 WLP	W61B1+1	21-0217	—
8 SOT23	K8+5	21-0078	90-0176
10 μMAX	U10+2	21-0061	90-0330

COMMON DIMENSIONS			
SYMBOL	MIN	NOM	MAX
A	0.80	0.95	1.10
A1	0.00	0.07	0.10
A2	0.80	0.90	1.00
b	0.15	0.22	0.30
c	0.10	0.14	0.18
D	1.80	2.00	2.20
e	0.65 BSC.		
E	1.15	1.25	1.35
HE	1.80	2.20	2.40
L	0.26	0.34	0.46
L1	0.425 TYP.		
Q1	0.10	0.25	0.40
PKG. CODE	X5-1		

NOTES:

- ALL DIMENSIONS ARE IN MILLIMETERS.
- DIMENSIONS ARE INCLUSIVE OF PLATING.
- DIMENSIONS ARE EXCLUSIVE OF MOLD FLASH & METAL BURR.
- COMPLY TO JEITA SC-88A EXCEPT FOR DIMENSION "L". ALL DIMENSIONS COMPLY TO JEDEC MO-203.
- COPLANARITY 4 MILS. MAX.
- FOOT LENGTH MEASURED AT INTERCEPT POINT BETWEEN DATUM "A" AND LEAD SURFACE.
- MARKING IS FOR PACKAGE ORIENTATION REFERENCE ONLY.
- LEAD CENTERLINES TO BE AT TRUE POSITION AS DEFINED BY BASIC DIMENSION "e", ±0.05.

-DRAWING NOT TO SCALE-

DALLAS SEMICONDUCTOR		MAXIM	
TITLE: PACKAGE OUTLINE, 5L SC70			
APPROVAL	JUDGMENT CONTROL NO. 21-0076	REV. E	1/1

SC70, 5LEPS

200kHz, 4μA, Rail-to-Rail I/O Op Amps with Shutdown

Package Information (continued)

For the latest package outline information and land patterns, go to www.maxim-ic.com/packages. Note that a "+", "#", or "-" in the package code indicates RoHS status only. Package drawings may show a different suffix character, but the drawing pertains to the package regardless of RoHS status.

MAX9910-MAX9913

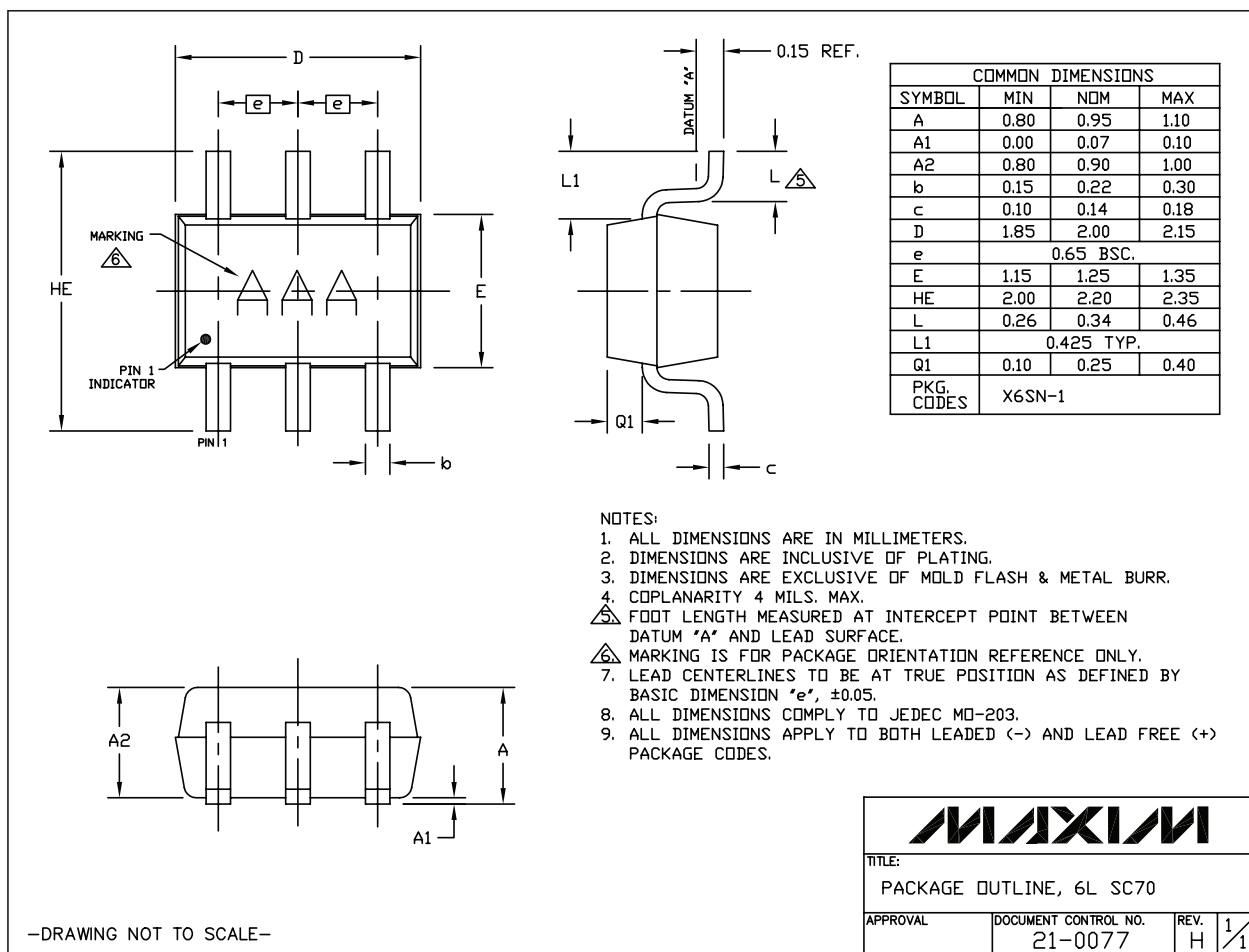

200kHz, 4μA, Rail-to-Rail I/O Op Amps with Shutdown

Package Information (continued)

For the latest package outline information and land patterns, go to www.maxim-ic.com/packages. Note that a "+", "#", or "-" in the package code indicates RoHS status only. Package drawings may show a different suffix character, but the drawing pertains to the package regardless of RoHS status.

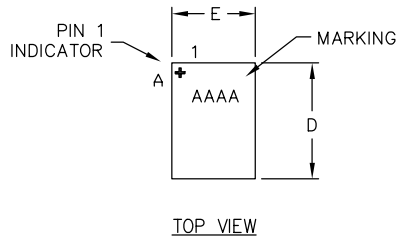

TOP VIEW

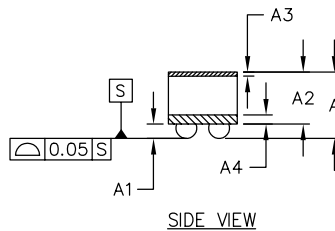

SIDE VIEW

COMMON DIMENSIONS	
A	0.64±0.05
A1	0.19±0.03
A2	0.45 REF
A3	0.025 BASIC
A4	0.07 BASIC
b	∅0.27±0.03
D1	0.80 BASIC
E1	0.40 BASIC
e	0.40 BASIC
SD	0.00 BASIC
SE	0.20 BASIC

PKG. CODE	E		D		DEPOPULATED BUMPS
	MIN	MAX	MIN	MAX	
W61B1+1	0.76	0.97	1.17	1.37	NONE
W61D1+1	0.95	1.02	1.36	1.42	NONE

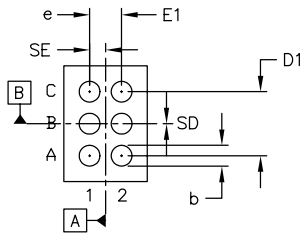

BOTTOM VIEW

NOTES:

1. Terminal pitch is defined by terminal center to center value.
2. Outer dimension is defined by center lines between scribe lines.
3. All dimensions in millimeters.
4. Marking shown is for package orientation reference only.
5. Tolerance is ± 0.02mm unless specified otherwise.
6. All dimensions apply to PbFree (+) package codes only.

-DRAWING NOT TO SCALE-

MAXIM			
TITLE: PACKAGE OUTLINE 6 BUMPS, WLP PKG. 0.4mm PITCH			
APPROVAL	DOCUMENT CONTROL NO. 21-0217	REV. B	1/1

200kHz, 4 μ A, Rail-to-Rail I/O Op Amps with Shutdown

Package Information (continued)

For the latest package outline information and land patterns, go to www.maxim-ic.com/packages. Note that a "+", "#", or "-" in the package code indicates RoHS status only. Package drawings may show a different suffix character, but the drawing pertains to the package regardless of RoHS status.

MAX9910-MAX9913

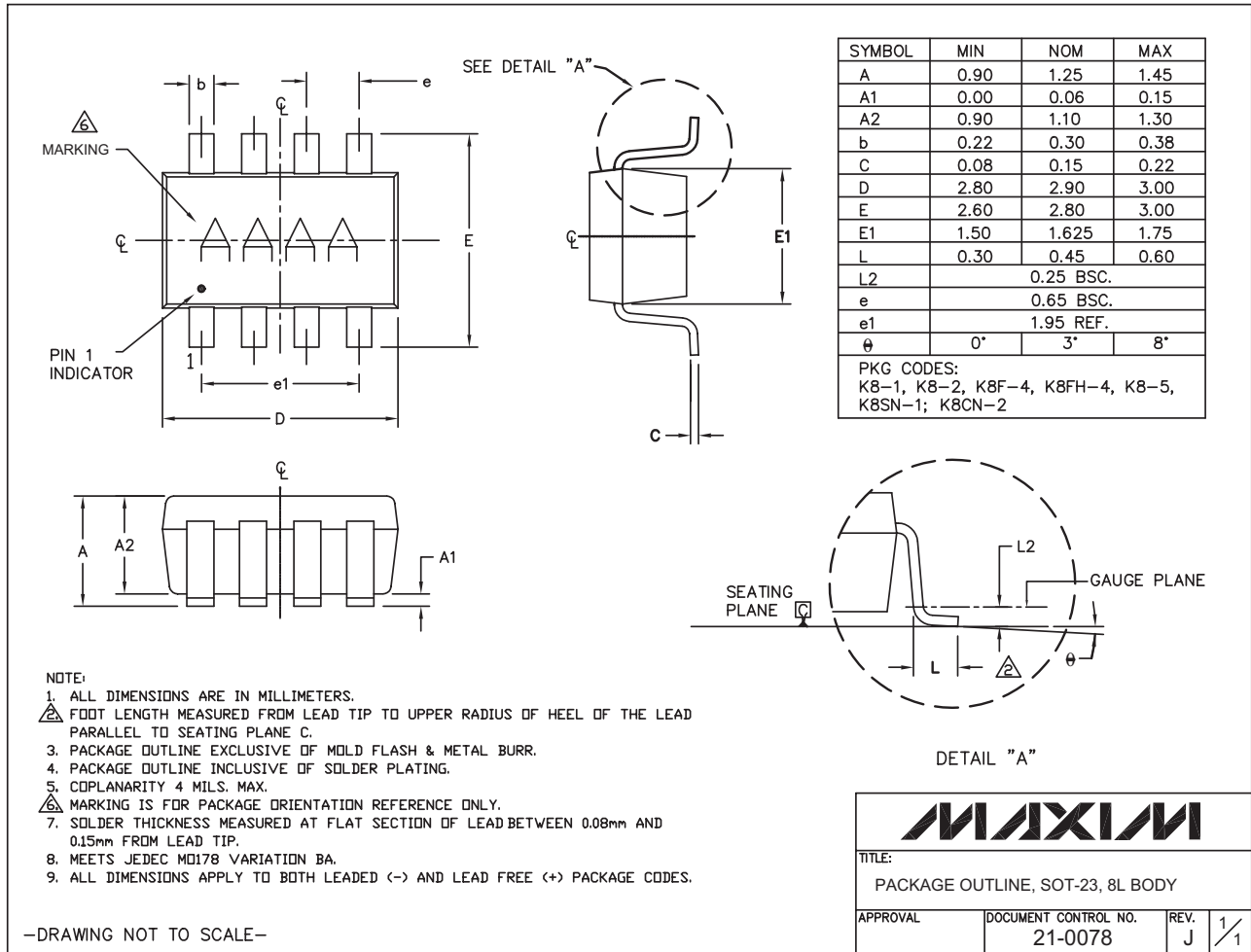

200kHz, 4μA, Rail-to-Rail I/O Op Amps with Shutdown

Package Information (continued)

For the latest package outline information and land patterns, go to www.maxim-ic.com/packages. Note that a "+", "#", or "-" in the package code indicates RoHS status only. Package drawings may show a different suffix character, but the drawing pertains to the package regardless of RoHS status.

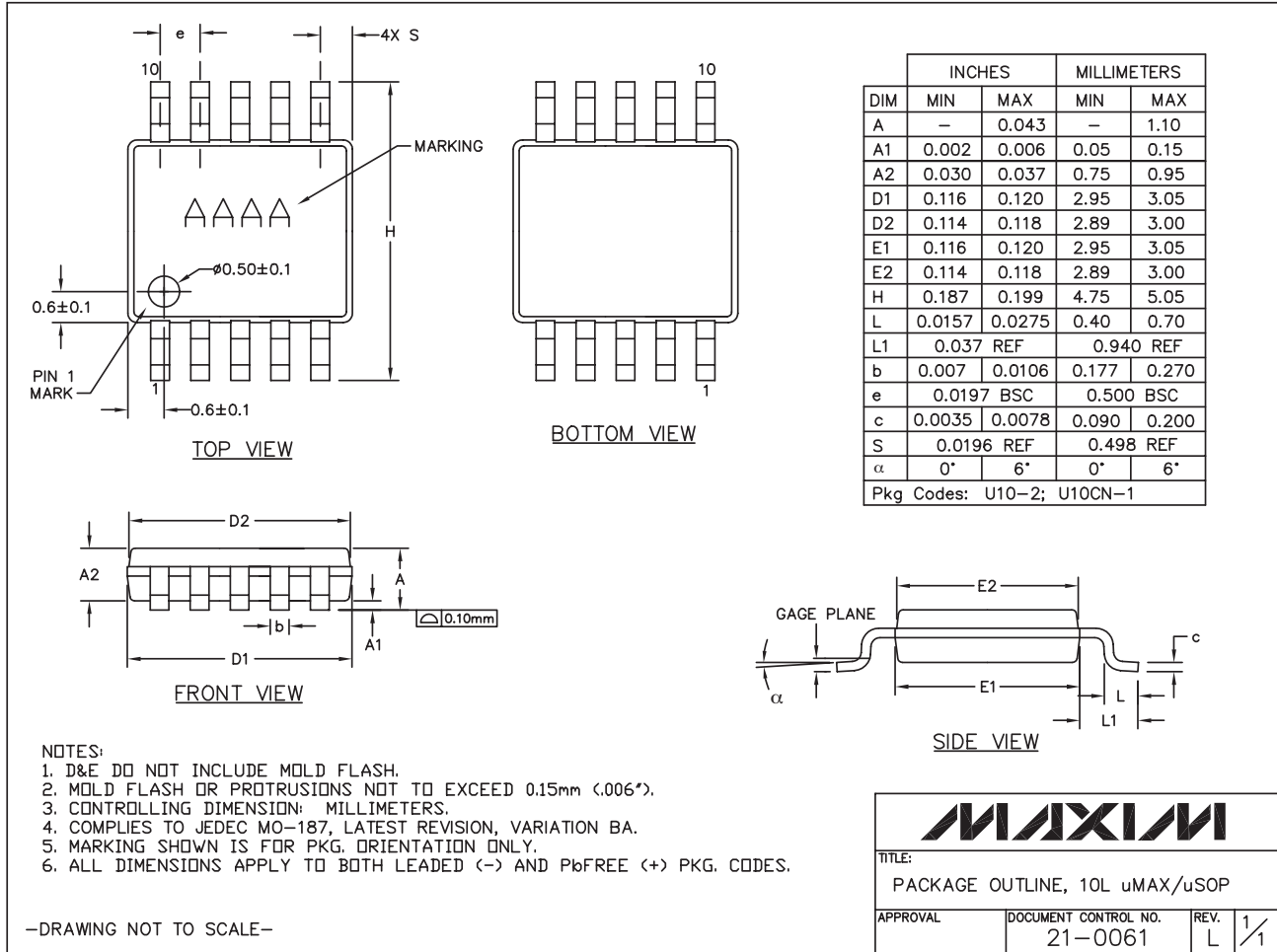

10L uMAX/εPS



TITLE: PACKAGE OUTLINE, 10L uMAX/uSOP			
APPROVAL	DOCUMENT CONTROL NO. 21-0061	REV. L	1/1

200kHz, 4 μ A, Rail-to-Rail I/O Op Amps with Shutdown

Revision History

REVISION NUMBER	REVISION DATE	DESCRIPTION	PAGES CHANGED
2	10/10	Added WLP package	1, 2, 9, 11

MAX9910-MAX9913

Maxim cannot assume responsibility for use of any circuitry other than circuitry entirely embodied in a Maxim product. No circuit patent licenses are implied. Maxim reserves the right to change the circuitry and specifications without notice at any time.

Maxim Integrated Products, 120 San Gabriel Drive, Sunnyvale, CA 94086 408-737-7600 _____ 17



Компания «ЭлектроПласт» предлагает заключение долгосрочных отношений при поставках импортных электронных компонентов на взаимовыгодных условиях!

Наши преимущества:

- Оперативные поставки широкого спектра электронных компонентов отечественного и импортного производства напрямую от производителей и с крупнейших мировых складов;
- Поставка более 17-ти миллионов наименований электронных компонентов;
- Поставка сложных, дефицитных, либо снятых с производства позиций;
- Оперативные сроки поставки под заказ (от 5 рабочих дней);
- Экспресс доставка в любую точку России;
- Техническая поддержка проекта, помощь в подборе аналогов, поставка прототипов;
- Система менеджмента качества сертифицирована по Международному стандарту ISO 9001;
- Лицензия ФСБ на осуществление работ с использованием сведений, составляющих государственную тайну;
- Поставка специализированных компонентов (Xilinx, Altera, Analog Devices, Intersil, Interpoint, Microsemi, Aeroflex, Peregrine, Syfer, Eurofarad, Texas Instrument, Miteq, Cobham, E2V, MA-COM, Hittite, Mini-Circuits, General Dynamics и др.);

Помимо этого, одним из направлений компании «ЭлектроПласт» является направление «Источники питания». Мы предлагаем Вам помощь Конструкторского отдела:

- Подбор оптимального решения, техническое обоснование при выборе компонента;
- Подбор аналогов;
- Консультации по применению компонента;
- Поставка образцов и прототипов;
- Техническая поддержка проекта;
- Защита от снятия компонента с производства.



Как с нами связаться

Телефон: 8 (812) 309 58 32 (многоканальный)

Факс: 8 (812) 320-02-42

Электронная почта: org@eplast1.ru

Адрес: 198099, г. Санкт-Петербург, ул. Калинина, дом 2, корпус 4, литера А.