

# Distinctive Characteristics

Double flatted bushing prevents rotation in panel and increases stability.

Totally sealed construction, achieved with combination of an interior o-ring, a seal between the frame and base, plus insert molded terminals, prevents contact contamination and allows automated soldering and cleaning.

Positive detent mechanism for distinct feel and audible feedback.

Break-before-make contact timing with sliding contact mechanism.

Metal bushing and frame/bracket provide durability.

Panel seal, achieved with use of optional exterior o-ring, conforms to IP67 of IEC60529 Standards.

High contact reliability achieved by the self-cleaning contact mechanism.

.100" x .100" (2.54mm x 2.54mm) terminal spacing conforms to standard PC board grid spacing for straight and right angle mounting.

Insert molded terminals lock out flux and other contaminants.



Actual Size



# General Specifications

## Electrical Capacity (Resistive Load)

**Logic Level:** 0.4VA maximum @ 28V AC/DC maximum  
 (Applicable Range 0.1mA ~ 0.1A @ 20mV ~ 28V)  
 Note: See Supplement Index to find explanation of operating range.

## Other Ratings

**Contact Resistance:** 80 milliohms maximum  
**Insulation Resistance:** 100 megohms minimum @ 500V DC  
**Dielectric Strength:** 500V AC minimum for 1 minute minimum  
**Mechanical Life:** 30,000 operations minimum  
**Electrical Life:** 10,000 operations minimum  
**Operating Torque:** 0.04Nm average  
**Contact Timing:** Nonshorting (break-before-make)  
**Indexing:** 45° for On-On-On & 90° for On-None-On

## Materials & Finishes

**Shaft:** Brass with nickel plating  
**Bushing:** Zinc alloy with nickel plating  
**Frame/Bracket:** Steel with tin plating  
**Movable Contacts:** Beryllium copper spring with gold plating  
**Stationary Contacts:** Copper with gold plating  
**Terminals:** Brass with tin plating  
**Base:** Polyamide

## Environmental Data

**Operating Temperature Range:** -10°C through +70°C (+14°F through +158°F)  
**Humidity:** 90 ~ 95% humidity for 96 hours @ 40°C (104°F)  
**Vibration:** 10 ~ 55Hz with peak-to-peak amplitude of 1.5mm traversing the frequency range & returning in 1 minute; 3 right angled directions for 2 hours  
**Shock:** 50G (490m/s<sup>2</sup>) acceleration (tested in 3 right angled directions, with 5 shocks in each direction)

## Installation

**Mounting Torque:** .686Nm (6.08 lb•in)  
**Cap Installation Force:** 19.6 ~ 29.4N (4.41 ~ 6.61 lbf)

## PCB Processing

**Soldering:** Wave Soldering Recommended: See Profile B in Supplement section  
 Manual Soldering: See Profile B in Supplement section  
**Cleaning:** Automated cleaning. See Cleaning specifications in Supplement section.

## Standards & Certifications

**UL Recognition or CSA Certification:** The MRB Series rotaries have not been tested for UL recognition or CSA certification. These switches are designed for use in a low-voltage, low-current, logic-level circuit. When used as intended in a logic-level circuit, the results do not produce hazardous energy.

### TYPICAL SWITCH ORDERING EXAMPLE

**MRB**    **1**    **2**    **B**    —    **A**   

POLES	
1	SPDT SP3T
2	DPDT DP3T

TERMINALS	
B	Straight with Bracket
H	Right Angle with Bracket

KNOBS	
A	Plain Black
B	Small Color Tipped
C	Large Color Tipped

COLORS	
For Plain Knob	
No Code	Black
For Color Tipped	
A	Black
B	White
C	Red
E	Yellow
F	Green
G	Blue
H	Gray

CIRCUITS & INDEXING				
2	ON	NONE	ON	90°
4	ON	ON	ON	45°

**DESCRIPTION FOR TYPICAL ORDERING EXAMPLE**

**MRB12B-A**

Plain Black Knob

SPDT with ON-NONE-ON Circuit & 90° Indexing

Straight PC Terminals with Bracket

### POLES & CIRCUITS

Pole	Model	Actuator Positions			Connected Terminals			Throw & Schematics
		Position 1	Position 2	Position 3	Position 1	Position 2	Position 3	
SP	MRB12	ON	NONE	ON	C1-1	OPEN	C1-2	SPDT 
	MRB14	ON	ON	ON	C1-1	C1-2	C1-3	SP3T 
DP	MRB22	ON	NONE	ON	C1-1 C2-4	OPEN	C1-2 C2-5	DPDT 
	MRB24	ON	ON	ON	C1-1 C2-4	C1-2 C2-5	C1-3 C2-6	DP3T 

Note: Terminal numbers are not actually on switch

### TERMINALS

**B** Straight PC Terminals with Bracket

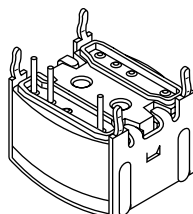

SPDT

**H** Right Angle PC Terminals with Bracket

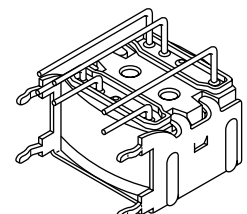

DPDT

### TYPICAL SWITCH DIMENSIONS

#### 90° Indexing • SPDT & DPDT • Straight PC

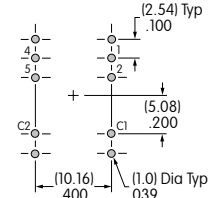
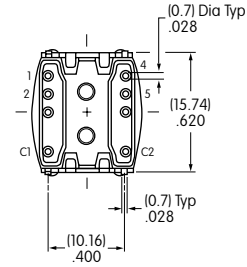
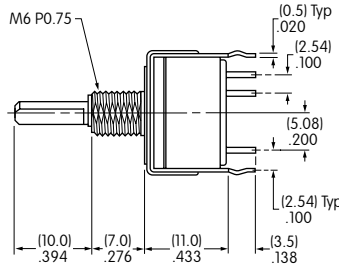
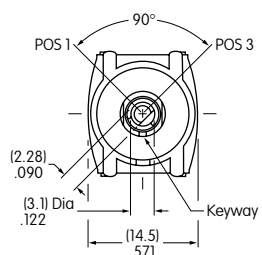

MRB12B

Actuator shown in Position 1

Single pole model does not have terminals 4, 5 & C2

#### 90° Indexing • SPDT • Right Angle PC

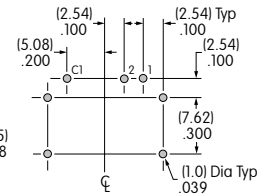
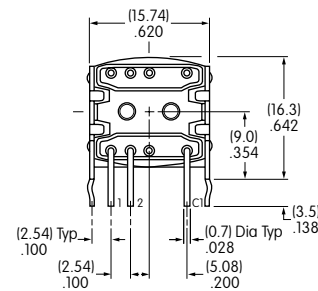
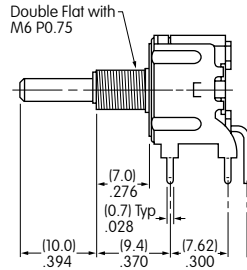
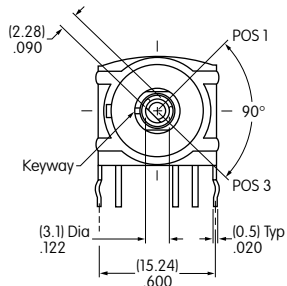

MRB12H

Actuator shown in Position 1

#### 90° Indexing • DPDT • Right Angle PC

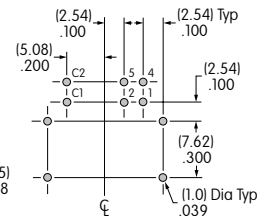
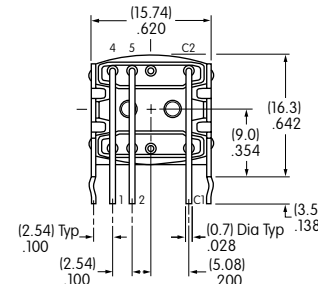
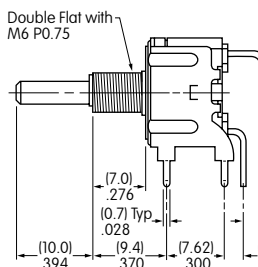
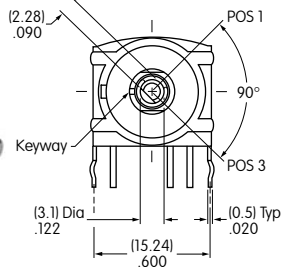

MRB22H

Actuator shown in Position 1

#### 45° Indexing • SP3T & DP3T • Straight PC

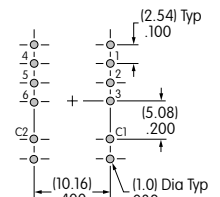
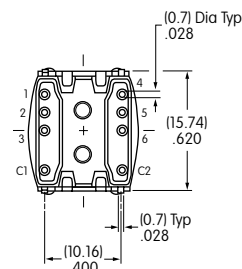
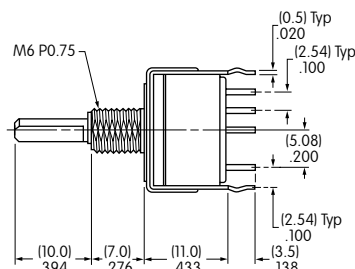

MRB14B

Actuator shown in Position 1

Single pole model does not have terminals 4, 5, 6 & C2

### TYPICAL SWITCH DIMENSIONS

#### 45° Indexing • SP3T • Right Angle PC

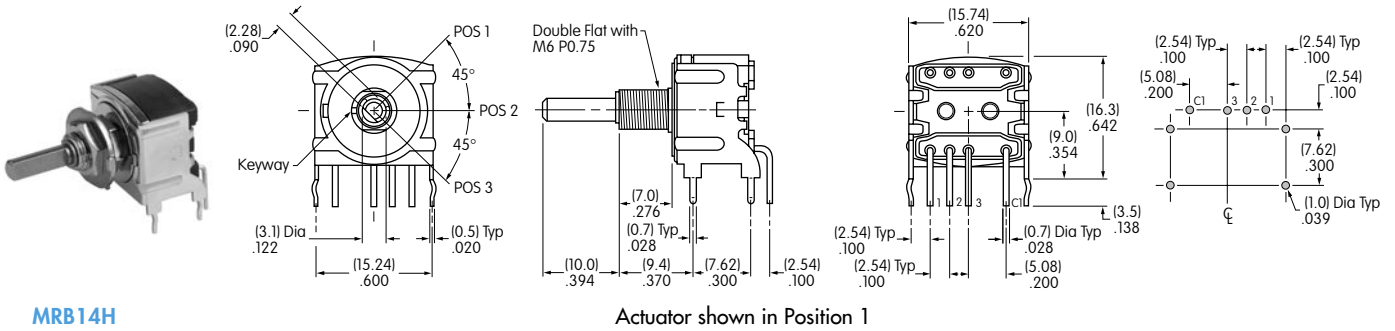

#### 45° Indexing • DP3T • Right Angle PC

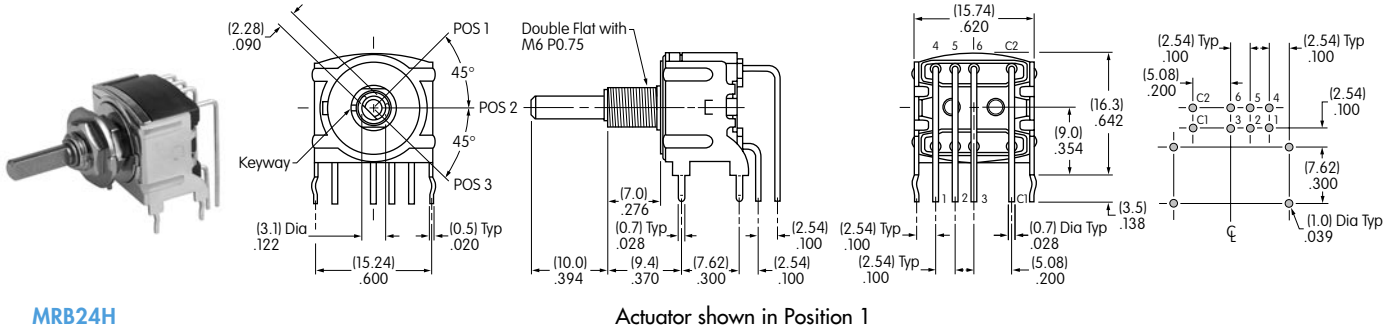

### KNOBS

#### A AT433 Plain Black

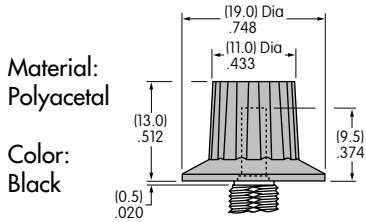

#### B AT4103 Small Color Tipped

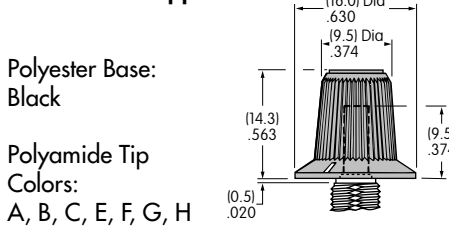

#### C AT4104 Large Color Tipped

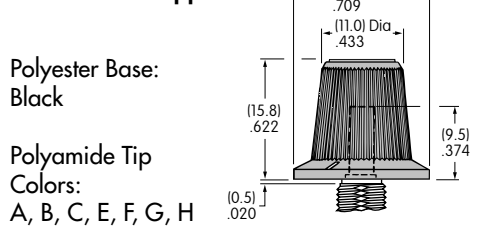

Color Codes: **A** Black   **B** White   **C** Red   **E** Yellow   **F** Green   **G** Blue   **H** Gray

#### Shaft Detail

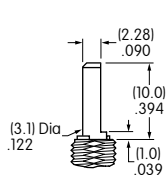

#### Mounting Precaution for Cap Clearance on Right Angle Models

When mounting a right angle switch, a cap clearance of .035" (0.9mm) is recommended.

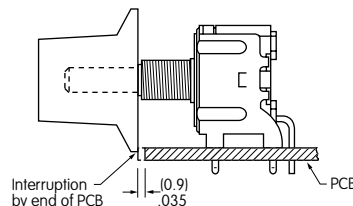

#### Standard Hardware Supplied

- AT513M Hex Nut
- AT507M Locking Ring
- AT509 Lockwasher

#### Optional Hardware

- AT535 O-ring for Panel Seal
- See Supplement for details

### PANEL CUTOUTS & MAXIMUM EFFECTIVE PANEL THICKNESS

With Standard Hardware  
.087" (2.2mm)

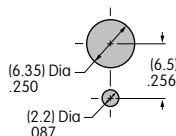

Without Locking Ring  
.118" (3.0mm)

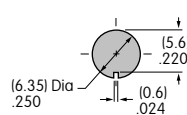

Sealed Panel with 2 Hex Nuts & 1 Rubber O-ring  
.165" (4.2mm)

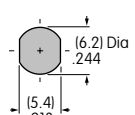



Компания «ЭлектроПласт» предлагает заключение долгосрочных отношений при поставках импортных электронных компонентов на взаимовыгодных условиях!

Наши преимущества:

- Оперативные поставки широкого спектра электронных компонентов отечественного и импортного производства напрямую от производителей и с крупнейших мировых складов;
- Поставка более 17-ти миллионов наименований электронных компонентов;
- Поставка сложных, дефицитных, либо снятых с производства позиций;
- Оперативные сроки поставки под заказ (от 5 рабочих дней);
- Экспресс доставка в любую точку России;
- Техническая поддержка проекта, помощь в подборе аналогов, поставка прототипов;
- Система менеджмента качества сертифицирована по Международному стандарту ISO 9001;
- Лицензия ФСБ на осуществление работ с использованием сведений, составляющих государственную тайну;
- Поставка специализированных компонентов (Xilinx, Altera, Analog Devices, Intersil, Interpoint, Microsemi, Aeroflex, Peregrine, Syfer, Eurofarad, Texas Instrument, Miteq, Cobham, E2V, MA-COM, Hittite, Mini-Circuits, General Dynamics и др.);

Помимо этого, одним из направлений компании «ЭлектроПласт» является направление «Источники питания». Мы предлагаем Вам помощь Конструкторского отдела:

- Подбор оптимального решения, техническое обоснование при выборе компонента;
- Подбор аналогов;
- Консультации по применению компонента;
- Поставка образцов и прототипов;
- Техническая поддержка проекта;
- Защита от снятия компонента с производства.



#### Как с нами связаться

**Телефон:** 8 (812) 309 58 32 (многоканальный)

**Факс:** 8 (812) 320-02-42

**Электронная почта:** [org@eplast1.ru](mailto:org@eplast1.ru)

**Адрес:** 198099, г. Санкт-Петербург, ул. Калинина, дом 2, корпус 4, литера А.