

# General Specifications

## Electrical Capacity (Resistive Load)

**Logic Level:** 0.4VA maximum @ 28V AC/DC maximum  
(Applicable Range 0.1mA ~ 0.1A @ 20mV ~ 28V)  
Note: Find additional explanation of operating range in Supplement section.

## Other Ratings

**Contact Resistance:** 80 milliohms maximum  
**Insulation Resistance:** 500 megohms minimum @ 500V DC  
**Dielectric Strength:** 500V AC minimum for 1 minute minimum  
**Mechanical Life:** 100,000 operations minimum  
**Electrical Life:** 100,000 operations minimum  
10,000 operations minimum @ 0.1A @ 28V AC/DC  
**Nominal Operating Force:** 1.30N  
**Angle of Throw:** 28°

## Materials & Finishes

**Actuator:** Polyamide  
**Case:** Glass fiber reinforced polyamide  
**Sealing Rings:** Nitrile butadiene rubber  
**Movable Contacts:** Phosphor bronze with gold plating  
**Stationary Contacts:** Phosphor bronze with gold plating  
**Base:** Glass fiber reinforced polyamide  
**Power Terminals:** Phosphor bronze with gold plating  
**Lamp Terminals:** Phosphor bronze with gold plating

## Environmental Data

**Operating Temperature Range:** -25°C through +55°C (-13°F through +131°F)  
**Humidity:** 90 ~ 95% humidity for 240 hours @ 40°C (104°F)  
**Vibration:** 10 ~ 500Hz with peak-to-peak amplitude of 1.5mm traversing the frequency range & returning in 1 minute; 3 right angled directions for 2 hours  
**Shock:** 50G (490m/s<sup>2</sup>) acceleration (tested in 6 right angled directions, with 5 shocks in each direction)

## PCB Processing

**Soldering:** Wave Soldering recommended. See Profile A in Supplement section.  
Manual Soldering: See Profile A in Supplement section.  
**Cleaning:** Automated cleaning. See Cleaning specifications in Supplement section.

## Standards & Certifications

The G Series toggles have not been tested for UL recognition or CSA certification. These switches are designed for use in a low-voltage, low-current, logic-level circuit. When used as intended in a logic-level circuit, the results do not produce hazardous energy.

# Distinctive Characteristics

Fully illuminated toggle for highly visible status indication with LED in red, green, or amber for single color and red/green for bicolor.

Ultra-miniature size allows high density mounting, and extremely light weight makes these switches ideal for handheld equipment.

Totally sealed body construction prevents contact contamination and allows time- and money-saving automated soldering and cleaning.

Molded-in, epoxy sealed terminals lock out flux, solvents, and other contaminants.

Award-winning STC contact mechanism with benefits unavailable in conventional mechanisms: smooth, positive detent actuation, increased contact stability, and unparalleled logic-level reliability. (Additional STC details in Terms & Acronyms; see Supplement section.)

.100" x .100" (2.54mm x 2.54mm) terminal spacing conforms to standard PC board grid spacing. Round terminals facilitate easier through-hole mounting on PC boards.

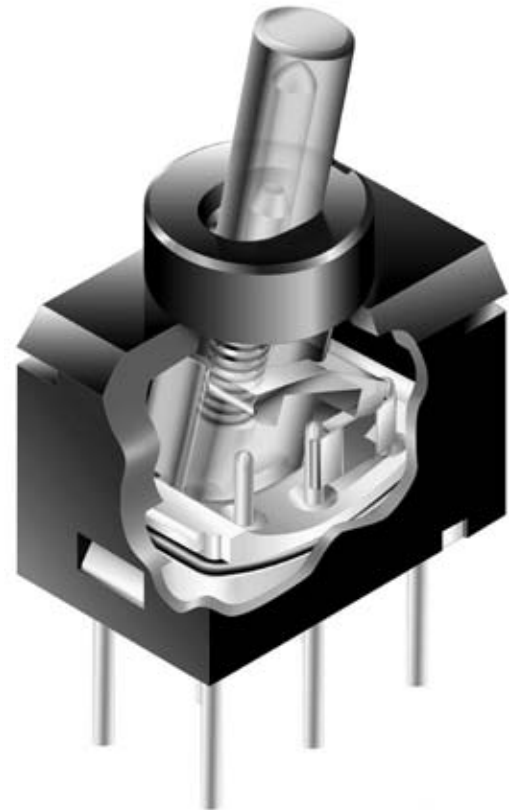

Actual Size

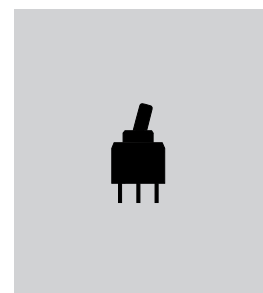

A

Toggles

Rockers

Pushbuttons

Illuminated PB

Programmable

Keylocks

Rotaries

Slides

Tactiles

Tilt

Touch

Indicators

Accessories

Supplement

### TYPICAL SWITCH ORDERING EXAMPLE

<b>G</b>	<b>1</b>	<b>2</b>	<b>J</b>	<b>H</b>	<b>C</b>	
<b>Pole</b>	<b>Circuits</b>			<b>Actuator</b>	<b>PC Terminals</b>	<b>LEDS</b>
1   SPDT	2   ON   NONE   ON	Clear			P   Straight	<b>Single Color</b>
	Combines with single color or bicolor LEDs				H   Right Angle	C   Red
	3   ON   OFF   ON				V   Vertical	D   Amber
	Combines with bicolor LED only					F   Green
						ON-NONE-ON only
						<b>Bicolor</b>
						CF   Red/Green
						ON-NONE-ON & ON-OFF-ON

**DESCRIPTION FOR TYPICAL ORDERING EXAMPLE**  
**G12JHC**

SPDT — ON-NONE-ON Circuit — Clear Toggle, Red LED — Right Angle PC Terminals

### POLES & CIRCUITS

Pole Throw	Model	Toggle Position			Connected Terminals			Schematics		
		Up	Center	Down	Up	Center	Down	Note: Terminal numbers are not actually on the switch. LED circuit is isolated and requires an external power source.		
SPDT	G12 G13	ON ON	NONE OFF	ON ON	2-3 2-3	NONE OPEN	2-1 2-1	 Single Color	 Bicolor	

### ACTUATOR

**J** Clear Toggle

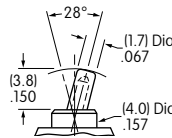

### LED COLORS & SPECIFICATIONS

	Colors	Single Color			Bicolor
		<b>C</b> Red	<b>D</b> Amber	<b>F</b> Green	<b>CF</b> Red/Green
LEDs are an integral part of the switch and not available separately. The electrical specifications shown are determined at a basic temperature of 25°C.					
Forward Peak Current	$I_{FM}$	30mA	30mA	25mA	30mA/25mA
Typical Forward Current	$I_F$	20mA	20mA	20mA	20mA/20mA
Forward Voltage	$V_F$	2.0V	2.0V	2.1V	2.0V/2.1V
Reverse Peak Voltage	$V_{RM}$	5V	5V	5V	5V/5V
Current Reduction Rate Above 25°C	$\Delta I_F$	0 - No current Reduction Rate within Ambient Temperature Range			
Ambient Temperature Range		-25° ~ +55°C			

If the source voltage exceeds the rated voltage, a ballast resistor is required.

The resistor value can be calculated by using the formula in the Supplement; see Supplement Index.

## PC TERMINALS

A  
Toggles

**P** Straight

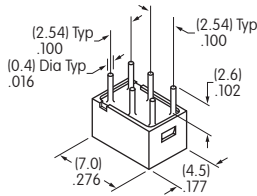

**H** Right Angle

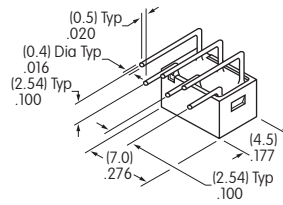

**V** Vertical

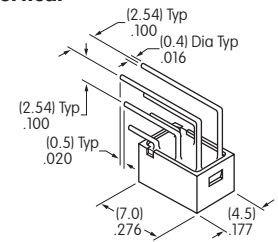

## TYPICAL SWITCH DIMENSIONS

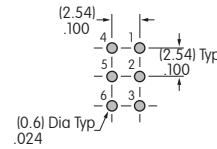
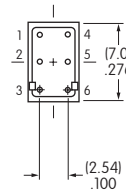
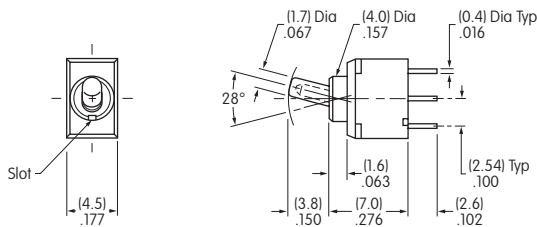

**Straight PC**



5 & 6 are LED terminals; 4 is a support pin on single color models & an LED terminal on bicolor models.

**G12JPC**

**Right Angle PC**

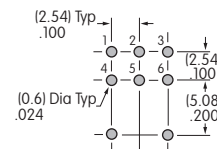
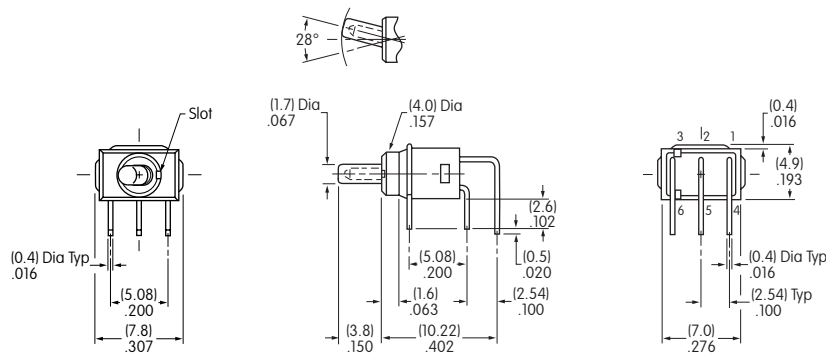

5 & 6 are LED terminals; 4 is a support pin on single color models & an LED terminal on bicolor models.

**G12JHD**

**Vertical PC**

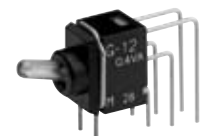
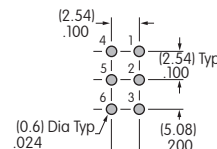
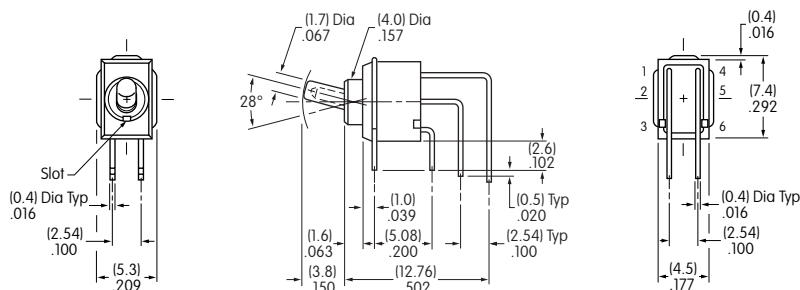

5 & 6 are LED terminals; 4 is a support pin on single color models & an LED terminal on bicolor models.

**G12JVCF**

Rockers  
Pushbuttons  
Illuminated PB  
Programmable  
Keylocks  
Rotaries  
Slides  
Tactiles  
Tilt  
Touch  
Indicators  
Accessories  
Supplement



Компания «ЭлектроПласт» предлагает заключение долгосрочных отношений при поставках импортных электронных компонентов на взаимовыгодных условиях!

Наши преимущества:

- Оперативные поставки широкого спектра электронных компонентов отечественного и импортного производства напрямую от производителей и с крупнейших мировых складов;
- Поставка более 17-ти миллионов наименований электронных компонентов;
- Поставка сложных, дефицитных, либо снятых с производства позиций;
- Оперативные сроки поставки под заказ (от 5 рабочих дней);
- Экспресс доставка в любую точку России;
- Техническая поддержка проекта, помощь в подборе аналогов, поставка прототипов;
- Система менеджмента качества сертифицирована по Международному стандарту ISO 9001;
- Лицензия ФСБ на осуществление работ с использованием сведений, составляющих государственную тайну;
- Поставка специализированных компонентов (Xilinx, Altera, Analog Devices, Intersil, Interpoint, Microsemi, Aeroflex, Peregrine, Syfer, Eurofarad, Texas Instrument, Miteq, Cobham, E2V, MA-COM, Hittite, Mini-Circuits, General Dynamics и др.);

Помимо этого, одним из направлений компании «ЭлектроПласт» является направление «Источники питания». Мы предлагаем Вам помощь Конструкторского отдела:

- Подбор оптимального решения, техническое обоснование при выборе компонента;
- Подбор аналогов;
- Консультации по применению компонента;
- Поставка образцов и прототипов;
- Техническая поддержка проекта;
- Защита от снятия компонента с производства.



#### Как с нами связаться

**Телефон:** 8 (812) 309 58 32 (многоканальный)

**Факс:** 8 (812) 320-02-42

**Электронная почта:** [org@eplast1.ru](mailto:org@eplast1.ru)

**Адрес:** 198099, г. Санкт-Петербург, ул. Калинина, дом 2, корпус 4, литера А.