

## 3-INPUT / 2-INPUT VIDEO SWITCH

### ■ GENERAL DESCRIPTION

The **NJM2508** is video switch for video and audio signal. It contains 3 input-1 output and 2 input-1 output video switch. One input terminal has clamp function and so is applied to fixed DC level of video signal. Its operating voltage is 4.75 to 13V and bandwidth is 10MHz. Crosstalk is 75dB (at  $f = 4.43\text{MHz}$ )

### ■ PACKAGE OUTLINE

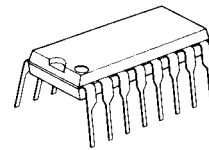

**NJM2508D**

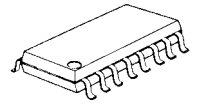

**NJM2508M**

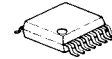

**NJM2508V**

### ■ FEATURES

- Operating Voltage (+4.75V to +13V)
- 3 Input-1 Output and 2 Input-1 Output
- Crosstalk 75dB (at 4.43MHz)
- Wide Frequency Range 10MHz (2V<sub>P-P</sub> Input)
- Package Outline DIP16, DMP16, SSOP16
- Bipolar Technology

### ■ RECOMMENDED OPERATING CONDITION

- Operating Voltage  $V^+$  4.75V to 13.0V

### ■ APPLICATION

- VCR, Video Camera, AV-TV, Video Disk Player.

### ■ BLOCK DIAGRAM

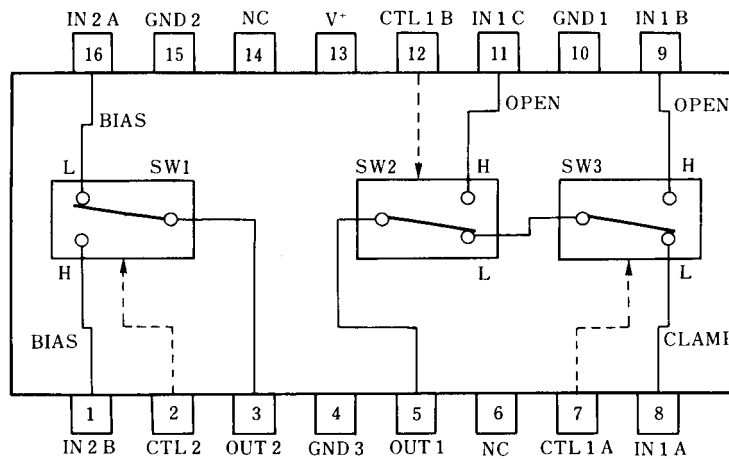

**NJM2508D**  
**NJM2508M**  
**NJM2508V**

# NJM2508

## ■ ABSOLUTE MAXIMUM RATINGS

( $T_a = 25^\circ\text{C}$ )

PARAMETER	SYMBOL	RATINGS	UNIT
Supply Voltage	$V^+$	14	V
Power Dissipation	$P_D$	(DIP16) 700 (DMP16) 350 (SSOP16) 300	mW mW mW
Operating Temperature Range	$T_{opr}$	-40 to +85	$^\circ\text{C}$
Storage Temperature Range	$T_{stg}$	-40 to +125	$^\circ\text{C}$

## ■ ELECTRICAL CHARACTERISTICS

( $V^+ = 5\text{V}$ ,  $T_a = 25^\circ\text{C}$ )

PARAMETER	SYMBOL	TEST CONDITION	MIN.	TYP.	MAX.	UNIT
Operating Current 1	$I_{CC1}$	$V^+ = 5\text{V}$ (Note1)	6.6	9.4	12.3	mA
Operating Current 2	$I_{CC2}$	$V^+ = 9\text{V}$ (Note1)	8.0	11.5	15.0	mA
Voltage Gain	$G_V$	$V_I = 2V_{P.P.}/100\text{kHz}$ , $V_O / V_I$	-0.6	-0.1	+0.4	dB
Frequency Response	$G_f$	$V_I = 2V_{P.P.}$ , $V_O$ (10MHz / 100kHz)	-1.0	0	+1.0	dB
Differential Gain	DG	$V_I = 2V_{P.P.}$ , Staircase Signal	-	0.3	-	%
Differential Phase	DP	$V_I = 2V_{P.P.}$ , Staircase Signal	-	0.3	-	deg
Output offset Voltage	$V_{OS}$	(Note2)	-10	0	+10	mV
Crosstalk	CT	$V_I = 2V_{P.P.}$ , 4.43MHz, $V_O / V_I$	-	-75	-	dB
Switch Change Voltage	$V_{CH}$	All inside SW : ON	2.5	-	-	V
Switch Change Voltage	$V_{CL}$	All inside SW : OFF	-	-	1.0	V

(Note1)  $S1 = S2 = S3 = S4 = S5 = S6 = S7 = 1$

(Note2) Output DC Voltage Difference is tested on  $S6 = 1 \rightarrow 2$ ,  $S1 = S2 = S3 = S4 = S5 = 1$ ,  $S8 = 2$  and  $S7 = 1$

## ■ TEST CIRCUIT

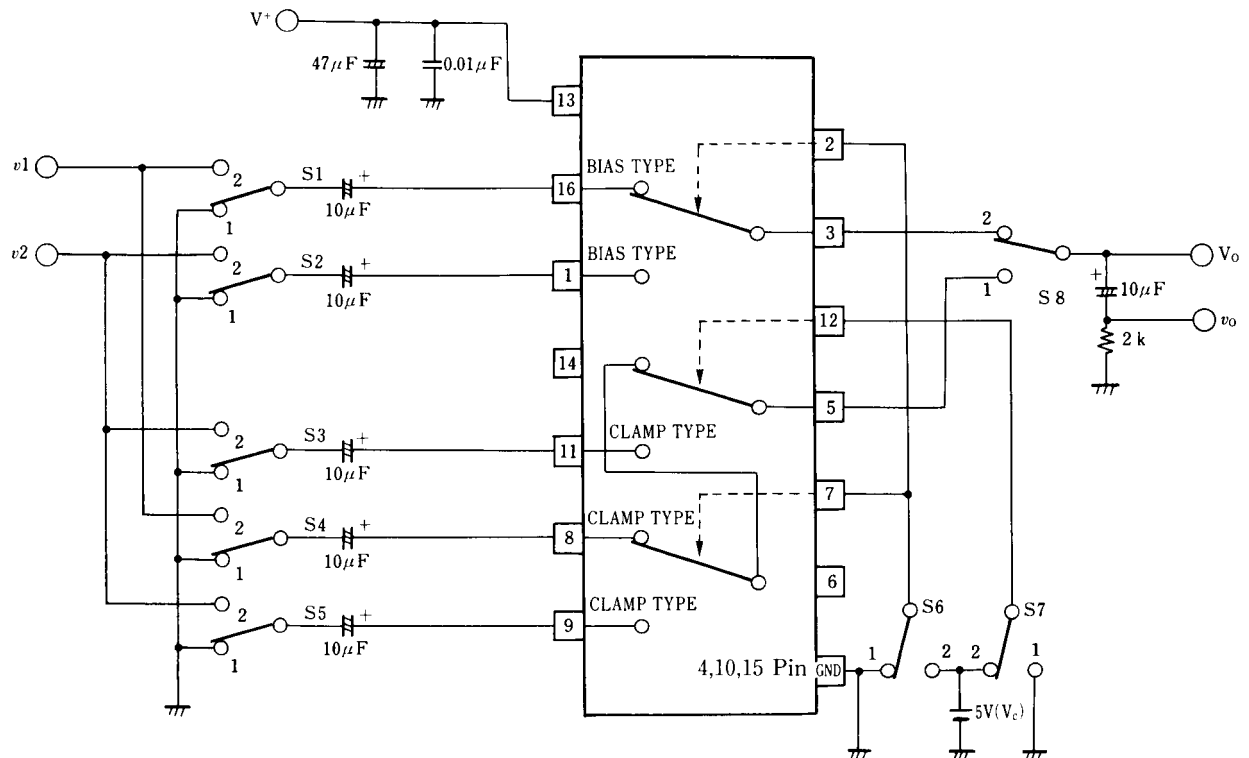

## ■ PIN FUNCTION

PIN No.	PIN NAME	DC VOLTAGE	INSIDE EQUIVALENT CIRCUIT
16 1	IN 2 A IN 2 B [Input]	2.5V	
8	IN 1 A [Input]	1.5V	
9 11	IN 1 B IN 1 C [Input]		
7 12 2	CTL 1 A CTL 1 B CTL 2 [Control]		
5	OUT1 [Output]	1.8V	
3	OUT2 [Output]	0.8V	
13	V <sup>+</sup>	5V	
15 4 10	GND 1 GND 2 GND 3		

## ■ TYPICAL CHARACTERISTICS (Ta = +25°C)

### Operating Current vs. Operating Voltage

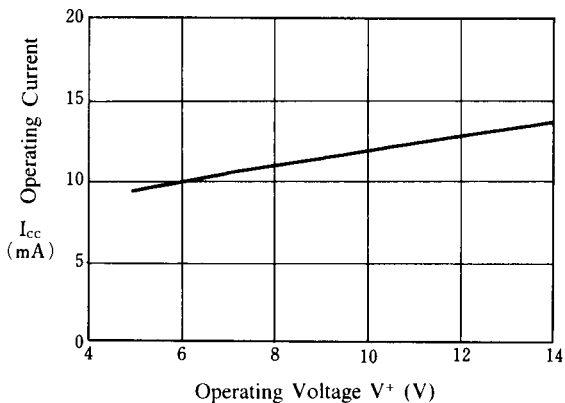

### Operating Current vs. Ambient Temperature (V<sup>+</sup> = 5 V)

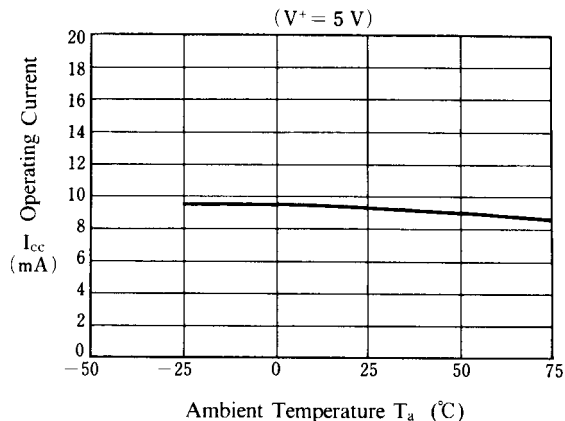

### Operating Current vs. Ambient Temperature (V<sup>+</sup> = 9 V)

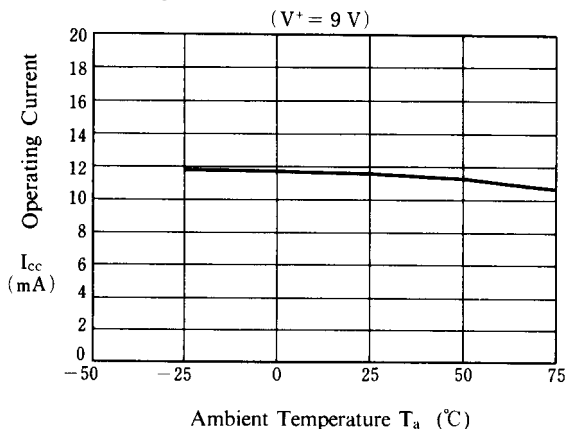

### Voltage Gain vs. Operating Voltage (Ta = 25°C)

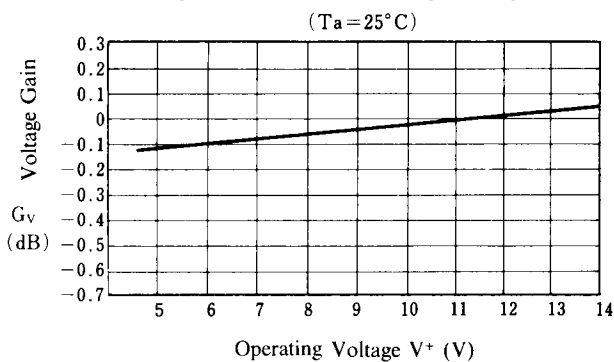

### Voltage Gain vs. Frequency (Ta = 25°C, V<sup>+</sup> = 5V)

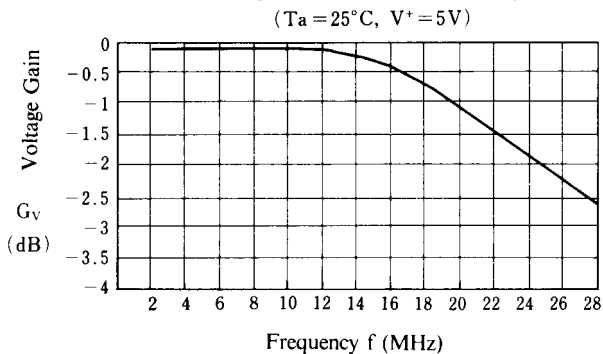

### Voltage Gain vs. Ambient Temperature (V<sup>+</sup> = 5V)

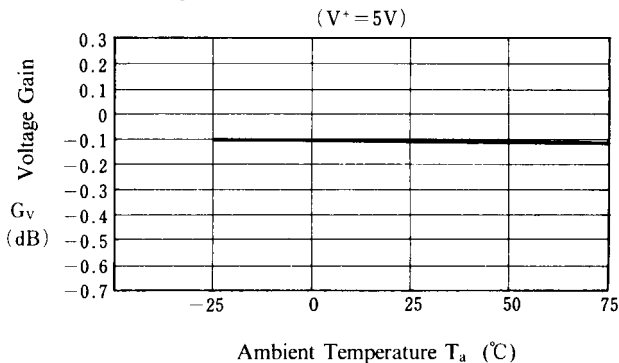

## ■ TYPICAL CHARACTERISTICS (Ta = +25°C)

### Frequency Response vs. Operating Voltage

(Ta = 25°C)

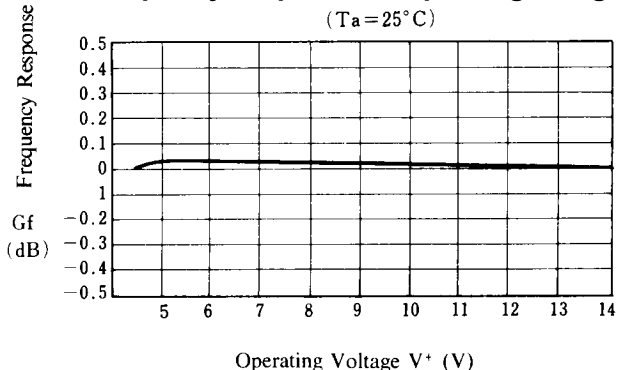

### Frequency Response vs. Ambient Temperature

(V+ = 5V)

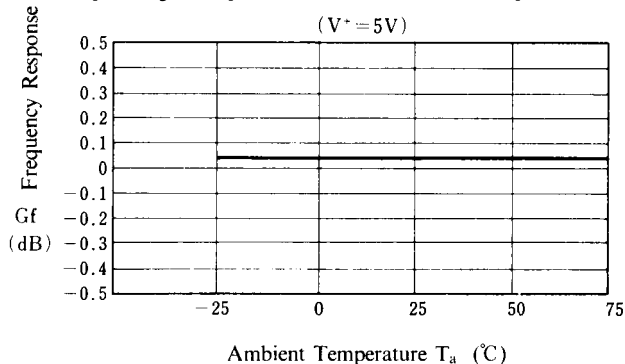

### Offset Voltage vs. Operating Voltage

(Ta = 25°C)

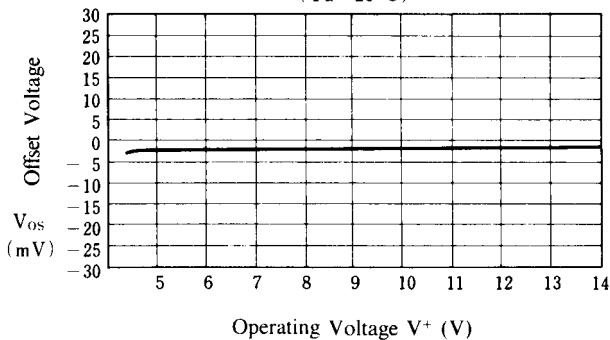

### Offset Voltage vs. Ambient Temperature

(V+ = 5V)

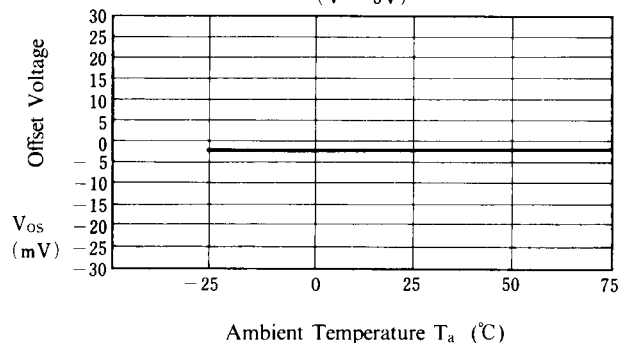

### Switch Change Voltage vs. Operating Voltage

(Ta = 25°C)

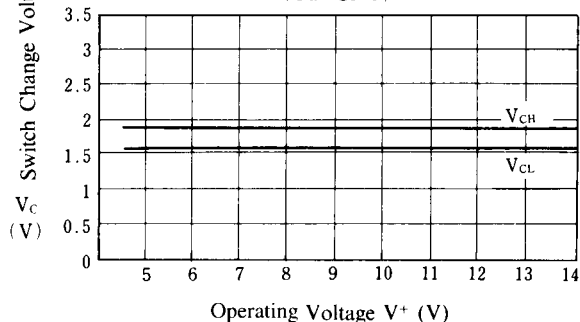

### Switch Change Voltage vs. Ambient Temperature

(V+ = 5V)

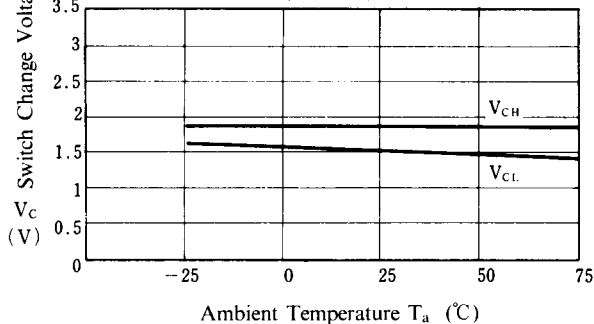

## ■ TYPICAL CHARACTERISTICS (Ta = +25°C)

### Differential Gain vs. Operating Voltage

(Ta = 25°C)

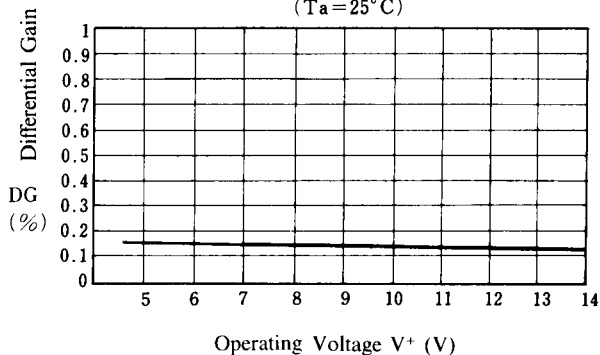

### Differential Phase vs. Operating Voltage

(Ta = 25°C)

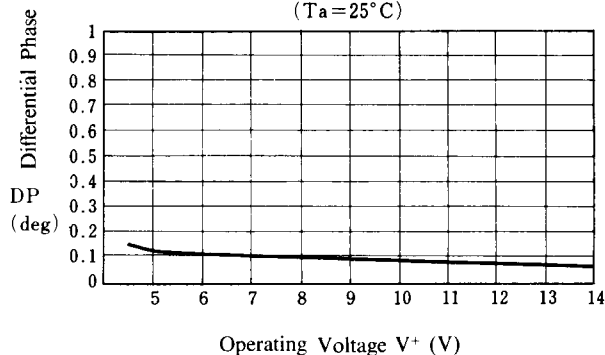

### Differential Gain vs. Ambient Temperature

(V+ = 5V)

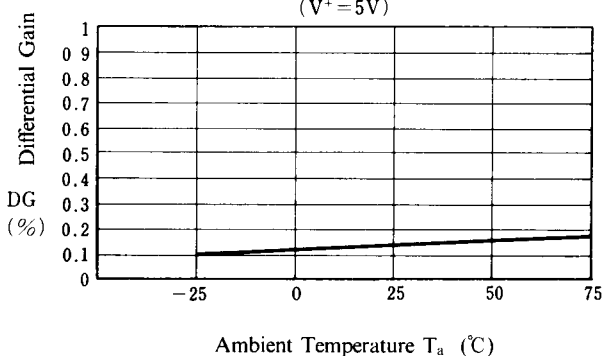

### Differential Phase vs. Ambient Temperature

(V+ = 5V)

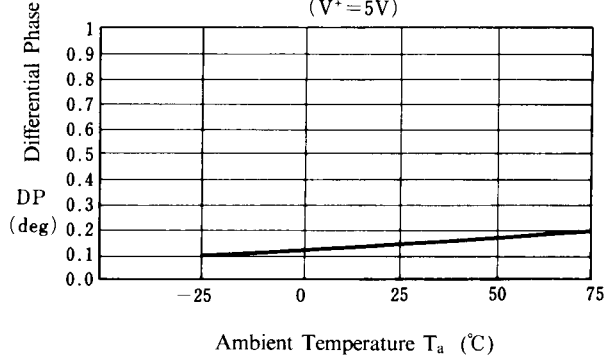

### Differential Gain vs. Load

(Ta = 25°C, V+ = 5V)

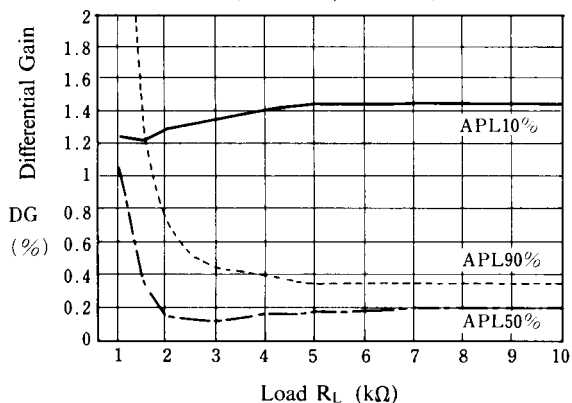

### Differential Phase vs. Load

(Ta = 25°C, V+ = 5V)

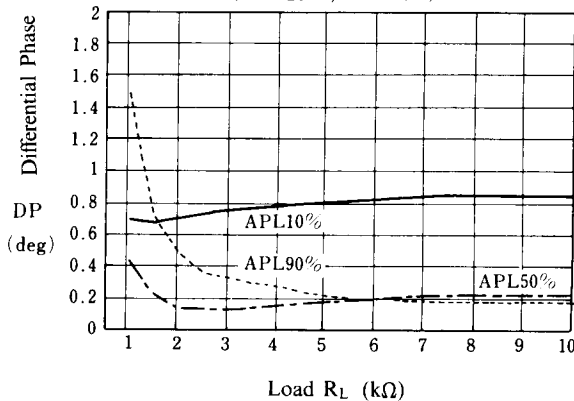

■ TYPICAL CHARACTERISTICS (Ta = +25°C)

**Differential Gain vs. APL**

(Ta = 25°C, V+ = 5V)

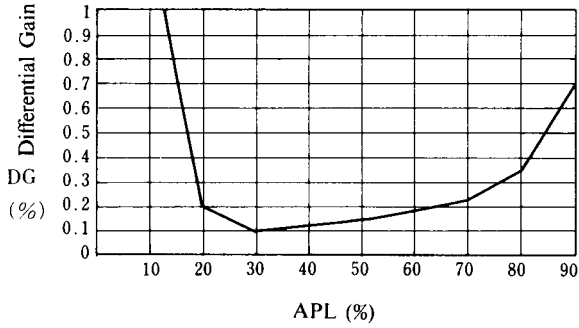

**Differential Phase vs. APL**

(Ta = 25°C, V+ = 5V)

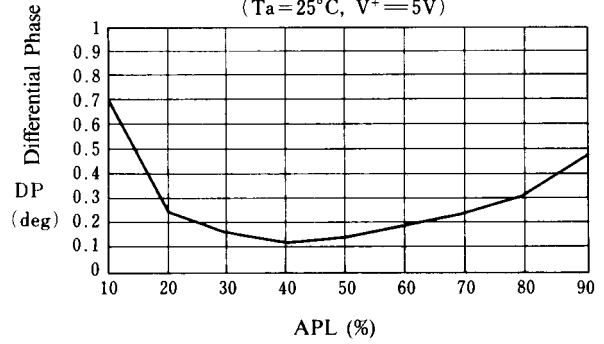

**Differential Gain vs. Load**

(Ta = 25°C, V+ = 5V)

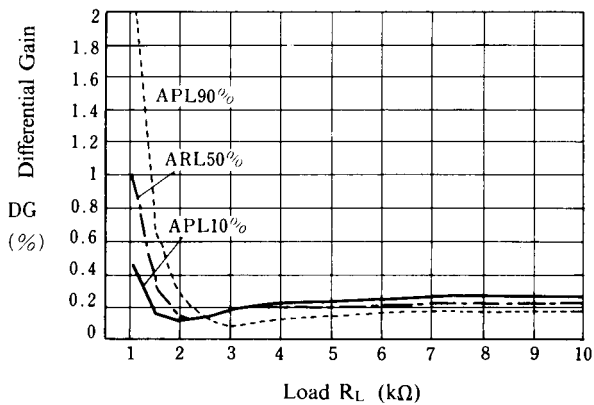

**Differential Phase vs. Load**

(Ta = 25°C, V+ = 5V)

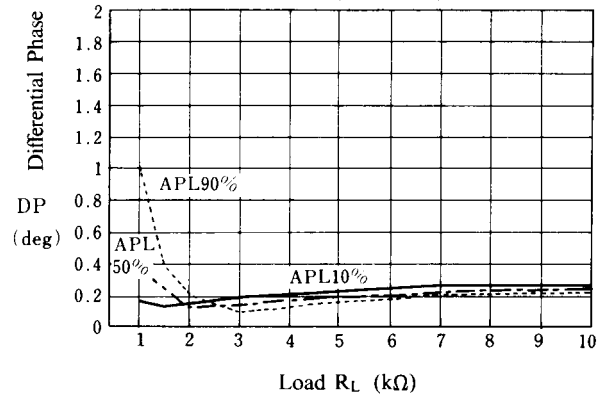

**Differential Gain vs. APL**

(Ta = 25°C, V+ = 5V)

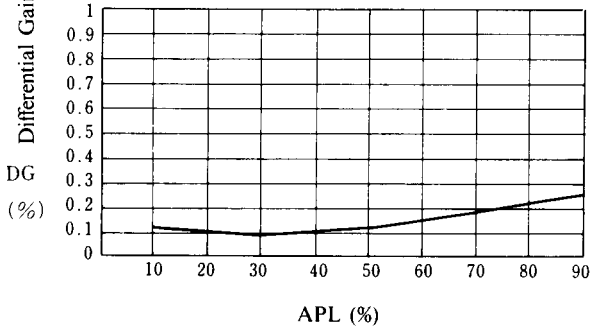

**Differential Phase vs. APL**

(Ta = 25°C, V+ = 5V)

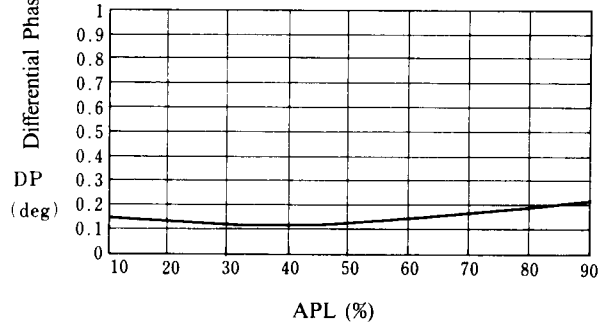

## ■ TYPICAL CHARACTERISTICS (Ta = +25°C)

### Crosstalk vs. Operating Voltage

(Ta = 25°C)

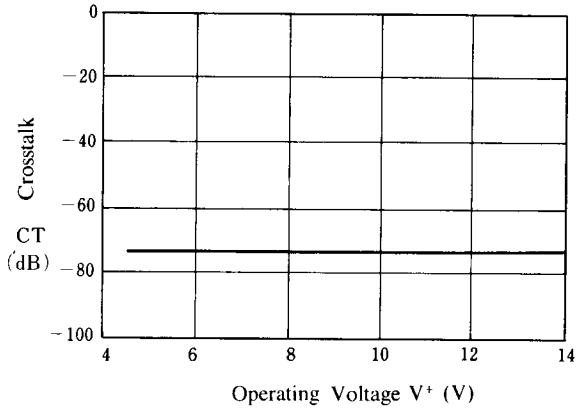

### Crosstalk vs. Temperature

(V+ = 5V)

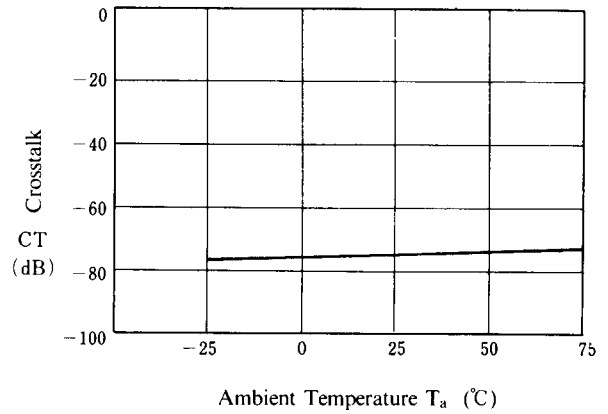

### Crosstalk vs. Operating Voltage

(Ta = 25°C)

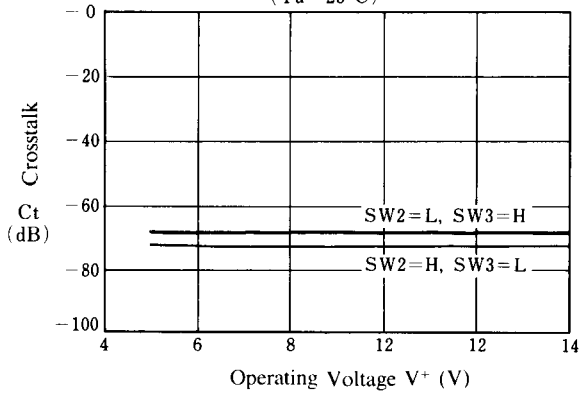

### Crosstalk vs. Ambient Temperature

(V+ = 5V)

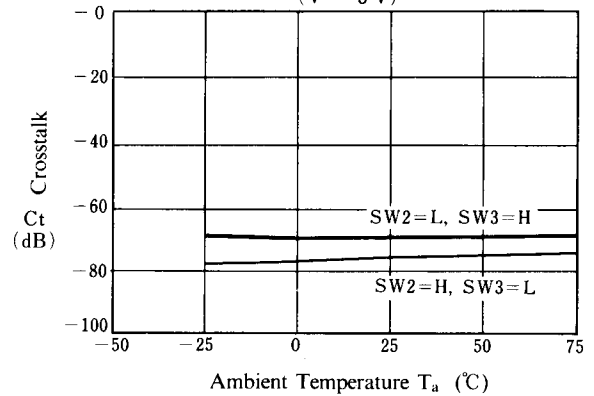

### Crosstalk vs. Operating Voltage

(Ta = 25°C)

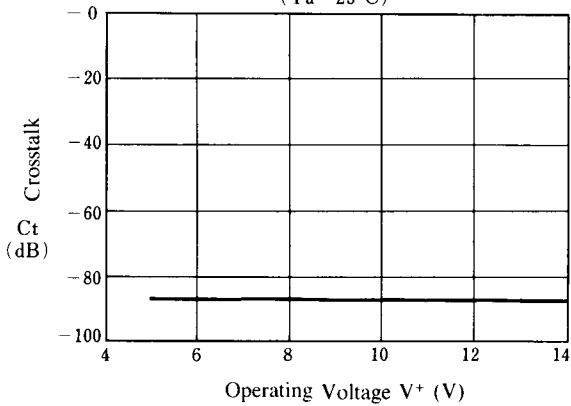

### Crosstalk vs. Ambient Temperature

(V+ = 5V)

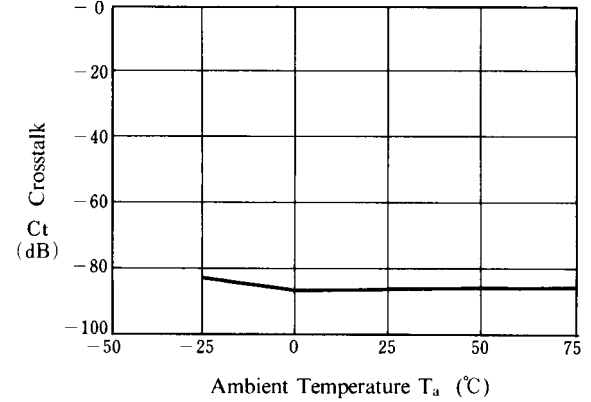



■ TYPICAL CHARACTERISTICS (T<sub>a</sub> = +25°C)

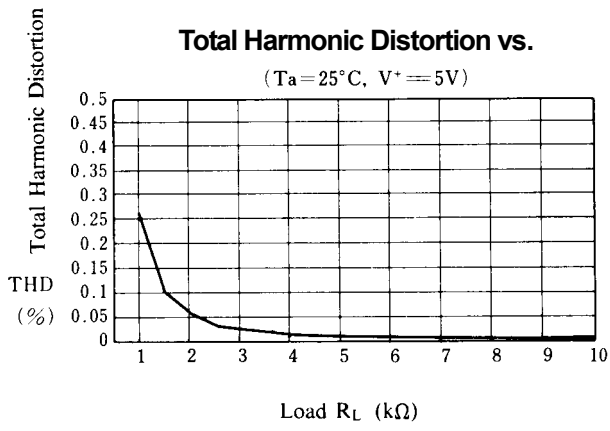

# NJM2508

## ■ APPLICATION

This IC requires  $1\text{M}\Omega$  resistance between INPUT and GND pin for clamp type input since the minute current causes an unstable pin voltage.

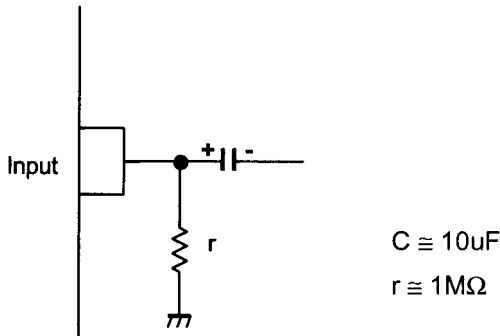

This IC requires  $0.1\mu\text{F}$  capacitor between INPUT and GND,  $1\text{M}\Omega$  resistance between INPUT and GND for clamp type input at mute mode.

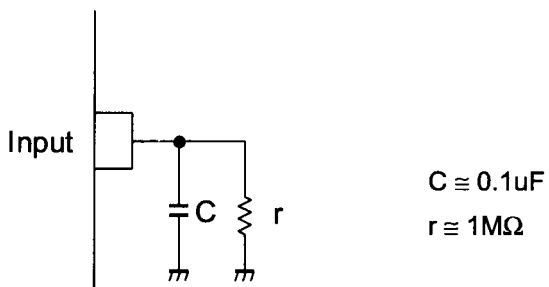

This IC requires  $0.1\mu\text{F}$  capacitor between INPUT and GND for bias type input at mute mode.

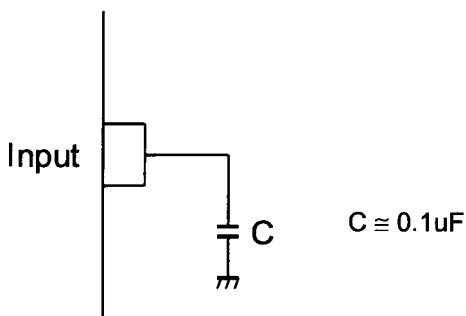

[CAUTION]  
The specifications on this databook are only given for information, without any guarantee as regards either mistakes or omissions. The application circuits in this databook are described only to show representative usages of the product and not intended for the guarantee or permission of any right including the industrial rights.



Компания «ЭлектроПласт» предлагает заключение долгосрочных отношений при поставках импортных электронных компонентов на взаимовыгодных условиях!

Наши преимущества:

- Оперативные поставки широкого спектра электронных компонентов отечественного и импортного производства напрямую от производителей и с крупнейших мировых складов;
- Поставка более 17-ти миллионов наименований электронных компонентов;
- Поставка сложных, дефицитных, либо снятых с производства позиций;
- Оперативные сроки поставки под заказ (от 5 рабочих дней);
- Экспресс доставка в любую точку России;
- Техническая поддержка проекта, помощь в подборе аналогов, поставка прототипов;
- Система менеджмента качества сертифицирована по Международному стандарту ISO 9001;
- Лицензия ФСБ на осуществление работ с использованием сведений, составляющих государственную тайну;
- Поставка специализированных компонентов (Xilinx, Altera, Analog Devices, Intersil, Interpoint, Microsemi, Aeroflex, Peregrine, Syfer, Eurofarad, Texas Instrument, Miteq, Cobham, E2V, MA-COM, Hittite, Mini-Circuits, General Dynamics и др.);

Помимо этого, одним из направлений компании «ЭлектроПласт» является направление «Источники питания». Мы предлагаем Вам помощь Конструкторского отдела:

- Подбор оптимального решения, техническое обоснование при выборе компонента;
- Подбор аналогов;
- Консультации по применению компонента;
- Поставка образцов и прототипов;
- Техническая поддержка проекта;
- Защита от снятия компонента с производства.



#### Как с нами связаться

**Телефон:** 8 (812) 309 58 32 (многоканальный)

**Факс:** 8 (812) 320-02-42

**Электронная почта:** [org@eplast1.ru](mailto:org@eplast1.ru)

**Адрес:** 198099, г. Санкт-Петербург, ул. Калинина, дом 2, корпус 4, литера А.