

KAI-16050

4896 (H) x 3264 (V) Interline CCD Image Sensor

Description

The KAI-16050 Image Sensor is a 16-megapixel CCD in an APS-H optical format. Based on the TRUESENSE 5.5 micron Interline Transfer CCD Platform, the sensor features broad dynamic range, excellent imaging performance, and a flexible readout architecture that enables use of 1, 2, or 4 outputs for full resolution readout up to 8 frames per second. A vertical overflow drain structure suppresses image blooming and enables electronic shuttering for precise exposure control.

The sensor is available with the TRUESENSE Sparse Color Filter Pattern, a technology which provides a 2x improvement in light sensitivity compared to a standard color Bayer part.

The sensor shares common PGA pin-out and electrical configurations with other devices based on the TRUESENSE 5.5 micron Interline Transfer CCD Platform, allowing a single camera design to be leveraged to support multiple members of this sensor family.

Table 1. GENERAL SPECIFICATIONS

Parameter	Typical Value
Architecture	Interline CCD; Progressive Scan
Total Number of Pixels	4964 (H) x 3332 (V)
Number of Effective Pixels	4920 (H) x 3288 (V)
Number of Active Pixels	4896 (H) x 3264 (V)
Pixel Size	5.5 μm (H) x 5.5 μm (V)
Active Image Size	26.93 mm (H) x 17.95 mm (V) 32.36 mm (diag.) APS-H Format
Aspect Ratio	3:2
Number of Outputs	1, 2, or 4
Charge Capacity	20,000 electrons
Output Sensitivity	34 $\mu\text{V}/e^-$
Quantum Efficiency	
Pan (-AXA, -QXA, -PXA)	43%
R, G, B (-FXA, -QXA)	28%, 35%, 38%
R, G, B (-CXA, -PXA)	29%, 35%, 37%
Read Noise (f = 40 MHz)	12 electrons rms
Dark Current	
Photodiode	2 electrons/s
VCCD	140 electrons/s
Dark Current Doubling Temp.	
Photodiode	7°C
VCCD	9°C
Dynamic Range	64 dB
Charge Transfer Efficiency	0.999999
Blooming Suppression	> 300 X
Smear	Estimated -100 dB
Image Lag	< 10 electrons
Maximum Pixel Clock Speed	40 MHz
Maximum Frame Rates	
Quad Output	8 fps
Dual Output	4 fps
Single Output	2 fps
Package	72 pin PGA
Cover Glass	AR coated, 2 Sides

NOTE: All parameters are specified at T = 40°C unless otherwise noted.



ON Semiconductor®

www.onsemi.com



Figure 1. KAI-16050 CCD Image Sensor

Features

- Bayer Color Pattern, TRUESENSE Sparse Color Filter Pattern, and Monochrome Configurations
- Progressive Scan Readout
- Flexible Readout Architecture
- High Frame Rate
- High Sensitivity
- Low Noise Architecture
- Excellent Smear Performance
- Package Pin Reserved for Device Identification

Applications

- Industrial Imaging and Inspection
- Traffic
- Security

ORDERING INFORMATION

See detailed ordering and shipping information on page 2 of this data sheet.

KAI-16050

ORDERING INFORMATION

Table 2. ORDERING INFORMATION

Part Number	Description	Marking Code
KAI-16050-AXA-JD-B1	Monochrome, Special Microlens, PGA Package, Sealed Clear Cover Glass with AR coating (both sides), Grade 1	KAI-16050-AXA Serial Number
KAI-16050-AXA-JD-B2	Monochrome, Special Microlens, PGA Package, Sealed Clear Cover Glass with AR coating (both sides), Grade 2	
KAI-16050-AXA-JD-AE	Monochrome, Special Microlens, PGA Package, Sealed Clear Cover Glass with AR coating (both sides), Engineering Grade	
KAI-16050-FXA-JD-B1	Gen2 Color (Bayer RGB), Special Microlens, PGA Package, Sealed Clear Cover Glass with AR coating (both sides), Grade 1	KAI-16050-FXA Serial Number
KAI-16050-FXA-JD-B2	Gen2 Color (Bayer RGB), Special Microlens, PGA Package, Sealed Clear Cover Glass with AR coating (both sides), Grade 2	
KAI-16050-FXA-JD-AE	Gen2 Color (Bayer RGB), Special Microlens, PGA Package, Sealed Clear Cover Glass with AR coating (both sides), Engineering Grade	
KAI-16050-QXA-JD-B1	Gen2 Color (Sparse CFA), Special Microlens, PGA Package, Sealed Clear Cover Glass with AR coating (both sides), Grade 1	KAI-16050-QXA Serial Number
KAI-16050-QXA-JD-B2	Gen2 Color (Sparse CFA), Special Microlens, PGA Package, Sealed Clear Cover Glass with AR coating (both sides), Grade 2	
KAI-16050-QXA-JD-AE	Gen2 Color (Sparse CFA), Special Microlens, PGA Package, Sealed Clear Cover Glass with AR coating (both sides), Engineering Grade	

Table 3. EVALUATION SUPPORT

Catalog Number	Product Name	Description
4H2207	G2-FPGA-BD-14-40-A-GEVK	FPGA Board for IT-CCD Evaluation Hardware
4H2209	KAI-72PIN-HEAD-BD-A-GEVB	72 Pin Imager Board for IT-CCD Evaluation Hardware
4H2211	LENS-MOUNT-KIT-B-GEVK	Lens Mount Kit for IT-CCD Evaluation Hardware

See the ON Semiconductor *Device Nomenclature* document (TND310/D) for a full description of the naming convention used for image sensors. For reference documentation, including information on evaluation kits, please visit our web site at www.onsemi.com.

KAI-16050

Table 4. NOT RECOMMENDED FOR NEW DESIGNS

Part Number	Description	Marking Code
KAI-16050-CXA-JD-B1	Gen1 Color (Bayer RGB), Special Microlens, PGA Package, Sealed Clear Cover Glass with AR coating (both sides), Grade 1	KAI-16050-CXA Serial Number
KAI-16050-CXA-JD-B2	Gen1 Color (Bayer RGB), Special Microlens, PGA Package, Sealed Clear Cover Glass with AR coating (both sides), Grade 2	
KAI-16050-CXA-JD-AE	Gen1 Color (Bayer RGB), Special Microlens, PGA Package, Sealed Clear Cover Glass with AR coating (both sides), Engineering Grade	
KAI-16050-PXA-JD-B1	Gen1 Color (TRUESENSE Sparse CFA), Special Microlens, PGA Package, Sealed Clear Cover Glass with AR coating (both sides), Grade 1	KAI-16050-PXA Serial Number
KAI-16050-PXA-JD-B2	Gen1 Color (TRUESENSE Sparse CFA), Special Microlens, PGA Package, Sealed Clear Cover Glass with AR coating (both sides), Grade 2	
KAI-16050-PXA-JD-AE	Gen1 Color (TRUESENSE Sparse CFA), Special Microlens, PGA Package, Sealed Clear Cover Glass with AR coating (both sides), Engineering Grade	

DEVICE DESCRIPTION

Architecture

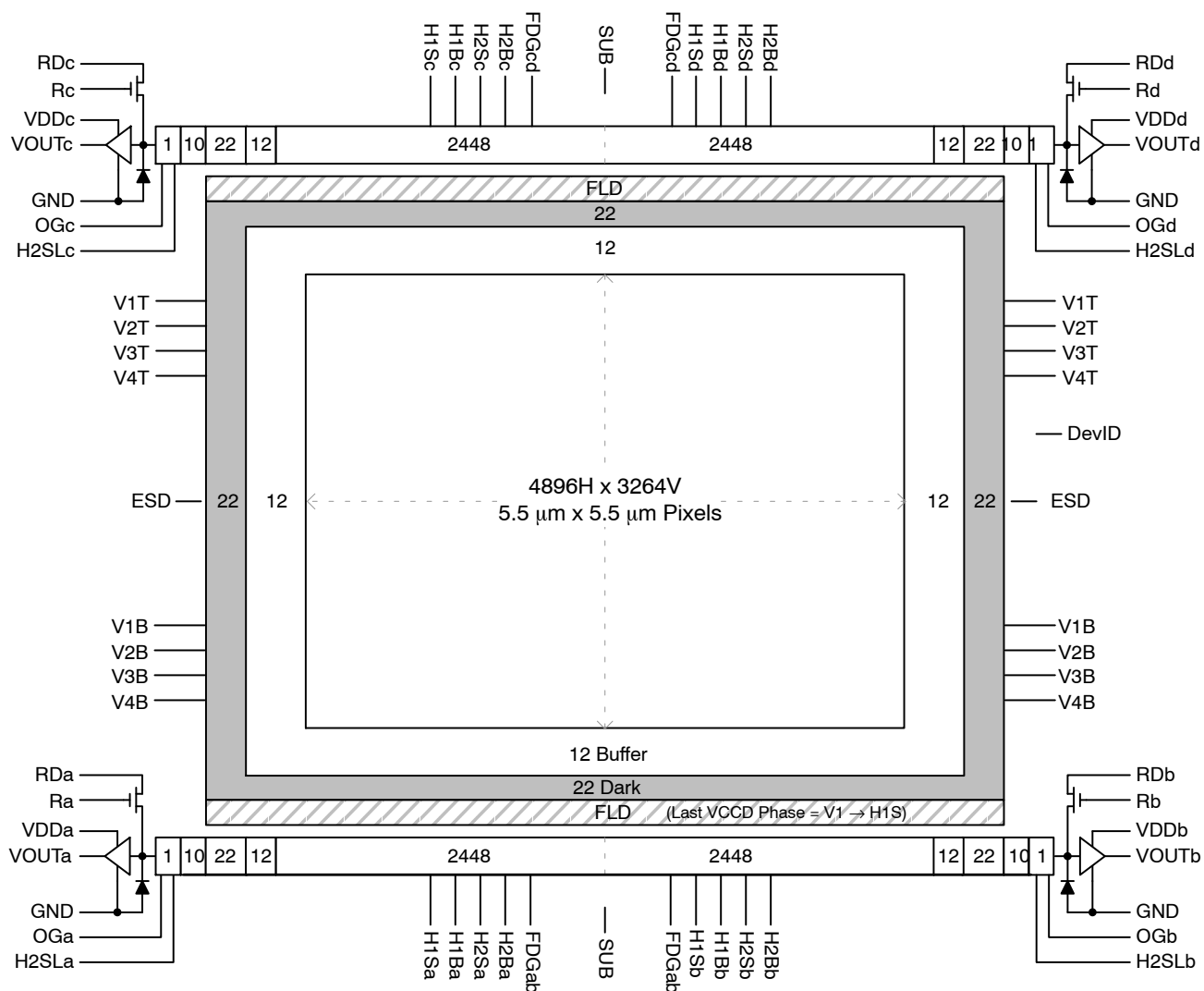

Figure 2. Block Diagram

Dark Reference Pixels

There are 22 dark reference rows at the top and 22 dark rows at the bottom of the image sensor. The dark rows are not entirely dark and so should not be used for a dark reference level. Use the 22 dark columns on the left or right side of the image sensor as a dark reference.

Under normal circumstances use only the center 20 columns of the 22 column dark reference due to potential light leakage.

Dummy Pixels

Within each horizontal shift register there are 11 leading additional shift phases. These pixels are designated as dummy pixels and should not be used to determine a dark reference level.

In addition, there is one dummy row of pixels at the top and bottom of the image.

Active Buffer Pixels

12 unshielded pixels adjacent to any leading or trailing dark reference regions are classified as active buffer pixels. These pixels are light sensitive but are not tested for defects and non-uniformities.

Image Acquisition

An electronic representation of an image is formed when incident photons falling on the sensor plane create electron-hole pairs within the individual silicon photodiodes. These photoelectrons are collected locally by the formation of potential wells at each photosite. Below photodiode saturation, the number of photoelectrons collected at each pixel is linearly dependent upon light level and exposure time and non-linearly dependent on wavelength. When the photodiodes charge capacity is reached, excess electrons are discharged into the substrate to prevent blooming.

ESD Protection

Adherence to the power-up and power-down sequence is critical. Failure to follow the proper power-up and

power-down sequences may cause damage to the sensor. See Power-Up and Power-Down Sequence section.

Bayer Color Filter Pattern

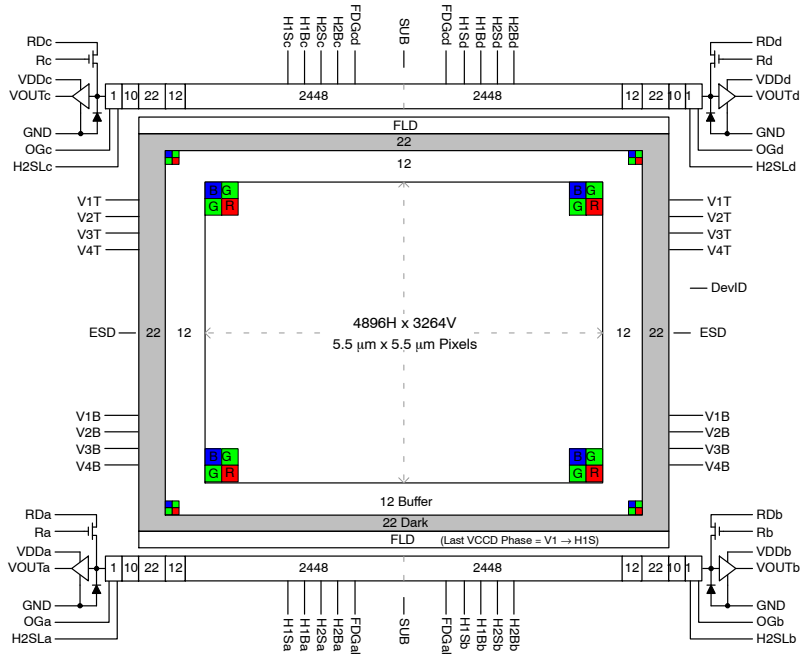

Figure 3. Bayer Color Filter Pattern

TRUESENSE Sparse Color Filter Pattern

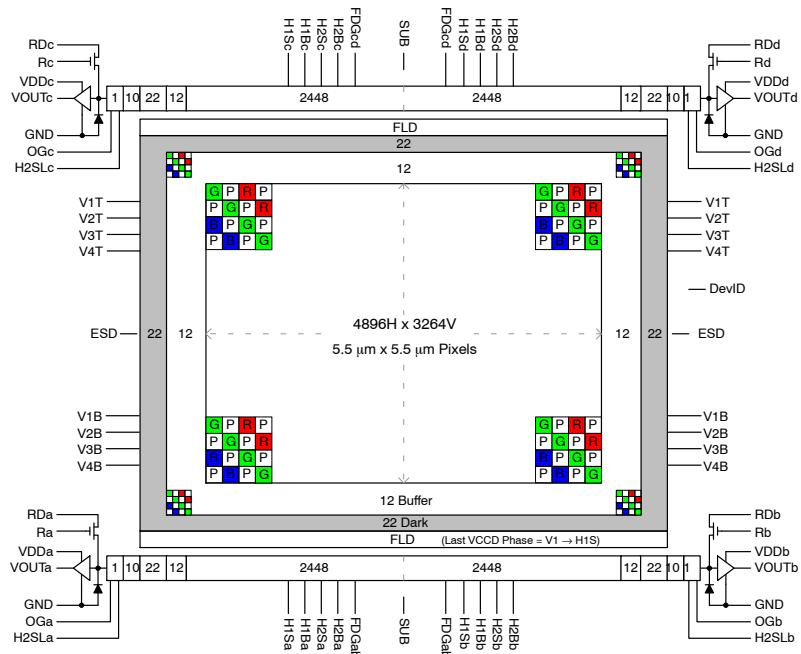

Figure 4. TRUESENSE Sparse Color Filter Pattern

KAI-16050

PHYSICAL DESCRIPTION

Pin Description and Device Orientation

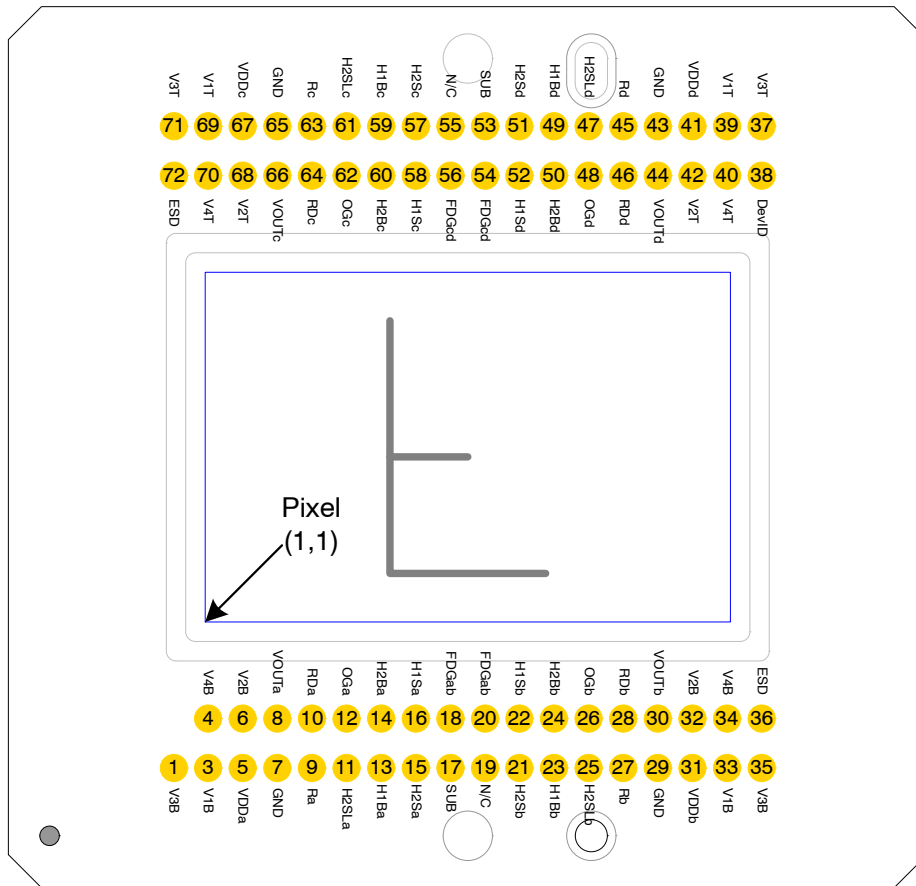

Figure 5. Package Pin Designations – Top View

Table 5. PIN DESCRIPTION

Pin	Name	Description
1	V3B	Vertical CCD Clock, Phase 3, Bottom
3	V1B	Vertical CCD Clock, Phase 1, Bottom
4	V4B	Vertical CCD Clock, Phase 4, Bottom
5	VDDa	Output Amplifier Supply, Quadrant a
6	V2B	Vertical CCD Clock, Phase 2, Bottom
7	GND	Ground
8	VOUTa	Video Output, Quadrant a
9	Ra	Reset Gate, Quadrant a
10	RDa	Reset Drain, Quadrant a
11	H2SLa	Horizontal CCD Clock, Phase 2, Storage, Last Phase, Quadrant a
12	OGa	Output Gate, Quadrant a
13	H1Ba	Horizontal CCD Clock, Phase 1, Barrier, Quadrant a
14	H2Ba	Horizontal CCD Clock, Phase 2, Barrier, Quadrant a
15	H2Sa	Horizontal CCD Clock, Phase 2, Storage, Quadrant a
16	H1Sa	Horizontal CCD Clock, Phase 1, Storage, Quadrant a
17	SUB	Substrate
18	FDGAb	Fast Line Dump Gate, Bottom
19	N/C	No Connect
20	FDGAb	Fast Line Dump Gate, Bottom
21	H2Sb	Horizontal CCD Clock, Phase 2, Storage, Quadrant b
22	H1Sb	Horizontal CCD Clock, Phase 1, Storage, Quadrant b
23	H1Bb	Horizontal CCD Clock, Phase 1, Barrier, Quadrant b
24	H2Bb	Horizontal CCD Clock, Phase 2, Barrier, Quadrant b
25	H2SLb	Horizontal CCD Clock, Phase 2, Storage, Last Phase, Quadrant b
26	OGb	Output Gate, Quadrant b
27	Rb	Reset Gate, Quadrant b
28	RDb	Reset Drain, Quadrant b
29	GND	Ground
30	VOUTb	Video Output, Quadrant b
31	VDDb	Output Amplifier Supply, Quadrant b
32	V2B	Vertical CCD Clock, Phase 2, Bottom
33	V1B	Vertical CCD Clock, Phase 1, Bottom
34	V4B	Vertical CCD Clock, Phase 4, Bottom
35	V3B	Vertical CCD Clock, Phase 3, Bottom
36	ESD	ESD Protection Disable

Pin	Name	Description
72	ESD	ESD Protection Disable
71	V3T	Vertical CCD Clock, Phase 3, Top
70	V4T	Vertical CCD Clock, Phase 4, Top
69	V1T	Vertical CCD Clock, Phase 1, Top
68	V2T	Vertical CCD Clock, Phase 2, Top
67	VDDc	Output Amplifier Supply, Quadrant c
66	VOUTc	Video Output, Quadrant c
65	GND	Ground
64	RDc	Reset Drain, Quadrant c
63	Rc	Reset Gate, Quadrant c
62	OGc	Output Gate, Quadrant c
61	H2SLc	Horizontal CCD Clock, Phase 2, Storage, Last Phase, Quadrant c
60	H2Bc	Horizontal CCD Clock, Phase 2, Barrier, Quadrant c
59	H1Bc	Horizontal CCD Clock, Phase 1, Barrier, Quadrant c
58	H1Sc	Horizontal CCD Clock, Phase 1, Storage, Quadrant c
57	H2Sc	Horizontal CCD Clock, Phase 2, Storage, Quadrant c
56	FDGcd	Fast Line Dump Gate, Top
55	N/C	No Connect
54	FDGcd	Fast Line Dump Gate, Top
53	SUB	Substrate
52	H1Sd	Horizontal CCD Clock, Phase 1, Storage, Quadrant d
51	H2Sd	Horizontal CCD Clock, Phase 2, Storage, Quadrant d
50	H2Bd	Horizontal CCD Clock, Phase 2, Barrier, Quadrant d
49	H1Bd	Horizontal CCD Clock, Phase 1, Barrier, Quadrant d
48	OGd	Output Gate, Quadrant d
47	H2SLd	Horizontal CCD Clock, Phase 2, Storage, Last Phase, Quadrant d
46	RDd	Reset Drain, Quadrant d
45	Rd	Reset Gate, Quadrant d
44	VOUTd	Video Output, Quadrant d
43	GND	Ground
42	V2T	Vertical CCD Clock, Phase 2, Top
41	VDDd	Output Amplifier Supply, Quadrant d
40	V4T	Vertical CCD Clock, Phase 4, Top
39	V1T	Vertical CCD Clock, Phase 1, Top
38	DevID	Device Identification
37	V3T	Vertical CCD Clock, Phase 3, Top

1. Liked named pins are internally connected and should have a common drive signal.
2. N/C pins (19, 55) should be left floating.

IMAGING PERFORMANCE

Table 6. TYPICAL OPERATION CONDITIONS

Unless otherwise noted, the Imaging Performance Specifications are measured using the following conditions.

Description	Condition	Notes
Light Source	Continuous red, green and blue LED illumination	For monochrome sensor, only green LED used.
Operation	Nominal operating voltages and timing	

**Table 7. SPECIFICATIONS
All Configurations**

Description	Symbol	Min.	Nom.	Max.	Units	Sampling Plan	Temperature Tested At (°C)	Notes
Dark Field Global Non-Uniformity	DSNU	–	–	5	mVpp	Die	27, 40	
Bright Field Global Non-Uniformity		–	2	5	%rms	Die	27, 40	1
Bright Field Global Peak to Peak Non-Uniformity	PRNU	–	10	30	%pp	Die	27, 40	1
Bright Field Center Non-Uniformity		–	1	2	%rms	Die	27, 40	1
Maximum Photoresponse Nonlinearity	NL	–	2	–	%	Design		2
Maximum Gain Difference Between Outputs	ΔG	–	10	–	%	Design		2
Maximum Signal Error due to Nonlinearity Differences	ΔNL	–	1	–	%	Design		2
Horizontal CCD Charge Capacity	HNe	–	50	–	ke ⁻	Design		
Vertical CCD Charge Capacity	VNe	–	45	–	ke ⁻	Design		
Photodiode Charge Capacity	PNe	–	20	–	ke ⁻	Die	27, 40	3
Horizontal CCD Charge Transfer Efficiency	HCTE	0.999995	0.999999	–		Die		
Vertical CCD Charge Transfer Efficiency	VCTE	0.999995	0.999999	–		Die		
Photodiode Dark Current	l _{pd}	–	7	70	e/p/s	Die	40	
Vertical CCD Dark Current	l _{vd}	–	140	400	e/p/s	Die	40	
Image Lag	Lag	–	–	10	e ⁻	Design		
Antiblooming Factor	X _{ab}	300	–	–		Design		
Vertical Smear	S _{mr}	–	-100	–	dB	Design		
Read Noise	n _{e-T}	–	12	–	e ⁻ rms	Design		4
Dynamic Range	DR	–	64	–	dB	Design		4, 5
Output Amplifier DC Offset	V _{odc}	–	9.4	–	V	Die	27, 40	
Output Amplifier Bandwidth	f _{-3db}	–	250	–	MHz	Die		6
Output Amplifier Impedance	R _{OUT}	–	127	–	Ω	Die	27, 40	
Output Amplifier Sensitivity	$\Delta V/\Delta N$	–	34	–	μV/e ⁻	Design		

1. Per color
2. Value is over the range of 10% to 90% of photodiode saturation.
3. The operating value of the substrate voltage, VAB, will be marked on the shipping container for each device. The value of VAB is set such that the photodiode charge capacity is 680 mV.
4. At 40 MHz
5. Uses 20LOG (PNe/ n_{e-T})
6. Assumes 5 pF load.

KAI-16050

Table 8. KAI-16050-AXA, KAI-16050-QXA, AND KAI-16050-PXA¹ CONFIGURATIONS

Description	Symbol	Min.	Nom.	Max.	Units	Sampling Plan	Temperature Tested At (°C)	Notes
Peak Quantum Efficiency	QE _{max}	–	43	–	%	Design		
Peak Quantum Efficiency Wavelength	λQE	–	470	–	nm	Design		

1. This color filter set configuration (Gen1) is not recommended for new designs.

Table 9. KAI-16050-FBA AND KAI-16050-QBA GEN2 COLOR CONFIGURATIONS WITH MAR GLASS

Description	Symbol	Min.	Nom.	Max.	Units	Sampling Plan	Temperature Tested At (°C)	Notes
Peak Quantum Efficiency	QE _{max}	–	37	–	%	Design		
Blue		35						
Green		29						
Red								
Peak Quantum Efficiency Wavelength	λQE	–	460	–	nm	Design		
			530					
			605					

Table 10. KAI-16050-CBA AND KAI-16050-PBA GEN1 COLOR CONFIGURATIONS WITH MAR GLASS

Description	Symbol	Min.	Nom.	Max.	Units	Sampling Plan	Temperature Tested At (°C)	Notes
Peak Quantum Efficiency	QE _{max}	–	38	–	%	Design		1
Blue		35						
Green		28						
Red								
Peak Quantum Efficiency Wavelength	λQE	–	470	–	nm	Design		1
			540					
			620					

1. This color filter set configuration (Gen1) is not recommended for new designs.

TYPICAL PERFORMANCE CURVES

Quantum Efficiency

Monochrome with Microlens

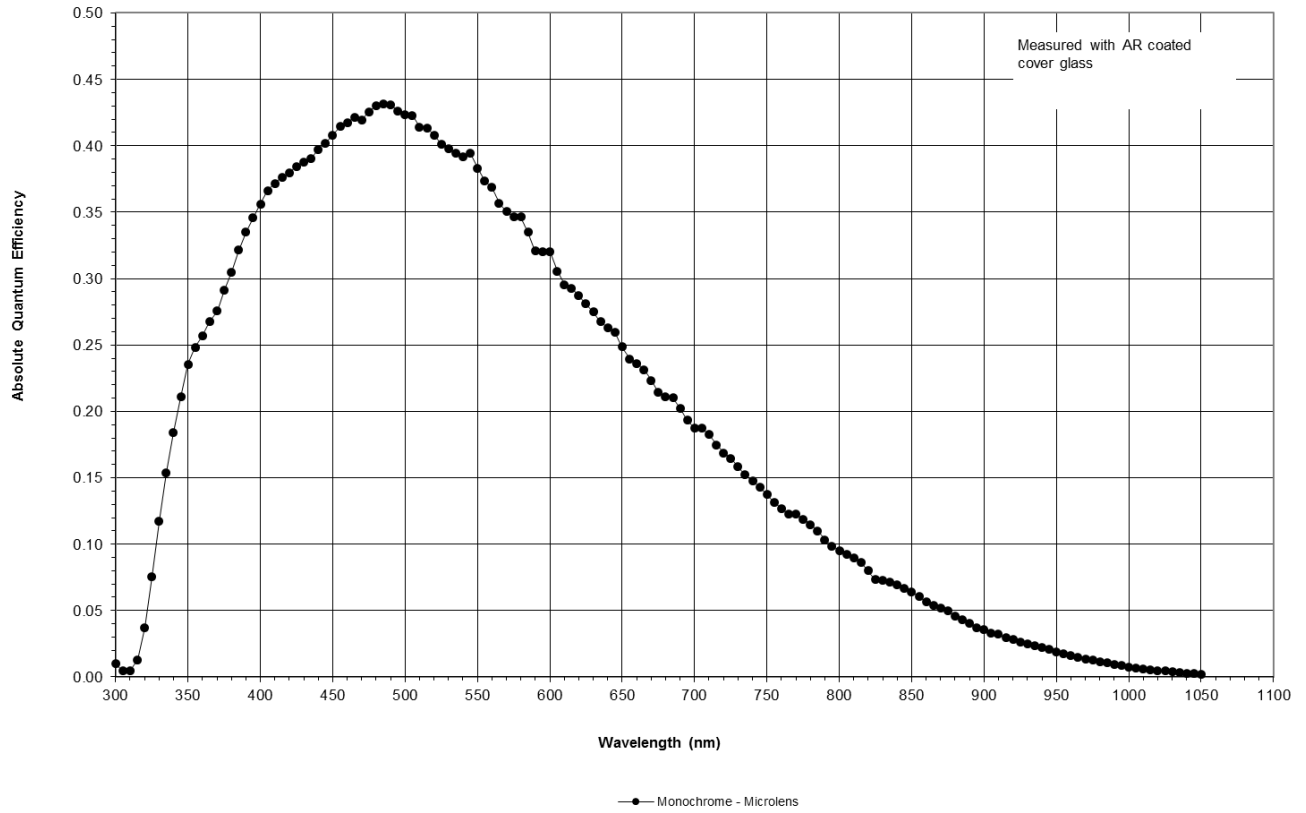

Figure 6. Monochrome with Microlens Quantum Efficiency

KAI-16050

Color (Bayer RGB) with Microlens and MAR Cover Glass (Gen2 and Gen1 CFA)



Figure 7. Color (Bayer) with Microlens Quantum Efficiency

Color (TRUESENSE Sparse CFA) with Microlens (Gen2 and Gen1 CFA)



Figure 8. Color (TRUESENSE Sparse CFA) with Microlens Quantum Efficiency

Angular Quantum Efficiency

For the curves marked “Horizontal”, the incident light angle is varied in a plane parallel to the HCCD.

For the curves marked “Vertical”, the incident light angle is varied in a plane parallel to the VCCD.

Monochrome with Microlens

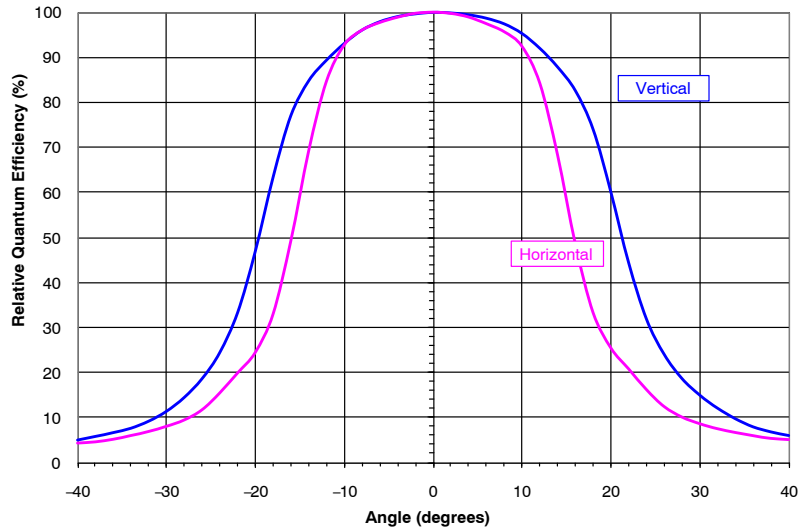

Figure 9. Monochrome with Microlens Angular Quantum Efficiency

Dark Current versus Temperature

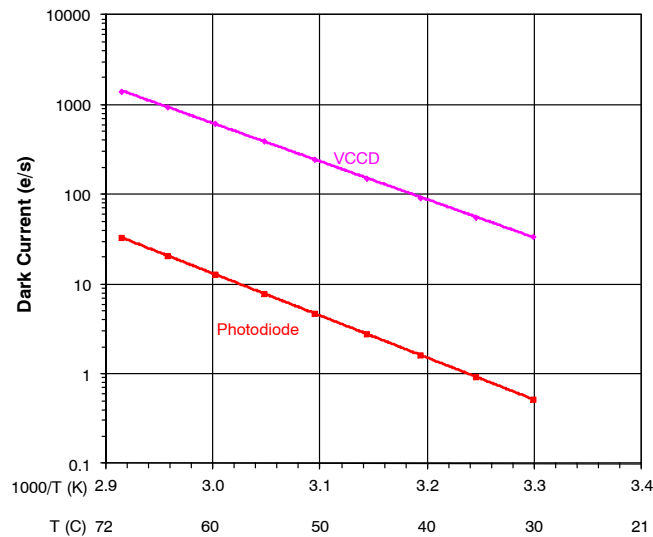

Figure 10. Dark Current versus Temperature

KAI-16050

Power – Estimated

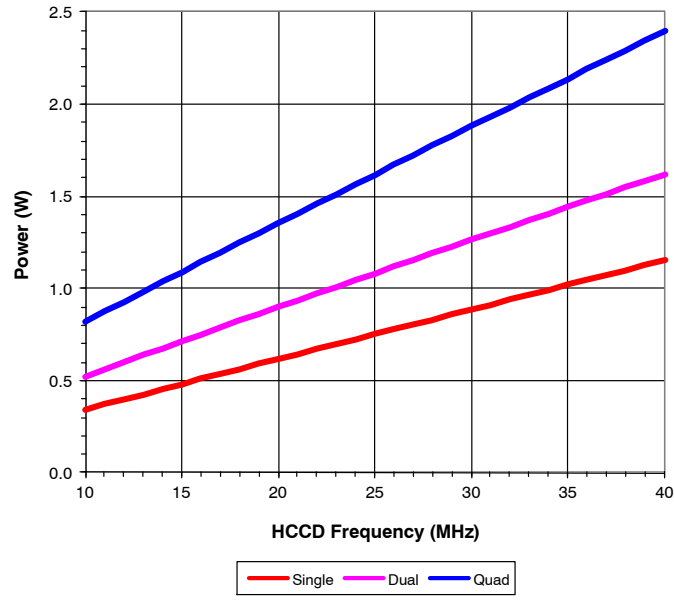

Figure 11. Power

Frame Rates

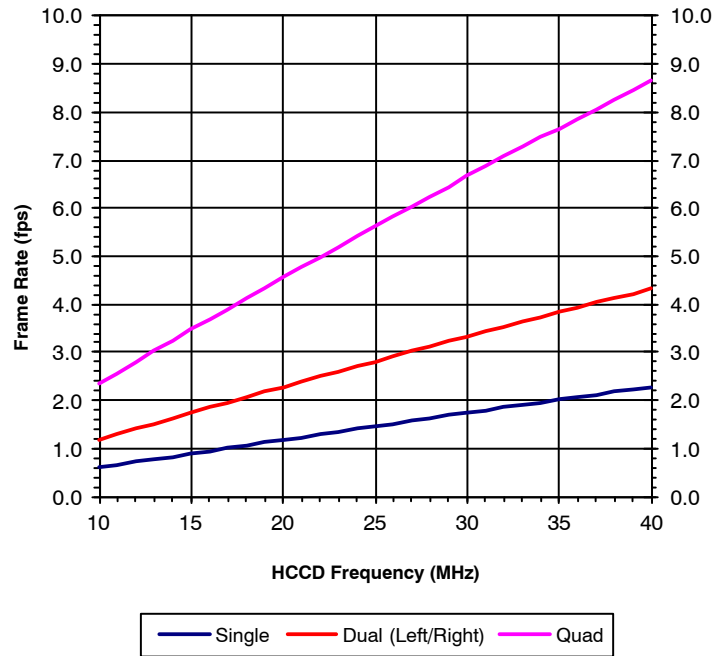

Figure 12. Frame Rates

DEFECT DEFINITIONS

Table 11. OPERATION CONDITIONS FOR DEFECT TESTING AT 40°C

Description	Condition	Notes
Operational Mode	Two outputs, using VOUTa and VOUTc, continuous readout	
HCCD Clock Frequency	10 MHz	
Pixels Per Line	5120	1
Lines Per Frame	1760	2
Line Time	547.7 μsec	
Frame Time	964.0 msec	
Photodiode Integration Time (PD_Tint)	Mode A: PD_Tint = Frame Time = 964.0 msec, no electronic shutter used	
VCCD Integration Time	912.5 msec	3
Temperature	40°C	
Light Source	Continuous red, green and blue LED illumination	4
Operation	Nominal operating voltages and timing	

1. Horizontal overclocking used.
2. Vertical overclocking used.
3. VCCD Integration Time = 1666 lines x Line Time, which is the total time a pixel will spend in the VCCD registers.
4. For monochrome sensor, only the green LED is used.

Table 12. DEFECT DEFINITIONS FOR TESTING AT 40°C

Description	Definition	Grade 1	Grade 2 Mono	Grade 2 Color	Notes
Major dark field defective bright pixel	PD_Tint = Mode A → Defect ≥ 328 mV	150	300	300	1
Major bright field defective dark pixel	Defect ≥ 12%				
Minor dark field defective bright pixel	PD_Tint = Mode A → Defect ≥ 164 mV	1500	3000	3000	
Cluster defect	A group of 2 to 19 contiguous major defective pixels, but no more than 3 adjacent defects horizontally.	20	n/a	n/a	2
Cluster defect	A group of 2 to 38 contiguous major defective pixels, but no more than 5 adjacent defects horizontally.	n/a	30	30	
Column defect	A group of more than 10 contiguous major defective pixels along a single column	0	4	15	2

1. For the color devices (KAI-16050-CXA and KAI-16050-PXA), a bright field defective pixel deviates by 12% with respect to pixels of the same color.
2. Column and cluster defects are separated by no less than two (2) good pixels in any direction (excluding single pixel defects).

KAI-16050

Table 13. OPERATION CONDITIONS FOR DEFECT TESTING AT 27°C

Description	Condition	Notes
Operational Mode	Two outputs, using VOUTa and VOUTc, continuous readout	
HCCD Clock Frequency	10 MHz	
Pixels Per Line	5120	1
Lines Per Frame	3424	2
Line Time	547.7 μ sec	
Frame Time	1875.4 msec	
Photodiode Integration Time (PD_Tint)	Mode A: PD_Tint = Frame Time = 1875.4 msec, no electronic shutter used	
VCCD Integration Time	912.5 msec	3
Temperature	27°C	
Light Source	Continuous red, green and blue LED illumination	4
Operation	Nominal operating voltages and timing	

1. Horizontal overclocking used.
2. Vertical overclocking used.
3. VCCD Integration Time = 1666 lines x Line Time, which is the total time a pixel will spend in the VCCD registers.
4. For monochrome sensor, only the green LED is used.

Table 14. DEFECT DEFINITIONS FOR TESTING AT 27°C

Description	Definition	Grade 1	Grade 2 Mono	Grade 2 Color	Notes
Major dark field defective bright pixel	PD_Tint = Mode A \rightarrow Defect \geq 200 mV	150	300	300	1
Major bright field defective dark pixel	Defect \geq 12%				
Cluster defect	A group of 2 to 19 contiguous major defective pixels, but no more than 3 adjacent defects horizontally.	20	n/a	n/a	2
Cluster defect	A group of 2 to 38 contiguous major defective pixels, but no more than 5 adjacent defects horizontally.	n/a	30	30	
Column defect	A group of more than 10 contiguous major defective pixels along a single column	0	4	15	2

1. For the color devices (KAI-16050-CXA and KAI-16050-PXA), a bright field defective pixel deviates by 12% with respect to pixels of the same color.
2. Column and cluster defects are separated by no less than two (2) good pixels in any direction (excluding single pixel defects).

Defect Map

The defect map supplied with each sensor is based upon testing at an ambient (27°C) temperature. Minor point

defects are not included in the defect map. All defective pixels are reference to pixel 1, 1 in the defect maps. See Figure 13: Regions of interest for the location of pixel 1,1.

TEST DEFINITIONS

Test Regions of Interest

Image Area ROI: Pixel (1, 1) to Pixel (4920, 3288)
 Active Area ROI: Pixel (13, 13) to Pixel (4908, 3276)
 Center ROI: Pixel (2411, 1595) to Pixel (2510, 1694)
 Only the Active Area ROI pixels are used for performance and defect tests.

Overclocking

The test system timing is configured such that the sensor is overclocked in both the vertical and horizontal directions.

See Figure 13 for a pictorial representation of the regions of interest.

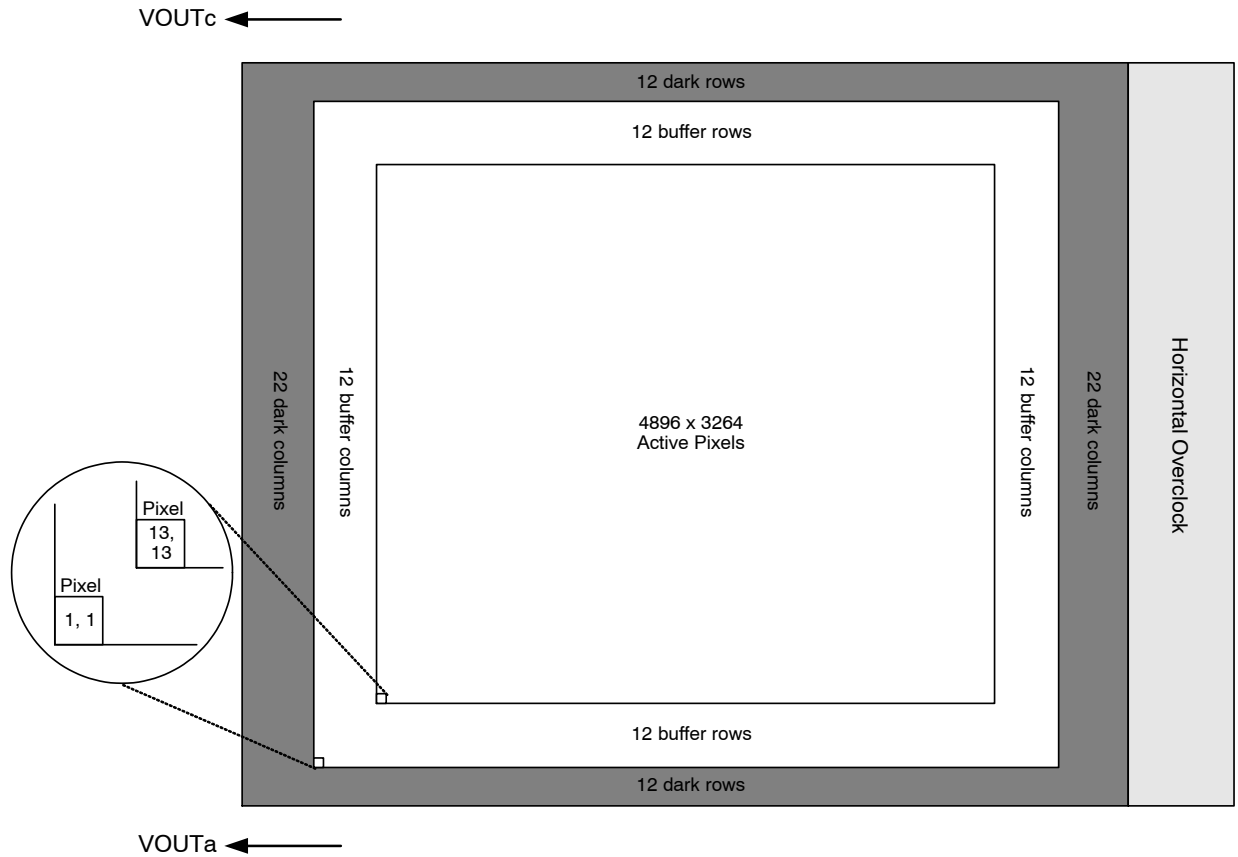

Figure 13. Regions of Interest

Tests

Dark Field Global Non-Uniformity

This test is performed under dark field conditions. The sensor is partitioned into 864 sub regions of interest, each of which is 136 by 136 pixels in size. The average signal level of each of the 864 sub regions of interest is calculated. The signal level of each of the sub regions of interest is calculated using the following formula:

Signal of ROI[i] = (ROI Average in counts – Horizontal overlock average in counts) * mV per count

Where i = 1 to 864. During this calculation on the 864 sub regions of interest, the maximum and minimum signal levels

$$\text{GlobalNon-Uniformity} = 100 \times \left(\frac{\text{ActiveAreaStandardDeviation}}{\text{ActiveAreaSignal}} \right)$$

Units: %rms.

Active Area Signal = Active Area Average – Dark Column Average

Global Peak to Peak Non-Uniformity

This test is performed with the imager illuminated to a level such that the output is at 70% of saturation (approximately 476 mV). Prior to this test being performed the substrate voltage has been set such that the charge capacity of the sensor is 680 mV. The sensor is partitioned into 864 sub regions of interest, each of which is 136 by 136

$$\text{GlobalUniformity} = 100 \times \frac{\text{MaximumSignal} - \text{MinimumSignal}}{\text{ActiveAreaSignal}}$$

Units: %pp

Center Non-Uniformity

This test is performed with the imager illuminated to a level such that the output is at 70% of saturation (approximately 476 mV). Prior to this test being performed

$$\text{Center ROI Uniformity} = 100 \times \left(\frac{\text{Center ROI Standard Deviation}}{\text{Center ROI Signal}} \right)$$

Units: %rms.

Center ROI Signal = Center ROI Average – Dark Column Average

Dark Field Defect Test

This test is performed under dark field conditions. The sensor is partitioned into 864 sub regions of interest, each of which is 136 by 136 pixels in size. In each region of interest, the median value of all pixels is found. For each region of interest, a pixel is marked defective if it is greater than or equal to the median value of that region of interest plus the defect threshold specified in the “Defect Definitions” section.

Bright Field Defect Test

This test is performed with the imager illuminated to a level such that the output is at approximately 476 mV. Prior

are found. The dark field global uniformity is then calculated as the maximum signal found minus the minimum signal level found.

Units: mVpp (millivolts peak to peak)

Global Non-Uniformity

This test is performed with the imager illuminated to a level such that the output is at 70% of saturation (approximately 476 mV). Prior to this test being performed the substrate voltage has been set such that the charge capacity of the sensor is 680 mV. Global non-uniformity is defined as

pixels in size. The average signal level of each of the 864 sub regions of interest (ROI) is calculated. The signal level of each of the sub regions of interest is calculated using the following formula:

Signal of ROI[i] = (ROI Average in counts – Horizontal overlock average in counts) * mV per count

Where i = 1 to 864. During this calculation on the 864 sub regions of interest, the maximum and minimum signal levels are found. The global peak to peak uniformity is then calculated as:

the substrate voltage has been set such that the charge capacity of the sensor is 680 mV. Defects are excluded for the calculation of this test. This test is performed on the center 100 by 100 pixels of the sensor. Center uniformity is defined as:

to this test being performed the substrate voltage has been set such that the charge capacity of the sensor is 680 mV. The average signal level of all active pixels is found. The bright and dark thresholds are set as:

Dark defect threshold = Active Area Signal * threshold
Bright defect threshold = Active Area Signal * threshold

The sensor is then partitioned into 864 sub regions of interest, each of which is 136 by 136 pixels in size. In each region of interest, the average value of all pixels is found. For each region of interest, a pixel is marked defective if it is greater than or equal to the median value of that region of interest plus the bright threshold specified or if it is less than or equal to the median value of that region of interest minus the dark threshold specified.

Example for major bright field defective pixels:

- Average value of all active pixels is found to be 476 mV
- Dark defect threshold: $476 \text{ mV} * 12 \% = 57 \text{ mV}$
- Region of interest #1 selected. This region of interest is pixels 13, 13 to pixels 148, 148.
 - ◆ Median of this region of interest is found to be 470 mV.
 - ◆ Any pixel in this region of interest that is $\leq (470 - 57 \text{ mV})$ 413 mV in intensity will be marked defective.
- All remaining 836 sub regions of interest are analyzed for defective pixels in the same manner.

OPERATION

Table 15. ABSOLUTE MAXIMUM RATINGS

Description	Symbol	Minimum	Maximum	Units	Notes
Operating Temperature	T_{OP}	-50	+70	°C	1
Humidity	RH	+5	+90	%	2
Output Bias Current	I_{out}		60	mA	3
Off-chip Load	C_L		10	pF	

Stresses exceeding those listed in the Maximum Ratings table may damage the device. If any of these limits are exceeded, device functionality should not be assumed, damage may occur and reliability may be affected.

- Noise performance will degrade at higher temperatures.
- $T = 25^{\circ}\text{C}$. Excessive humidity will degrade MTTF.
- Total for all outputs. Maximum current is -15 mA for each output. Avoid shorting output pins to ground or any low impedance source during operation. Amplifier bandwidth increases at higher current and lower load capacitance at the expense of reduced gain (sensitivity).

Table 16. ABSOLUTE MAXIMUM VOLTAGE RATINGS BETWEEN PINS AND GROUND

Description	Minimum	Maximum	Units	Notes
VDD_{α} , $VOUT_{\alpha}$	-0.4	17.5	V	1
RD_{α}	-0.4	15.5	V	1
V1B, V1T	ESD - 0.4	ESD + 24.0	V	
V2B, V2T, V3B, V3T, V4B, V4T	ESD - 0.4	ESD + 14.0	V	
FDG_{ab} , FDG_{cd}	ESD - 0.4	ESD + 15.0	V	
$H1S_{\alpha}$, $H1B_{\alpha}$, $H2S_{\alpha}$, $H2B_{\alpha}$, $H2SL_{\alpha}$, R_{α} , OG_{α}	ESD - 0.4	ESD + 14.0	V	1
ESD	-10.0	0.0	V	
SUB	-0.4	40.0	V	2

- α denotes a, b, c or d
- Refer to Application Note *Using Interline CCD Image Sensors in High Intensity Visible Lighting Conditions*.

Power-Up and Power-Down Sequence

Adherence to the power-up and power-down sequence is critical. Failure to follow the proper power-up and power-down sequences may cause damage to the sensor.

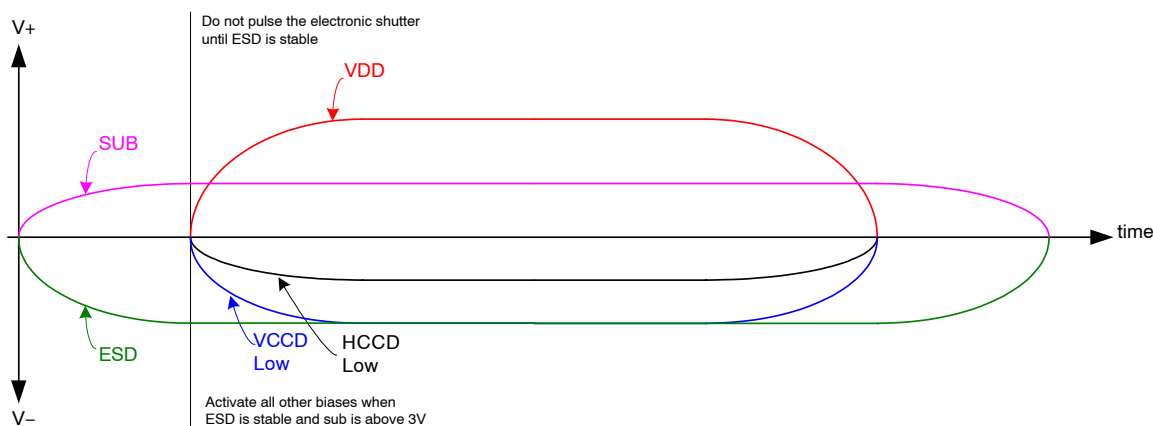

Figure 14. Power-Up and Power-Down Sequence

Notes:

- Activate all other biases when ESD is stable and SUB is above 3 V
- Do not pulse the electronic shutter until ESD is stable
- VDD cannot be +15 V when SUB is 0 V

- The image sensor can be protected from an accidental improper ESD voltage by current limiting the SUB current to less than 10 mA. SUB and VDD must always be greater than GND. ESD must always be less than GND. Placing diodes between SUB, VDD, ESD and ground will protect

the sensor from accidental overshoots of SUB, VDD and ESD during power on and power off. See the figure below.

The VCCD clock waveform must not have a negative overshoot more than 0.4 V below the ESD voltage.



Figure 15.

Example of external diode protection for SUB, VDD and ESD. α denotes a, b, c or d

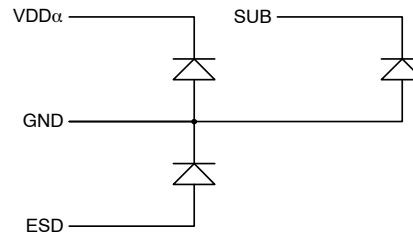

Figure 16.

Table 17. DC BIAS OPERATING CONDITIONS

Description	Pins	Symbol	Minimum	Nominal	Maximum	Units	Maximum DC Current	Notes
Reset Drain	RD α	RD	+11.8	+12.0	+12.2	V	10 μ A	1
Output Gate	OG α	OG	-2.2	-2.0	-1.8	V	10 μ A	1
Output Amplifier Supply	VDD α	VDD	+14.5	+15.0	+15.5	V	11.0 mA	1,2
Ground	GND	GND	0.0	0.0	0.0	V	-1.0 mA	
Substrate	SUB	VSUB	+5.0	VAB	VDD	V	50 μ A	3, 8
ESD Protection Disable	ESD	ESD	-9.5	-9.0	V _{x_L}	V	50 μ A	6, 7, 9
Output Bias Current	VOU α	I _{out}	-3.0	-7.0	-10.0	mA		1, 4, 5

- α denotes a, b, c or d
- The maximum DC current is for one output. I_{dd} = I_{out} + I_{ss}. See Figure 17.
- The operating value of the substrate voltage, VAB, will be marked on the shipping container for each device. The value of VAB is set such that the photodiode charge capacity is the nominal PNe (see Specifications).
- An output load sink must be applied to each VOUT pin to activate each output amplifier.
- Nominal value required for 40 MHz operation per output. May be reduced for slower data rates and lower noise.
- Adherence to the power-up and power-down sequence is critical. See Power-Up and Power-Down Sequence section.
- ESD maximum value must be less than or equal to V1_L + 0.4 V and V2_L + 0.4 V
- Refer to Application Note *Using Interline CCD Image Sensors in High Intensity Visible Lighting Conditions*
- Where V_{x_L} is the level set for V1_L, V2_L, V3_L, or V4_L in the application.



Figure 17. Output Amplifier

AC Operating Conditions

Table 18. CLOCK LEVELS

Description	Pins ¹	Symbol	Level	Minimum	Nominal	Maximum	Units	Capacitance ²
Vertical CCD Clock, Phase 1	V1B, V1T	V1_L	Low	-8.2	-8.0	-7.8	V	180 nF (6)
		V1_M	Mid	-0.2	0.0	+0.2		
		V1_H	High	+11.5	+12.0	+12.5		
Vertical CCD Clock, Phase 2	V2B, V2T	V2_L	Low	-8.2	-8.0	-7.8	V	180 nF (6)
		V2_H	High	-0.2	0.0	+0.2		
Vertical CCD Clock, Phase 3	V3B, V3T	V3_L	Low	-8.2	-8.0	-7.8	V	180 nF (6)
		V3_H	High	-0.2	0.0	+0.2		
Vertical CCD Clock, Phase 4	V4B, V4T	V4_L	Low	-8.2	-8.0	-7.8	V	180 nF (6)
		V4_H	High	-0.2	0.0	+0.2		
Horizontal CCD Clock, Phase 1 Storage	H1S α	H1S_L	Low	-5.2 (7)	-4.0	-3.8	V	600 pF (6)
		H1S_A	Amplitude	+3.8	+4.0	+5.2 (7)		
Horizontal CCD Clock, Phase 1 Barrier	H1B α	H1B_L	Low	-5.2 (7)	-4.0	-3.8	V	400 pF (6)
		H1B_A	Amplitude	+3.8	+4.0	+5.2 (7)		
Horizontal CCD Clock, Phase 2 Storage	H2S α	H2S_L	Low	-5.2 (7)	-4.0	-3.8	V	580 pF (6)
		H2S_A	Amplitude	+3.8	+4.0	+5.2 (7)		
Horizontal CCD Clock, Phase 2 Barrier	H2B α	H2B_L	Low	-5.2 (7)	-4.0	-3.8	V	400 pF (6)
		H2B_A	Amplitude	+3.8	+4.0	+5.2 (7)		
Horizontal CCD Clock, Last Phase ³	H2SL α	H2SL_L	Low	-5.2	-5.0	-4.8	V	20 pF (6)
		H2SL_A	Amplitude	+4.8	+5.0	+5.2		
Reset Gate	R α	R_L ⁴	Low	-3.5	-2.0	-1.5	V	16 pF (6)
		R_H	High	+2.5	+3.0	+4.0		
Electronic Shutter ⁵	SUB	VES	High	+29.0	+30.0	+40.0	V	12 nF (6)
Fast Line Dump Gate	FDG α	FDG_L	Low	-8.2	-8.0	-7.8	V	50 pF (6)
		FDG_H	High	+4.5	+5.0	+5.5		

- α denotes a, b, c or d
- Capacitance is total for all like named pins
- Use separate clock driver for improved speed performance.
- Reset low should be set to -3 volts for signal levels greater than 40,000 electrons.
- Refer to Application Note *Using Interline CCD Image Sensors in High Intensity Visible Lighting Conditions*
- Capacitance values are estimated
- If the minimum horizontal clock low level is used (-5.2 V), then the maximum horizontal clock amplitude should be used (5.2 V amplitude) to create a -5.2 V to 0.0 V clock. If a 5 V clock driver is used, the horizontal low level should be set to -5.0 V and the high level should be set to 0.0 V.

The figure below shows the DC bias (V_{SUB}) and AC clock (VES) applied to the SUB pin. Both the DC bias and AC clock are referenced to ground.

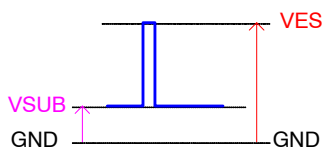

Figure 18.

Device Identification

The device identification pin (DevID) may be used to determine which ON Semiconductor 5.5 micron pixel interline CCD sensor is being used.

Table 19. DEVICE IDENTIFICATION

Description	Pins	Symbol	Minimum	Nominal	Maximum	Units	Maximum DC Current	Notes
Device Identification	DevID	DevID	144,000	180,000	216,000	Ω	50 μ A	1, 2, 3

1. Nominal value subject to verification and/or change during release of preliminary specifications.
2. If the Device Identification is not used, it may be left disconnected.
3. After Device Identification resistance has been read during camera initialization, it is recommended that the circuit be disabled to prevent localized heating of the sensor due to current flow through the R_DeviceID resistor.

Recommended Circuit

Note that V1 must be a different value than V2.



Figure 19. Device Identification Recommended Circuit

TIMING

Table 20. REQUIREMENTS AND CHARACTERISTICS

Description	Symbol	Minimum	Nominal	Maximum	Units	Notes
Photodiode Transfer	t_{pd}	3	–	–	μs	
VCCD Leading Pedestal	t_{3p}	4	–	–	μs	
VCCD Trailing Pedestal	t_{3d}	4	–	–	μs	
VCCD Transfer Delay	t_d	4	–	–	μs	
VCCD Transfer	t_v	4	–	–	μs	
VCCD Clock Cross-over	v_{VCR}	75	–	100	%	1
VCCD Rise, Fall Times	t_{VR}, t_{VF}	5	–	10	%	1, 2
FDG Delay	t_{fdg}	2	–	–	μs	
HCCD Delay	t_{hs}	1	–	–	μs	
HCCD Transfer	t_e	25.0	–	–	ns	
Shutter Transfer	t_{sub}	1	–	–	μs	
Shutter Delay	t_{hd}	1	–	–	μs	
Reset Pulse	t_r	2.5	–	–	ns	
Reset – Video Delay	t_{rv}	–	2.2	–	ns	
H2SL – Video Delay	t_{hv}	–	3.1	–	ns	
Line Time	t_{line}	69.3	–	–	μs	Dual HCCD Readout
		131.4	–	–		Single HCCD Readout
Frame Time	t_{frame}	115.5	–	–	ms	Quad HCCD Readout
		231.1	–	–		Dual HCCD Readout
		437.8	–	–		Single HCCD Readout

1. Refer to Figure 25: VCCD Clock Rise Time, Fall Time and Edge Alignment
2. Relative to the pulse width
3. Refer to timing diagrams as shown in Figures 21, 22, 23, 24 and 25.

Timing Diagrams

The timing sequence for the clocked device pins may be represented as one of seven patterns (P1–P7) as shown in the table below. The patterns are defined in Figure 21 and

Figure 22. Contact ON Semiconductor Imaging Application Engineering for other readout modes.

Table 21.

Device Pin	Quad Readout	Dual Readout VOUTa, VOUTb	Dual Readout VOUTa, VOUTc	Single Readout VOUTa
V1T	P1T	P1B	P1T	P1B
V2T	P2T	P4B	P2T	P4B
V3T	P3T	P3B	P3T	P3B
V4T	P4T	P2B	P4T	P2B
V1B	P1B			
V2B	P2B			
V3B	P3B			
V4B	P4B			
H1Sa	P5			
H1Ba				
H2Sa ²	P6			
H2Ba				
Ra	P7			
H1Sb	P5		P5	
H1Bb			P6	
H2Sb ²	P6		P6	
H2Bb			P5	
Rb	P7		P7 ¹ or Off ³	P7 ¹ or Off ³
H1Sc	P5	P5 ¹ or Off ³	P5	P5 ¹ or Off ³
H1Bc				
H2Sc ²	P6	P6 ¹ or Off ³	P6	P6 ¹ or Off ³
H2Bc				
Rc	P7	P7 ¹ or Off ³	P7	P7 ¹ or Off ³
H1Sd	P5	P5 ¹ or Off ³	P5	P5 ¹ or Off ³
H1Bd			P6	
H2Sd ²	P6	P6 ¹ or Off ³	P6	P6 ¹ or Off ³
H2Bd			P5	
Rd	P7	P7 ¹ or Off ³	P7 ¹ or Off ³	P7 ¹ or Off ³

# Lines/Frame (Minimum)	1666	3332	1666	3332
# Pixels/Line (Minimum)	2492		4984	

1. For optimal performance of the sensor. May be clocked at a lower frequency. If clocked at a lower frequency, the frequency selected should be a multiple of the frequency used on the a and b register.
2. H2SLx follows the same pattern as H2Sx For optimal speed performance, use a separate clock driver.
3. Off = +5 V. Note that there may be operating conditions (high temperature and/or very bright light sources) that will cause blooming from the unused c/d register into the image area.

Photodiode Transfer Timing

A row of charge is transferred to the HCCD on the falling edge of V1 as indicated in the P1 pattern below. Using this timing sequence, the leading dummy row or line is combined with the first dark row in the HCCD. The “Last Line” is dependent on readout mode – either 1666 or 3332 minimum counts required. It is important to note that, in

general, the rising edge of a vertical clock (patterns P1–P4) should be coincident or slightly leading a falling edge at the same time interval. This is particularly true at the point where P1 returns from the high (3rd level) state to the mid-state when P4 transitions from the low state to the high state.

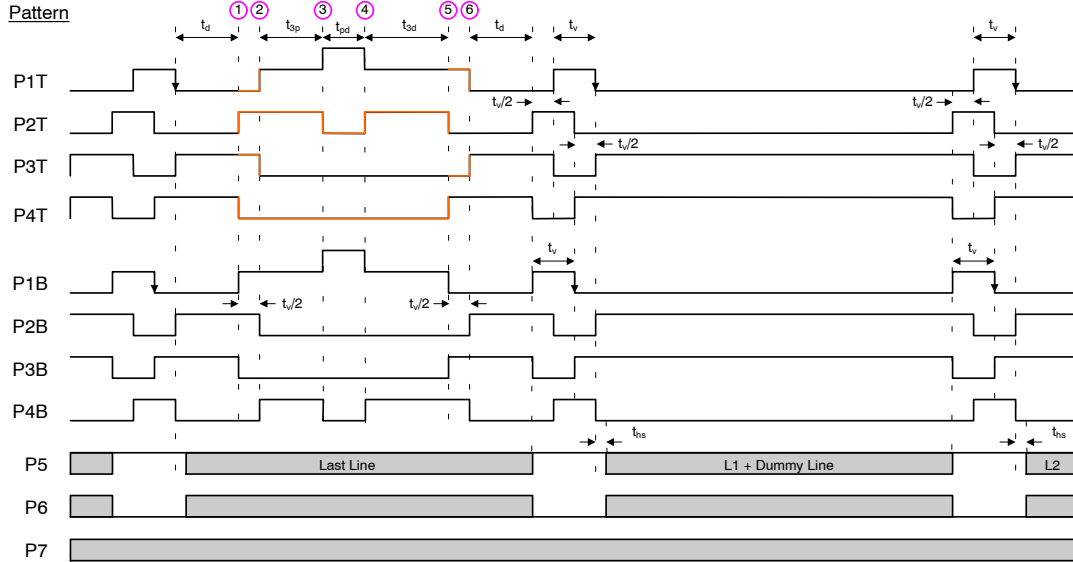

Figure 20. Photodiode Transfer Timing

Line and Pixel Timing

Each row of charge is transferred to the output, as illustrated below, on the falling edge of H2SL (indicated as P6 pattern). The number of pixels in a row is dependent on

readout mode – either 2492 or 4984 minimum counts required.



Figure 21. Line and Pixel Timing

Pixel Timing Detail

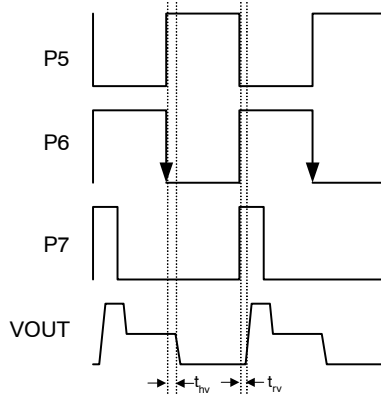

Figure 22. Pixel Timing Detail

Frame/Electronic Shutter Timing

The SUB pin may be optionally clocked to provide electronic shuttering capability as shown below.

The resulting photodiode integration time is defined from the falling edge of SUB to the falling edge of V1 (P1 pattern).

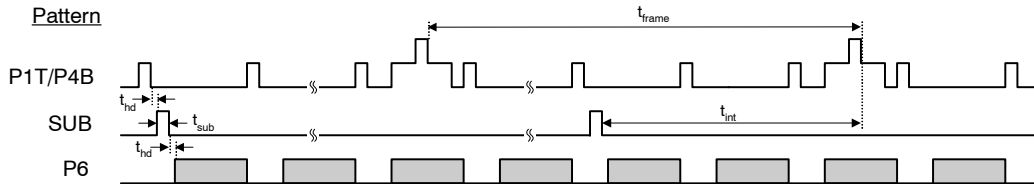

Figure 23. Frame/Electronic Shutter Timing

VCCD Clock Edge Alignment



Figure 24. VCCD Clock Rise Time, Fall Time and Edge Alignment

Line and Pixel Timing – Vertical Binning by 2



Figure 25. Line and Pixel Timing – Vertical Binning by 2

Fast Line Dump Timing

The FDG pins may be optionally clocked to efficiently remove unwanted lines in the image resulting for increased frame rates at the expense of resolution. Below is an example of a 2 line dump sequence followed by a normal readout line.

Note that the FDG timing transitions should complete prior to the beginning of V1 timing transitions as illustrated below.



Figure 26. Fast Line Dump Timing

STORAGE AND HANDLING

Table 22. STORAGE CONDITIONS

Description	Symbol	Minimum	Maximum	Units	Notes
Storage Temperature	T _{ST}	-55	+80	°C	1
Humidity	RH	5	90	%	2

1. Long term storage toward the maximum temperature will accelerate color filter degradation.
2. T = 25°C. Excessive humidity will degrade MTTF.

For information on ESD and cover glass care and cleanliness, please download the *Image Sensor Handling and Best Practices* Application Note (AN52561/D) from www.onsemi.com.

For information on soldering recommendations, please download the *Soldering and Mounting Techniques Reference Manual* (SOLDERRM/D) from www.onsemi.com.

For quality and reliability information, please download the *Quality & Reliability Handbook* (HBD851/D) from www.onsemi.com.

For information on device numbering and ordering codes, please download the *Device Nomenclature* technical note (TND310/D) from www.onsemi.com.

For information on Standard terms and Conditions of Sale, please download [Terms and Conditions](http://www.onsemi.com) from www.onsemi.com.

MECHANICAL INFORMATION

Completed Assembly



Notes:

1. See Ordering Information for marking code.
2. No materials to interfere with clearance through package holes.
3. Units: IN [MM]

Figure 27. Completed Assembly (1 of 2)

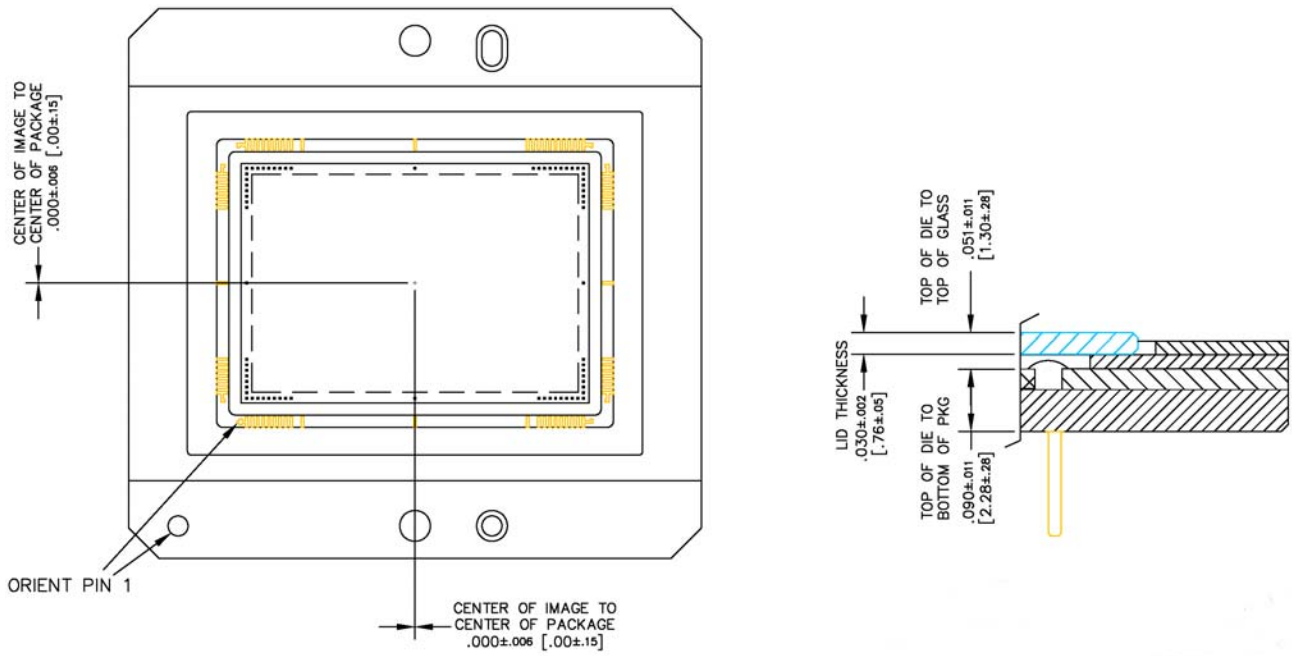

Notes:

- 1. Units IN [MM]

Figure 28. Completed Assembly (2 of 2)

Cover Glass

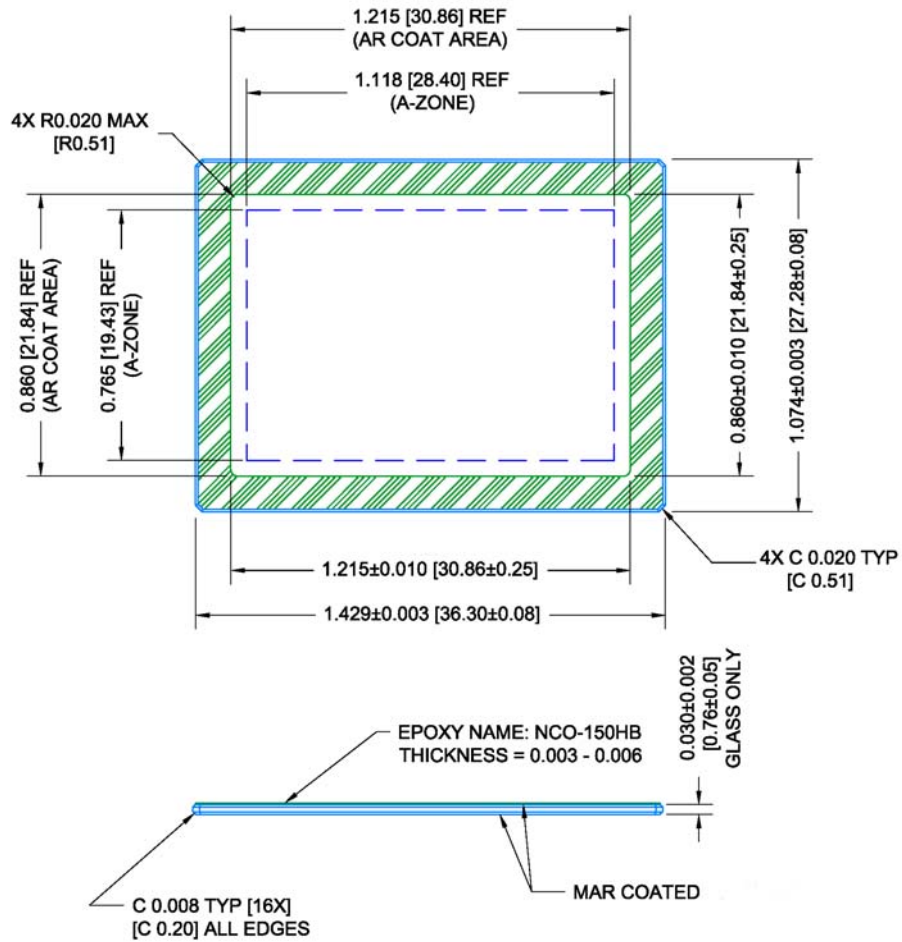

Notes:

1. Substrate = Schott D263T eco
2. Dust, Scratch, Inclusion Specification:
 - a.) 20 μm Max size in Zone A
3. MAR coated both sides
4. Spectral Transmission
 - a.) 350 - 365 nm: $T \geq 88\%$
 - b.) 365 - 405 nm: $T \geq 94\%$
 - c.) 405 - 450 nm: $T \geq 98\%$
 - d.) 450 - 650 nm: $T \geq 99\%$
 - e.) 650 - 690 nm: $T \geq 98\%$
 - f.) 690 - 770 nm: $T \geq 94\%$
 - g.) 770 - 870 nm: $T \geq 88\%$
5. Units: IN [MM]

Figure 29. Cover Glass

Cover Glass Transmission



Figure 30. Cover Glass Transmission

ON Semiconductor and the  are registered trademarks of Semiconductor Components Industries, LLC (SCILLC) or its subsidiaries in the United States and/or other countries. SCILLC owns the rights to a number of patents, trademarks, copyrights, trade secrets, and other intellectual property. A listing of SCILLC's product/patent coverage may be accessed at www.onsemi.com/site/pdf/Patent-Marking.pdf. SCILLC reserves the right to make changes without further notice to any products herein. SCILLC makes no warranty, representation or guarantee regarding the suitability of its products for any particular purpose, nor does SCILLC assume any liability arising out of the application or use of any product or circuit, and specifically disclaims any and all liability, including without limitation special, consequential or incidental damages. "Typical" parameters which may be provided in SCILLC data sheets and/or specifications can and do vary in different applications and actual performance may vary over time. All operating parameters, including "Typicals" must be validated for each customer application by customer's technical experts. SCILLC does not convey any license under its patent rights nor the rights of others. SCILLC products are not designed, intended, or authorized for use as components in systems intended for surgical implant into the body, or other applications intended to support or sustain life, or for any other application in which the failure of the SCILLC product could create a situation where personal injury or death may occur. Should Buyer purchase or use SCILLC products for any such unintended or unauthorized application, Buyer shall indemnify and hold SCILLC and its officers, employees, subsidiaries, affiliates, and distributors harmless against all claims, costs, damages, and expenses, and reasonable attorney fees arising out of, directly or indirectly, any claim of personal injury or death associated with such unintended or unauthorized use, even if such claim alleges that SCILLC was negligent regarding the design or manufacture of the part. SCILLC is an Equal Opportunity/Affirmative Action Employer. This literature is subject to all applicable copyright laws and is not for resale in any manner.

PUBLICATION ORDERING INFORMATION

LITERATURE FULFILLMENT:
 Literature Distribution Center for ON Semiconductor
 19521 E. 32nd Pkwy, Aurora, Colorado 80011 USA
Phone: 303-675-2175 or 800-344-3860 Toll Free USA/Canada
Fax: 303-675-2176 or 800-344-3867 Toll Free USA/Canada
Email: orderlit@onsemi.com

N. American Technical Support: 800-282-9855 Toll Free
 USA/Canada
Europe, Middle East and Africa Technical Support:
 Phone: 421 33 790 2910
Japan Customer Focus Center
 Phone: 81-3-5817-1050

ON Semiconductor Website: www.onsemi.com
Order Literature: <http://www.onsemi.com/orderlit>
 For additional information, please contact your local
 Sales Representative



Компания «ЭлектроПласт» предлагает заключение долгосрочных отношений при поставках импортных электронных компонентов на взаимовыгодных условиях!

Наши преимущества:

- Оперативные поставки широкого спектра электронных компонентов отечественного и импортного производства напрямую от производителей и с крупнейших мировых складов;
- Поставка более 17-ти миллионов наименований электронных компонентов;
- Поставка сложных, дефицитных, либо снятых с производства позиций;
- Оперативные сроки поставки под заказ (от 5 рабочих дней);
- Экспресс доставка в любую точку России;
- Техническая поддержка проекта, помощь в подборе аналогов, поставка прототипов;
- Система менеджмента качества сертифицирована по Международному стандарту ISO 9001;
- Лицензия ФСБ на осуществление работ с использованием сведений, составляющих государственную тайну;
- Поставка специализированных компонентов (Xilinx, Altera, Analog Devices, Intersil, Interpoint, Microsemi, Aeroflex, Peregrine, Syfer, Eurofarad, Texas Instrument, Miteq, Cobham, E2V, MA-COM, Hittite, Mini-Circuits, General Dynamics и др.);

Помимо этого, одним из направлений компании «ЭлектроПласт» является направление «Источники питания». Мы предлагаем Вам помощь Конструкторского отдела:

- Подбор оптимального решения, техническое обоснование при выборе компонента;
- Подбор аналогов;
- Консультации по применению компонента;
- Поставка образцов и прототипов;
- Техническая поддержка проекта;
- Защита от снятия компонента с производства.



Как с нами связаться

Телефон: 8 (812) 309 58 32 (многоканальный)

Факс: 8 (812) 320-02-42

Электронная почта: org@eplast1.ru

Адрес: 198099, г. Санкт-Петербург, ул. Калинина, дом 2, корпус 4, литера А.