

NL27WZ07

Dual Buffer with Open Drain Outputs

The NL27WZ07 is a high performance dual buffer with open drain outputs operating from a 1.65 to 5.5 V supply.

The internal circuit is composed of multiple stages, including an open drain output. The open drain output provides the capability to set the output switching level to a user selectable value with an external resistor and power supply. The logic high output value is set by the external power supply and can be less than, equal or greater than the V_{CC} power supply, provided the voltage supply is less than 5.5 V.

Features

- Extremely High Speed: t_{PD} 2.3 ns (typical) at $V_{CC} = 5$ V
- Designed for 1.65 V to 5.5 V V_{CC} Operation, CMOS compatible
- Over Voltage Tolerant Inputs
- LVTTL Compatible – Interface Capability with 5 V TTL Logic with $V_{CC} = 3$ V
- LVC MOS Compatible
- 24 mA Output Sink Capability
- Near Zero Static Supply Current Substantially Reduces System Power Requirements
- Chip Complexity: FET = 72; Equivalent Gate = 18
- These Devices are Pb-Free and are RoHS Compliant
- NLV Prefix for Automotive and Other Applications Requiring Unique Site and Control Change Requirements; AEC-Q100 Qualified and PPAP Capable

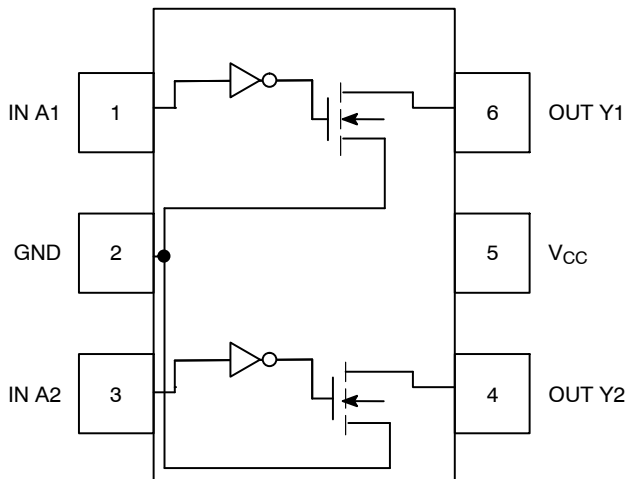

Figure 1. Pinout (Top View)

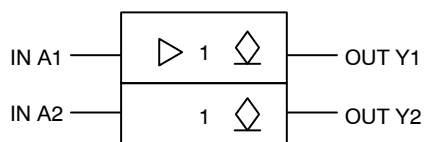

Figure 2. Logic Symbol



ON Semiconductor®

<http://onsemi.com>

MARKING DIAGRAMS



SC-88
DF SUFFIX
CASE 419B

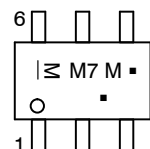

TSOP-6
DT SUFFIX
CASE 318G

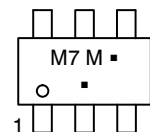

M7 = Device Code
M = Date Code*
▪ = Pb-Free Package

(Note: Microdot may be in either location)

*Date Code orientation and/or position may vary depending upon manufacturing location.

PIN ASSIGNMENT

Pin	Function
1	IN A1
2	GND
3	IN A2
4	OUT Y2
5	V_{CC}
6	OUT Y1

FUNCTION TABLE

A Input	Y Output
L	L
H	Z

ORDERING INFORMATION

See detailed ordering and shipping information in the package dimensions section on page 4 of this data sheet.

MAXIMUM RATINGS

Symbol	Characteristics	Value	Units
V _{CC}	DC Supply Voltage	-0.5 to +7.0	V
V _I	DC Input Voltage	-0.5 ≤ V _I ≤ +7.0	V
V _O	DC Output Voltage Output in Z or LOW State (Note 1)	-0.5 ≤ V _O ≤ +7.0	V
I _{IK}	DC Input Diode Current V _I < GND	-50	mA
I _{OK}	DC Output Diode Current V _O < GND	-50	mA
I _O	DC Output Sink Current	±50	mA
I _{CC}	DC Supply Current per Supply Pin	±100	mA
I _{GND}	DC Ground Current per Ground Pin	±100	mA
T _{STG}	Storage Temperature Range	-65 to +150	°C
P _D	Power Dissipation in Still Air SC-88, TSOP-6	200	mW
θ _{JA}	Thermal Resistance SC-88, TSOP-6	333	°C/W
T _L	Lead Temperature, 1 mm from case for 10 s	260	°C
T _J	Junction Temperature under Bias	+150	°C
I _{Latchup}	Latchup Performance Above V _{CC} and Below GND at 85°C (Note 5)	±500	mA
MSL	Moisture Sensitivity	Level 1	
F _R	Flammability Rating Oxygen Index: 28 to 34	UL 94 V-0 @ 0.125 in	
V _{ESD}	ESD Classification Human Body Model (Note 3) Machine Model (Note 4) Charged Device Model (Note 5)	> 2000 > 200 N/A	V

Stresses exceeding Maximum Ratings may damage the device. Maximum Ratings are stress ratings only. Functional operation above the Recommended Operating Conditions is not implied. Extended exposure to stresses above the Recommended Operating Conditions may affect device reliability.

1. I_O absolute maximum rating must be observed.
2. Tested to EIA/JESD22-A114-A, rated to EIA/JESD22-A114-B.
3. Tested to EIA/JESD22-A115-A, rated to EIA/JESD22-A115-A.
4. Tested to JESD22-C101-A
5. Tested to EIA/JESD78

RECOMMENDED OPERATING CONDITIONS

Symbol	Parameter	Min	Max	Units
V _{CC}	Supply Voltage Operating Data Retention Only	1.65 1.5	5.5 5.5	V
V _I	Input Voltage	0	5.5	V
V _O	Output Voltage (Z or LOW State)	0	5.5	V
T _A	Operating Free-Air Temperature	-55	+125	°C
Δt/ΔV	Input Transition Rise or Fall Rate V _{CC} = 2.5 V ±0.2 V V _{CC} = 3.0 V ±0.3 V V _{CC} = 5.0 V ±0.5 V	0 0 0	20 10 5	ns/V

NL27WZ07

DC ELECTRICAL CHARACTERISTICS

Symbol	Parameter	Condition	V _{CC} (V)	T _A = 25°C			-55°C ≤ T _A ≤ 125°C		Units
				Min	Typ	Max	Min	Max	
V _{IH}	High-Level Input Voltage		1.65 to 1.95 2.3 to 5.5	0.75 V _{CC} 0.7 V _{CC}			0.75 V _{CC} 0.7 V _{CC}		V
V _{IL}	Low-Level Input Voltage		1.65 to 1.95 2.3 to 5.5			0.25 V _{CC} 0.3 V _{CC}		0.25 V _{CC} 0.3 V _{CC}	V
I _{LKG}	Z-State Output Leakage Current	V _{IN} = V _{IL} V _{OUT} = V _{CC} or GND	2.3 to 5.5			±5.0		±10.0	μA
V _{OL}	Low-Level Output Voltage V _{IN} = V _{IL}	I _{OL} = 100 μA	1.65 to 5.5		0.0	0.1		0.1	V
		I _{OL} = 4 mA	1.65		0.08	0.24		0.24	
		I _{OL} = 8 mA	2.3		0.20	0.3		0.3	
		I _{OL} = 12 mA	2.7		0.22	0.4		0.4	
		I _{OL} = 16 mA	3.0		0.28	0.4		0.4	
		I _{OL} = 24 mA	3.0		0.38	0.55		0.55	
		I _{OL} = 32 mA	4.5		0.42	0.55		0.55	
I _{IN}	Input Leakage Current	V _{IN} = 5.5 V or GND	0 to 5.5			±0.1		±1.0	μA
I _{OFF}	Power Off Leakage Current	V _{IN} = 5.5 V or V _{OUT} = 5.5 V	0			1		10	μA
I _{CC}	Quiescent Supply Current	V _{IN} = 5.5 V or GND	5.5			1		10	μA

AC ELECTRICAL CHARACTERISTICS t_R = t_F = 2.5 ns; C_L = 50 pF; R_L = 500 Ω

Symbol	Parameter	Condition	V _{CC} (V)	T _A = 25°C			-55°C ≤ T _A ≤ 125°C		Units
				Min	Typ	Max	Min	Max	
t _{PZL}	Propagation Delay (Figure 3 and 4)	R _L = R ₁ = 5000 Ω, C _L = 15 pF	1.8 ± 0.15	1.8	5.3	11.5	1.8	12.0	ns
			2.5 ± 0.2	1.2	3.7	5.8	1.2	6.4	
		R _L = R ₁ = 500 Ω, C _L = 50 pF	3.3 ± 0.3	0.8	2.9	4.4	0.8	4.8	
			5.0 ± 0.5	0.5	2.3	3.5	0.5	3.9	
t _{PLZ}	Propagation Delay (Figure 3 and 4)	R _L = R ₁ = 5000 Ω, C _L = 15 pF	1.8 ± 0.15	1.8	5.3	11.5	1.8	12.0	ns
			2.5 ± 0.2	1.2	2.8	5.8	1.2	6.4	
		R _L = R ₁ = 500 Ω, C _L = 50 pF	3.3 ± 0.3	0.8	2.1	4.4	0.8	4.8	
			5.0 ± 0.5	0.5	1.4	3.5	0.5	3.9	

CAPACITIVE CHARACTERISTICS

Symbol	Parameter	Condition	Typical	Units
C _{IN}	Input Capacitance	V _{CC} = 5.5 V, V _I = 0 V or V _{CC}	2.5	pF
C _{OUT}	Output Capacitance	V _{CC} = 5.5 V, V _I = 0 V or V _{CC}	4.0	pF
C _{PD}	Power Dissipation Capacitance (Note 6)	10 MHz, V _{CC} = 5.5 V, V _I = 0 V or V _{CC}	4.0	pF

6. C_{PD} is defined as the value of the internal equivalent capacitance which is calculated from the operating current consumption without load. Average operating current can be obtained by the equation: I_{CC(OPR)} = C_{PD} • V_{CC} • f_{in} + I_{CC}. C_{PD} is used to determine the no-load dynamic power consumption; P_D = C_{PD} • V_{CC}² • f_{in} + I_{CC} • V_{CC}.

NL27WZ07

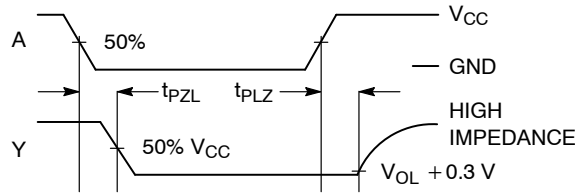
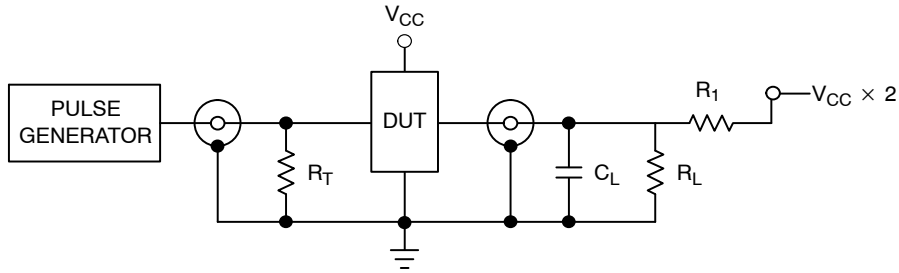

Figure 3. Switching Waveforms



$R_T = Z_{OUT}$ of pulse generator (typically 50 Ω)

Figure 4. Test Circuit

ORDERING INFORMATION

Device	Package	Shipping [†]
NL27WZ07DFT2G	SC-88 / SOT-363 / SC-70-6 (Pb-Free)	3000 / Tape & Reel
NLV27WZ07DFT2G*	SC-88 / SOT-363 / SC-70-6 (Pb-Free)	3000 / Tape & Reel
NL27WZ07DTT1G	TSOP-6 (Pb-Free)	3000 / Tape & Reel

[†]For information on tape and reel specifications, including part orientation and tape sizes, please refer to our Tape and Reel Packaging Specifications Brochure, BRD8011/D.

*NLV Prefix for Automotive and Other Applications Requiring Unique Site and Control Change Requirements; AEC-Q100 Qualified and PPAP Capable.

NL27WZ07

PACKAGE DIMENSIONS

SC-88/SC70-6/SOT-363
CASE 419B-02
ISSUE W

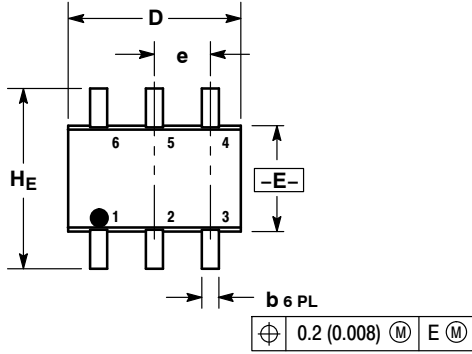

NOTES:

1. DIMENSIONING AND TOLERANCING PER ANSI Y14.5M, 1982.
2. CONTROLLING DIMENSION: INCH.
3. 419B-01 OBSOLETE, NEW STANDARD 419B-02.

DIM	MILLIMETERS			INCHES		
	MIN	NOM	MAX	MIN	NOM	MAX
A	0.80	0.95	1.10	0.031	0.037	0.043
A1	0.00	0.05	0.10	0.000	0.002	0.004
A3	0.20 REF			0.008 REF		
b	0.10	0.21	0.30	0.004	0.008	0.012
C	0.10	0.14	0.25	0.004	0.005	0.010
D	1.80	2.00	2.20	0.070	0.078	0.086
E	1.15	1.25	1.35	0.045	0.049	0.053
e	0.65 BSC			0.026 BSC		
L	0.10	0.20	0.30	0.004	0.008	0.012
HE	2.00	2.10	2.20	0.078	0.082	0.086

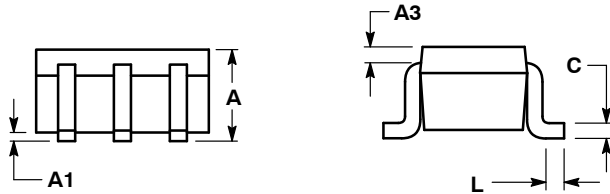

SOLDERING FOOTPRINT*

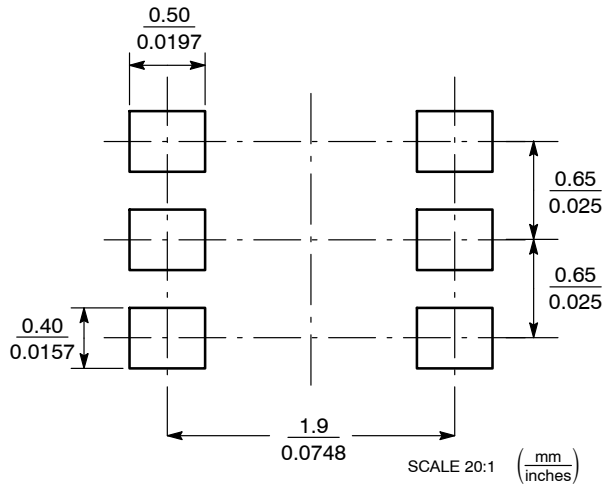

*For additional information on our Pb-Free strategy and soldering details, please download the ON Semiconductor Soldering and Mounting Techniques Reference Manual, SOLDERRM/D.

NL27WZ07

PACKAGE DIMENSIONS

TSOP-6 CASE 318G-02 ISSUE U

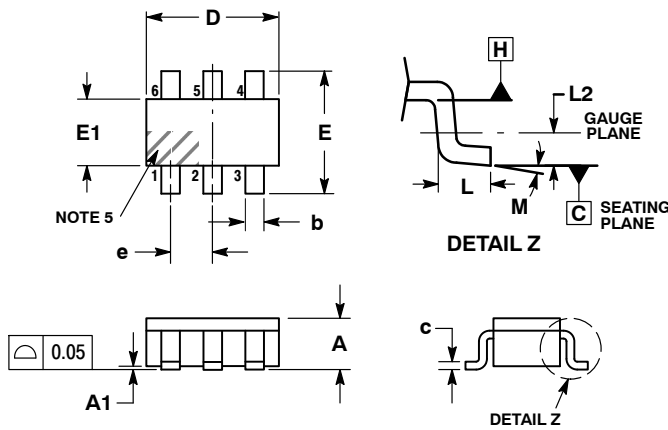

NOTES:

1. DIMENSIONING AND TOLERANCING PER ASME Y14.5M, 1994.
2. CONTROLLING DIMENSION: MILLIMETERS.
3. MAXIMUM LEAD THICKNESS INCLUDES LEAD FINISH. MINIMUM LEAD THICKNESS IS THE MINIMUM THICKNESS OF BASE MATERIAL.
4. DIMENSIONS D AND E1 DO NOT INCLUDE MOLD FLASH, PROTRUSIONS, OR GATE BURRS. MOLD FLASH, PROTRUSIONS, OR GATE BURRS SHALL NOT EXCEED 0.15 PER SIDE. DIMENSIONS D AND E1 ARE DETERMINED AT DATUM H.
5. PIN ONE INDICATOR MUST BE LOCATED IN THE INDICATED ZONE.

DIM	MILLIMETERS		
	MIN	NOM	MAX
A	0.90	1.00	1.10
A1	0.01	0.06	0.10
b	0.25	0.38	0.50
c	0.10	0.18	0.26
D	2.90	3.00	3.10
E	2.50	2.75	3.00
E1	1.30	1.50	1.70
e	0.85	0.95	1.05
L	0.20	0.40	0.60
L2	0.25 BSC		
M	0°	-	10°

RECOMMENDED SOLDERING FOOTPRINT*

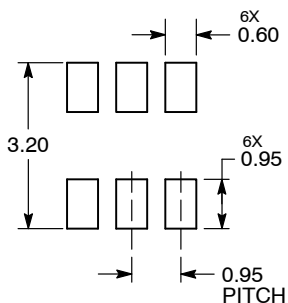

DIMENSIONS: MILLIMETERS

*For additional information on our Pb-Free strategy and soldering details, please download the ON Semiconductor Soldering and Mounting Techniques Reference Manual, SOLDERRM/D.

ON Semiconductor and are registered trademarks of Semiconductor Components Industries, LLC (SCILLC). SCILLC reserves the right to make changes without further notice to any products herein. SCILLC makes no warranty, representation or guarantee regarding the suitability of its products for any particular purpose, nor does SCILLC assume any liability arising out of the application or use of any product or circuit, and specifically disclaims any and all liability, including without limitation special, consequential or incidental damages. "Typical" parameters which may be provided in SCILLC data sheets and/or specifications can and do vary in different applications and actual performance may vary over time. All operating parameters, including "Typicals" must be validated for each customer application by customer's technical experts. SCILLC does not convey any license under its patent rights nor the rights of others. SCILLC products are not designed, intended, or authorized for use as components in systems intended for surgical implant into the body, or other applications intended to support or sustain life, or for any other application in which the failure of the SCILLC product could create a situation where personal injury or death may occur. Should Buyer purchase or use SCILLC products for any such unintended or unauthorized application, Buyer shall indemnify and hold SCILLC and its officers, employees, subsidiaries, affiliates, and distributors harmless against all claims, costs, damages, and expenses, and reasonable attorney fees arising out of, directly or indirectly, any claim of personal injury or death associated with such unintended or unauthorized use, even if such claim alleges that SCILLC was negligent regarding the design or manufacture of the part. SCILLC is an Equal Opportunity/Affirmative Action Employer. This literature is subject to all applicable copyright laws and is not for resale in any manner.

PUBLICATION ORDERING INFORMATION

LITERATURE FULFILLMENT:
Literature Distribution Center for ON Semiconductor
P.O. Box 5163, Denver, Colorado 80217 USA
Phone: 303-675-2175 or 800-344-3860 Toll Free USA/Canada
Fax: 303-675-2176 or 800-344-3867 Toll Free USA/Canada
Email: orderlit@onsemi.com

N. American Technical Support: 800-282-9855 Toll Free
USA/Canada
Europe, Middle East and Africa Technical Support:
Phone: 421 33 790 2910
Japan Customer Focus Center
Phone: 81-3-5817-1050

ON Semiconductor Website: www.onsemi.com
Order Literature: <http://www.onsemi.com/orderlit>

For additional information, please contact your local Sales Representative



Компания «ЭлектроПласт» предлагает заключение долгосрочных отношений при поставках импортных электронных компонентов на взаимовыгодных условиях!

Наши преимущества:

- Оперативные поставки широкого спектра электронных компонентов отечественного и импортного производства напрямую от производителей и с крупнейших мировых складов;
- Поставка более 17-ти миллионов наименований электронных компонентов;
- Поставка сложных, дефицитных, либо снятых с производства позиций;
- Оперативные сроки поставки под заказ (от 5 рабочих дней);
- Экспресс доставка в любую точку России;
- Техническая поддержка проекта, помощь в подборе аналогов, поставка прототипов;
- Система менеджмента качества сертифицирована по Международному стандарту ISO 9001;
- Лицензия ФСБ на осуществление работ с использованием сведений, составляющих государственную тайну;
- Поставка специализированных компонентов (Xilinx, Altera, Analog Devices, Intersil, Interpoint, Microsemi, Aeroflex, Peregrine, Syfer, Eurofarad, Texas Instrument, Miteq, Cobham, E2V, MA-COM, Hittite, Mini-Circuits, General Dynamics и др.);

Помимо этого, одним из направлений компании «ЭлектроПласт» является направление «Источники питания». Мы предлагаем Вам помощь Конструкторского отдела:

- Подбор оптимального решения, техническое обоснование при выборе компонента;
- Подбор аналогов;
- Консультации по применению компонента;
- Поставка образцов и прототипов;
- Техническая поддержка проекта;
- Защита от снятия компонента с производства.



Как с нами связаться

Телефон: 8 (812) 309 58 32 (многоканальный)

Факс: 8 (812) 320-02-42

Электронная почта: org@eplast1.ru

Адрес: 198099, г. Санкт-Петербург, ул. Калинина, дом 2, корпус 4, литера А.