

SINGLE ISOLATION AMPLIFIER

■ GENERAL DESCRIPTION

NJM2505A is the single isolation amplifier developed by the video signal. It can remove the noise of a signal with isolation amplifier and carries in the small package (MTP5), it is suitable for the interface of the video signal of a car AV system.

■ FEATURES

- Operating Voltage 4.5 to 9.0V
- Input: Sync-tip Clamp
- Common Mode Noise Rejection Ratio -55dBtyp.
- Voltage Gain 0dBtyp.
- Frequency Characteristics 0dBtyp.at 10MHz
- Bipolar Technology
- Package MTP5

■ PIN CONFIGURATION

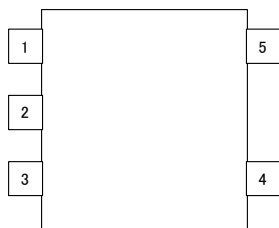

- 1: Vout
- 2: GND
- 3: V+
- 4: Vin
- 5: VGND

■ PACKAGE OUTLINE



NJM2505AF

■ BLOCK DIAGRAM

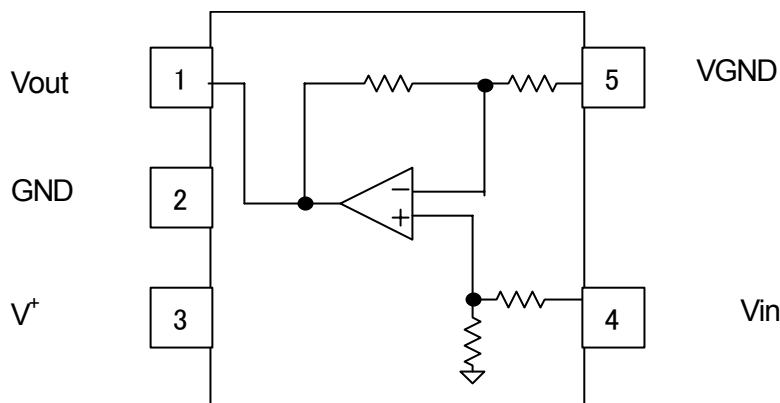

NJM2505A

■ ABSOLUTE MAXIMUM RATINGS(Ta=25°C)

PARAMETER	SYMBOL	RATINGS	UNIT
Supply Voltage	V ⁺	15.0	V
Power Dissipation	P _D	200	MW
Operating Temperature Range	Topr	-40 to +85	°C
Storage Temperature Range	Tstg	-40 to +125	°C

■ RECOMMENDED OPERATING CONDITION(Ta=25°C)

PARAMETER	SYMBOL	TEST CONDITION	MIN.	TYP.	MAX.	UNIT
Operating Voltage Range	Vopr		4.5	-	9.0	V

■ ELECTRICAL CHARACTERISTICS(V⁺ =5.0V, Ta=25°C)

PARAMETR	SYMBOL	TEST CONDITION	MIN.	TYP.	MAX.	UNIT
Supply Current	I _{CC}	No Signal	-	3.0	6.0	mA
Maximum Output Voltage Level	Vom	Vin=100kHz, Sin-Signal, THD=1%,	2.0	2.2	-	Vp-p
Voltage Gain	Gv	Vin=100kHz, 1.0Vp-p, Sin-Signal	-1.0	0	1.0	dB
Frequency Characteristics	Gf	Vin=10MHz / 1MHz , 1.0VppSin-Signal	-1.0	0	1.0	dB
Common Mode Noise Rejection Ratio	CMR	Vin=20KHz, Vin=1Vpp	-	-55	-	dB
Differential Gain	DG	Vin=1.0Vp-p, 10step Video Signal	-	0.3	-	%
Differential Phase	DP	Vin=1.0Vp-p, 10step Video Signal	-	0.4	-	deg

TEST CIRCUIT

When CMR is measured, VGND is connected with VIN.

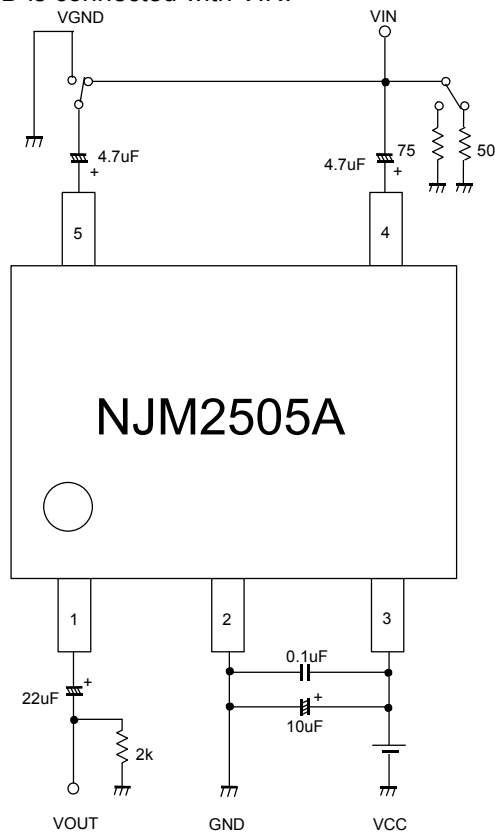

APPLICATION CIRCUIT

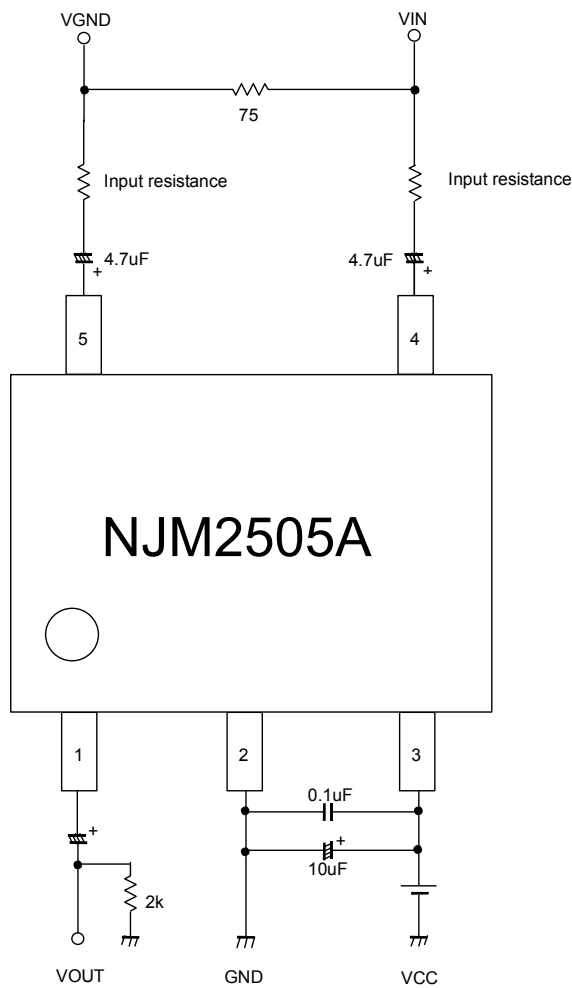

NJM2505A

APPLICATION

1: Please connect input surge resistance to 4pin(Vin) and 5pin(VGND). Please refer to Fig. 1. If resistance is enlarged, a waveform may deteriorate.

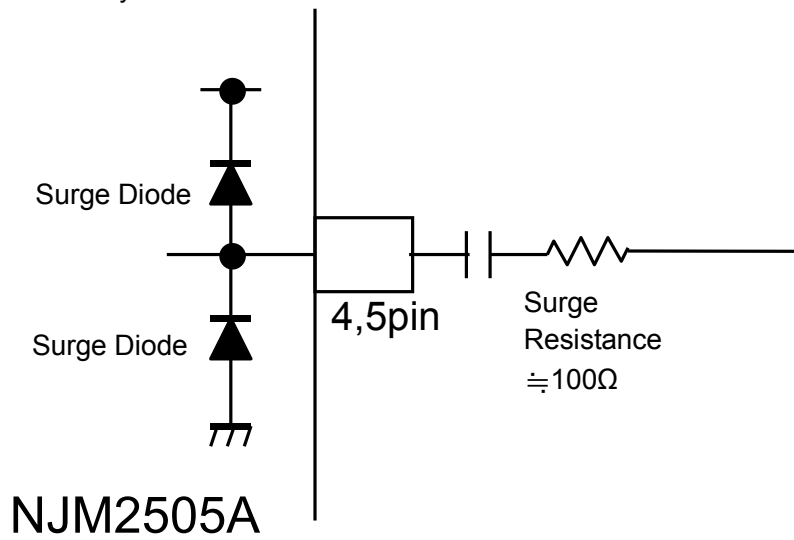

Fig1: External connection

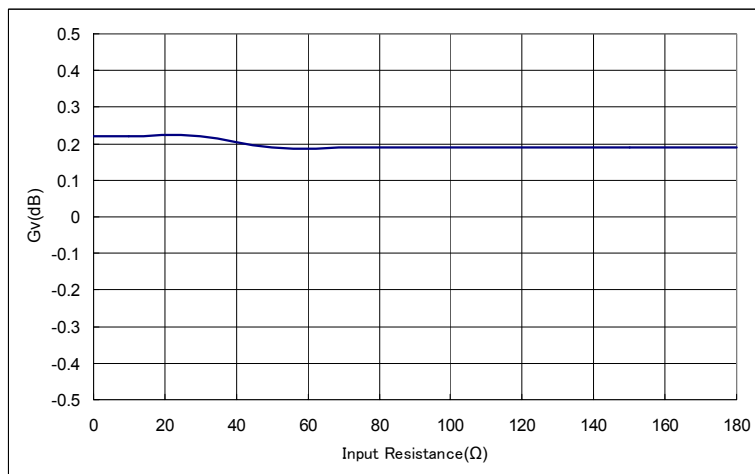

Fig2: Input resistance vs. Voltage gain

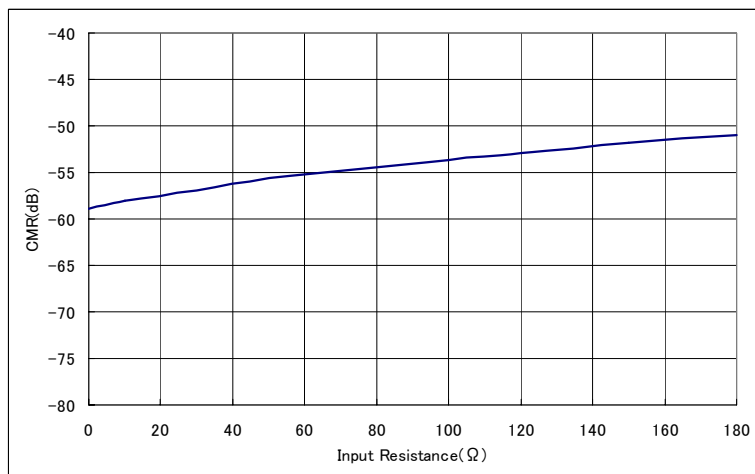

Fig3: Input resistance vs. Common mode rejection ratio

2: Please connect a diode in a VGND at large common mode noise may be inputted into a Vin(4pin) and VGND(5pin). Thereby, large common noise is restricted(refer to Fig.4).Current flows to a diode. Be careful of current capacity.

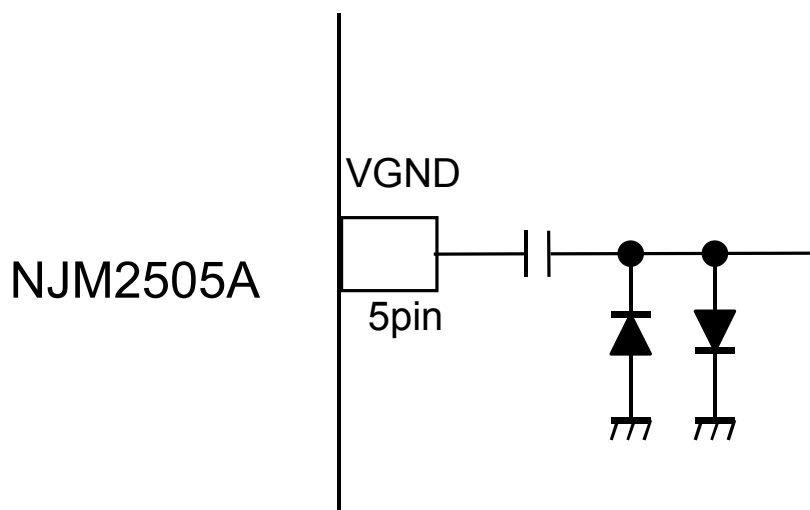

Fig4: External connection

NJM2505A

■ EQUIVALENT CIRCUIT

Pin.No	Symbol	Inside Equivalent Circuit	Voitage
1	Vout		0.92V
2	GND	-	-
3	V ⁺	-	-
4	Vin		1.67V
5	VGND		1.67V

■ TYPICAL CHARACTERISTICS

Voltage gain vs. Frequency
($V_{in}=100\text{kHz}, 1.0\text{Vp-p}, T_a=25^\circ\text{C}$)

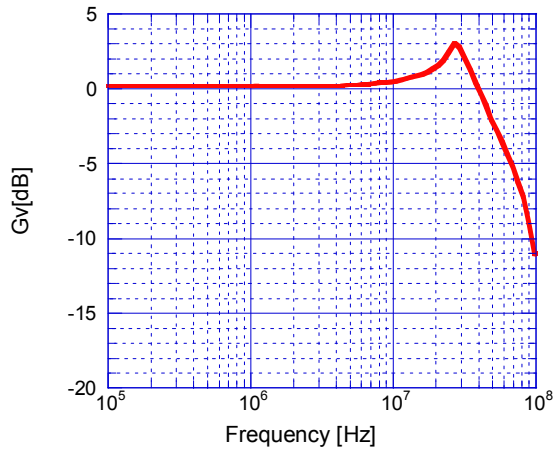

Common mode rejection ratio vs. Frequency
($V_{in}=1.0\text{Vp-p}, T_a=25^\circ\text{C}$)

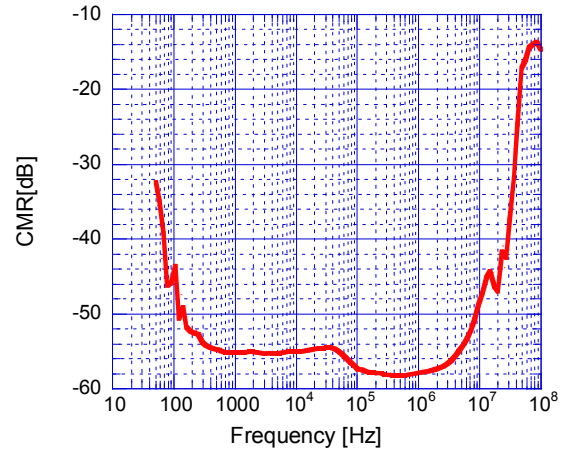

Supply current vs. Supply voltage
($T_a=25^\circ\text{C}$)

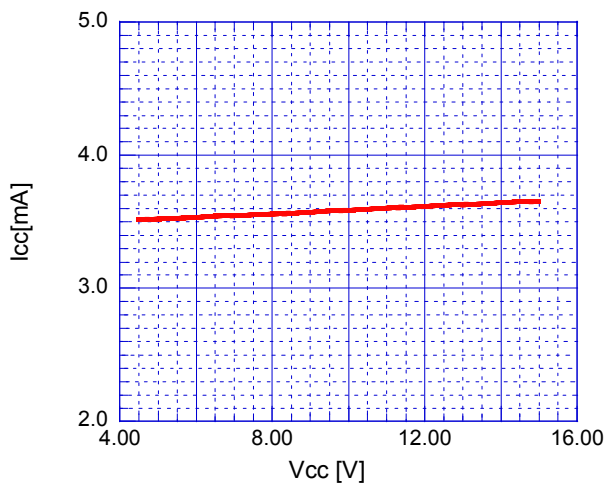

Maximum output voltage vs. Supply voltage
($V_{in}=100\text{kHz}, T_a=25^\circ\text{C}$)

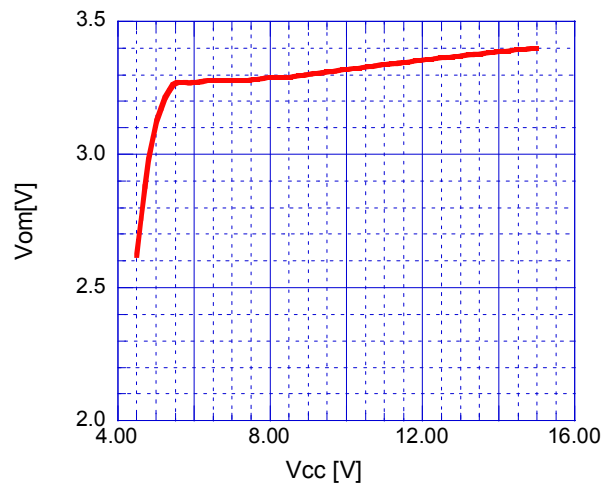

Voltage gain vs. Supply voltage
($V_{in}=100\text{kHz}, 1.0\text{Vpp}, T_a=25^\circ\text{C}$)

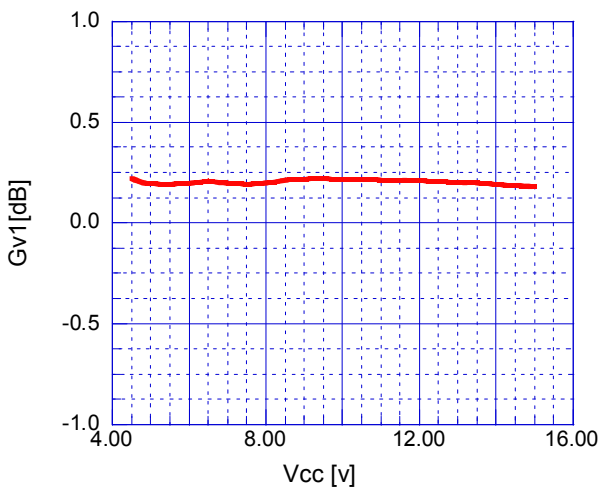

Frequency characteristics vs. Supply voltage
($V_{in}=1.0\text{Vpp}, 10\text{MHz}/1\text{MHz}, T_a=25^\circ\text{C}$)

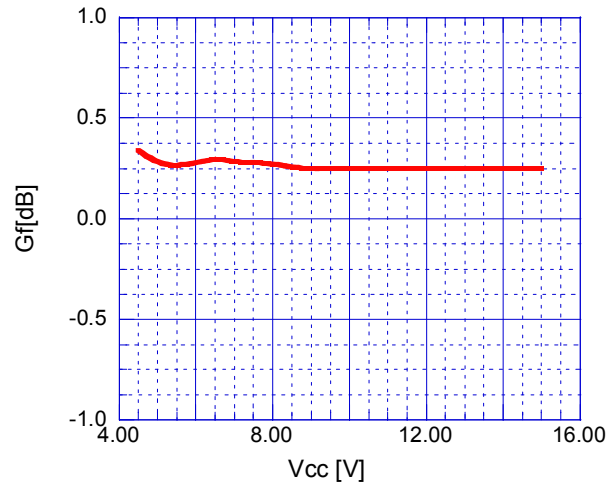

■ TYPICAL CHARACTERISTICS

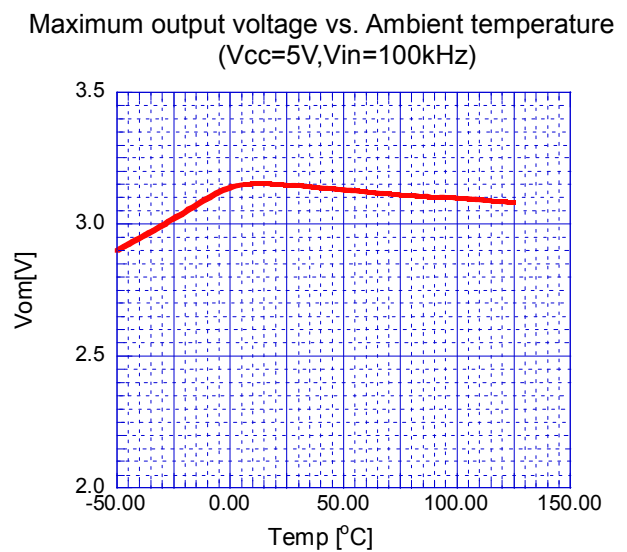
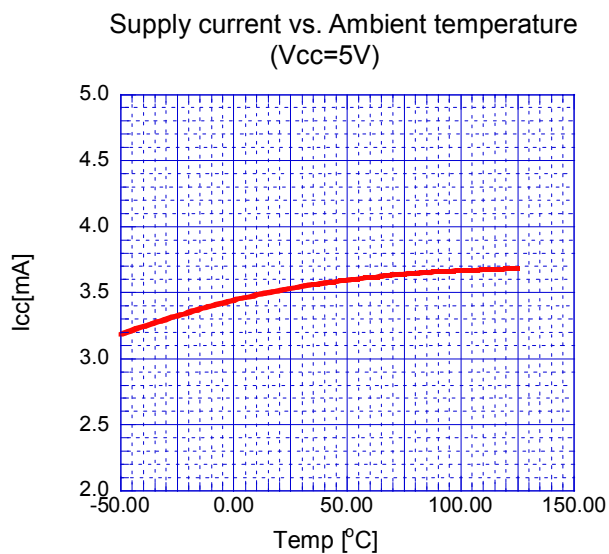
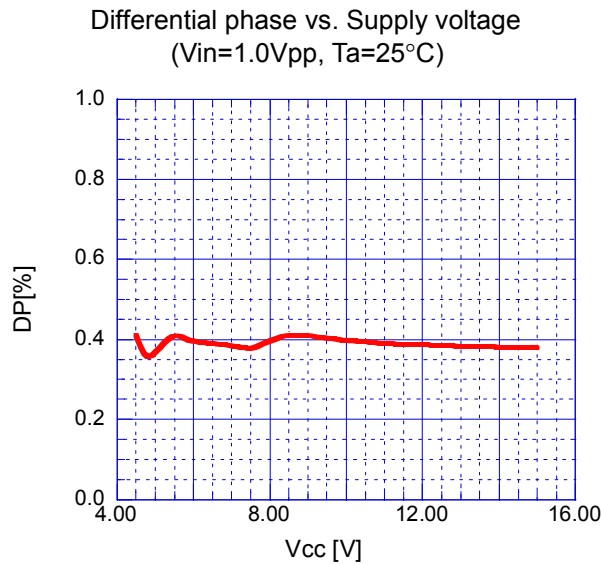
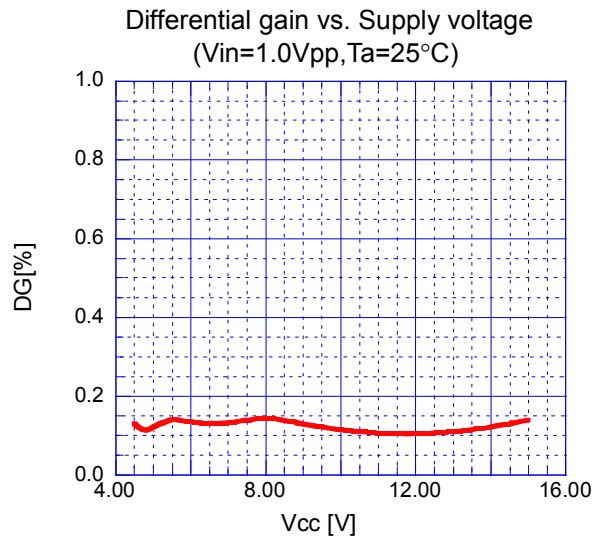
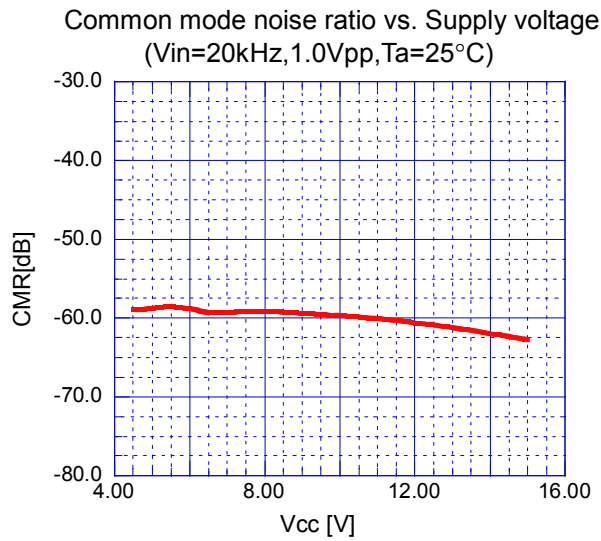

TYPICAL CHARACTERISTICS

Voltage gain vs. Ambient temperature
($V_{cc}=5V, V_{in}=100kHz, 1.0V_{pp}$)

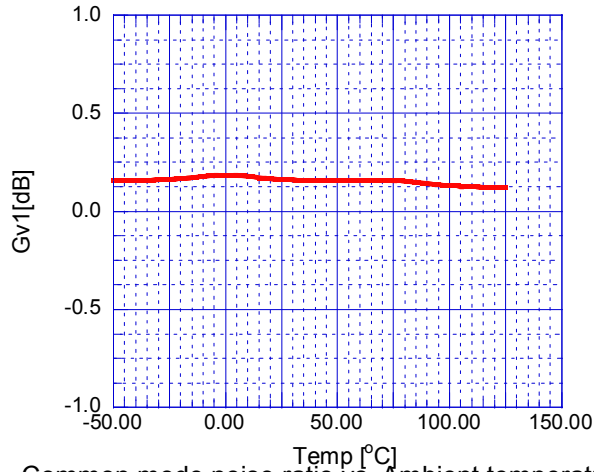

Frequency characteristics vs. Ambient temperature
($V_{cc}=5V, V_{in}=1.0V_{pp}$ 10MHz/1MHz)

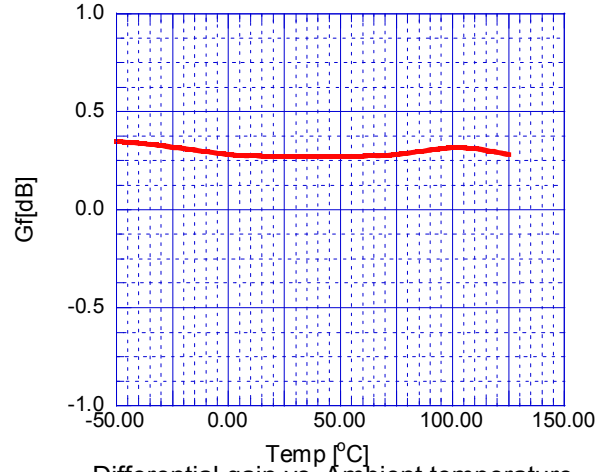

Common mode noise ratio vs. Ambient temperature
($V_{cc}=5V, V_{in}=20kHz, 1.0V_{pp}$)

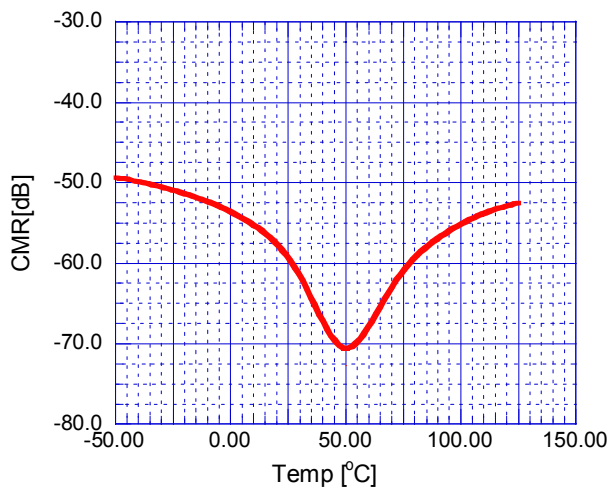

Differential gain vs. Ambient temperature
($V_{cc}=5V, V_{in}=1.0V_{pp}$)

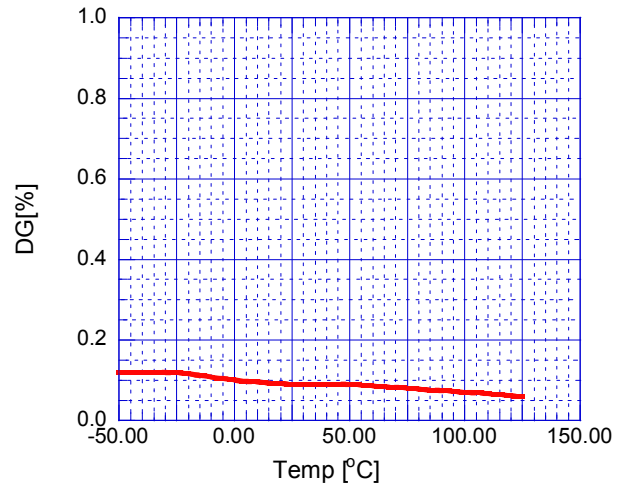

Differential phase vs. Ambient temperature
($V_{cc}=5V, V_{in}=1.0V_{pp}$)

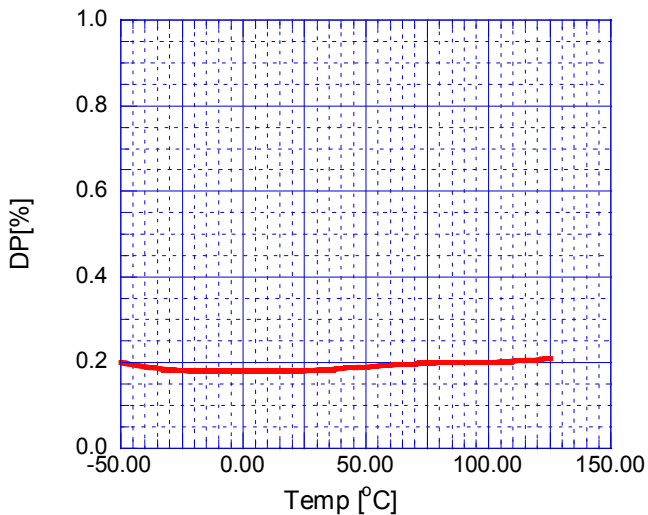

[CAUTION]

The specifications on this databook are only given for information, without any guarantee as regards either mistakes or omissions. The application circuits in this databook are described only to show representative usages of the product and not intended for the guarantee or permission of any right including the industrial rights.



Компания «ЭлектроПласт» предлагает заключение долгосрочных отношений при поставках импортных электронных компонентов на взаимовыгодных условиях!

Наши преимущества:

- Оперативные поставки широкого спектра электронных компонентов отечественного и импортного производства напрямую от производителей и с крупнейших мировых складов;
- Поставка более 17-ти миллионов наименований электронных компонентов;
- Поставка сложных, дефицитных, либо снятых с производства позиций;
- Оперативные сроки поставки под заказ (от 5 рабочих дней);
- Экспресс доставка в любую точку России;
- Техническая поддержка проекта, помощь в подборе аналогов, поставка прототипов;
- Система менеджмента качества сертифицирована по Международному стандарту ISO 9001;
- Лицензия ФСБ на осуществление работ с использованием сведений, составляющих государственную тайну;
- Поставка специализированных компонентов (Xilinx, Altera, Analog Devices, Intersil, Interpoint, Microsemi, Aeroflex, Peregrine, Syfer, Eurofarad, Texas Instrument, Miteq, Cobham, E2V, MA-COM, Hittite, Mini-Circuits, General Dynamics и др.);

Помимо этого, одним из направлений компании «ЭлектроПласт» является направление «Источники питания». Мы предлагаем Вам помощь Конструкторского отдела:

- Подбор оптимального решения, техническое обоснование при выборе компонента;
- Подбор аналогов;
- Консультации по применению компонента;
- Поставка образцов и прототипов;
- Техническая поддержка проекта;
- Защита от снятия компонента с производства.



Как с нами связаться

Телефон: 8 (812) 309 58 32 (многоканальный)

Факс: 8 (812) 320-02-42

Электронная почта: org@eplast1.ru

Адрес: 198099, г. Санкт-Петербург, ул. Калинина, дом 2, корпус 4, литера А.