

FEATURES

- **Clipped Sine Wave Output**
- **Optional Voltage Control for Frequency Tuning [VCTCXO]**
- 7.0mm x 5.0mm Surface Mount Package
- Frequency Range 5 – 52 MHz
- Fundamental Crystal Design
- Operating Voltage, +3.0Vdc, +3.3Vdc or +5.0Vdc
- Overall Frequency Stability ± 4.6 ppm
- Operating Temperature to -40°C to $+85^{\circ}\text{C}$
- Tape & Reel Packaging Standard, EIA-418
- **RoHS/Green Compliant [6/6]**



APPLICATIONS

The Model 588, a quartz based analog TCXO with Clipped Sine output and optional frequency tuning, is suitable for applications requiring Stratum 3 performance such as base stations, Microcells, Femtocells, 1588 and Synchronous Ethernet timing, wireless communications, test and measurement.

ORDERING INFORMATION



* Frequency vs. Temperature Only

1] Only available with temperature range code "C".

**Not all performance combinations and frequencies may be available.
Contact your local CTS Representative or CTS Customer Service for availability.**

ELECTRICAL CHARACTERISTICS

PARAMETER	SYMBOL	CONDITIONS	MIN	TYP	MAX	UNIT
Maximum Supply Voltage	V _{CC}	-	-0.6	-	6.0	V
Maximum Control Voltage	V _C	-	-0.5	-	V _{CC}	V
Storage Temperature	T _{STG}	-	-40	-	+100	°C
Operating Temperature	T _A	-	-20	+25	+70	°C
Order Code 'C'			-40		+85	
Order Code 'I'						
Frequency Range	f ₀	-	5	-	52	MHz
Supply Voltage	V _{CC}	±5%	2.85	3.0	3.15	V
Order Code 'R'			3.14	3.3	3.47	
Order Code 'L'			4.75	5.0	5.25	
Order Code 'S'						
Supply Current	I _{CC}	-	-	-	3.5	mA
Frequency Stability	Δf/f ₀	Reference to f ₀ , Including 20 years aging	-	-	4.60	± ppm
Overall Frequency Stability vs. Initial Calibration		@ +25°C, at time of shipment	-	-	1.00	
vs. Operating Temperature		[Fmax. - Fmin.]/2, over -40°C to +85°C	-	-	0.28	
vs. Supply Voltage		[Fmax. - Fmin.]/2, over -20°C to +70°C	-	-	0.14	
vs. Load		±5% change @ +25°C	-	-	0.40	
vs. Aging		±5% change 20 years @ +40°C	-	-	2.80	
Holdover	Δf/f ₀	[Fmax. - Fmin.]/2, over 24 hours	-	-	0.32	
Control Voltage	V _C	-	0.5	1.5	2.5	V
Frequency Tuning [VCTCXO Only]	-	V _C = 1.5V ±1.0V, monotonic positive		5 - 8		± ppm
V _C Input Impedance	Z _{V_C}	-	100	-	-	kOhm
Output Waveform		AC coupled Clipped Sinewave				
Output Voltage Levels			0.8	-	-	V _{p-p}
Output Load	R _L // C _L	-	10kOhm // 10pF			
Output Duty Cycle	SYM	@ 50% Level	45	-	55	%
Start Up Time	T _S	-	-	-	2	ms
Enable Function						
Enable Input Voltage	V _{IH}	Pin 8 Logic '1', Output Enabled	0.7*V _{CC}	-	-	V
Disable Input Voltage	V _{IL}	Pin 8 Logic '0', Output Disabled [High Imp]	-	-	0.3*V _{CC}	
Phase Noise ¹	-	-				dBc/Hz

Notes:

1. Phase Noise performance may vary based on output frequency. See example plot at 10 MHz below.



TEST CIRCUIT – Clipped Sine Load

* DC-Cut Capacitor: Add 1000pF capacitor between the TCXO output and input of load.



MECHANICAL SPECIFICATIONS

PACKAGE DRAWING



MARKING INFORMATION

1. M588 – CTS Model Series.
 2. ● – Pin 1 identifier.
 3. C – CTS identifier.
 4. D – Date code. See Table II for codes.
 5. xxx – Frequency Code.
- Refer to document 016-1454-0, Frequency Code Tables.

NOTES

1. DO NOT make connections to non-labeled pins or castellations as they may have internal connections used in the manufacturing process.
2. Termination pads (e4); barrier plating is nickel [Ni] with gold [Au] flash plate.
3. Reflow conditions per JEDEC J-STD-020, 260°C maximum.
4. MSL = 1.

SUGGESTED SOLDER PAD GEOMETRY

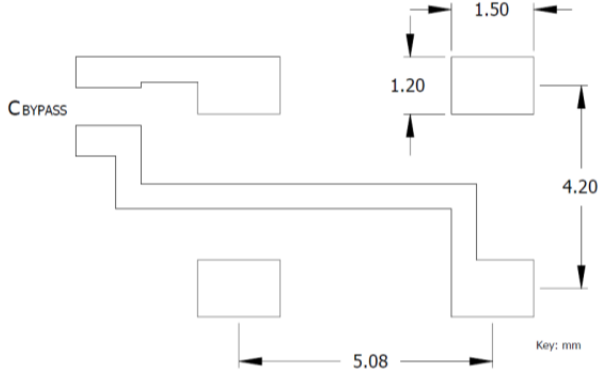

D.U.T. PIN ASSIGNMENTS

PIN	SYMBOL	DESCRIPTION
1	V _C	Control Voltage – VCTCXO [Note 1] GND - TCXO
2	GND	Circuit & Package Ground
3	Output	Clipped Sine Wave Output
4	V _{CC}	Supply Voltage

NOTES

1. Connect to ground for TCXO [no AFC] option.
2. DC-Cut Capacitor Required.
Add 1000pF capacitor between TCXO output and input of load.

TABLE II – DATE CODE

YEAR		MONTH					JAN	FEB	MAR	APR	MAY	JUN	JUL	AUG	SEP	OCT	NOV	DEC
		2001	2005	2009	2013	2017												
2001	2005	2009	2013	2017	A	B	C	D	E	F	G	H	J	K	L	M		
2002	2006	2010	2014	2018	N	P	Q	R	S	T	U	V	W	X	Y	Z		
2003	2007	2011	2015	2019	a	b	c	d	e	f	g	h	j	k	l	m		
2004	2008	2012	2016	2020	n	p	q	r	s	t	u	v	w	x	y	z		

PACKAGING INFORMATION [reference]

Device quantity is 1k pcs. maximum per 180mm reel.

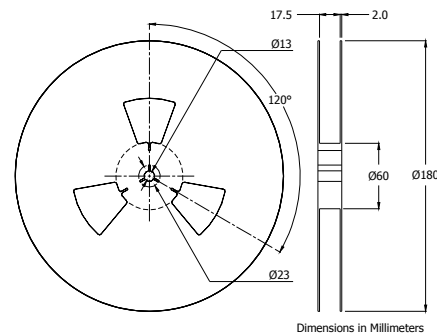
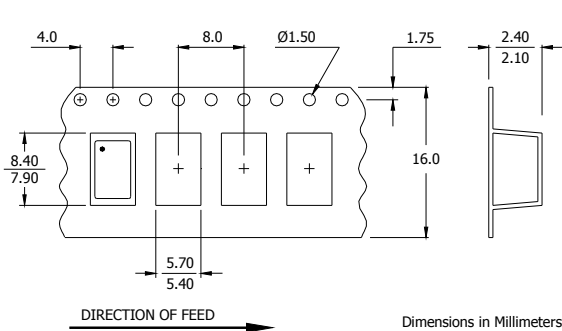



Компания «ЭлектроПласт» предлагает заключение долгосрочных отношений при поставках импортных электронных компонентов на взаимовыгодных условиях!

Наши преимущества:

- Оперативные поставки широкого спектра электронных компонентов отечественного и импортного производства напрямую от производителей и с крупнейших мировых складов;
- Поставка более 17-ти миллионов наименований электронных компонентов;
- Поставка сложных, дефицитных, либо снятых с производства позиций;
- Оперативные сроки поставки под заказ (от 5 рабочих дней);
- Экспресс доставка в любую точку России;
- Техническая поддержка проекта, помощь в подборе аналогов, поставка прототипов;
- Система менеджмента качества сертифицирована по Международному стандарту ISO 9001;
- Лицензия ФСБ на осуществление работ с использованием сведений, составляющих государственную тайну;
- Поставка специализированных компонентов (Xilinx, Altera, Analog Devices, Intersil, Interpoint, Microsemi, Aeroflex, Peregrine, Syfer, Eurofarad, Texas Instrument, Miteq, Cobham, E2V, MA-COM, Hittite, Mini-Circuits, General Dynamics и др.);

Помимо этого, одним из направлений компании «ЭлектроПласт» является направление «Источники питания». Мы предлагаем Вам помощь Конструкторского отдела:

- Подбор оптимального решения, техническое обоснование при выборе компонента;
- Подбор аналогов;
- Консультации по применению компонента;
- Поставка образцов и прототипов;
- Техническая поддержка проекта;
- Защита от снятия компонента с производства.



Как с нами связаться

Телефон: 8 (812) 309 58 32 (многоканальный)

Факс: 8 (812) 320-02-42

Электронная почта: org@eplast1.ru

Адрес: 198099, г. Санкт-Петербург, ул. Калинина, дом 2, корпус 4, литера А.