

BMR456 series Fully regulated Advanced Bus Converters
Input 36-75 V, Output up to 39 A / 468 W

1/28701-FGC 101 1823 revG September 2017

© Flex

Key Features

- Advanced Bus Converter Industry standard Quarter-brick with digital PMBus interface
57.9 x 36.8 x 11.3 mm (2.28 x 1.45 x 0.445 in.)
- Optional industry standard 5-pins for intermediate bus architectures
- Industry-leading Power Density for Telecom and Datacom 127-141W / sq. in
- Flex DC/DC Energy Optimizer built-in
- High efficiency, typ. 96.4% at half load, 12 Vout
- Fully regulated Advanced Bus Converter from 36-75Vin
- 2250 Vdc input to output isolation
- Fast Feed forward regulation to manage line transients
- Optional baseplate for high temperature applications
- Droop Load Sharing option available
- Optional variant supporting output capacitance up to 15mF
- PMBus Revision 1.2 compliant
- 2.9 million hours MTBF
- ISO 9001/14001 certified supplier



Power Management

- Configurable soft start/stop
- Precision delay and ramp-up
- Output voltage margining
- Voltage/current/temperature monitoring
- Configurable output voltage
- Configurable fault response and other parameters
- Power good

Safety Approvals



Design for Environment



Meets requirements in high-temperature lead-free soldering processes.



Contents

Ordering Information	2
General Information	3
Safety Specification	4
Absolute Maximum Ratings	5
Electrical Specification	
9 V, 35 A / 351 W (36-75Vin)	BMR 456 0004/004..... 7
9 V, 39 A / 351 W (36-60Vin)	BMR 456 0000/003..... 11
12 V, 35 A / 420 W (36-75Vin)	BMR 456 0004/001..... 15
12 V, 35 A / 420 W (36-75Vin, high cap load)	BMR 456 0004/018..... 19
12 V, 39 A / 468 W (40-60Vin)	BMR 456 0000/002..... 23
12.45 V, 35 A / 415 W (36-75Vin)	BMR 456 0007/014..... 27
12.45 V, 39 A / 462 W (40-60Vin)	BMR 456 0011/017..... 30
EMC Specification	33
Operating Information	34
Thermal Consideration	38
Connections	39
PMBus Interface	40
Mechanical Information	43
Soldering Information	46
Delivery Information	47
Product Qualification Specification	49

BMR456 series Fully regulated Advanced Bus Converters Input 36-75 V, Output up to 39 A / 468 W

1/28701-FGC 101 1823 revG September 2017

© Flex

Ordering Information

Product program	V _{in}	Output
BMR456 0004/004	36 - 75	9 V / 35 A, 315 W
BMR456 0004/001	36 - 75	12 V / 35 A, 420 W
BMR456 0004/018	36 - 75	12 V / 35 A, 420 W
BMR456 0007/013	36 - 75	12 V / 35 A, 400 W
BMR456 0007/014	36 - 75	12.45 V / 35 A, 415 W
BMR456 0000/003	36 - 60	9 V / 39 A, 351 W
BMR456 0000/002	40 - 60	12 V / 39 A, 468 W
BMR456 0011/016	40 - 60	12 V / 39 A, 445 W
BMR456 0011/017	40 - 60	12.45 V / 39 A, 462 W

Product Number and Packaging

BMR456	n ₁	n ₂	n ₃	n ₄	/	n ₅	n ₆	n ₇	n ₈
Mechanical pin option	x				/				
Mechanical option		x			/				
Hardware option			x	x	/				
Configuration file					/	x	x	x	
Packaging(optional)					/				x

Optional designation Description

n ₁	0 = Standard pin length 5.33 mm(0.210 in.) 1 = Surface mount option ^{note 1} 2 = Lead length 3.69 mm(0.145 in.) (cut) 3 = Lead length 4.57 mm(0.180 in.) (cut) 4 = Lead length 2.79 mm(0.110 in.) (cut)
n ₂	0 = Open frame 1 = Baseplate 2 = Baseplate with GND-pin
n ₃ n ₄	00 = 40-60 V _{in} , 4-13.2 V _{out} adjusted, with digital interface 01 = 40-60 V _{in} , 4-13.2 V _{out} adjusted, without digital interface 04 = 36-75 V _{in} , 4-13.2 V _{out} adjusted, with digital interface 05 = 36-75 V _{in} , 4-13.2 V _{out} adjusted, without digital interface 06 = 36-75 V _{in} , 4-13.2 V _{out} adjusted, Droop load sharing function for parallel operation, without digital interface 07 = 36-75 V _{in} , 4-13.2 V _{out} adjusted, Droop load sharing function for parallel operation, with digital interface 11 = 40-60 V _{in} , 4-13.2 V _{out} adjusted, Droop load sharing function for parallel operation, with digital interface 12 = 40-60 V _{in} , 4-13.2 V _{out} adjusted, Droop

	load sharing function for parallel operation, without digital interface
n ₅ n ₆ n ₇	001 = 12 V Standard configuration for 36-75 V _{in} , n ₃ n ₄ = 04 or 05 002 = 12 V Standard configuration for 40-60 V _{in} , n ₃ n ₄ = 00 or 01 003 = 9 V Standard configuration for 36-60 V _{in} , n ₃ n ₄ = 00 or 01 004 = 9 V Standard configuration for 36-75 V _{in} , n ₃ n ₄ = 04 or 05 008 = 12 V with positive RC logic configuration for 36-75 V _{in} , n ₃ n ₄ = 04 or 05 009 = 12 V with positive RC logic configuration for 40-60 V _{in} , n ₃ n ₄ = 00 or 01 013 = 12 V with 0.6 V droop load sharing function configuration (36-75 V _{in} , n ₃ n ₄ = 06 or 07) 014 = 12.45 V with 0.6V droop load sharing function configuration (36-75 V _{in} , n ₃ n ₄ = 06 or 07) 016 = 12 V with 0.6 V droop load sharing function configuration (40-60 V _{in} , n ₃ n ₄ = 11 or 12) 017 = 12.45 V with 0.6V droop load sharing function configuration (40-60 V _{in} , n ₃ n ₄ = 11 or 12) 018 = 12 V Standard configuration for maximum 15mF capacitive load, 36-75 V _{in} , n ₃ n ₄ = 04 or 05 xxx = Application Specific Configuration
n ₈	Blank = 20 converters(through hole pin)/tray, 3 trays/ box, PE foam dissipative Blank = 10 converters(surface mount pin)/tray, 2 trays/box, Antistatic PPE E = Through hole pin-in-paste product with dry package, 12 converters(through hole pin)/tray, 4 trays/ box, Antistatic Polystyrene

Example: Product number BMR4562100/001 equals an Through hole mount lead length 3.69 mm (cut), baseplate, digital interface with 12 V standard configuration variant with PE foam tray package.
Product number BMR4563104/004E equals an Through hole mount lead length 4.57 mm (cut), baseplate, digital interface with 9 V standard configuration variant with Antistatic Polystyrene dry package.

Note 1: No baseplate option

For application specific configurations contact your local Flex sales representative.

BMR456 series Fully regulated Advanced Bus Converters
Input 36-75 V, Output up to 39 A / 468 W

1/28701-FGC 101 1823 revG September 2017

© Flex

General Information

Reliability

The failure rate (λ) and mean time between failures (MTBF = $1/\lambda$) is calculated at max output power and an operating ambient temperature (T_A) of +40°C. Flex uses Telcordia SR-332 Issue 2 Method 1 to calculate the mean steady-state failure rate and standard deviation (σ).

Telcordia SR-332 Issue 2 also provides techniques to estimate the upper confidence levels of failure rates based on the mean and standard deviation.

Mean steady-state failure rate, λ	Std. deviation, σ
425 nFailures/h	60.9 nFailures/h

MTBF (mean value) for the BMR456 series = 2.9 Mh.

MTBF at 90% confidence level = 2.4 Mh

Compatibility with RoHS requirements

The products are compatible with the relevant clauses and requirements of the RoHS directive 2011/65/EU and have a maximum concentration value of 0.1% by weight in homogeneous materials for lead, mercury, hexavalent chromium, PBB and PBDE and of 0.01% by weight in homogeneous materials for cadmium.

Exemptions in the RoHS directive utilized in Flex products are found in the Statement of Compliance document.

Flex fulfills and will continuously fulfill all its obligations under regulation (EC) No 1907/2006 concerning the registration, evaluation, authorization and restriction of chemicals (REACH) as they enter into force and is through product materials declarations preparing for the obligations to communicate information on substances in the products.

Quality Statement

The products are designed and manufactured in an industrial environment where quality systems and methods like ISO 9000, Six Sigma, and SPC are intensively in use to boost the continuous improvements strategy. Infant mortality or early failures in the products are screened out and they are subjected to an ATE-based final test. Conservative design rules, design reviews and product qualifications, plus the high competence of an engaged work force, contribute to the high quality of the products.

Warranty

Warranty period and conditions are defined in Flex General Terms and Conditions of Sale.

Limitation of Liability

Flex does not make any other warranties, expressed or implied including any warranty of merchantability or fitness for a particular purpose (including, but not limited to, use in life support applications, where malfunctions of product can

cause injury to a person's health or life).

© Flex 2017

The information and specifications in this technical specification is believed to be correct at the time of publication. However, no liability is accepted for inaccuracies, printing errors or for any consequences thereof. Flex reserves the right to change the contents of this technical specification at any time without prior notice.

BMR456 series Fully regulated Advanced Bus Converters Input 36-75 V, Output up to 39 A / 468 W	1/28701-FGC 101 1823 revG September 2017
	© Flex

Safety Specification**General information**

Flex DC/DC converters and DC/DC regulators are designed in accordance with the safety standards IEC 60950-1, EN 60950-1 and UL 60950-1 *Safety of Information Technology Equipment*.

IEC/EN/UL 60950-1 contains requirements to prevent injury or damage due to the following hazards:

- Electrical shock
- Energy hazards
- Fire
- Mechanical and heat hazards
- Radiation hazards
- Chemical hazards

On-board DC/DC converters and DC/DC regulators are defined as component power supplies. As components they cannot fully comply with the provisions of any safety requirements without “conditions of acceptability”.

Clearance between conductors and between conductive parts of the component power supply and conductors on the board in the final product must meet the applicable safety requirements. Certain conditions of acceptability apply for component power supplies with limited stand-off (see Mechanical Information for further information). It is the responsibility of the installer to ensure that the final product housing these components complies with the requirements of all applicable safety standards and regulations for the final product.

Component power supplies for general use should comply with the requirements in IEC/EN/UL 60950-1 *Safety of Information Technology Equipment*. Product related standards, e.g. IEEE 802.3af *Power over Ethernet*, and ETS-300132-2 *Power interface at the input to telecom equipment, operated by direct current (dc)* are based on IEC/EN/UL 60950-1 with regards to safety.

Flex DC/DC converters and DC/DC regulators are UL 60950-1 recognized and certified in accordance with EN 60950-1. The flammability rating for all construction parts of the products meet requirements for V-0 class material according to IEC 60695-11-10, *Fire hazard testing, test flames – 50 W horizontal and vertical flame test methods*.

Isolated DC/DC converters

Galvanic isolation between input and output is verified in an electric strength test and the isolation voltage (V_{iso}) meets the voltage strength requirement for basic insulation according to IEC/EN/UL 60950-1.

It is recommended to use a slow blow fuse at the input of each DC/DC converter. If an input filter is used in the circuit the fuse should be placed in front of the input filter. In the rare event of a component problem that imposes a short

circuit on the input source, this fuse will provide the following functions:

- Isolate the fault from the input power source so as not to affect the operation of other parts of the system
- Protect the distribution wiring from excessive current and power loss thus preventing hazardous overheating

The DC/DC converter output is considered as safety extra low voltage (SELV) if one of the following conditions is met:

- The input source has double or reinforced insulation from the AC mains according to IEC/EN/UL 60950-1
- The input source has basic or supplementary insulation from the AC mains and the input of the DC/DC converter is maximum 60 Vdc and connected to protective earth according to IEC/EN/UL 60950-1
- The input source has basic or supplementary insulation from the AC mains and the DC/DC converter output is connected to protective earth according to IEC/EN/UL 60950-1

BMR456 series Fully regulated Advanced Bus Converters
 Input 36-75 V, Output up to 39 A / 468 W

1/28701-FGC 101 1823 revG September 2017

© Flex

Absolute Maximum Ratings

Characteristics		min	typ	max	Unit
T_{P1}	Operating Temperature (see Thermal Consideration section)	-40		+125	°C
T_s	Storage temperature	-55		+125	°C
V_i	Input voltage	-0.5		+80 +65*	V
C_{out}	Output capacitance	100			µF
V_{iso}	Isolation voltage (input to output test voltage)			2250	Vdc
V_{iso}	Isolation voltage (input to baseplate qualification test voltage)			750	Vdc
V_{iso}	Isolation voltage (baseplate to output qualification test voltage)			750	Vdc
V_{tr}	Input voltage transient according to ETSI EN 300 132-2 and Telcordia GR-1089-CORE			+100 +80*	V
V_{RC}	Remote Control pin voltage	-0.3		18	V
V Logic I/O	SALERT, CTRL, SCL, SDA, SA0, SA1	-0.3		3.6	V

Stress in excess of Absolute Maximum Ratings may cause permanent damage. Absolute Maximum Ratings, sometimes referred to as no destruction limits, are normally tested with one parameter at a time exceeding the limits of Output data or Electrical Characteristics. If exposed to stress above these limits, function and performance may degrade in an unspecified manner.

*) Apply for the narrow input version $V_i = 40-60$ V

Fundamental Circuit Diagram

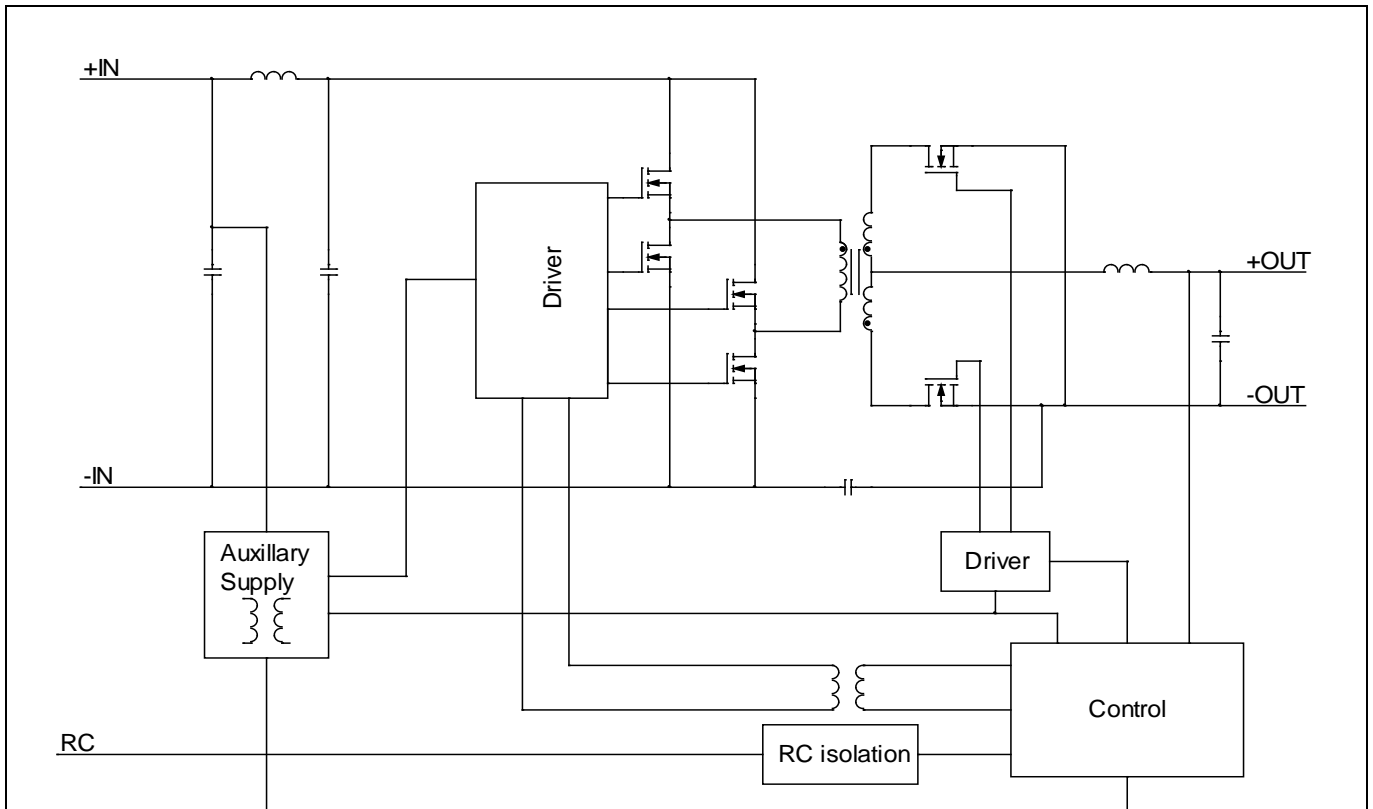

BMR456 series Fully regulated Advanced Bus Converters
 Input 36-75 V, Output up to 39 A / 468 W

1/28701-FGC 101 1823 revG September 2017
 © Flex

Functional Description

$T_{P1}, T_{P3} = -40$ to $+90^{\circ}\text{C}$, $V_I = 36$ to 75 V, sense pins connected to output pins unless otherwise specified under Conditions.
 Typical values given at: $T_{P1}, T_{P3} = +25^{\circ}\text{C}$, $V_I = 53$ V, max I_O , unless otherwise specified under Conditions.

Characteristics		Conditions	min	typ	max	Unit
PMBus monitoring accuracy						
VIN_READ	Input voltage		-2	± 0.2	2	%
VOUT_READ	Output voltage	$V_I = 53$ V	-1.0	± 0.1	1.0	%
IOUT_READ	Output current	$V_I = 53$ V, 50-100% of max I_O	-6	± 1.5	6	%
IOUT_READ	Output current	$V_I = 53$ V, 10% of max I_O	-0.6	-	0.6	A
TEMP_READ	Temperature		-5	± 3.5	5	$^{\circ}\text{C}$
Fault Protection Characteristics						
Input Under Voltage Lockout, UVLO	Factory default		-	33	-	V
	Setpoint accuracy		-2	-	2	%
	Hysteresis	Factory default	-	2	-	V
		Configurable via PMBus of threshold range, Note 1	0	-	-	V
Delay		-	300	-	μs	
(Output voltage) Over/Under Voltage Protection, OVP/UVF	VOUT_UV_FAULT_LIMIT	Factory default	-	0	-	V
		Configurable via PMBus, Note 1	0	-	16	V
	VOUT_OV_FAULT_LIMIT	Factory default	-	15.6	-	V
		Configurable via PMBus, Note 1	V_{OUT}	-	16	V
fault response time		-	200	-	μs	
Over Current Protection, OCP	Setpoint accuracy	I_O	-6	-	6	%
	IOUT_OC_FAULT_LIMIT	Factory default	-	41	-	A
		Configurable via PMBus, Note 1	0	-	100	A
fault response time		-	200	-	μs	
Over Temperature Protection, OTP	OTP_FAULT_LIMIT	Factory default	-	125	-	$^{\circ}\text{C}$
		Configurable via PMBus, Note 1	-50	-	125	
	OTP hysteresis	Factory default	-	10	-	
		Configurable via PMBus, Note 1	0	-	125	
fault response time		-	300	-	μs	
Logic Input/Output Characteristics						
Logic input low (V_{IL})	CTRL, SA0, SA1, PG, SCL, SDA,		-	-	1.1	V
Logic input high (V_{IH})			2.1	-	-	V
Logic output low (V_{OL})	CTRL, PG, SALERT, SCL, SDA $I_{OL} = 6$ mA		-	-	0.25	V
Logic output high (V_{OH})	CTRL, PG, SALERT, SCL, SDA $I_{OH} = -6$ mA		2.7	-	-	V
Bus free time T(BUF)	Note 2		1.3	-	-	μs

Note 1: See Operating Information section.

Note 2: PMBus timing parameters according to PMBus spec.

BMR456 series Fully regulated Advanced Bus Converters
 Input 36-75 V, Output up to 39 A / 468 W

1/28701-FGC 101 1823 revG September 2017

© Flex

9.0 V, 35 A / 315 W Electrical Specification
BMR 456 0004/004
 $T_{P1}, T_{P3} = -40$ to $+90^{\circ}\text{C}$, $V_I = 36$ to 75 V, sense pins connected to output pins unless otherwise specified under Conditions.

 Typical values given at: $T_{P1}, T_{P3} = +25^{\circ}\text{C}$, $V_I = 53$ V, max I_O , unless otherwise specified under Conditions.

 Additional $C_{in} = 0.1$ mF, $C_{out} = 3.5$ mF.

Characteristics		Conditions	min	typ	max	Unit
V_I	Input voltage range		36		75	V
V_{loff}	Turn-off input voltage	Decreasing input voltage	32	33	34	V
V_{lon}	Turn-on input voltage	Increasing input voltage	34	35	36	V
C_I	Internal input capacitance			18		μF
P_O	Output power		0		315	W
η	Efficiency	50% of max I_O		95.1		%
		max I_O		94.3		
		50% of max I_O , $V_I = 48$ V		95.3		
		max I_O , $V_I = 48$ V		94.3		
P_d	Power Dissipation	max I_O		19.0	26.4	W
P_{li}	Input idling power	$I_O = 0$ A, $V_I = 53$ V		3.1		W
P_{RC}	Input standby power	$V_I = 53$ V (turned off with RC)		0.4		W
f_s	Default switching frequency	0-100% of max I_O	133	140	147	kHz

V_{Oi}	Output voltage initial setting and accuracy	$T_{P1} = +25^{\circ}\text{C}$, $V_I = 53$ V, $I_O = 35$ A	8.91	9.0	9.09	V
V_O	Output adjust range	See operating information	4.0		13.2	V
	Output voltage tolerance band	0-100% of max I_O	8.82		9.18	V
	Line regulation	max I_O		8	24	mV
	Load regulation	$V_I = 53$ V, 1-100% of max I_O		25	40	mV
V_{tr}	Load transient voltage deviation	$V_I = 53$ V, Load step 25-75-25% of max I_O , $di/dt = 1$ A/ μs		± 0.4		V
t_{tr}	Load transient recovery time			150		μs
t_r	Ramp-up time (from 10-90% of V_{Oi})	10-100% of max I_O , $T_{P1} = 25^{\circ}\text{C}$, $V_I = 53$ V		8		ms
t_s	Start-up time (from V_I connection to 90% of V_{Oi})			24		ms
t_f	Vin shutdown fall time (from V_I off to 10% of V_O)	max I_O , $I_O = 0$ A, $C_O = 0$ mF		4.5		ms
				7		s
t_{RC}	RC start-up time	max I_O		12		ms
	RC shutdown fall time (from RC off to 10% of V_O)	max I_O		4.5		ms
		$I_O = 0$ A, $C_O = 0$ mF			7	
I_O	Output current		0		35	A
I_{lim}	Current limit threshold	$V_O = 8.1$ V, $T_{P1}, T_{P3} < \max T_{P1}, T_{P3}$	38	41	44	A
I_{sc}	Short circuit current	$T_{P1} = 25^{\circ}\text{C}$, see Note 1		8		A
C_{out}	Recommended Capacitive Load	$T_{P1} = 25^{\circ}\text{C}$, see Note 2	0.1	3.5	6	mF
V_{Oac}	Output ripple & noise	See ripple & noise section, max I_O , see Note 3		50	110	mVp-p
OVP	Over voltage protection	$T_{P1}, T_{P3} = 25^{\circ}\text{C}$, $V_I = 53$ V, 10-100% of max I_O		11.7		V
RC	Sink current, see Note 4	See operating information			0.7	mA
	Trigger level	Decreasing / Increasing RC-voltage		2.6 / 2.9		V

Note 1: OCP in hic-up mode, RMS value.

Note 2: Low ESR-value

 Note 3: $C_{out} = 100$ μF , external capacitance

Note 4: Sink current drawn by external device connected to the RC pin. Minimum sink current required guaranteeing activated RC function.

BMR456 series Fully regulated Advanced Bus Converters
 Input 36-75 V, Output up to 39 A / 468 W

1/28701-FGC 101 1823 revG September 2017

© Flex

Typical Characteristics

BMR 456 0004/004

9.0 V, 35 A / 315 W

Efficiency

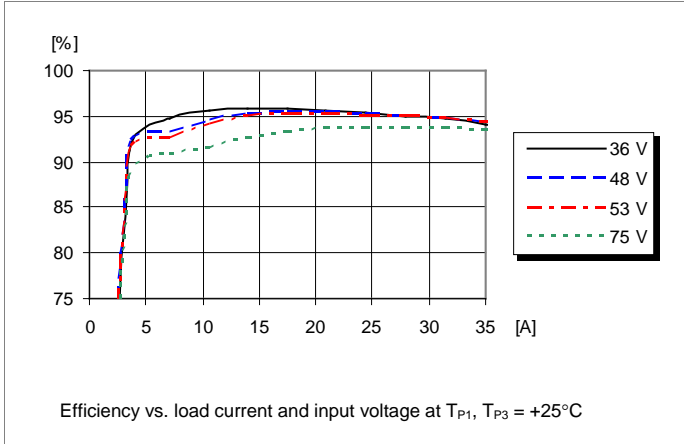

Power Dissipation

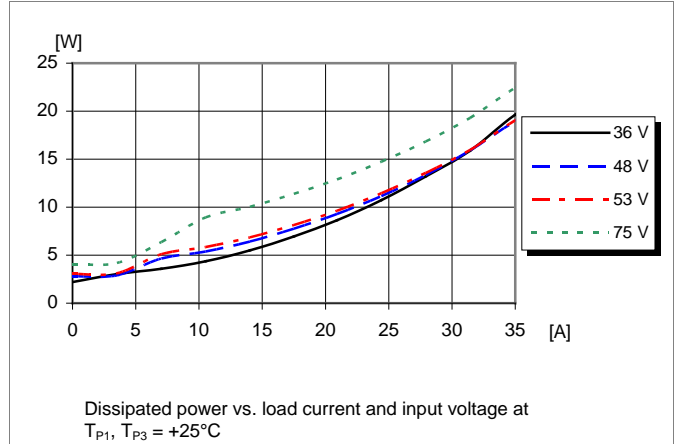

Output Characteristics

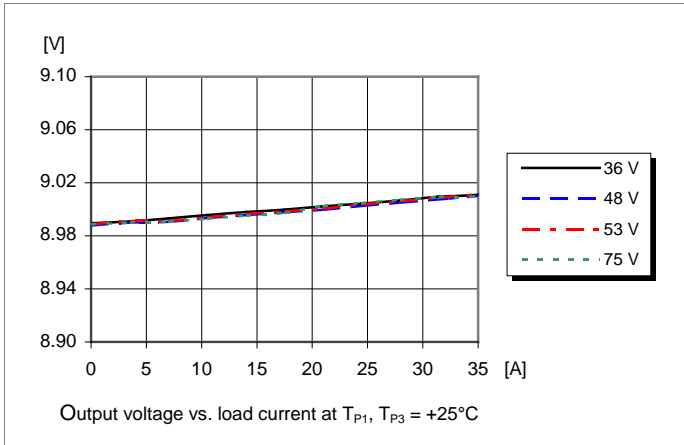

Current Limit Characteristics

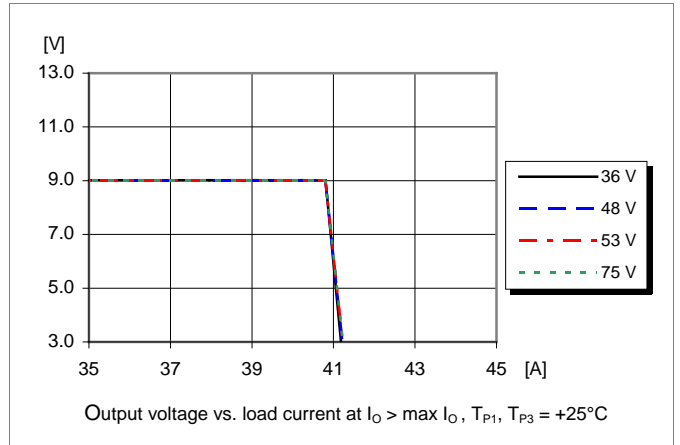

BMR456 series Fully regulated Advanced Bus Converters
 Input 36-75 V, Output up to 39 A / 468 W

1/28701-FGC 101 1823 revG September 2017

© Flex

Typical Characteristics

BMR 456 0004/004

9.0 V, 35 A / 315 W

Start-up

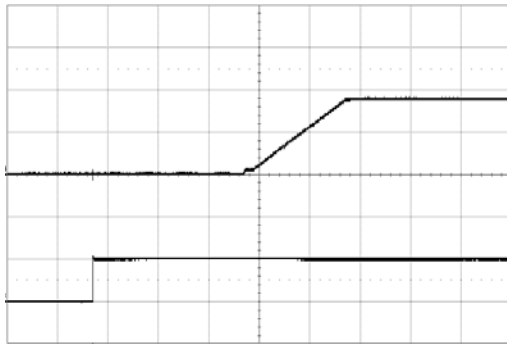

Start-up enabled by connecting V_I at:
 $T_{P1}, T_{P3} = +25^\circ\text{C}$, $V_I = 53\text{ V}$,
 $I_O = 35\text{ A}$ resistive load.

Top trace: output voltage (5 V/div.).
 Bottom trace: input voltage (50 V/div.).
 Time scale: (5 ms/div.).

Shut-down



Shut-down enabled by disconnecting V_I at:
 $T_{P1}, T_{P3} = +25^\circ\text{C}$, $V_I = 53\text{ V}$,
 $I_O = 35\text{ A}$ resistive load.

Top trace: output voltage (5 V/div.).
 Bottom trace: input voltage (50 V/div.).
 Time scale: (2 ms/div.).

Output Ripple & Noise

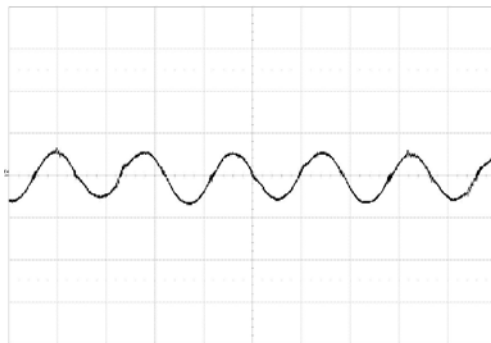

Output voltage ripple at:
 $T_{P1}, T_{P3} = +25^\circ\text{C}$, $V_I = 53\text{ V}$,
 $I_O = 35\text{ A}$ resistive load.

Trace: output voltage (50 mV/div.).
 Time scale: (2 μs/div.).

Output Load Transient Response

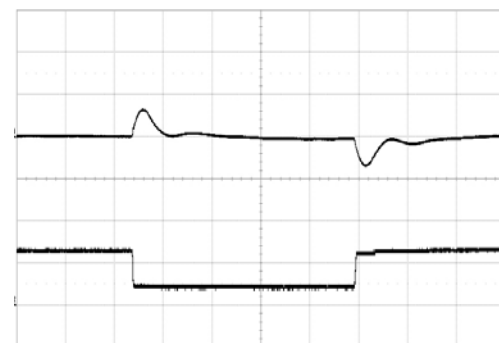

Output voltage response to load current
 step-change (8.75-26.25-8.75 A) at:
 $T_{P1}, T_{P3} = +25^\circ\text{C}$, $V_I = 53\text{ V}$, $C_O = 3.5\text{ mF}$.

Top trace: output voltage (0.2 V/div.).
 Bottom trace: output current (20 A/div.).
 Time scale: (0.5 ms/div.).

Input Voltage Transient Response

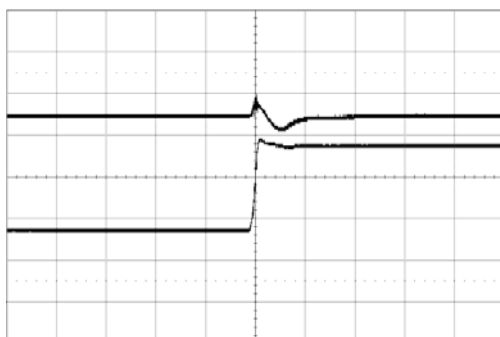

Output voltage response to input voltage
 transient at: $T_{P1}, T_{P3} = +25^\circ\text{C}$, $V_I = 36\text{-}75\text{ V}$,
 $I_O = 35\text{ A}$ resistive load, $C_O = 3.5\text{ mF}$

Top trace: output voltage (2 V/div.).
 Bottom trace: input voltage (20 V/div.).
 Time scale: (0.5 ms/div.).

BMR456 series Fully regulated Advanced Bus Converters
 Input 36-75 V, Output up to 39 A / 468 W

1/28701-FGC 101 1823 revG September 2017

© Flex

Typical Characteristics

BMR 456 0004/004

9.0 V, 35 A / 315 W

Output Current Derating – Open frame

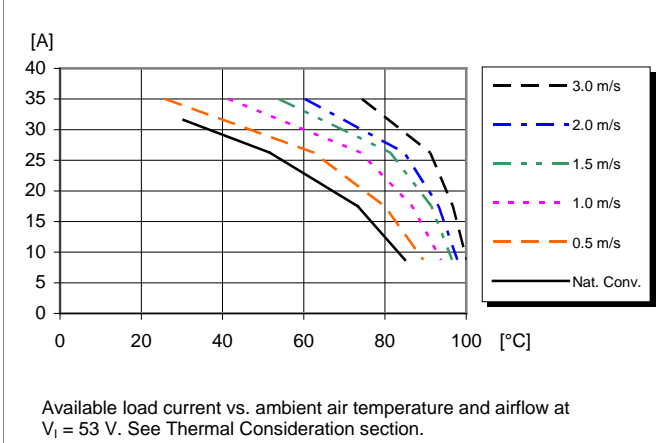

Output Current Derating – Base plate

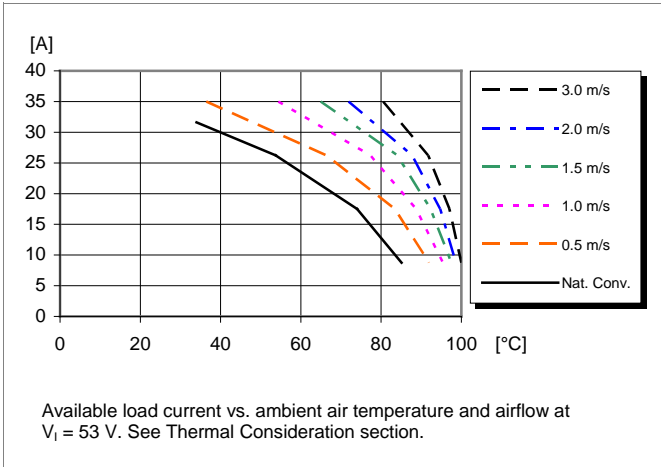

Thermal Resistance – Base plate

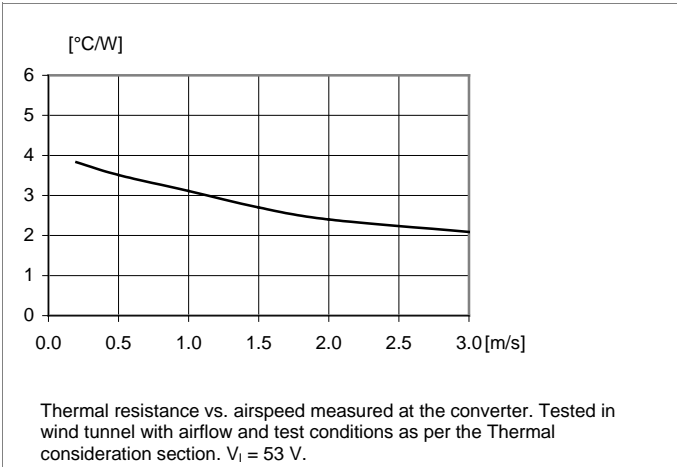

Output Current Derating – Base plate + Heat sink

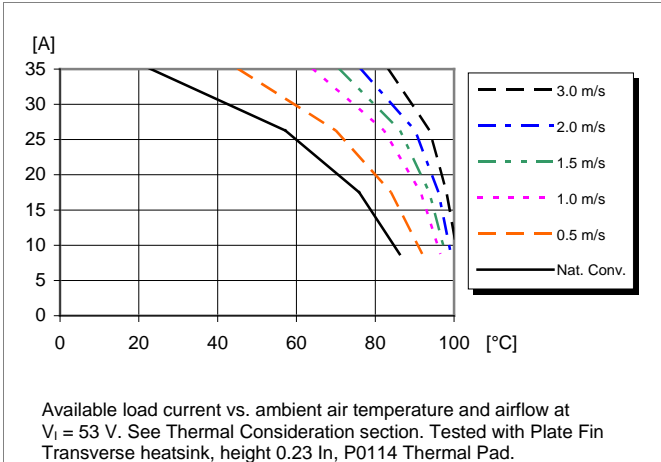

Output Current Derating – Cold wall sealed box

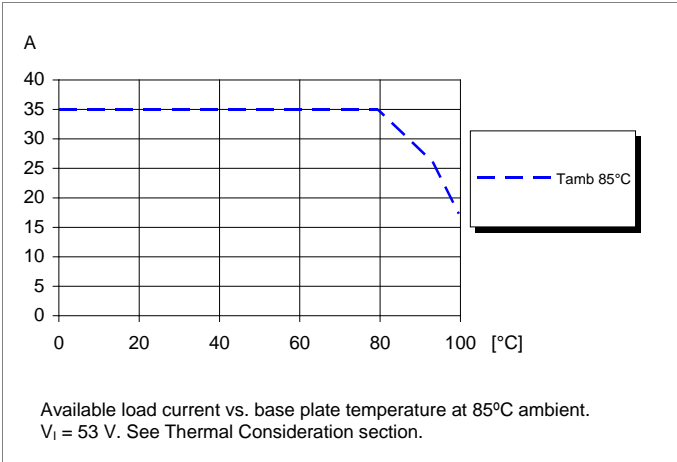

BMR456 series Fully regulated Advanced Bus Converters
 Input 36-75 V, Output up to 39 A / 468 W

1/28701-FGC 101 1823 revG September 2017

© Flex

9.0 V, 39 A / 351 W Electrical Specification
BMR 456 0000/003
 $T_{P1}, T_{P3} = -40$ to $+90^{\circ}\text{C}$, $V_I = 36$ to 60 V, sense pins connected to output pins unless otherwise specified under Conditions.

 Typical values given at: $T_{P1}, T_{P3} = +25^{\circ}\text{C}$, $V_I = 53$ V, max I_O , unless otherwise specified under Conditions.

 Additional $C_{in} = 0.1$ mF, $C_{out} = 3.9$ mF.

Characteristics		Conditions	min	typ	max	Unit
V_I	Input voltage range		36		60	V
V_{loff}	Turn-off input voltage	Decreasing input voltage	32	33	34	V
V_{lon}	Turn-on input voltage	Increasing input voltage	34	35	36	V
C_I	Internal input capacitance			18		μF
P_O	Output power		0		351	W
η	Efficiency	50% of max I_O		95.9		%
		max I_O		94.7		
		50% of max I_O , $V_I = 48$ V		95.9		
		max I_O , $V_I = 48$ V		94.7		
P_d	Power Dissipation	max I_O		19.6	28.5	W
P_{li}	Input idling power	$I_O = 0$ A, $V_I = 53$ V		2.4		W
P_{RC}	Input standby power	$V_I = 53$ V (turned off with RC)		0.4		W
f_s	Default switching frequency	0-100% of max I_O	133	140	147	kHz

V_{Oi}	Output voltage initial setting and accuracy	$T_{P1} = +25^{\circ}\text{C}$, $V_I = 53$ V, $I_O = 39$ A	8.92	9.0	9.08	V
V_O	Output adjust range	See operating information	4.0		13.2	V
	Output voltage tolerance band	0-100% of max I_O	8.82		9.18	V
	Line regulation	max I_O		8	24	mV
	Load regulation	$V_I = 53$ V, 1-100% of max I_O		4	23	mV
V_{tr}	Load transient voltage deviation	$V_I = 53$ V, Load step 25-75-25% of max I_O , $di/dt = 1$ A/ μs		± 0.4		V
t_{tr}	Load transient recovery time			150		μs
t_r	Ramp-up time (from 10-90% of V_{Oi})	10-100% of max I_O , $T_{P1} = 25^{\circ}\text{C}$, $V_I = 53$ V		8		ms
t_s	Start-up time (from V_I connection to 90% of V_{Oi})			24		ms
t_f	Vin shutdown fall time (from V_I off to 10% of V_O)	max I_O		3		ms
		$I_O = 0$ A, $C_O = 0$ mF		7		s
t_{RC}	RC start-up time	max I_O		12		ms
	RC shutdown fall time (from RC off to 10% of V_O)	max I_O		4.5		ms
		$I_O = 0$ A, $C_O = 0$ mF			7	
I_O	Output current		0		39	A
I_{lim}	Current limit threshold	$V_O = 8.1$ V, $T_{P1}, T_{P3} < \max T_{P1}, T_{P3}$	41	44	47	A
I_{sc}	Short circuit current	$T_{P1} = 25^{\circ}\text{C}$, see Note 1		14		A
C_{out}	Recommended Capacitive Load	$T_{P1} = 25^{\circ}\text{C}$, see Note 2	2.2	3.9	6	mF
V_{Oac}	Output ripple & noise	See ripple & noise section, max I_O , see Note 3		50	110	mVp-p
OVP	Over voltage protection	$T_{P1}, T_{P3} = 25^{\circ}\text{C}$, $V_I = 53$ V, 10-100% of max I_O		11.7		V
RC	Sink current, see Note 4	See operating information			0.7	mA
	Trigger level	Decreasing / Increasing RC-voltage		2.6 / 2.9		V

Note 1: OCP in hic-up mode

Note 2: Low ESR-value

 Note 3: $C_{out} = 100$ μF , external capacitance

Note 4: Sink current drawn by external device connected to the RC pin. Minimum sink current required guaranteeing activated RC function.

BMR456 series Fully regulated Advanced Bus Converters
 Input 36-75 V, Output up to 39 A / 468 W

1/28701-FGC 101 1823 revG September 2017

© Flex

Typical Characteristics

BMR 456 0000/003

9.0 V, 39 A / 351 W

Efficiency

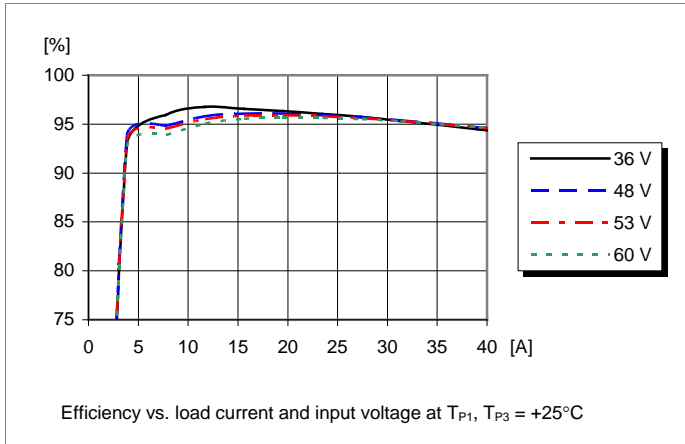

Power Dissipation

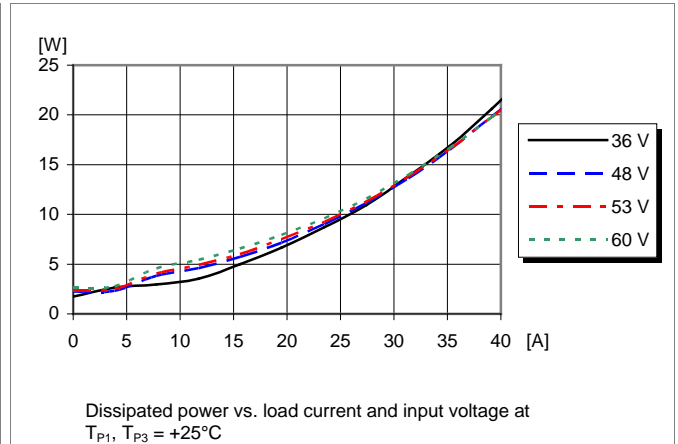

Output Characteristics

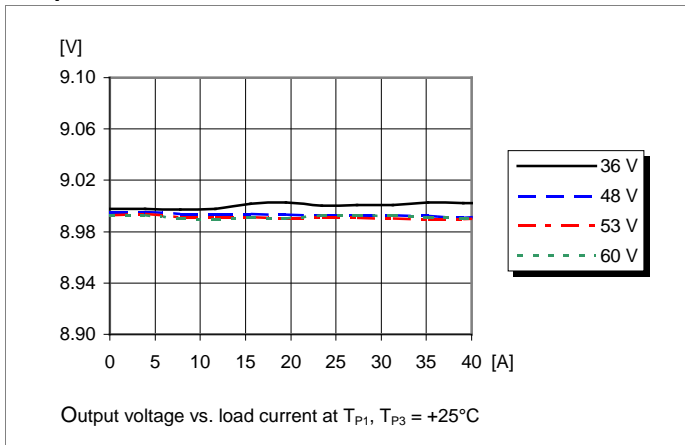

Current Limit Characteristics

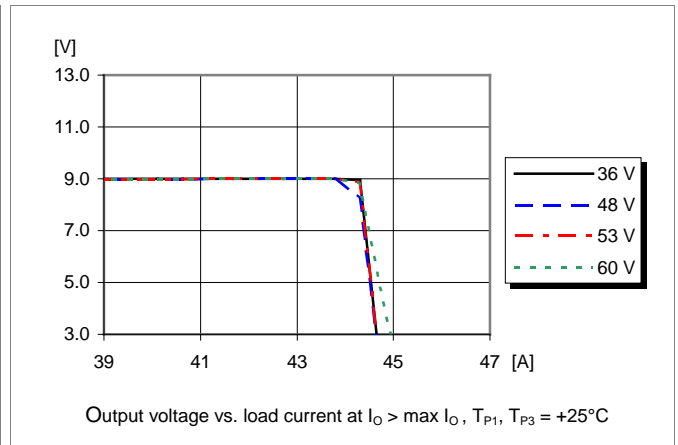

BMR456 series Fully regulated Advanced Bus Converters
 Input 36-75 V, Output up to 39 A / 468 W

1/28701-FGC 101 1823 revG September 2017

© Flex

Typical Characteristics

BMR 456 0000/003

9.0 V, 39 A / 351 W

Start-up



Shut-down



Output Ripple & Noise

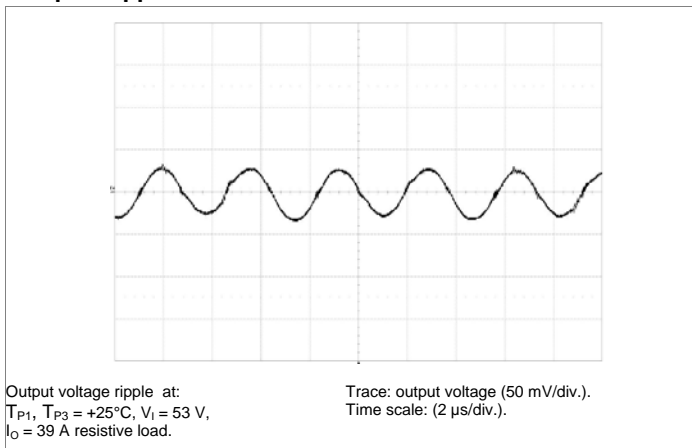

Output Load Transient Response

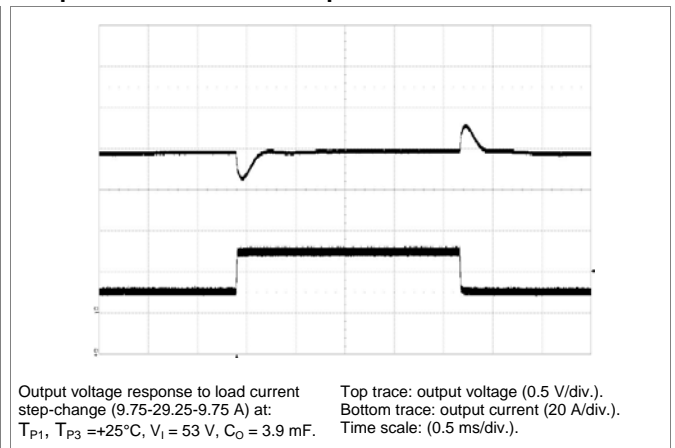

Input Voltage Transient Response

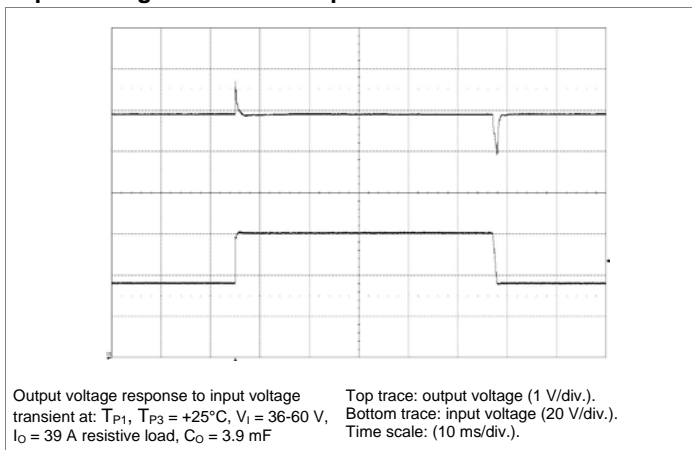

BMR456 series Fully regulated Advanced Bus Converters
 Input 36-75 V, Output up to 39 A / 468 W

1/28701-FGC 101 1823 revG September 2017

© Flex

Typical Characteristics

BMR 456 0000/003

9.0 V, 39 A / 351 W

Output Current Derating – Open frame



Output Current Derating – Base plate

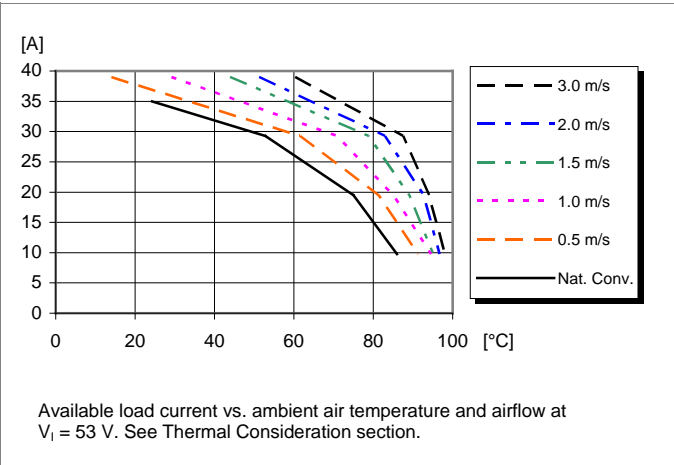

Thermal Resistance – Base plate

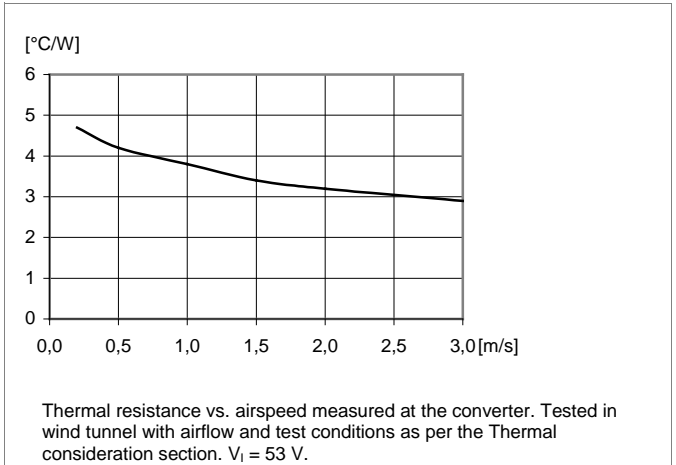

Output Current Derating – Cold wall sealed box

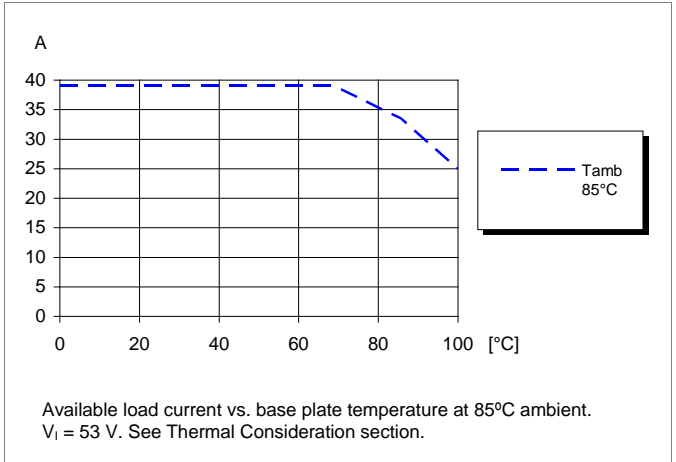

BMR456 series Fully regulated Advanced Bus Converters
 Input 36-75 V, Output up to 39 A / 468 W

1/28701-FGC 101 1823 revG September 2017

© Flex

12.0 V, 35 A / 420 W Electrical Specification
BMR 456 0004/001
 $T_{P1}, T_{P3} = -40$ to $+90^{\circ}\text{C}$, $V_I = 36$ to 75 V, sense pins connected to output pins unless otherwise specified under Conditions.

 Typical values given at: $T_{P1}, T_{P3} = +25^{\circ}\text{C}$, $V_I = 53$ V, max I_O , unless otherwise specified under Conditions.

 Additional $C_{in} = 0.1$ mF, $C_{out} = 3.5$ mF.

Characteristics		Conditions	min	typ	max	Unit
V_I	Input voltage range		36		75	V
V_{loff}	Turn-off input voltage	Decreasing input voltage	32	33	34	V
V_{lon}	Turn-on input voltage	Increasing input voltage	34	35	36	V
C_I	Internal input capacitance			18		μF
P_O	Output power		0		420	W
η	Efficiency	50% of max I_O		96.2		%
		max I_O		95.5		
		50% of max I_O , $V_I = 48$ V		96.4		
		max I_O , $V_I = 48$ V		95.5		
P_d	Power Dissipation	max I_O		19.8	29.5	W
P_{li}	Input idling power	$I_O = 0$ A, $V_I = 53$ V		3.3		W
P_{RC}	Input standby power	$V_I = 53$ V (turned off with RC)		0.4		W
f_s	Default switching frequency	0-100% of max I_O	133	140	147	kHz

V_{Oi}	Output voltage initial setting and accuracy	$T_{P1} = 25^{\circ}\text{C}$, $V_I = 53$ V, $I_O = 35$ A	11.88	12.0	12.12	V
V_O	Output adjust range	See operating information	4.0		13.2	V
	Output voltage tolerance band	0-100% of max I_O	11.76		12.24	V
	Line regulation	max I_O		21	55	mV
	Load regulation	$V_I = 53$ V, 0-100% of max I_O		6	40	mV
V_{tr}	Load transient voltage deviation	$V_I = 53$ V, Load step 25-75-25% of max I_O , $di/dt = 1$ A/ μs		± 0.4		V
t_{tr}	Load transient recovery time			150		μs
t_r	Ramp-up time (from 10-90% of V_{Oi})	10-100% of max I_O , $T_{P1}, T_{P3} = 25^{\circ}\text{C}$, $V_I = 53$ V		8		ms
t_s	Start-up time (from V_I connection to 90% of V_{Oi})			24		ms
t_f	Vin shutdown fall time (from V_I off to 10% of V_O)	max I_O		3.6		ms
		$I_O = 0$ A, $C_O = 0$ mF		7		s
t_{RC}	RC start-up time	max I_O		12		ms
	RC shutdown fall time (from RC off to 10% of V_O)	max I_O		5.1		ms
		$I_O = 0$ A, $C_O = 0$ mF		7		s
I_O	Output current		0		35	A
I_{lim}	Current limit threshold	$V_O = 10.8$ V, $T_{P1}, T_{P3} < \max T_{P1}, T_{P3}$	37	41	44	A
I_{sc}	Short circuit current	$T_{P1}, T_{P3} = 25^{\circ}\text{C}$, see Note 1		12		A
C_{out}	Recommended Capacitive Load	$T_{P1}, T_{P3} = 25^{\circ}\text{C}$, see Note 2	0.1	3.5	6	mF
V_{Oac}	Output ripple & noise	See ripple & noise section, max I_O , see Note 3		60	150	mVp-p
OVP	Over voltage protection	$T_{P1}, T_{P3} = 25^{\circ}\text{C}$, $V_I = 53$ V, 10-100% of max I_O		15.6		V
RC	Sink current, see Note 4	See operating information			0.7	mA
	Trigger level	Decreasing / Increasing RC-voltage		2.6 / 2.9		V

Note 1: OCP in hic-up mode

Note 2: Low ESR-value

 Note 3: $C_{out} = 100$ μF , external capacitance

Note 4: Sink current drawn by external device connected to the RC pin. Minimum sink current required guaranteeing activated RC function.

BMR456 series Fully regulated Advanced Bus Converters
 Input 36-75 V, Output up to 39 A / 468 W

1/28701-FGC 101 1823 revG September 2017

© Flex

Typical Characteristics
12.0 V, 35 A / 420 W

BMR 456 0004/001

Efficiency

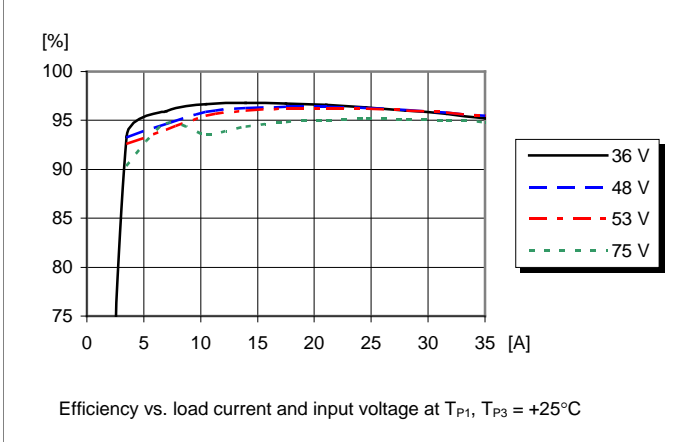

Power Dissipation

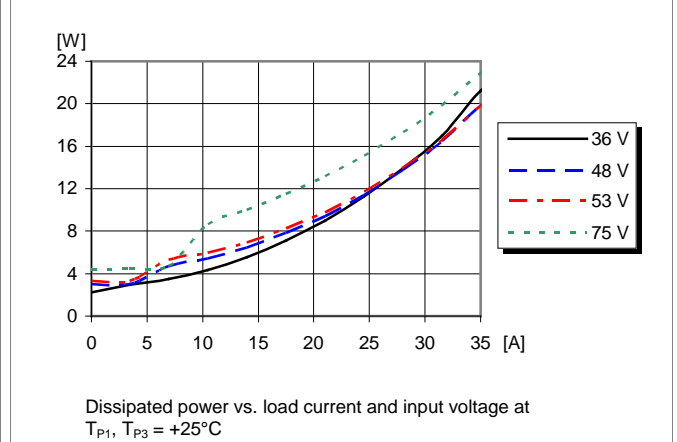

Output Characteristics

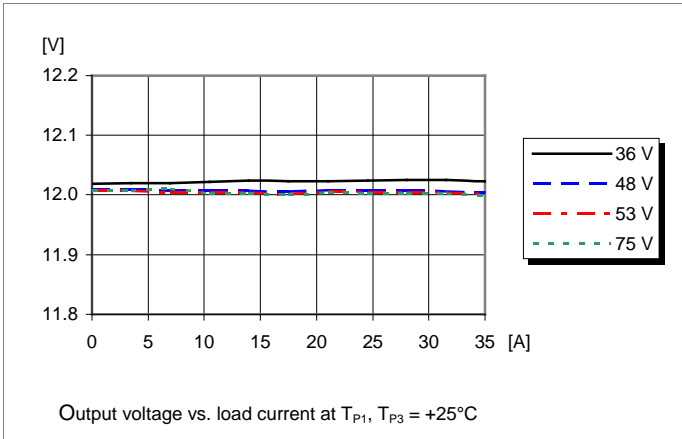

Current Limit Characteristics

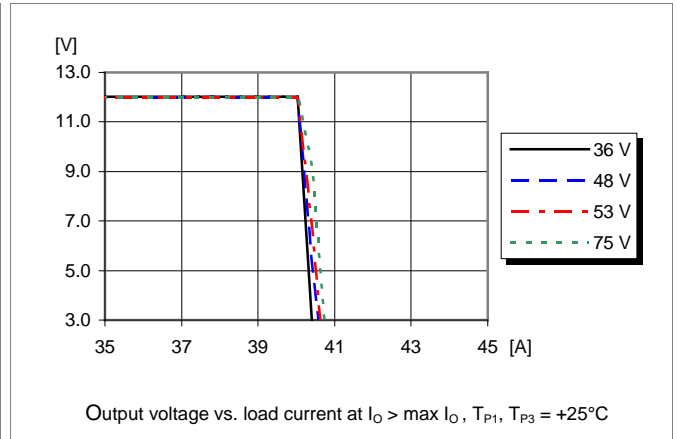

BMR456 series Fully regulated Advanced Bus Converters
 Input 36-75 V, Output up to 39 A / 468 W

1/28701-FGC 101 1823 revG September 2017

© Flex

Typical Characteristics

BMR 456 0004/001

12.0 V, 35 A / 420 W

Start-up

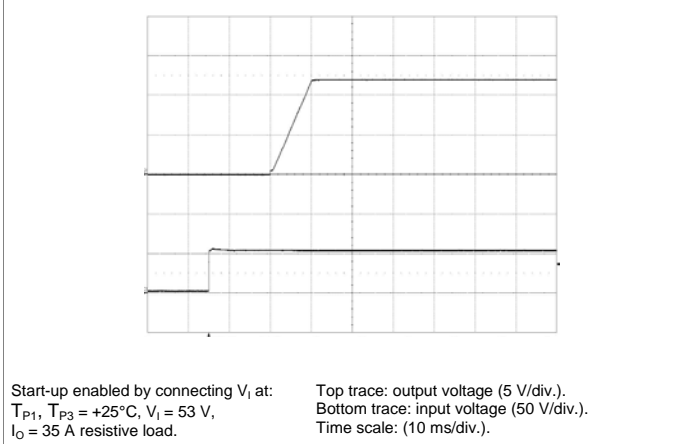

Shut-down

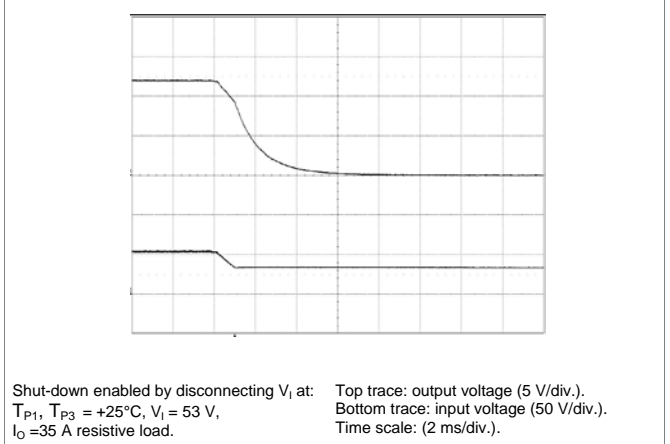

Output Ripple & Noise

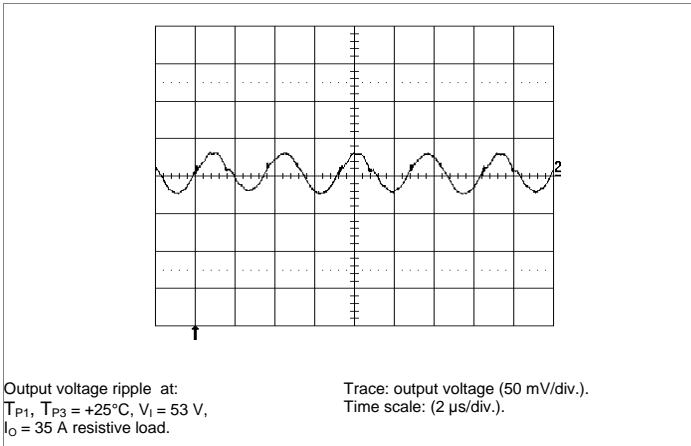

Output Load Transient Response

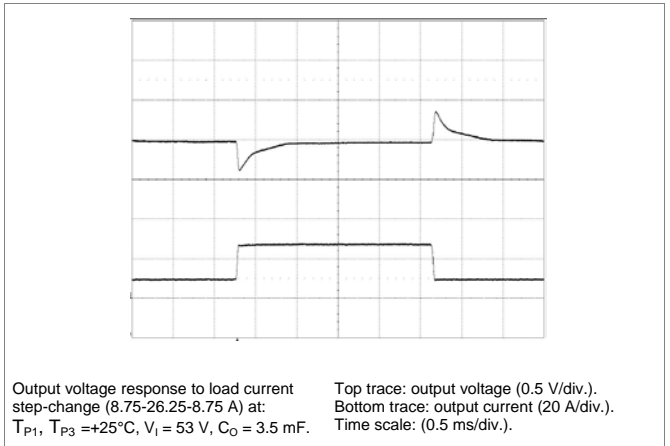

Input Voltage Transient Response

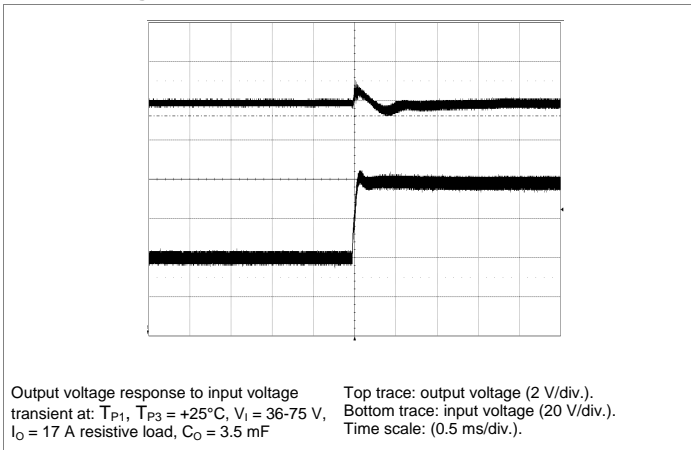

BMR456 series Fully regulated Advanced Bus Converters
 Input 36-75 V, Output up to 39 A / 468 W

1/28701-FGC 101 1823 revG September 2017

© Flex

Typical Characteristics 12.0 V, 35 A / 420 W

BMR 456 0004/001

Output Current Derating – Open frame

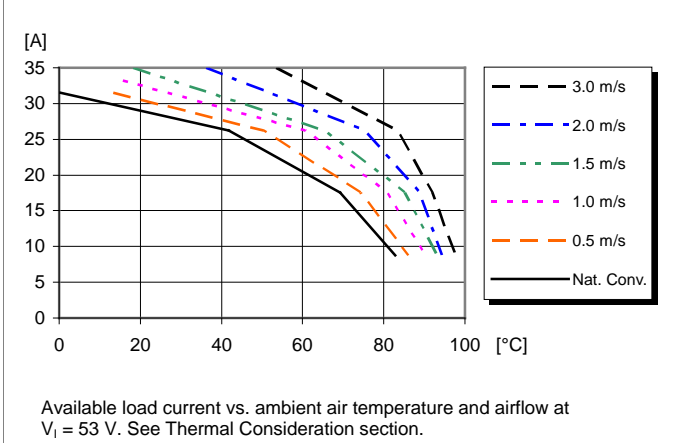

Output Current Derating – Base plate

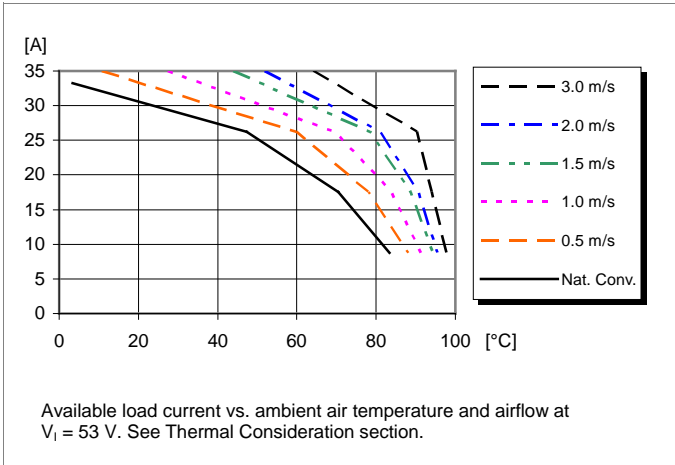

Thermal Resistance – Base plate

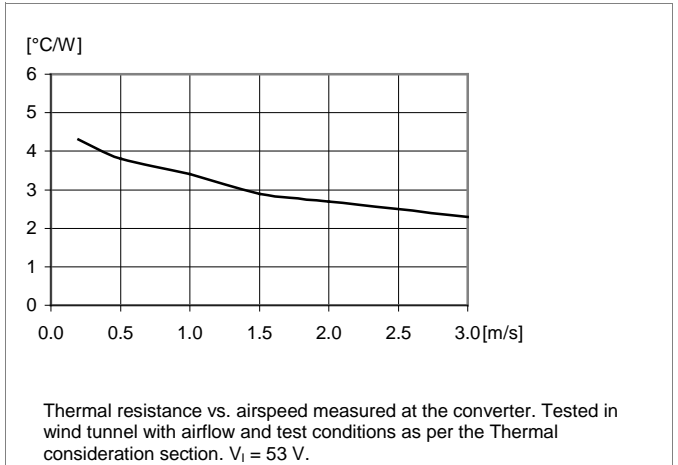

Output Current Derating – Base plate + Heat sink

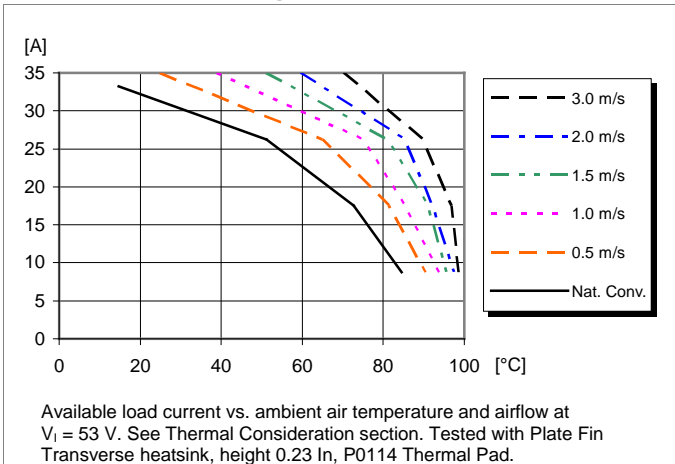

Output Current Derating – Cold wall sealed box

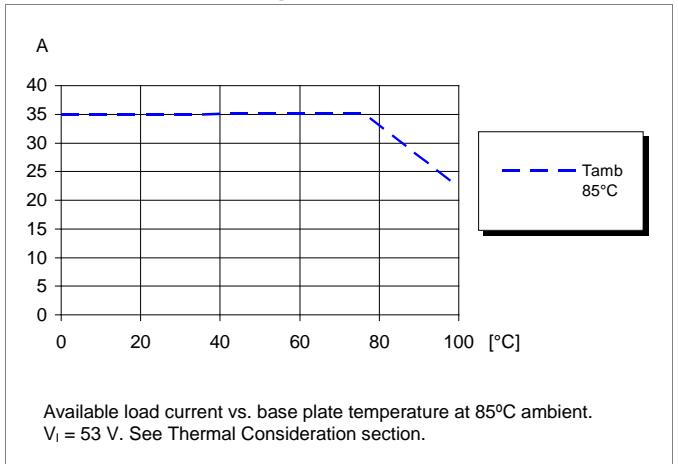

BMR456 series Fully regulated Advanced Bus Converters
 Input 36-75 V, Output up to 39 A / 468 W

1/28701-FGC 101 1823 revG September 2017

© Flex

12.0 V, 35 A / 420 W Electrical Specification
BMR 456 0004/018
 $T_{P1}, T_{P3} = -40$ to $+90^{\circ}\text{C}$, $V_I = 36$ to 75 V, sense pins connected to output pins unless otherwise specified under Conditions.

 Typical values given at: $T_{P1}, T_{P3} = +25^{\circ}\text{C}$, $V_I = 53$ V, max I_O , unless otherwise specified under Conditions.

 Additional $C_{in} = 0.1$ mF, $C_{out} = 3.5$ mF.

Characteristics		Conditions	min	typ	max	Unit
V_I	Input voltage range		36		75	V
V_{loff}	Turn-off input voltage	Decreasing input voltage	32	33	34	V
V_{lon}	Turn-on input voltage	Increasing input voltage	34	35	36	V
C_I	Internal input capacitance			18		μF
P_O	Output power		0		420	W
η	Efficiency	50% of max I_O		96.2		%
		max I_O		95.5		
		50% of max I_O , $V_I = 48$ V		96.4		
		max I_O , $V_I = 48$ V		95.5		
P_d	Power Dissipation	max I_O		19.8	29.5	W
P_{li}	Input idling power	$I_O = 0$ A, $V_I = 53$ V		3.3		W
P_{RC}	Input standby power	$V_I = 53$ V (turned off with RC)		0.4		W
f_s	Default switching frequency	0-100% of max I_O	133	140	147	kHz

V_{Oi}	Output voltage initial setting and accuracy	$T_{P1} = 25^{\circ}\text{C}$, $V_I = 53$ V, $I_O = 35$ A	11.88	12.0	12.12	V
V_O	Output adjust range	See operating information	4.0		13.2	V
	Output voltage tolerance band	0-100% of max I_O	11.76		12.24	V
	Line regulation	max I_O		21	55	mV
	Load regulation	$V_I = 53$ V, 0-100% of max I_O		6	40	mV
V_{tr}	Load transient voltage deviation	$V_I = 53$ V, Load step 25-75-25% of max I_O , $di/dt = 1$ A/ μs		± 0.4		V
t_{tr}	Load transient recovery time			150		μs
t_r	Ramp-up time (from 10-90% of V_{Oi})	10-100% of max I_O , $T_{P1}, T_{P3} = 25^{\circ}\text{C}$, $V_I = 53$ V		20		ms
t_s	Start-up time (from V_I connection to 90% of V_{Oi})			38		ms
t_f	Vin shutdown fall time (from V_I off to 10% of V_O)	max I_O		3.6		ms
		$I_O = 0$ A, $C_O = 0$ mF		7		s
t_{RC}	RC start-up time	max I_O		25		ms
	RC shutdown fall time (from RC off to 10% of V_O)	max I_O		5.1		ms
		$I_O = 0$ A, $C_O = 0$ mF			7	
I_O	Output current		0		35	A
I_{lim}	Current limit threshold	$V_O = 10.8$ V, $T_{P1}, T_{P3} < \max T_{P1}, T_{P3}$	37	41	44	A
I_{sc}	Short circuit current	$T_{P1}, T_{P3} = 25^{\circ}\text{C}$, see Note 1		12		A
C_{out}	Recommended Capacitive Load	$T_{P1}, T_{P3} = 25^{\circ}\text{C}$, see Note 2	0.1	3.5	15	mF
V_{Oac}	Output ripple & noise	See ripple & noise section, max I_O , see Note 3		60	150	mVp-p
OVP	Over voltage protection	$T_{P1}, T_{P3} = 25^{\circ}\text{C}$, $V_I = 53$ V, 10-100% of max I_O		15.6		V
RC	Sink current, see Note 4	See operating information			0.7	mA
	Trigger level	Decreasing / Increasing RC-voltage		2.6 / 2.9		V

Note 1: OCP in hic-up mode

Note 2: Low ESR-value

 Note 3: $C_{out} = 100$ μF , external capacitance

Note 4: Sink current drawn by external device connected to the RC pin. Minimum sink current required guaranteeing activated RC function.

BMR456 series Fully regulated Advanced Bus Converters
 Input 36-75 V, Output up to 39 A / 468 W

1/28701-FGC 101 1823 revG September 2017

© Flex

Typical Characteristics
12.0 V, 35 A / 420 W

BMR 456 0004/018

Efficiency

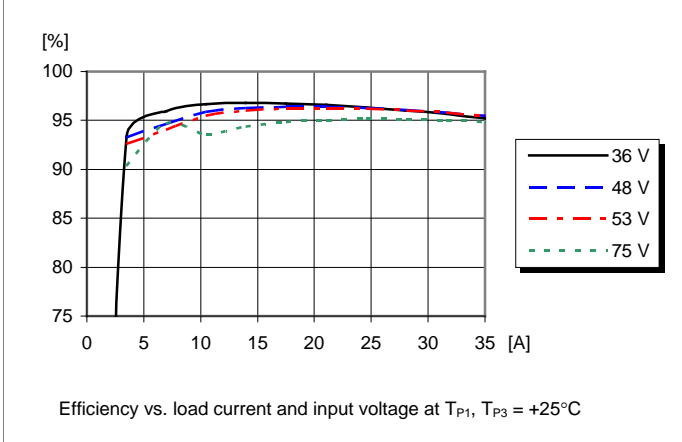

Power Dissipation

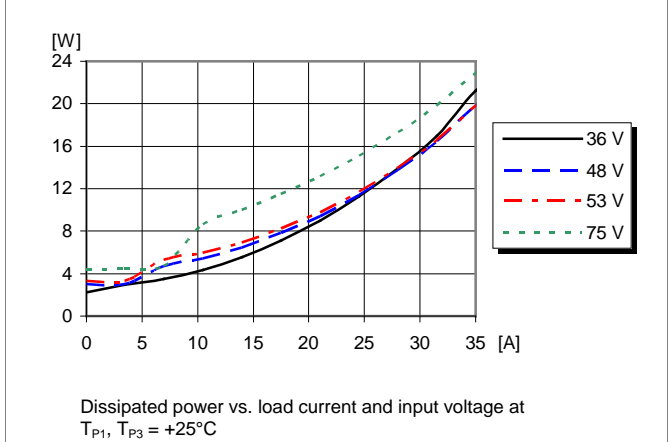

Output Characteristics

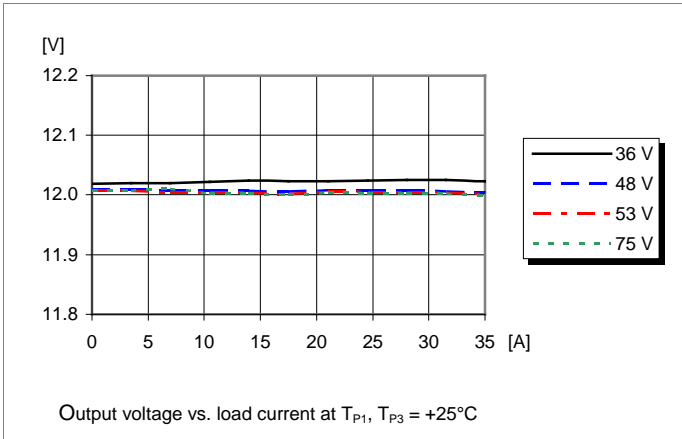

Current Limit Characteristics

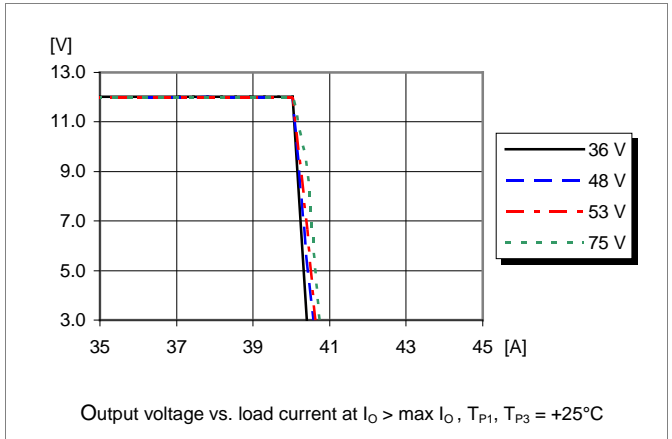

BMR456 series Fully regulated Advanced Bus Converters
 Input 36-75 V, Output up to 39 A / 468 W

1/28701-FGC 101 1823 revG September 2017

© Flex

Typical Characteristics

BMR 456 0004/018

12.0 V, 35 A / 420 W

Start-up

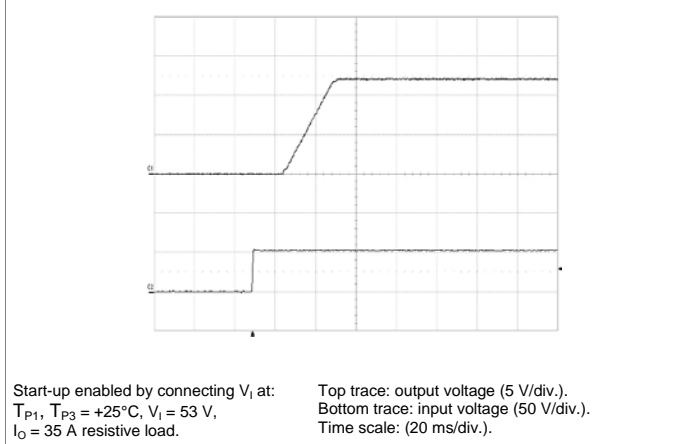

Shut-down

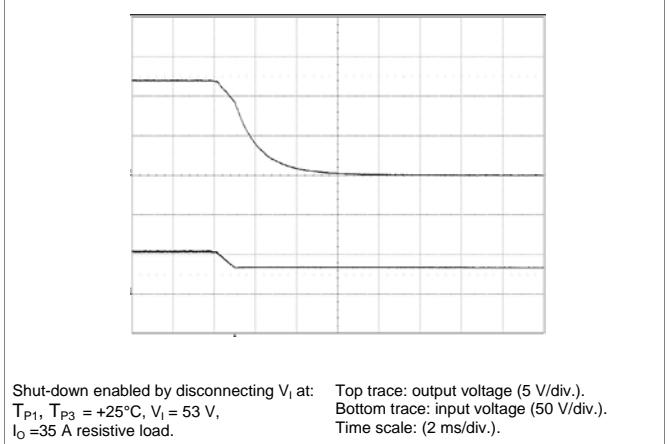

Output Ripple & Noise

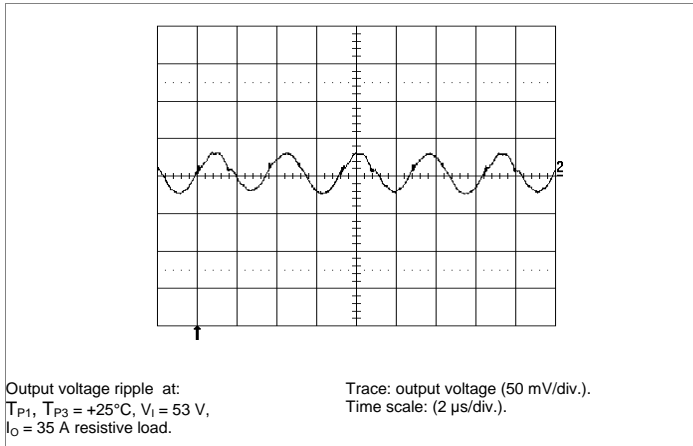

Output Load Transient Response

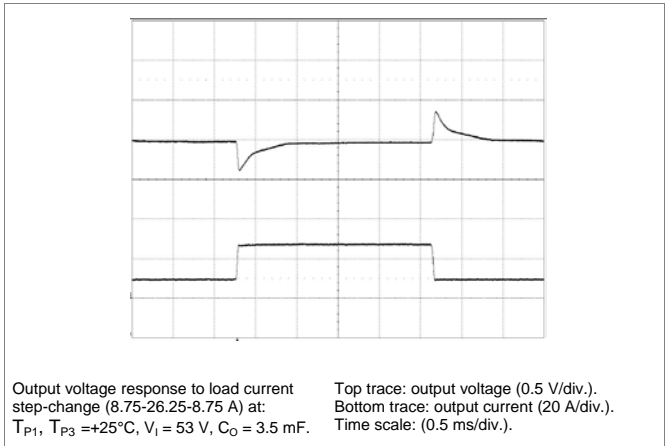

Input Voltage Transient Response

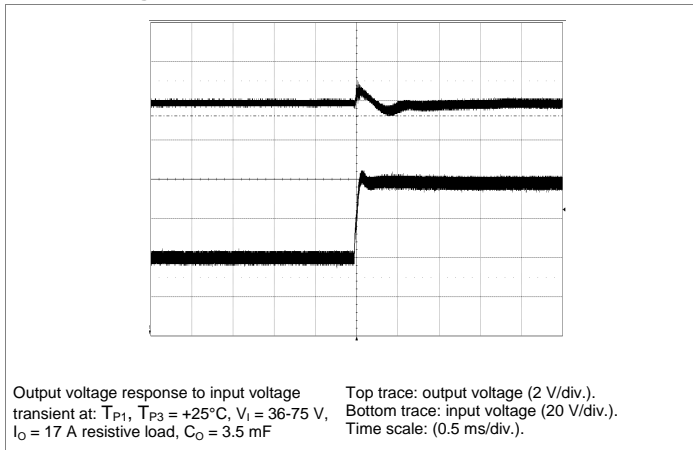

BMR456 series Fully regulated Advanced Bus Converters
 Input 36-75 V, Output up to 39 A / 468 W

1/28701-FGC 101 1823 revG September 2017

© Flex

Typical Characteristics 12.0 V, 35 A / 420 W

BMR 456 0004/018

Output Current Derating – Open frame

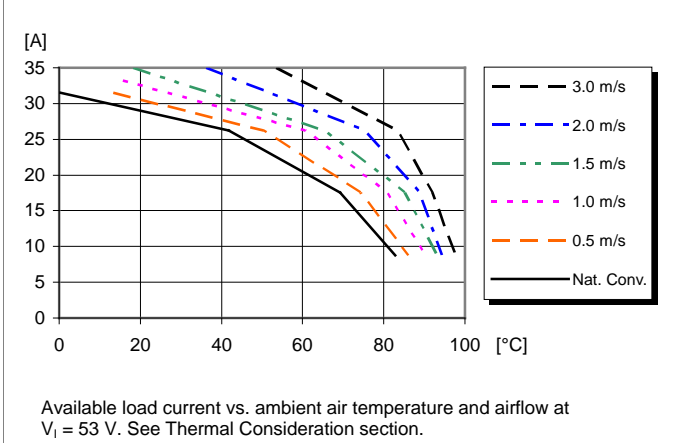

Output Current Derating – Base plate

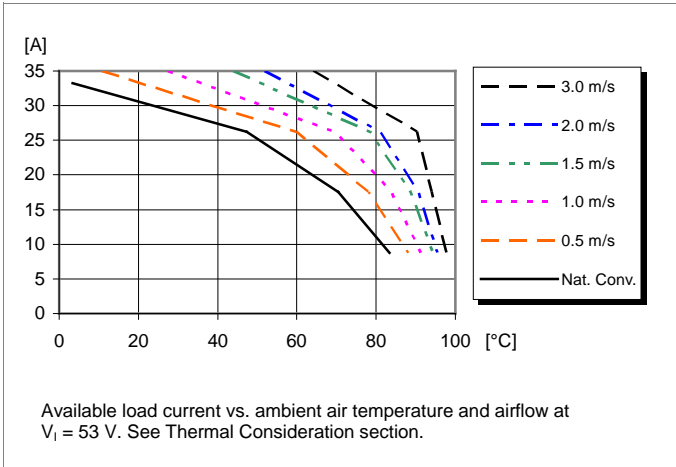

Thermal Resistance – Base plate

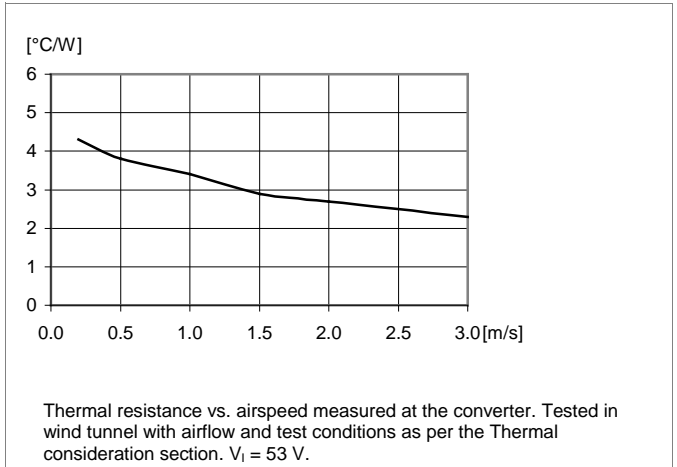

Output Current Derating – Base plate + Heat sink

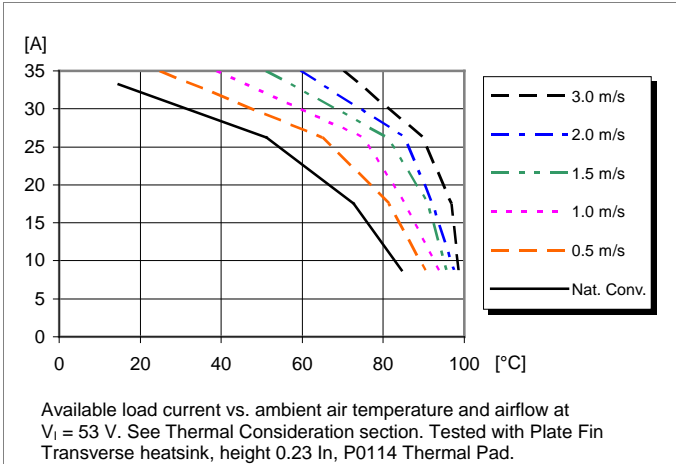

Output Current Derating – Cold wall sealed box

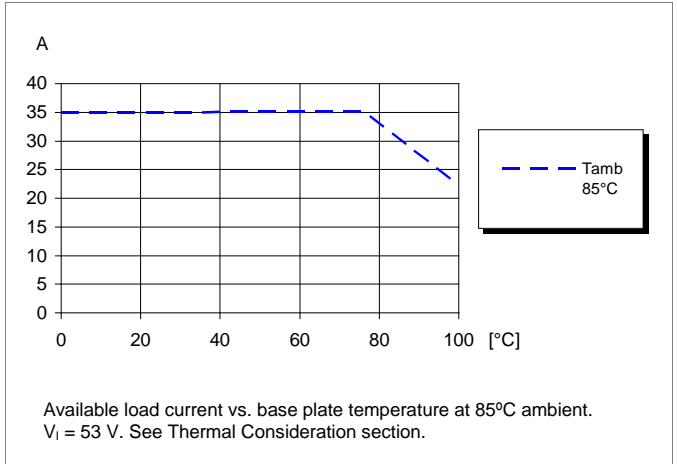

BMR456 series Fully regulated Advanced Bus Converters
 Input 36-75 V, Output up to 39 A / 468 W

1/28701-FGC 101 1823 revG September 2017

© Flex

12.0 V, 39 A / 468 W Electrical Specification
BMR 456 0000/002
 $T_{P1}, T_{P3} = -40$ to $+90^{\circ}\text{C}$, $V_I = 40$ to 60 V, sense pins connected to output pins unless otherwise specified under Conditions.

 Typical values given at: $T_{P1}, T_{P3} = +25^{\circ}\text{C}$, $V_I = 53$ V, max I_O , unless otherwise specified under Conditions.

 Additional $C_{in} = 0.1$ mF, $C_{out} = 3.9$ mF.

Characteristics		Conditions	min	typ	max	Unit
V_I	Input voltage range		40		60	V
V_{loff}	Turn-off input voltage	Decreasing input voltage	36	37	38	V
V_{lon}	Turn-on input voltage	Increasing input voltage	38	39	40	V
C_I	Internal input capacitance			18		μF
P_O	Output power		0		468	W
η	Efficiency	50% of max I_O		96.7		%
		max I_O		95.7		
		50% of max I_O , $V_I = 48$ V		96.8		
		max I_O , $V_I = 48$ V		95.6		
P_d	Power Dissipation	max I_O		21.2	30.5	W
P_{li}	Input idling power	$I_O = 0$ A, $V_I = 53$ V		2.8		W
P_{RC}	Input standby power	$V_I = 53$ V (turned off with RC)		0.4		W
f_s	Default switching frequency	0-100% of max I_O	133	140	147	kHz

V_{Oi}	Output voltage initial setting and accuracy	$T_{P1} = +25^{\circ}\text{C}$, $V_I = 53$ V, $I_O = 39$ A	11.88	12.0	12.12	V
V_O	Output adjust range	See operating information	4.0		13.2	V
	Output voltage tolerance band	0-100% of max I_O	11.76		12.24	V
	Line regulation	max I_O		31	60	mV
	Load regulation	$V_I = 53$ V, 1-100% of max I_O		5	25	mV
V_{tr}	Load transient voltage deviation	$V_I = 53$ V, Load step 25-75-25% of max I_O , $di/dt = 1$ A/ μs		± 0.4		V
t_{tr}	Load transient recovery time			150		μs
t_r	Ramp-up time (from 10-90% of V_{Oi})	10-100% of max I_O , $T_{P1} = 25^{\circ}\text{C}$, $V_I = 53$ V		8		ms
t_s	Start-up time (from V_I connection to 90% of V_{Oi})			24		ms
t_f	Vin shutdown fall time (from V_I off to 10% of V_O)	max I_O		3		ms
		$I_O = 0$ A, $C_O = 0$ mF		7		s
t_{RC}	RC start-up time	max I_O		12		ms
	RC shutdown fall time (from RC off to 10% of V_O)	max I_O		4.5		ms
		$I_O = 0$ A, $C_O = 0$ mF			7	
I_O	Output current		0		39	A
I_{lim}	Current limit threshold	$V_O = 10.8$ V, $T_{P1}, T_{P3} < \max T_{P1}, T_{P3}$	41	44	47	A
I_{sc}	Short circuit current	$T_{P1} = 25^{\circ}\text{C}$, see Note 1		14		A
C_{out}	Recommended Capacitive Load	$T_{P1} = 25^{\circ}\text{C}$, see Note 2	0.1	3.9	6	mF
V_{Oac}	Output ripple & noise	See ripple & noise section, max I_O , see Note 3		50	110	mVp-p
OVP	Over voltage protection	$T_{P1}, T_{P3} = 25^{\circ}\text{C}$, $V_I = 53$ V, 10-100% of max I_O		15.6		V
RC	Sink current, see Note 4	See operating information			0.7	mA
	Trigger level	Decreasing / Increasing RC-voltage		2.6 / 2.9		V

Note 1: OCP in hic-up mode

Note 2: Low ESR-value

 Note 3: $C_{out} = 100$ μF , external capacitance

Note 4: Sink current drawn by external device connected to the RC pin. Minimum sink current required guaranteeing activated RC function.

BMR456 series Fully regulated Advanced Bus Converters
 Input 36-75 V, Output up to 39 A / 468 W

1/28701-FGC 101 1823 revG September 2017

© Flex

Typical Characteristics 12.0 V, 39 A / 468 W

BMR 456 0000/002

Efficiency

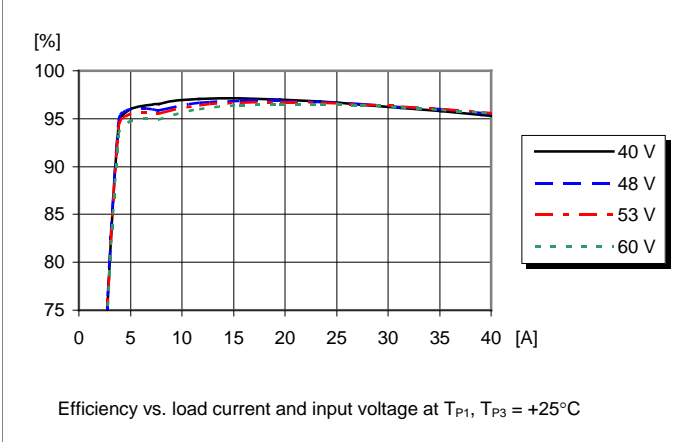

Power Dissipation

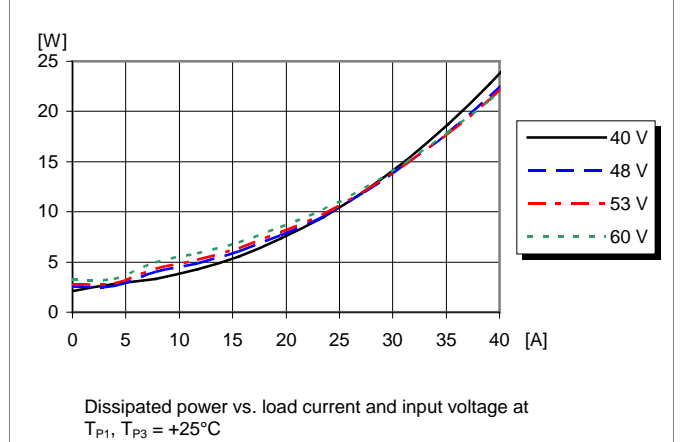

Output Characteristics

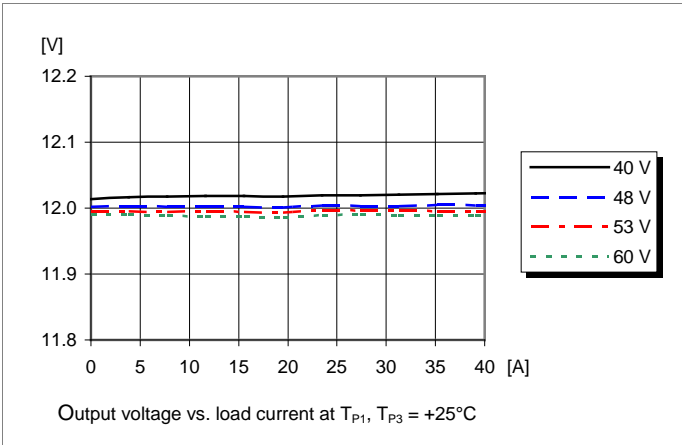

Current Limit Characteristics

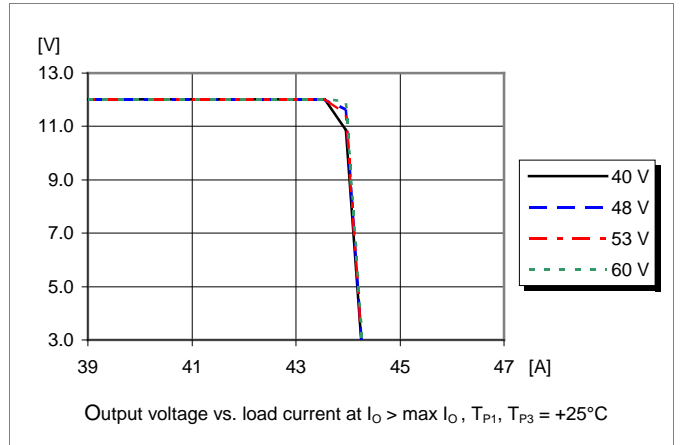

BMR456 series Fully regulated Advanced Bus Converters
Input 36-75 V, Output up to 39 A / 468 W

1/28701-FGC 101 1823 revG September 2017

© Flex

Typical Characteristics

BMR 456 0000/002

12.0 V, 39 A / 468 W

Start-up

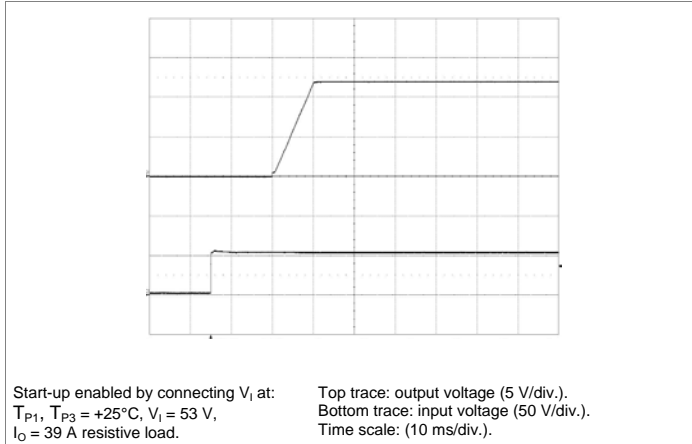

Shut-down

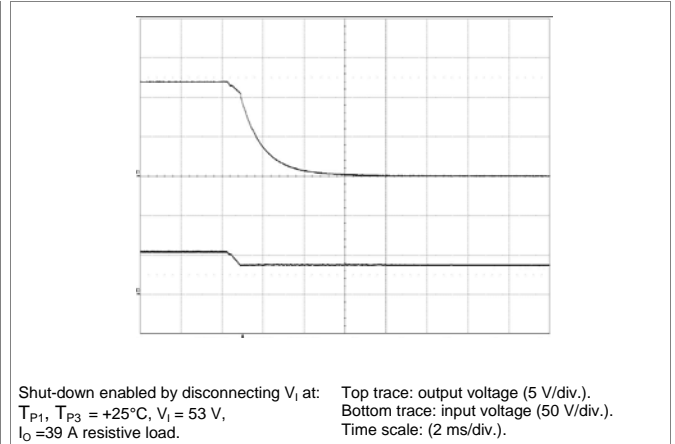

Output Ripple & Noise

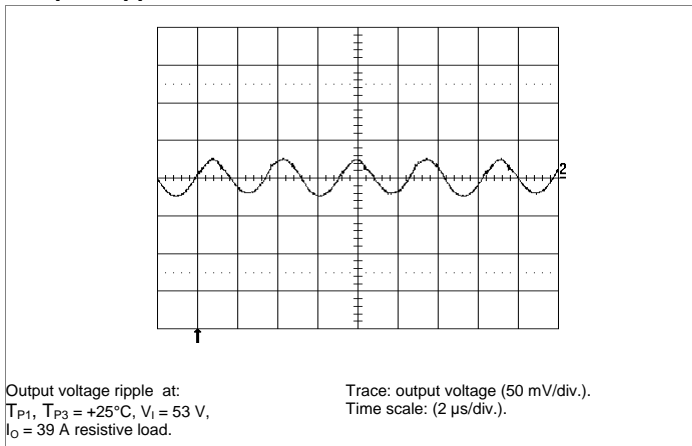

Output Load Transient Response

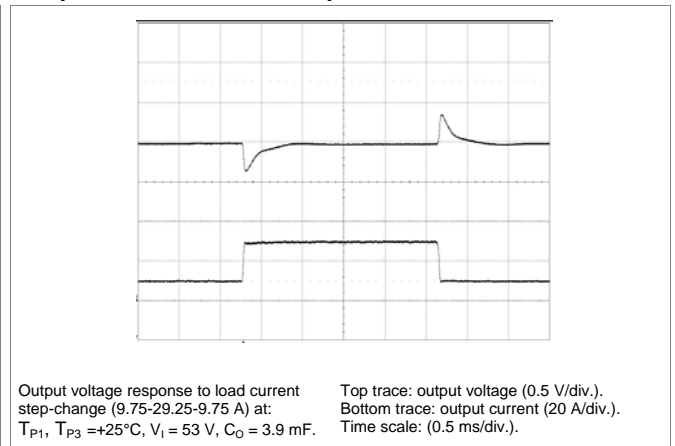

Input Voltage Transient Response

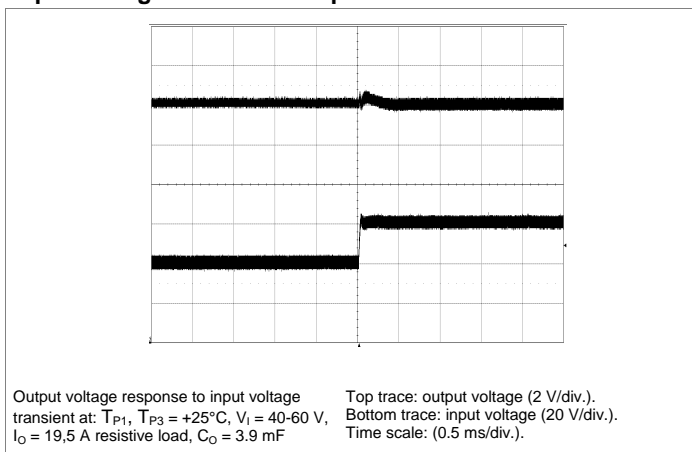

BMR456 series Fully regulated Advanced Bus Converters
 Input 36-75 V, Output up to 39 A / 468 W

1/28701-FGC 101 1823 revG September 2017

© Flex

Typical Characteristics 12.0 V, 39 A / 468 W

BMR 456 0000/002

Output Current Derating – Open frame

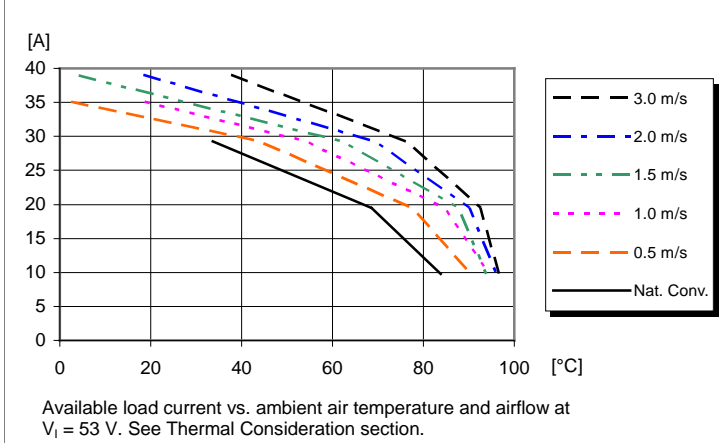

Output Current Derating – Base plate

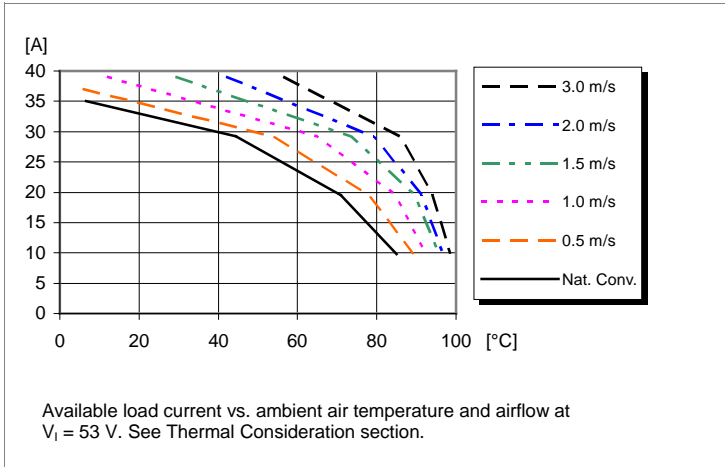

Thermal Resistance – Base plate

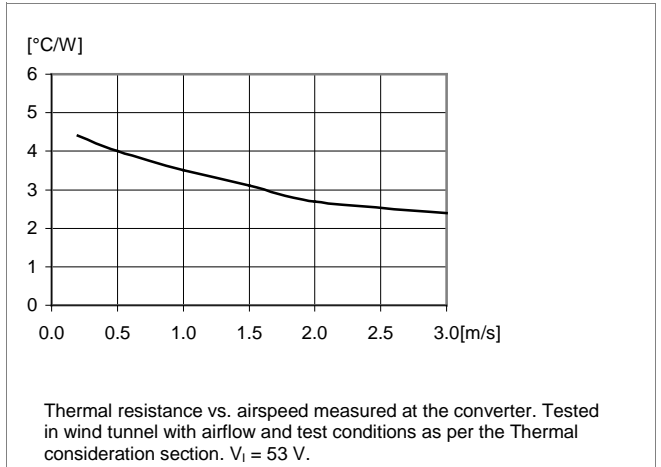

Output Current Derating – Base Plate + Heat sink

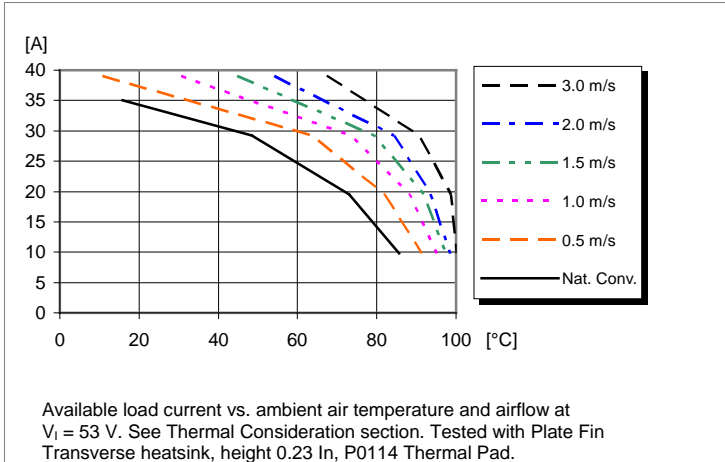

Output Current Derating – Cold wall sealed box

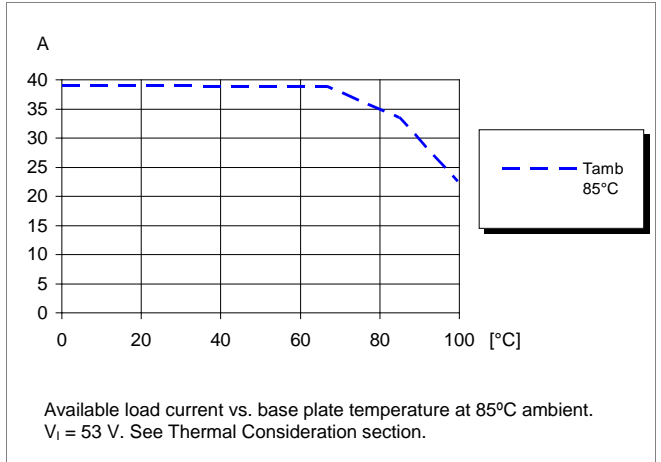

BMR456 series Fully regulated Advanced Bus Converters
 Input 36-75 V, Output up to 39 A / 468 W

1/28701-FGC 101 1823 revG September 2017

© Flex

12.45 V, 35 A / 415 W Electrical Specification
BMR 456 0007/014
 $T_{P1}, T_{P3} = -40$ to $+90^{\circ}\text{C}$, $V_I = 36$ to 75 V, sense pins connected to output pins unless otherwise specified under Conditions.

 Typical values given at: $T_{P1}, T_{P3} = +25^{\circ}\text{C}$, $V_I = 53$ V, max I_O , unless otherwise specified under Conditions.

 Additional $C_{in} = 0.1$ mF, $C_{out} = 3.5$ mF.

Characteristics		Conditions	min	typ	max	Unit
V_I	Input voltage range		36		75	V
V_{loff}	Turn-off input voltage	Decreasing input voltage	32	33	34	V
V_{lon}	Turn-on input voltage	Increasing input voltage	34	35	36	V
C_I	Internal input capacitance			18		μF
P_O	Output power		0		415	W
η	Efficiency	50% of max I_O		96.2		%
		max I_O		95.5		
		50% of max I_O , $V_I = 48$ V		96.4		
		max I_O , $V_I = 48$ V		95.5		
P_d	Power Dissipation	max I_O		19.5	29.5	W
P_{li}	Input idling power	$I_O = 0$ A, $V_I = 53$ V		3.2		W
P_{RC}	Input standby power	$V_I = 53$ V (turned off with RC)		0.4		W
f_s	Default switching frequency	0-100% of max I_O	133	140	147	kHz

V_{Oi}	Output voltage initial setting and accuracy	$T_{P1} = 25^{\circ}\text{C}$, $V_I = 53$ V, $I_O = 0$ A	12.415	12.45	12.485	V
V_O	Output adjust range	See operating information	4.0		13.2	V
	Output voltage tolerance band	0-100% of max I_O	11.5		12.7	V
	Line regulation	max I_O		26	55	mV
	Load regulation	$V_I = 53$ V, 0-100% of max I_O	450	650	860	mV
V_{tr}	Load transient voltage deviation	$V_I = 53$ V, Load step 25-75-25% of max I_O , $di/dt = 1$ A/ μs		± 0.4		V
t_{tr}	Load transient recovery time			150		μs
t_r	Ramp-up time (from 10-90% of V_{Oi})	10-100% of max I_O , $T_{P1}, T_{P3} = 25^{\circ}\text{C}$, $V_I = 53$ V		23		ms
t_s	Start-up time (from V_I connection to 90% of V_{Oi})			39		ms
t_f	Vin shutdown fall time (from V_I off to 10% of V_O)	max I_O		3.6		ms
		$I_O = 0$ A, $C_O = 0$ mF		7		s
t_{RC}	RC start-up time	max I_O		27		ms
	RC shutdown fall time (from RC off to 10% of V_O)	max I_O		5.1		ms
		$I_O = 0$ A, $C_O = 0$ mF			7	
I_O	Output current		0		35	A
I_{lim}	Current limit threshold	$V_O = 10.8$ V, $T_{P1}, T_{P3} < \max T_{P1}, T_{P3}$	37	41	44	A
I_{sc}	Short circuit current	$T_{P1}, T_{P3} = 25^{\circ}\text{C}$, see Note 1		12		A
C_{out}	Recommended Capacitive Load	$T_{P1}, T_{P3} = 25^{\circ}\text{C}$, see Note 2	0.1	3.5	6	mF
V_{Oac}	Output ripple & noise	See ripple & noise section, max I_O , see Note 3		60	150	mVp-p
OVP	Over voltage protection	$T_{P1}, T_{P3} = 25^{\circ}\text{C}$, $V_I = 53$ V, 10-100% of max I_O		15.6		V
RC	Sink current, see Note 4	See operating information			0.7	mA
	Trigger level	Decreasing / Increasing RC-voltage		2.6 / 2.9		V

Note 1: OCP in hic-up mode

Note 2: Low ESR-value

 Note 3: $C_{out} = 100$ μF , external capacitance

Note 4: Sink current drawn by external device connected to the RC pin. Minimum sink current required guaranteeing activated RC function.

BMR456 series Fully regulated Advanced Bus Converters
 Input 36-75 V, Output up to 39 A / 468 W

1/28701-FGC 101 1823 revG September 2017
 © Flex

Typical Characteristics
 12.45 V, 63 A / 747 W, two products in parallel

2 × BMR 456 0007/014

Efficiency

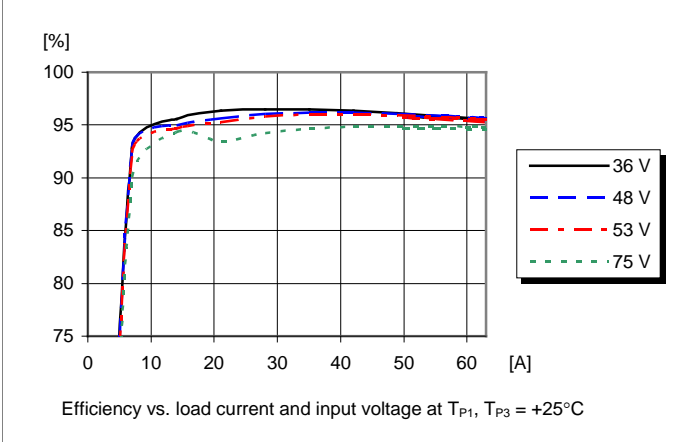

Power Dissipation

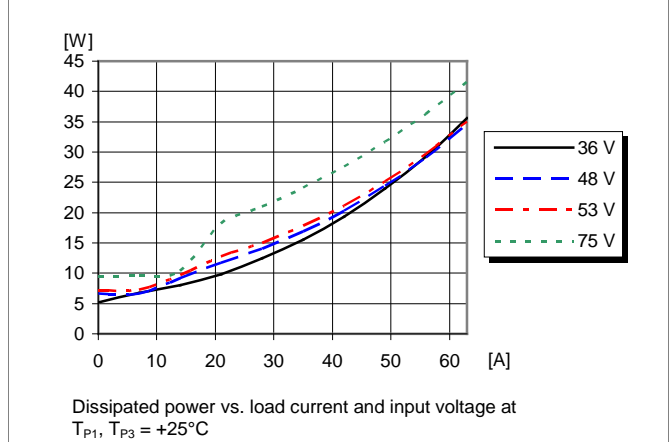

Output Characteristics

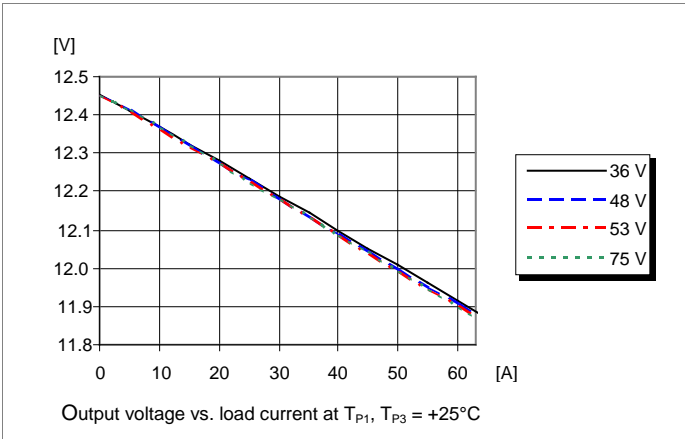

Current Limit Characteristics

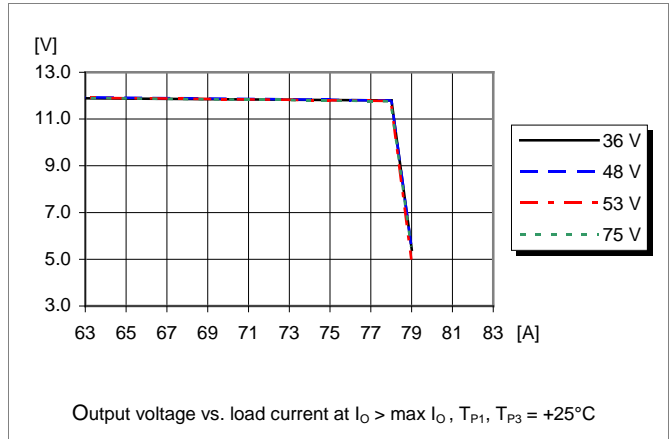

Start-up

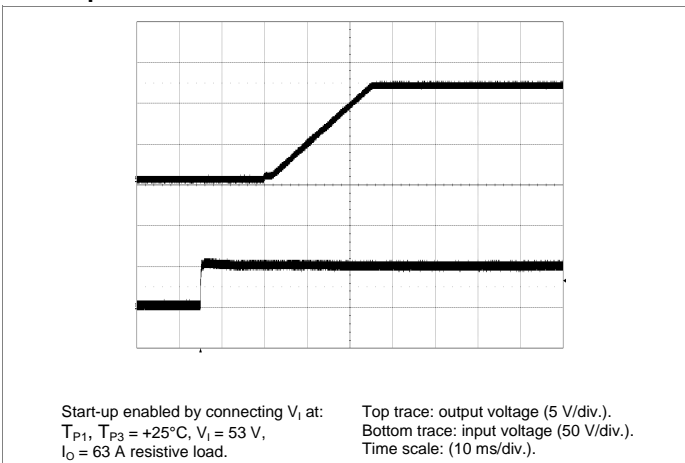

Output Load Transient Response

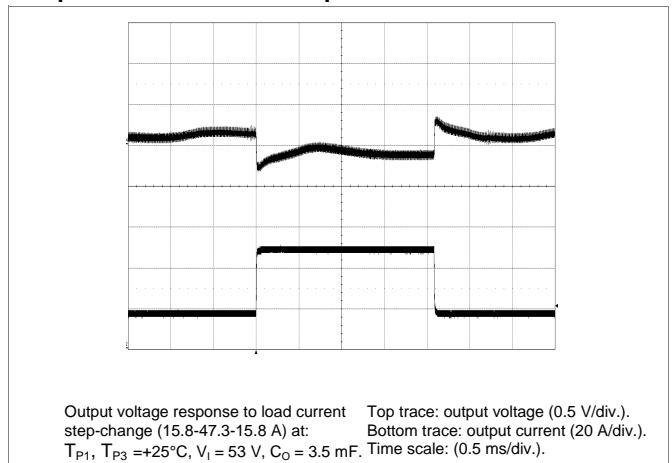

BMR456 series Fully regulated Advanced Bus Converters
 Input 36-75 V, Output up to 39 A / 468 W

1/28701-FGC 101 1823 revG September 2017

© Flex

Typical Characteristics 12.45 V, 35 A / 415 W

BMR 456 0007/014

Output Current Derating – Open frame

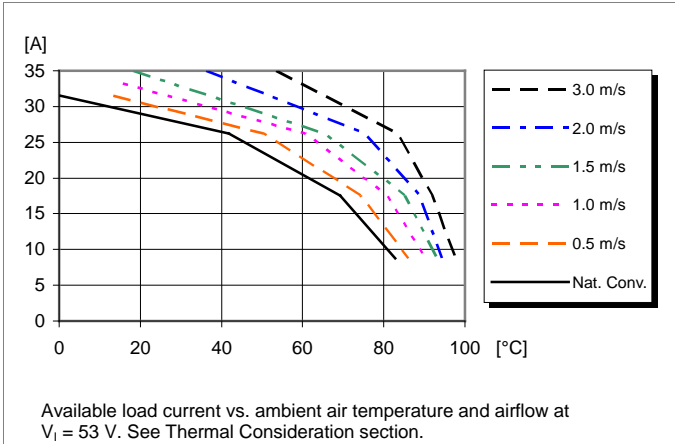

Output Current Derating – Base plate

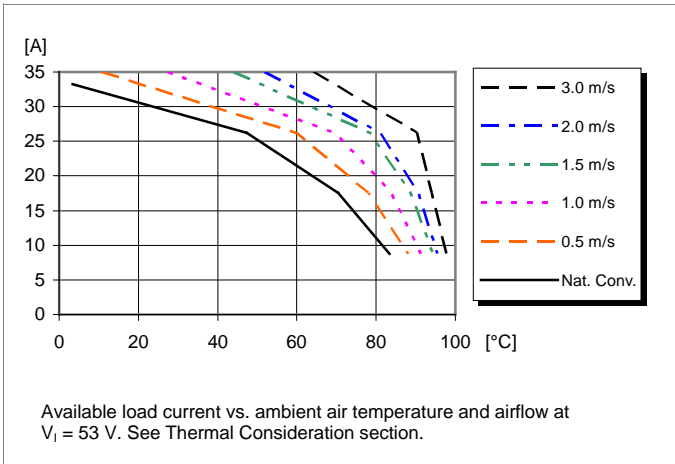

Thermal Resistance – Base plate

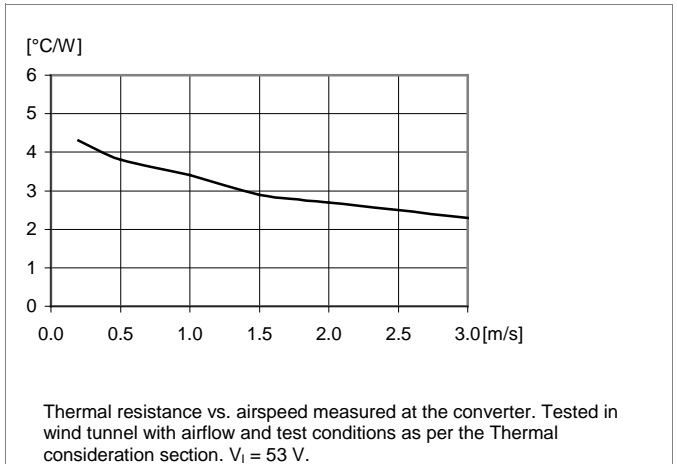

Output Current Derating – Base plate + Heat sink

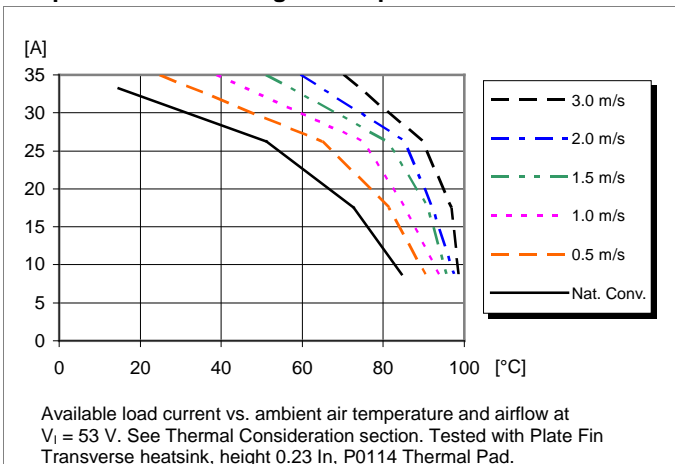

Output Current Derating – Cold wall sealed box

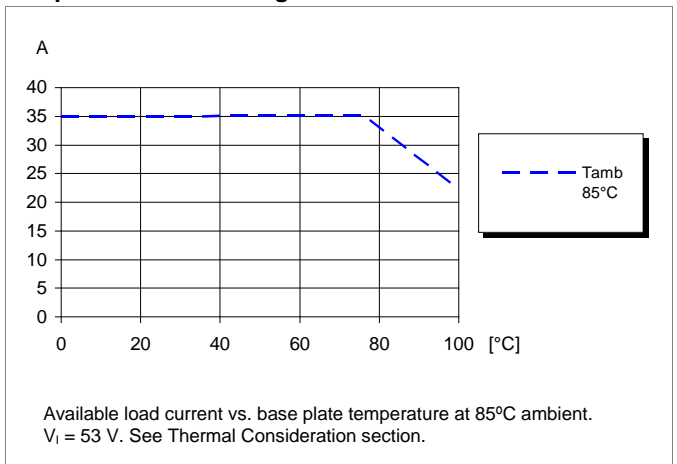

BMR456 series Fully regulated Advanced Bus Converters
 Input 36-75 V, Output up to 39 A / 468 W

1/28701-FGC 101 1823 revG September 2017

© Flex

12.45 V, 39 A / 462 W Electrical Specification
BMR 456 0011/017
 $T_{P1}, T_{P3} = -40$ to $+90^{\circ}\text{C}$, $V_I = 40$ to 60 V, sense pins connected to output pins unless otherwise specified under Conditions.

 Typical values given at: $T_{P1}, T_{P3} = +25^{\circ}\text{C}$, $V_I = 53$ V, max I_O , unless otherwise specified under Conditions.

 Additional $C_{in} = 0.1$ mF, $C_{out} = 3.9$ mF.

Characteristics		Conditions	min	typ	max	Unit
V_I	Input voltage range		40		60	V
V_{loff}	Turn-off input voltage	Decreasing input voltage	36	37	38	V
V_{lon}	Turn-on input voltage	Increasing input voltage	38	39	40	V
C_I	Internal input capacitance			18		μF
P_O	Output power		0		462	W
η	Efficiency	50% of max I_O		96.7		%
		max I_O		95.7		
		50% of max I_O , $V_I = 48$ V		96.8		
		max I_O , $V_I = 48$ V		95.6		
P_d	Power Dissipation	max I_O		21.0	30.5	W
P_{li}	Input idling power	$I_O = 0$ A, $V_I = 53$ V		2.8		W
P_{RC}	Input standby power	$V_I = 53$ V (turned off with RC)		0.4		W
f_s	Default switching frequency	0-100% of max I_O	133	140	147	kHz

V_{Oi}	Output voltage initial setting and accuracy	$T_{P1} = +25^{\circ}\text{C}$, $V_I = 53$ V, $I_O = 0$ A	12.415	12.45	12.485	V
V_O	Output adjust range	See operating information	4.0		13.2	V
	Output voltage tolerance band	0-100% of max I_O	11.5		12.7	V
	Line regulation	max I_O		31	60	mV
	Load regulation	$V_I = 53$ V, 0-100% of max I_O	450	600	800	mV
V_{tr}	Load transient voltage deviation	$V_I = 53$ V, Load step 25-75-25% of max I_O , $di/dt = 1$ A/ μs		± 0.4		V
t_{tr}	Load transient recovery time			150		μs
t_r	Ramp-up time (from 10-90% of V_{Oi})	10-100% of max I_O , $T_{P1} = 25^{\circ}\text{C}$, $V_I = 53$ V		23		ms
t_s	Start-up time (from V_I connection to 90% of V_{Oi})			39		ms
t_f	Vin shutdown fall time (from V_I off to 10% of V_O)	max I_O		3		ms
		$I_O = 0$ A, $C_O = 0$ mF		7		s
t_{RC}	RC start-up time	max I_O		27		ms
	RC shutdown fall time (from RC off to 10% of V_O)	max I_O		4.5		ms
		$I_O = 0$ A, $C_O = 0$ mF			7	
I_O	Output current		0		39	A
I_{lim}	Current limit threshold	$V_O = 10.8$ V, $T_{P1}, T_{P3} < \max T_{P1}, T_{P3}$	41	44	47	A
I_{sc}	Short circuit current	$T_{P1} = 25^{\circ}\text{C}$, see Note 1		14		A
C_{out}	Recommended Capacitive Load	$T_{P1} = 25^{\circ}\text{C}$, see Note 2	0.1	3.9	6	mF
V_{Oac}	Output ripple & noise	See ripple & noise section, max I_O , see Note 3		50	110	mVp-p
OVP	Over voltage protection	$T_{P1}, T_{P3} = 25^{\circ}\text{C}$, $V_I = 53$ V, 10-100% of max I_O		15.6		V
RC	Sink current, see Note 4	See operating information			0.7	mA
	Trigger level	Decreasing / Increasing RC-voltage		2.6 / 2.9		V

Note 1: OCP in hic-up mode

Note 2: Low ESR-value

 Note 3: $C_{out} = 100$ μF , external capacitance

Note 4: Sink current drawn by external device connected to the RC pin. Minimum sink current required guaranteeing activated RC function.

BMR456 series Fully regulated Advanced Bus Converters
 Input 36-75 V, Output up to 39 A / 468 W

1/28701-FGC 101 1823 revG September 2017

© Flex

Typical Characteristics
 12.45 V, 70 A / 830 W, two products in parallel

2 × BMR 456 0011/017

Efficiency

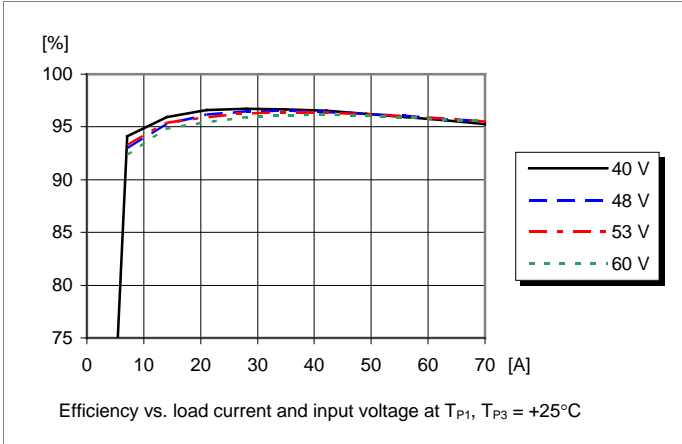

Power Dissipation

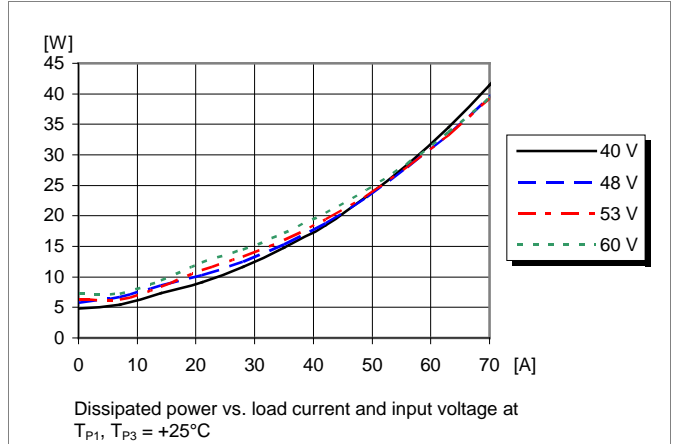

Output Characteristics

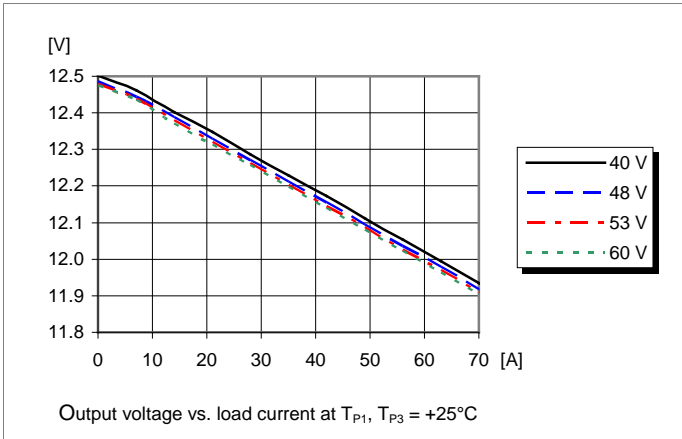

Current Limit Characteristics

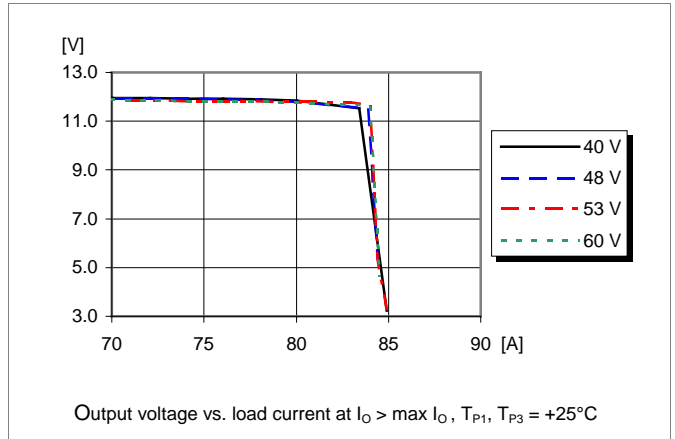

Start-up

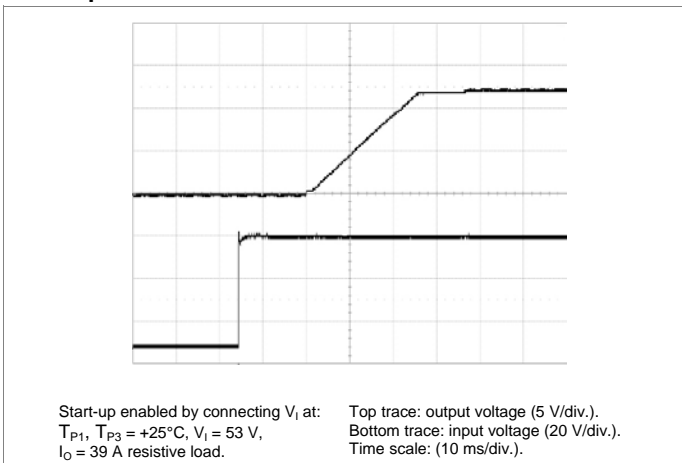

Output Load Transient Response

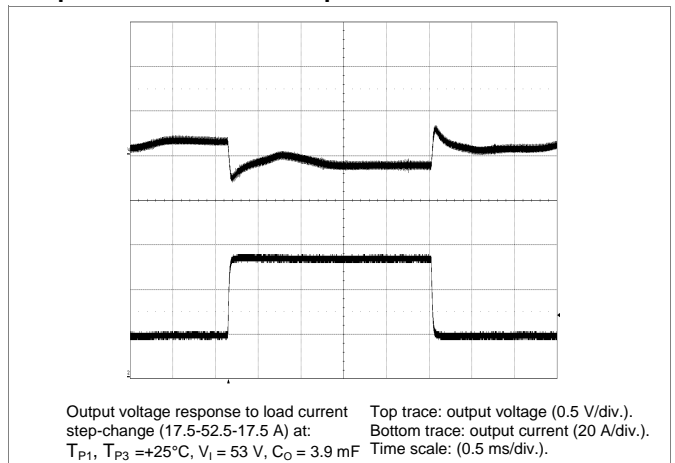

BMR456 series Fully regulated Advanced Bus Converters
 Input 36-75 V, Output up to 39 A / 468 W

1/28701-FGC 101 1823 revG September 2017

© Flex

Typical Characteristics

BMR 456 0011/017

12.45 V, 39 A / 462 W

Output Current Derating – Open frame

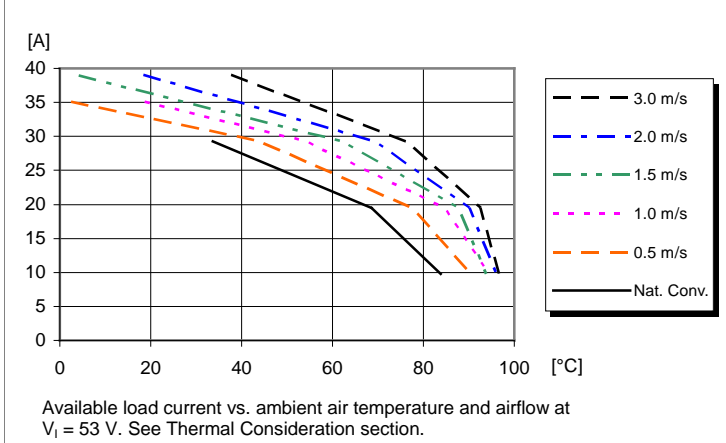

Output Current Derating – Base plate

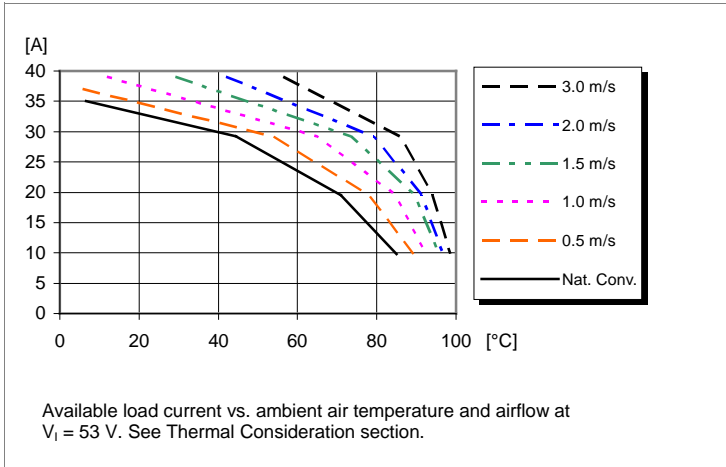

Thermal Resistance – Base plate

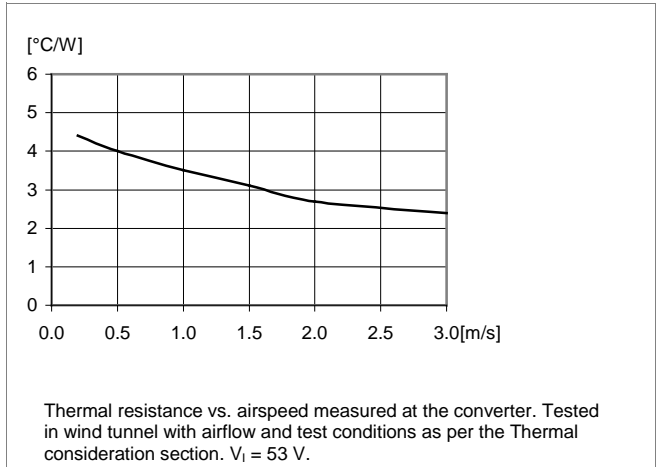

Output Current Derating – Base Plate + Heat sink

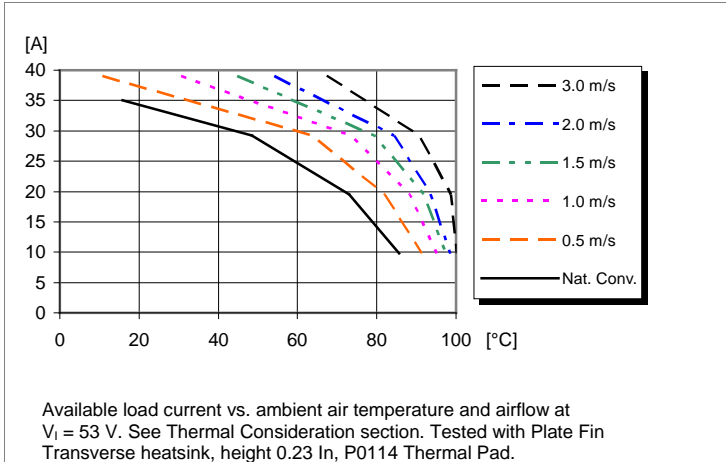

Output Current Derating – Cold wall sealed box

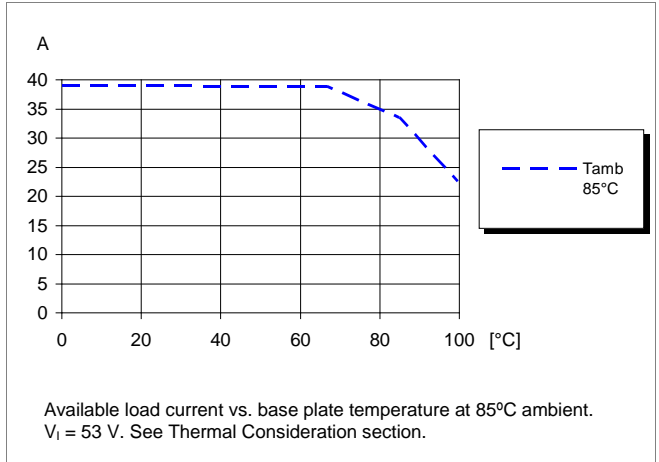

BMR456 series Fully regulated Advanced Bus Converters
 Input 36-75 V, Output up to 39 A / 468 W

1/28701-FGC 101 1823 revG September 2017

© Flex

EMC Specification

Conducted EMI measured according to EN55022, CISPR 22 and FCC part 15J (see test set-up). See Design Note 009 for detailed information. The fundamental switching frequency is 140 kHz for BMR 456 at $V_I = 53$ V, max I_O .

Conducted EMI Input terminal value (typ)

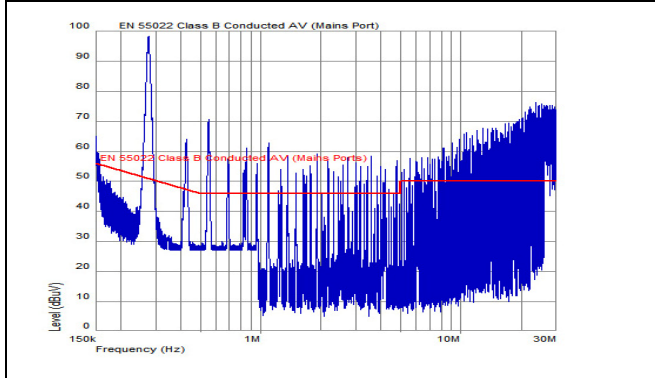

EMI without filter

Optional external filter for class B

Suggested external input filter in order to meet class B in EN 55022, CISPR 22 and FCC part 15J.

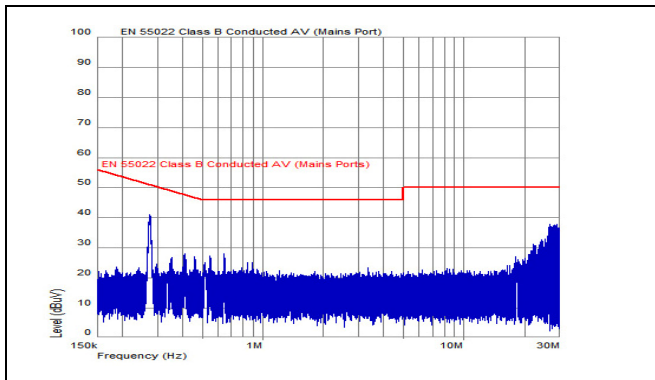
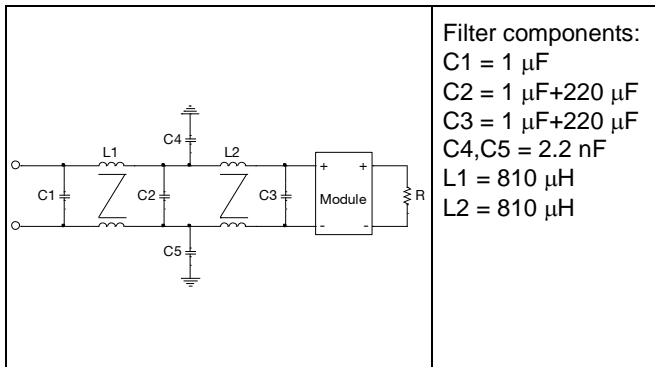

EMI with filter

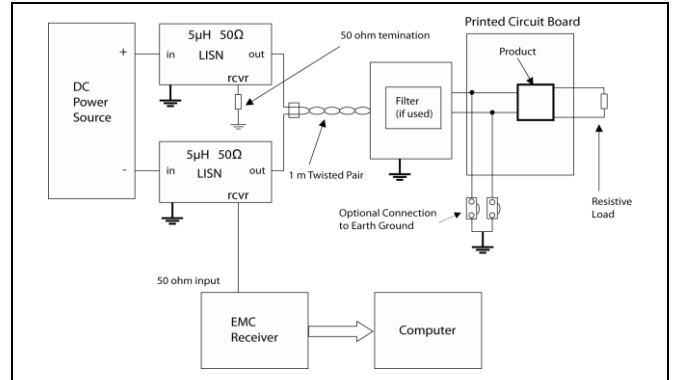

Test set-up

Layout recommendations

The radiated EMI performance of the product will depend on the PWB layout and ground layer design. It is also important to consider the stand-off of the product. If a ground layer is used, it should be connected to the output of the product and the equipment ground or chassis.

A ground layer will increase the stray capacitance in the PWB and improve the high frequency EMC performance.

Output ripple and noise

Output ripple and noise measured according to figure below. See Design Note 022 for detailed information.

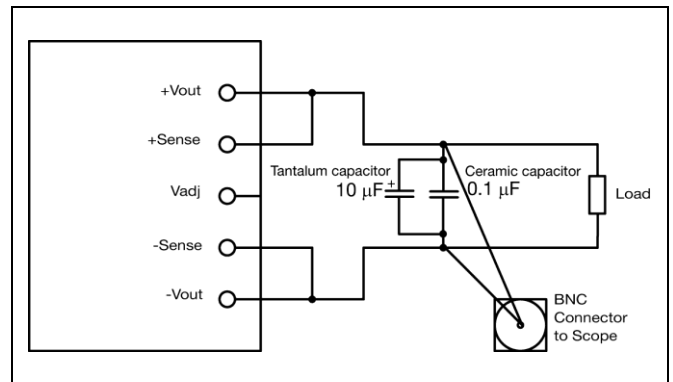

Output ripple and noise test setup

BMR456 series Fully regulated Advanced Bus Converters
Input 36-75 V, Output up to 39 A / 468 W

1/28701-FGC 101 1823 revG September 2017

© Flex

Operating information

Power Management Overview

This product is equipped with a PMBus interface. The product incorporates a wide range of readable and configurable power management features that are simple to implement with a minimum of external components. Additionally, the product includes protection features that continuously safeguard the load from damage due to unexpected system faults. A fault is also shown as an alert on the SALERT pin. The following product parameters can continuously be monitored by a host: Input voltage, output voltage/current, duty cycle and internal temperature.

The product is delivered with a default configuration suitable for a wide range operation in terms of input voltage, output voltage, and load. The configuration is stored in an internal Non-Volatile Memory (NVM). All power management functions can be reconfigured using the PMBus interface. Please contact your local Flex Power Modules representative for design support of custom configurations or appropriate SW tools for design and down-load of your own configurations.

Input Voltage

The BMR456 consists of two different product families designed for two different input voltage ranges, 36 to 75 Vdc and 40 to 60 Vdc, see ordering information.

The input voltage range 36 to 75 Vdc meets the requirements of the European Telecom Standard ETS 300 132-2 for normal input voltage range in -48 and -60 Vdc systems, -40.5 to -57.0 V and -50.0 to -72 V respectively.

At input voltages exceeding 75 V, the power loss will be higher than at normal input voltage and T_{P1} must be limited to absolute max +125°C. The absolute maximum continuous input voltage is 80 Vdc.

The input voltage range 40 to 60 Vdc meets the requirements for normal input voltage range in -48 V systems, -40.5 to -57.0 V. At input voltages exceeding 60 V, the power loss will be higher than at normal input voltage and T_{P1} must be limited to absolute max +125°C. The absolute maximum continuous input voltage is 65 Vdc.

Turn-off Input Voltage

The product monitors the input voltage and will turn on and turn off at predetermined levels. The minimum hysteresis between turn on and turn off input voltage is 2 V. The turn on and turn off levels of the product can be reconfigured using the PMBus interface

Remote Control (RC)

The products are fitted with a configurable remote control function. The primary remote control is referenced to the primary negative input connection (-In). The RC function allows the converter to be turned on/off by an external device like a semiconductor or mechanical switch. The RC pin has an

internal pull up resistor. The remote control functions can also be configured using the PMBus

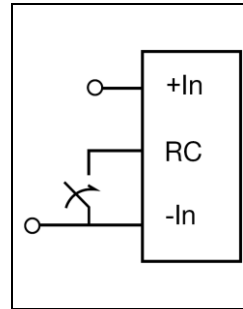

The device should be capable of sinking 0.7 mA. When the RC pin is left open, the voltage generated on the RC pin is max 6 V. The standard product is provided with “negative logic” remote control and will be off until the RC pin is connected to the -In. To turn on the product the voltage between RC pin and -In should be less than 1 V.

To turn off the product the RC pin should be left open for a minimum of time 150 μ s, the same time requirement applies when the product shall turn on. In situations where it is desired to have the product to power up automatically without the need for control signals or a switch, the RC pin can be wired directly to -In or disabled via the 0xE3 command. The logic option for the primary remote control is configured via 0xE3 command using the PMBus.

Remote Control (secondary side)

The CTRL-pin can be configured as remote control via the PMBus interface. In the default configuration the CTRL-pin is disabled and floating. The output can be configured to internal pull-up to 3.3 V using the MFR_MULTI_PIN_CONFIG (0xF9) PMBus command. The CTRL-pin can be left open when not used. The logic options for the secondary remote control can be positive or negative logic. The logic option for the secondary remote control is configured via ON_OFF_CONFIG (0x02) command using the PMBus interface, see also MFR_MULTI_PIN_CONFIG section.

Input and Output Impedance

The impedance of both the input source and the load will interact with the impedance of the product. It is important that the input source has low characteristic impedance. Minimum recommended external input capacitance is 100 μ F. The effective value of electrolytic capacitors is typically reduced in low temperature. The needed input capacitance in low temperature should be equivalent to 100 μ F. The performance in some applications can be enhanced by addition of external capacitance as described under External Decoupling Capacitors.

External Decoupling Capacitors

When powering loads with significant dynamic current requirements, the voltage regulation at the point of load can be improved by addition of decoupling capacitors at the load. The most effective technique is to locate low ESR ceramic and electrolytic capacitors as close to the load as possible, using several parallel capacitors to lower the effective ESR. The ceramic capacitors will handle high-frequency dynamic load changes while the electrolytic capacitors are used to handle low frequency dynamic load changes. Ceramic capacitors will

BMR456 series Fully regulated Advanced Bus Converters

Input 36-75 V, Output up to 39 A / 468 W

1/28701-FGC 101 1823 revG September 2017

© Flex

also reduce any high frequency noise at the load. It is equally important to use low resistance and low inductance PWB layouts and cabling. External decoupling capacitors will become part of the product's control loop. The control loop is optimized for a wide range of external capacitance and the maximum recommended value that could be used without any additional analysis is found in the electrical specification. The ESR of the capacitors is a very important parameter. Stable operation is guaranteed with a verified ESR value of $>10\text{ m}\Omega$ across the output connections.

For further information please contact your local Flex Power Modules representative.

Parallel Operation (Droop Load Share, DLS)

BMR456 Series with DSL option (See Product Ordering Info on page 2) for paralleling / load-share operation. The output voltage will decrease when the load current is increased. Maximum output voltage droop is 600mV at rated maximum load. Up to 4 same DLS modules can be paralleled together. Load-share accuracy is within 10%, and is up to 90% of max rated current from each module.

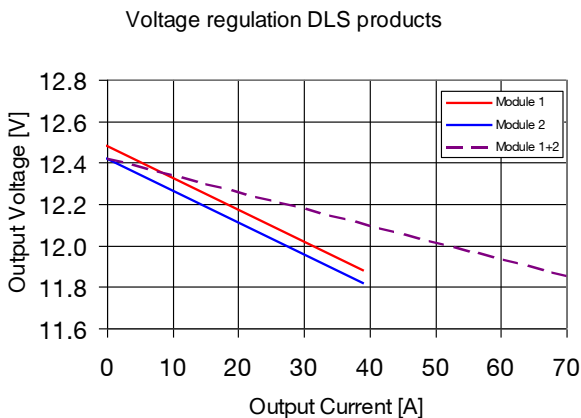

To prevent unnecessary current stress, changes of the output voltage must be done with the output disabled. This must be considered for all commands that affect the output voltage.

During start-up, it is recommended to establish a start-up delay between parallel modules. One module is allowed to come up completely then remaining modules will have a fixed pre-bias voltage to start-up.

Start-up recommendation:

Method 1:

Establish a delay between each parallel module by changing start-up delay time. It is recommended that the customer designate one module to start first, and set a Turn on delay in the ramp of all remaining paralleled modules to the value that ensures that they begin their ramp up after a ramp up of the first module is completed. This will establish a stable output voltage bus when all other modules begin the ramp. Default Ton delay is set to 1ms and default Ramp up time is 25ms, so if default settings for the first unit are maintained, it is recommended to set Ton delay for follow up devices to 36ms.

Method 2:

All modules are turn on via separated RC. Turn on one module first, after 35ms delay turn on all remain modules.

The total load of the parallel modules should be kept below one module's capability till all the modules have completed ramp-up and in regulated mode.

Feed Forward Capability

The BMR456 products have a feed forward function implemented that can handle sudden input voltage changes. The output voltage will be regulated during an input transient and will typically stay within 10% when an input transient is applied.

PMBus configuration and support

The product provides a PMBus digital interface that enables the user to configure many aspects of the device operation as well as monitor the input and output parameters. Please contact your local Flex Power Modules representative for appropriate SW tools to down-load new configurations.

Output Voltage Adjust using PMBus

The output voltage of the product can be reconfigured using the PMBus interface.

Margin Up/Down Controls

These controls allow the output voltage to be momentarily adjusted, either up or down, by a nominal 10%. This provides a convenient method for dynamically testing the operation of the load circuit over its supply margin or range. It can also be used to verify the function of supply voltage supervisors. The margin up and down levels of the product can be re-configured using the PMBus interface.

Soft-start Power Up

The default rise time of the ramp up is 10 ms. When starting by applying input voltage the control circuit boot-up time adds an additional 15 ms delay. The soft-start power up of the product can be reconfigured using the PMBus interface. The DLS variants have a pre-configured ramp up time of 25 ms.

Remote Sense

The product has remote sense that can be used to compensate for voltage drops between the output and the point of load. The sense traces should be located close to the PWB ground layer to reduce noise susceptibility. The remote sense circuitry will compensate for up to 10% voltage drop between output pins and the point of load. If the remote sense is not needed +Sense should be connected to +Out and -Sense should be connected to -Out. To be able to use remote sense the converter must be equipped with a Communication interface.

Temperature Protection (OTP, UTP)

BMR456 series Fully regulated Advanced Bus Converters Input 36-75 V, Output up to 39 A / 468 W

1/28701-FGC 101 1823 revG September 2017

© Flex

1) When not used with PMBus, the CTRL input can be internally pulled up or down depending on if it is active high or low. When active low it will be pulled up and vice versa	DLS, PMBus Control (0x82)
	DLS, Sec RC w/ pull up/down (0x83)
	DLS, Power Good Push-pull, PMBus Control (0x86)
	DLS, Power Good Push-pull, Sec.RC.w/ pull up/down (0x87)
	DLS, Power Good High Z when active, PMBus Control (0x86)
	DLS, Power Good High Z when active, Sec.RC.w/ pull up/down (0x87)
	Stand alone, PMBus Control (0x00)
	Stand alone, Sec RC w/ pull up/down (0x01)
	Stand alone, Power Good Push-pull, PMBus Control (0x04)
	Stand alone, Power Good Push-pull, Sec.RC.w/ pull up/down (0x05)
Stand alone, Power Good High Z when active, PMBus Control (0x24)	
Stand alone, Power Good High Z when active, Sec.RC.w/ pull up/down (0x25)	

The MFR_MULTI_PIN_CONFIG can be reconfigured using the PMBus interface. Default configuration is set to Power Good Push-Pull (0x04) for stand alone variants and DLS Power Good Push-Pull (0x86) for Droop Load Share variants.

User customized settings

This product has two data storage set: Default data (Flex factory) and User data. The User data set's priority is higher than the Default data. The User data area is empty while shipped to customer. After boot-up, if the controller found no data stored in User data area, it will load Default data instead. Customer can change the RAM data and store the changes into flash memory by PMBUS Store_User_All, next power cycle will load the User data into RAM for execute. Store_Default_All is write protected to ensure the factory settings is always available for recovery.

Output Voltage Regulation

The BMR456 products are designed to be fully regulated within the plotted area. Operating outside this area is not recommended.

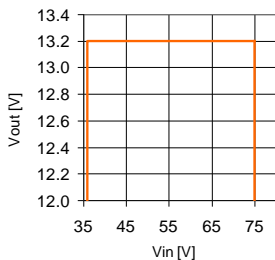

Vin range: 36-75Vdc

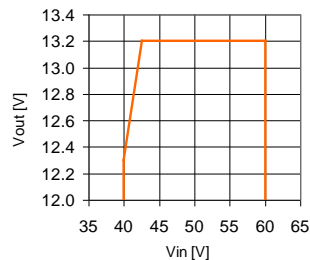

Vin range: 40-60Vdc

BMR456 series Fully regulated Advanced Bus Converters
 Input 36-75 V, Output up to 39 A / 468 W

1/28701-FGC 101 1823 revG September 2017

© Flex

Thermal Consideration

General

The product is designed to operate in different thermal environments and sufficient cooling must be provided to ensure reliable operation. For products mounted on a PWB without a heat sink attached, cooling is achieved mainly by conduction, from the pins to the host board, and convection, which is dependant on the airflow across the product. Increased airflow enhances the cooling of the product. The Output Current Derating graph found in the output section for each model provides the available output current vs. ambient air temperature and air velocity at $V_1=53$ V.

The product is tested on a 254 x 254 mm, 35 μ m (1 oz), 16-layer test board mounted vertically in a wind tunnel with a cross-section of 608 x 203 mm.

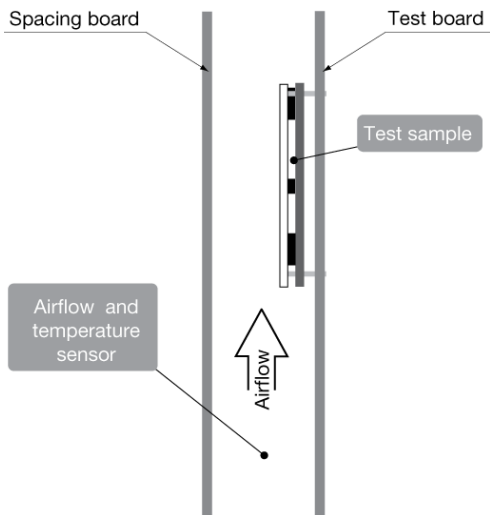

For products with base plate used in a sealed box/cold wall application, cooling is achieved mainly by conduction through the cold wall. The Output Current Derating graphs are found in the output section for each model. The product is tested in a sealed box test set up with ambient temperatures 85, 55 and 25°C. See Design Note 028 for further details.

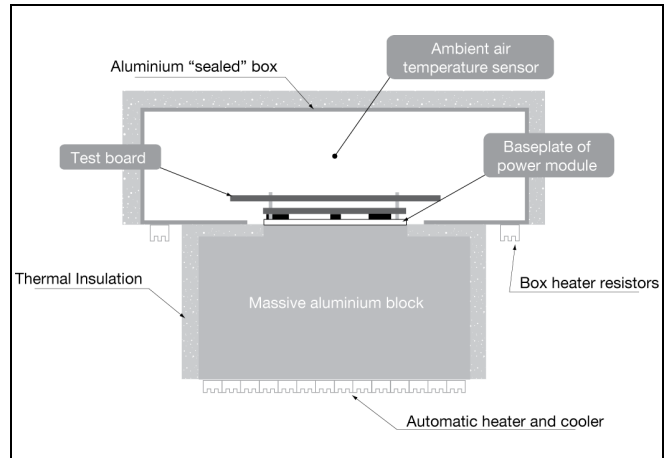

Definition of product operating temperature

The product operating temperature is used to monitor the temperature of the product, and proper thermal conditions can be verified by measuring the temperature at positions P1, P2, P3 and P4. The temperature at these positions (T_{P1} , T_{P2} , T_{P3} , T_{P4}) should not exceed the maximum temperatures in the table below. The number of measurement points may vary with different thermal design and topology. Temperatures above maximum T_{P1} , measured at the reference point P1 (T_{P3} / P3 for base plate versions) are not allowed and may cause permanent damage.

Position	Description	Max temperature
P1	PWB (reference point, open frame)	$T_{P1}=125^{\circ}$ C
P2	Opto-coupler	$T_{P2}=105^{\circ}$ C
P3	PWB (reference point for base-plate version)	$T_{P3}=125^{\circ}$ C
P4	Primary MOSFET	$T_{P4}=125^{\circ}$ C
P5	Baseplate	$T_{P5}=125^{\circ}$ C

BMR456 series Fully regulated Advanced Bus Converters
 Input 36-75 V, Output up to 39 A / 468 W

1/28701-FGC 101 1823 revG September 2017

© Flex

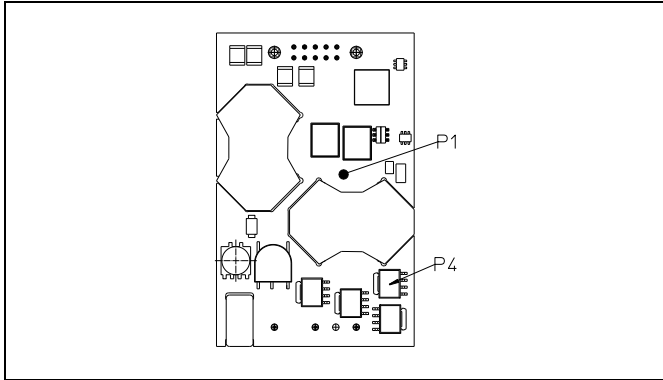

Open frame (Top View)

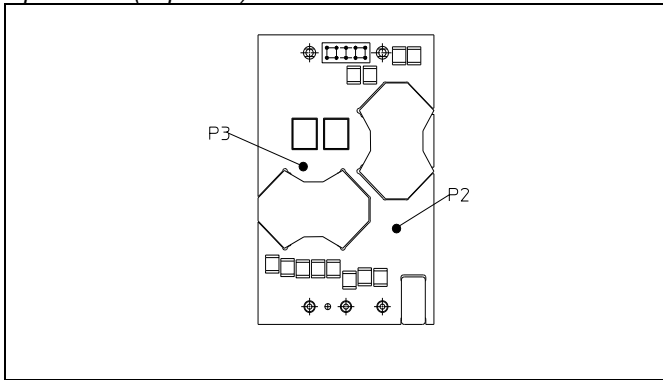

Base plate (Bottom View)

(Best air flow direction is from positive to negative pins.)

Ambient Temperature Calculation

For products with base plate the maximum allowed ambient temperature can be calculated by using the thermal resistance.

1. The power loss is calculated by using the formula
 $((1/\eta) - 1) \times \text{output power} = \text{power losses (Pd)}$
 $\eta = \text{efficiency of product. E.g. } 95\% = 0.95$

2. Find the thermal resistance (Rth) in the Thermal Resistance graph found in the Output section for each model. **Note that the thermal resistance can be significantly reduced if a heat sink is mounted on the top of the base plate.**

Calculate the temperature increase (ΔT).

$$\Delta T = R_{th} \times P_d$$

3. Max allowed ambient temperature is:

$$\text{Max } T_{P1} - \Delta T.$$

E.g. BMR 456 0100/002 at 2m/s:

$$1. ((\frac{1}{0.95}) - 1) \times 468 \text{ W} = 24.6 \text{ W}$$

$$2. 24.6 \text{ W} \times 2.8^\circ\text{C/W} = 69.0^\circ\text{C}$$

$$3. 125^\circ\text{C} - 69.0^\circ\text{C} = \text{max ambient temperature is } 56^\circ\text{C}$$

The actual temperature will be dependent on several factors such as the PWB size, number of layers and direction of airflow.

Connections (Top view)

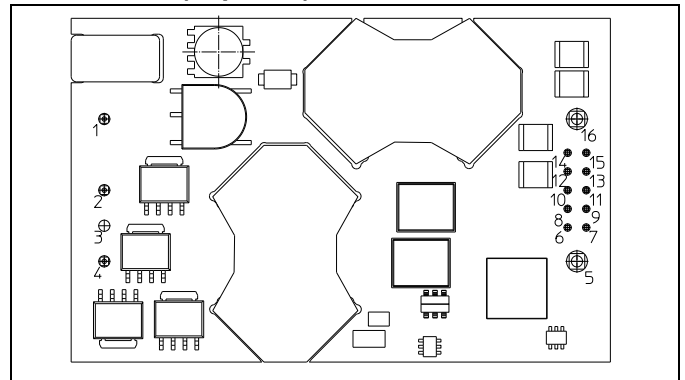

Pin	Designation	Function
1	+In	Positive Input
2	RC	Remote Control
3	Case	Case to GND (optional)
4	-In	Negative Input
5	-Out	Negative Output
6	S+	Positive Remote Sense
7	S-	Negative Remote Sense
8	SA0	Address pin 0
9	SA1	Address pin 1
10	SCL	PMBus Clock
11	SDA	PMBus Data
12	PG	Power Good output
13	DGND	PMBus ground
14	SALERT	PMBus alert signal
15	CTRL	PMBus remote control
16	+Out	Positive Output

BMR456 series Fully regulated Advanced Bus Converters
Input 36-75 V, Output up to 39 A / 468 W

1/28701-FGC 101 1823 revG September 2017
© Flex

PMBus Interface

This product provides a PMBus digital interface that enables the user to configure many aspects of the device operation as well as to monitor the input and output voltages, output current and device temperature. The product can be used with any standard two-wire I²C or SMBus host device. In addition, the product is compatible with PMBus version 1.2 and includes an SALERT line to help mitigate bandwidth limitations related to continuous fault monitoring. The product supports 100 kHz and 400 kHz bus clock frequency only. The PMBus signals, SCL, SDA and SALERT require passive pull-up resistors as stated in the SMBus Specification. Pull-up resistors are required to guarantee the rise time as follows:

$$\text{Eq. 7 } \tau = R_p C_p \leq 1\mu\text{s}$$

where R_p is the pull-up resistor value and C_p is the bus load. The maximum allowed bus load is 400 pF. The pull-up resistor should be tied to an external supply between 2.7 to 5.5 V, which should be present prior to or during power-up. If the proper power supply is not available, voltage dividers may be applied. Note that in this case, the resistance in the equation above corresponds to parallel connection of the resistors forming the voltage divider.

It is recommended to always use PEC (Packet Error Check) when communicating via PMBus. For these products it is a requirement to use PEC when using Send Byte to the device, for example command "RESTORE_DEFAULT_ALL".

Monitoring via PMBus

A system controller (host device) can monitor a wide variety of parameters through the PMBus interface. The controller can monitor fault conditions by monitoring the SALERT pin, which will be asserted when any number of pre-configured fault or warning conditions occur. The system controller can also continuously monitor any number of power conversion parameters including but not limited to the following:

- Input voltage
- Output voltage
- Output current
- Internal junction temperature
- Switching frequency (Monitors the set value not actual frequency)
- Duty cycle

Software Tools for Design and Production

For this products Flex provides software for configuring and monitoring via the PMBus interface. For more information please contact your local Flex sales representative.

PMBus Addressing

The following figure and table show recommended resistor values with min and max voltage range for hard-wiring PMBus addresses (series E12, 1% tolerance resistors suggested):

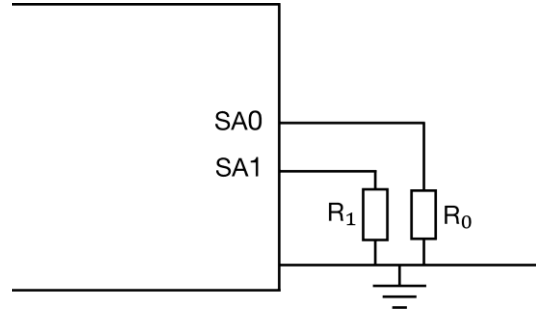

Schematic of connection of address resistors.

SA0/SA1 Index	R _{SA0} /R _{SA1} [kΩ]
0	10
1	22
2	33
3	47
4	68
5	100
6	150
7	220

The SA0 and SA1 pins can be configured with a resistor to GND according to the following equation.

$$\text{PMBus Address} = 8 \times (\text{SA0value}) + (\text{SA1 value})$$

If the calculated PMBus address is 0, 11 or 12, PMBus address 127 is assigned instead. From a system point of view, the user shall also be aware of further limitations of the addresses as stated in the PMBus Specification. It is not recommended to keep the SA0 and SA1 pins left open.

I²C/SMBus – Timing

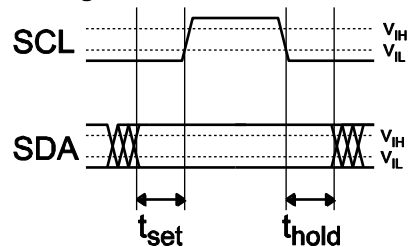

Setup and hold times timing diagram

The setup time, t_{set} , is the time data, SDA, must be stable before the rising edge of the clock signal, SCL. The hold time t_{hold} , is the time data, SDA, must be stable after the rising edge of the clock signal, SCL. If these times are violated incorrect data may be captured or meta-stability may occur and the bus communication may fail. When configuring the product, all standard SMBus protocols must be followed, including clock

BMR456 series Fully regulated Advanced Bus Converters
 Input 36-75 V, Output up to 39 A / 468 W

1/28701-FGC 101 1823 revG September 2017

© Flex

stretching. Additionally, a bus-free time delay between every SMBus transmission (between every stop & start condition) must occur. Refer to the SMBus specification, for SMBus electrical and timing requirements. Note that an additional delay of 5 ms has to be inserted in case of storing the RAM content into the internal non-volatile memory.

PMBus Commands

The products are PMBus compliant. The following table lists the implemented PMBus read commands. For more detailed information see PMBus Power System Management Protocol Specification; Part I – General Requirements, Transport and Electrical Interface and PMBus Power System Management Protocol; Part II – Command Language.

Designation	Cmd	Prot
Standard PMBus Commands		
Control Commands		
OPERATION	01h	No
ON_OFF_CONFIG	02h	No
WRITE_PROTECT	10h	No
Output Commands		
VOUT_MODE	20h	No
VOUT_COMMAND	21h	No
VOUT_TRIM	22h	No
VOUT_CAL_OFFSET	23h	Yes
VOUT_MAX	24h	No
VOUT_MARGIN_HIGH	25h	No
VOUT_MARGIN_LOW	26h	No
VOUT_TRANSITION_RATE	27h	No
VOUT_SCALE_LOOP	29h	Yes
VOUT_SCALE_MONITOR	2Ah	Yes
MAX_DUTY	32h	No
FREQUENCY_SWITCH	33h	No
VIN_ON	35h	No
VIN_OFF	36h	No
IOUT_CAL_GAIN	38h	Yes
IOUT_CAL_OFFSET	39h	Yes
Fault Commands		
VOUT_OV_FAULT_LIMIT	40h	No
VOUT_OV_FAULT_RESPONSE	41h	No
VOUT_OV_WARN_LIMIT	42h	No
VOUT_UV_WARN_LIMIT	43h	No
VOUT_UV_FAULT_LIMIT	44h	No
VOUT_UV_FAULT_RESPONSE	45h	No
IOUT_OC_FAULT_LIMIT	46h	No

Designation	Cmd	Prot
IOUT_OC_FAULT_RESPONSE	47h	No
IOUT_OC_LV_FAULT_LIMIT	48h	No
IOUT_OC_WARN_LIMIT	4Ah	No
OT_FAULT_LIMIT	4Fh	No
OT_FAULT_RESPONSE	50h	No
OT_WARN_LIMIT	51h	No
UT_WARN_LIMIT	52h	No
UT_FAULT_LIMIT	53h	No
UT_FAULT_RESPONSE	54h	No
VIN_OV_FAULT_LIMIT	55h	No
VIN_OV_FAULT_RESPONSE	56h	No
VIN_OV_WARN_LIMIT	57h	No
VIN_UV_WARN_LIMIT	58h	No
VIN_UV_FAULT_LIMIT	59h	No
VIN_UV_FAULT_RESPONSE	5Ah	No
POWER_GOOD_ON	5Eh	No
POWER_GOOD_OFF	5Fh	No
Time setting Commands		
TON_DELAY	60h	No
TON_RISE	61h	No
TON_MAX_FAULT_LIMIT	62h	No
TON_MAX_FAULT_RESPONSE	63h	No
TOFF_DELAY	64h	No
TOFF_FALL	65h	No
TOFF_MAX_WARN_LIMIT	66h	No
Status Commands (Read Only)		
CLEAR_FAULTS	03h	No
STATUS_BYTES	78h	No
STATUS_WORD	79h	No
STATUS_VOUT	7Ah	No
STATUS_IOUT	7Bh	No
STATUS_INPUT	7Ch	No
STATUS_TEMPERATURE	7Dh	No
STATUS_CML	7Eh	No
STATUS_OTHER	7Fh	No
Monitor Commands (Read Only)		
READ_VIN	88h	No
READ_VOUT	8Bh	No
READ_IOUT	8Ch	No
READ_TEMPERATURE_1	8Dh	No
READ_TEMPERATURE_2	8Eh	No
READ_DUTY_CYCLE	94h	No

BMR456 series Fully regulated Advanced Bus Converters
 Input 36-75 V, Output up to 39 A / 468 W

1/28701-FGC 101 1823 revG September 2017

© Flex

Designation	Cmd	Prot
READ_FREQUENCY	95h	No
Configuration and Control Commands		
USER_DATA_00	B0h	No
Identification Commands (Read Only)		
PMBUS_REVISION	98h	No
MFR_ID	99h	Yes
MFR_MODEL	9Ah	Yes
MFR_REVISION	9Bh	Yes
MFR_LOCATION	9Ch	Yes
MFR_DATE	9Dh	Yes
MFR_SERIAL	9Eh	Yes
Supervisory Commands		
STORE_DEFAULT_ALL	11h	Yes
RESTORE_DEFAULT_ALL	12h	No
STORE_USER_ALL	15h	No
RESTORE_USER_ALL	16h	No
CAPABILITY	19h	No
Product Specific Commands		
MFR_POWER_GOOD_POLARITY	D0h	No
MFR_VIN_SCALE_MONITOR	D3h	Yes
MFR_SELECT_TEMP_SENSOR	DCh	No
MFR_VIN_OFFSET	DDh	Yes
MFR_VOUT_OFFSET_MONITOR	DEh	Yes
MFR_TEMP_OFFSET_INT	E1h	No
MFR_REMOTE_TEMP_CAL	E2h	No
MFR_REMOTE_CTRL	E3h	No
MFR_DEAD_BAND_DELAY	E5h	Yes
MFR_TEMP_COEFF	E7h	Yes
MFR_DEBUG_BUFF	F0h	No
MFR_SETUP_PASSWORD	F1h	No
MFR_DISABLE_SECURITY_ONCE	F2h	No
MFR_DEAD_BAND_IOUT_THRESHOLD	F3h	Yes
MFR_SECURITY_BIT_MASK	F4h	Yes
MFR_PRIMARY_TURN	F5h	Yes
MFR_SECONDARY_TURN	F6h	Yes
MFR_ILIM_SOFTSTART	F8h	No
MFR_MULTI_PIN_CONFIG	F9h	No
MFR_DEAD_BAND_VIN_THRESHOLD	FAh	Yes
MFR_DEAD_BAND_VIN_IOUT_HYS	FBh	Yes
MFR_RESTART	FEh	No

Notes:

Cmd, is short for Command.

Prot, is short for commands that are protected with security mask.

BMR456 series Fully regulated Advanced Bus Converters
 Input 36-75 V, Output up to 39 A / 468 W

1/28701-FGC 101 1823 revG September 2017

© Flex

Mechanical Information - Hole Mount, Open Frame Version

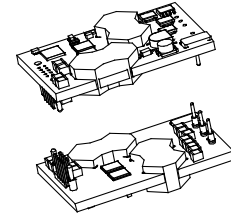
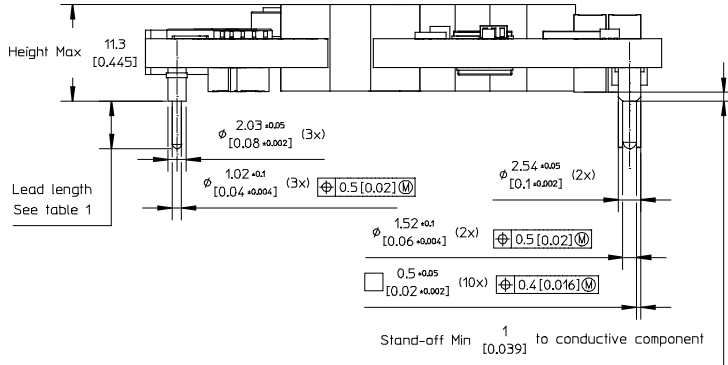

TOP VIEW

Pin positions according to recommended footprint

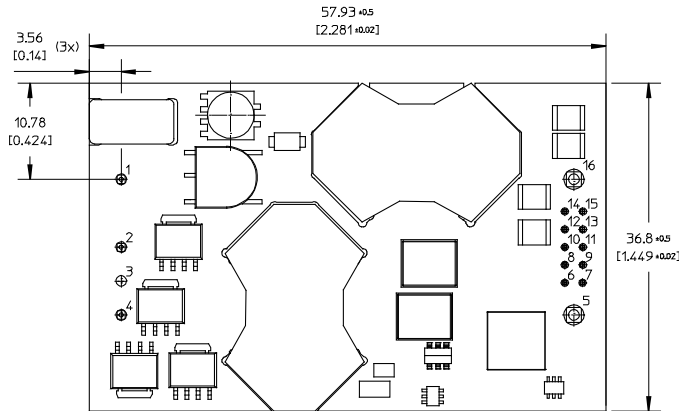

X1	Lead length
0	5.33 [0.210]
2	3.69 [0.145]
3	4.57 [0.180]
4	2.79 [0.110]

Table 1.
 X1 = Ordering Information

PIN SPECIFICATIONS
 Pin 1,2,4,5 & 16 Material: Copper alloy
 Plating: Min Au 0.1 μm over 1-3 μm Ni.
 Pin 6-15 Material: Brass
 Plating: Min Au 0.2 μm over 1.3 μm Ni.

NOTE
 Pin 6-15 are optional and only used if digital communication is required.

Position 3 is only used for base plate GND connection pin which is not available on this module.

RECOMMENDED FOOTPRINT - TOP VIEW

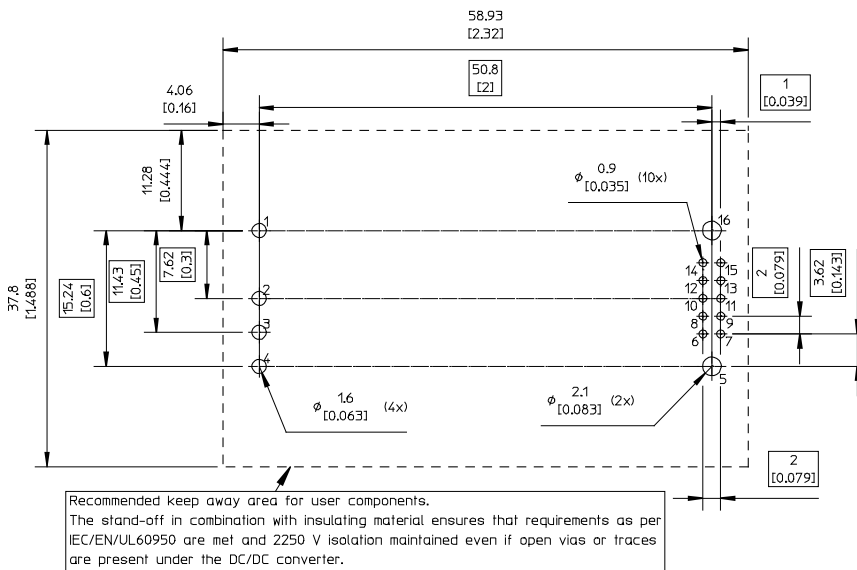

Weight: Typical 48 g
 All dimensions in mm [inch].
 Tolerances unless specified:
 x.x ± 0.50 [0.02], x.xx ± 0.25 [0.01]
 (not applied on footprint or typical values)



BMR456 series Fully regulated Advanced Bus Converters
 Input 36-75 V, Output up to 39 A / 468 W

1/28701-FGC 101 1823 revG September 2017
 © Flex

Mechanical Information - Hole Mount, Base Plate Version

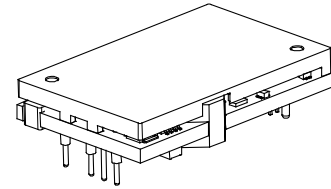
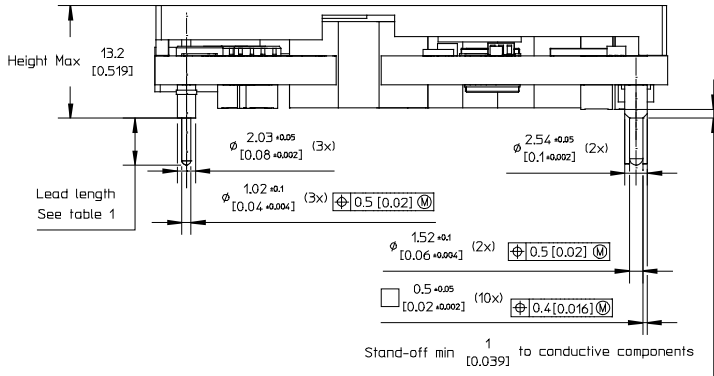

TOP VIEW

Pin positions according to recommended footprint

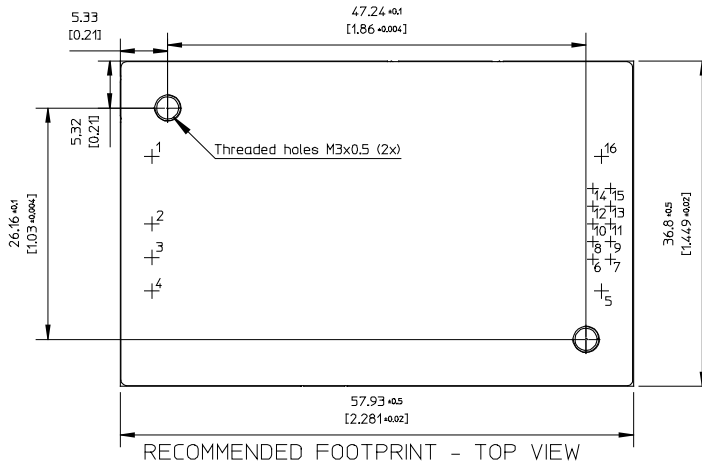

X1	Lead length
0	5.33 [0,210]
2	3.69 [0,145]
3	4.57 [0,180]
4	2.79 [0,110]

Table 1.
 X1 = Ordering information

CASE
 Material: Aluminium
 For screw attachment apply mounting torque of max 0.44 Nm [3.9 lbf in], M3 screws must not protrude more than 2.7 mm [0.106] into the base plate..

PIN SPECIFICATIONS
 Pin 1,2,3,4,5 & 16 Material: Copper Alloy
 Plating: Min Au 0.1 μ m over 1-3 μ m Ni.
 Pin 6-15 Material: Brass
 Plating: Min Au 0.2 μ m over 1-3 μ m Ni.

NOTE
 Pin 6-15 are optional and only used if digital communication is requested.
 Pin 3 is only used for baseplate GND connection.

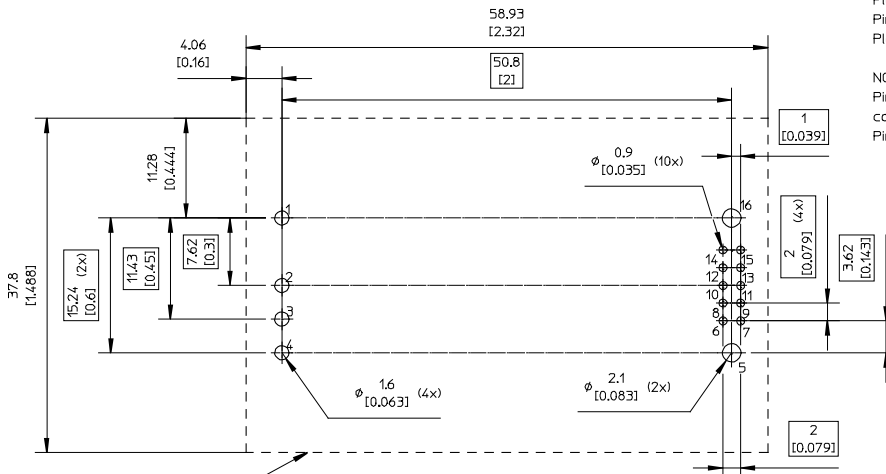

Weight: Typical 68 g
 All dimensions in mm [inch]
 Tolerances unless specified:
 x.x \pm 0.50 [0,02], x.xx \pm 0.25 [0,01]
 (not applied on footprint or typical values)

BMR456 series Fully regulated Advanced Bus Converters
 Input 36-75 V, Output up to 39 A / 468 W

1/28701-FGC 101 1823 revG September 2017

© Flex

Mechanical Information - Surface Mount Version

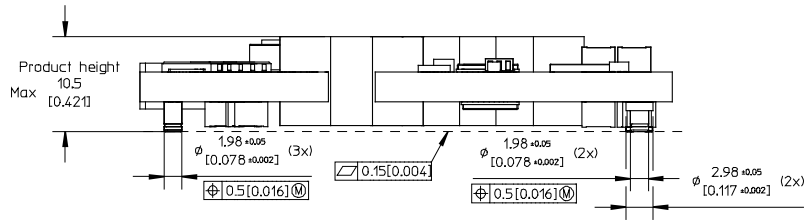
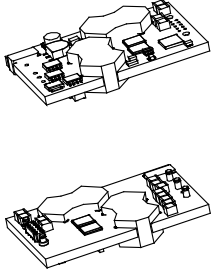

TOP VIEW

Pin positions according to recommended footprint

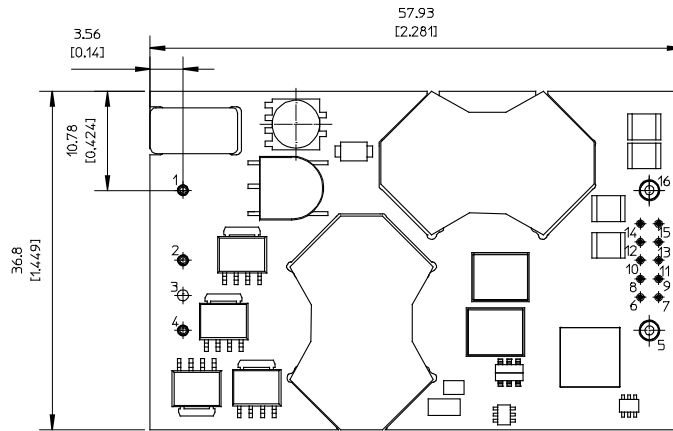
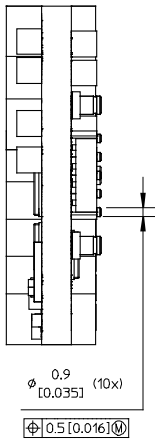

RECOMMENDED FOOTPRINT - TOP VIEW

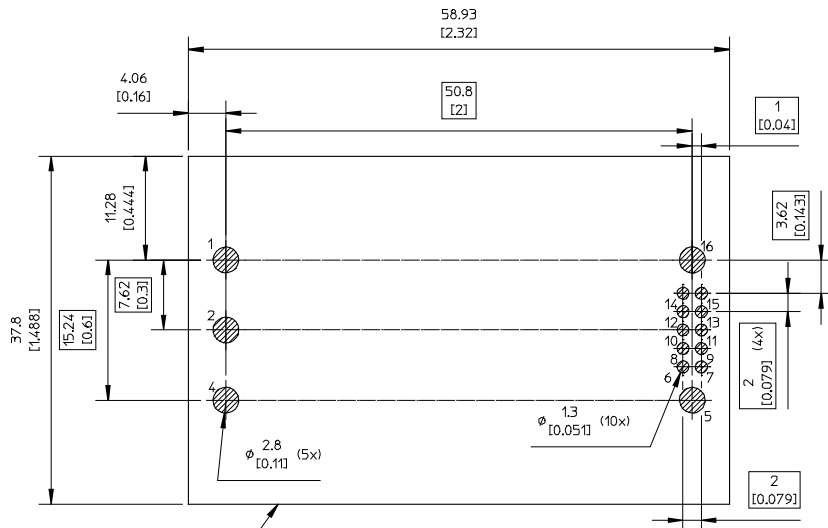

NOTES

PIN SPECIFICATIONS

Pin 1,2,4,5 & 16 - Material: Copper alloy
 Plating: Au 0.1 µm over 1-3 µm Ni.
 Pin 6-15 - Material: Brass
 Plating: Au 0.1 µm over 2 µm Ni.

Weight: Typical 46 g

All dimensions in mm [inch].
 Tolerances unless specified:
 x.x ±0.5 mm [0.02]
 x.xx ±0.25 mm [0.01]
 (not applied on footprint or typical values)



Recommended keep away area for user components.
 The stand-off in combination with insulating material ensures that requirements as per IEC/EN/UL60950 are met and 2250 V isolation maintained even if open vias or traces are present under the DC/DC converter.

BMR456 series Fully regulated Advanced Bus Converters
Input 36-75 V, Output up to 39 A / 468 W

1/28701-FGC 101 1823 revG September 2017

© Flex

Soldering Information – SMD Version / Hole Mount through Pin in Paste Assembly

The pin-in-paste (“E” option) and surface mount products are intended for forced convection or vapor phase reflow soldering in SnPb and Pb-free processes.

The reflow profile should be optimised to avoid excessive heating of the product. It is recommended to have a sufficiently extended preheat time to ensure an even temperature across the host PWB and it is also recommended to minimize the time in reflow.

A no-clean flux is recommended to avoid entrapment of cleaning fluids in cavities inside the product or between the product and the host board, since cleaning residues may affect long time reliability and isolation voltage.

General reflow process specifications		SnPb eutectic	Pb-free
Average ramp-up ($T_{PRODUCT}$)		3°C/s max	3°C/s max
Typical solder melting (liquidus) temperature	T_L	183°C	221°C
Minimum reflow time above T_L		60 s	60 s
Minimum pin temperature	T_{PIN}	210°C	235°C
Peak product temperature	$T_{PRODUCT}$	225°C	260°C
Average ramp-down ($T_{PRODUCT}$)		6°C/s max	6°C/s max
Maximum time 25°C to peak		6 minutes	8 minutes

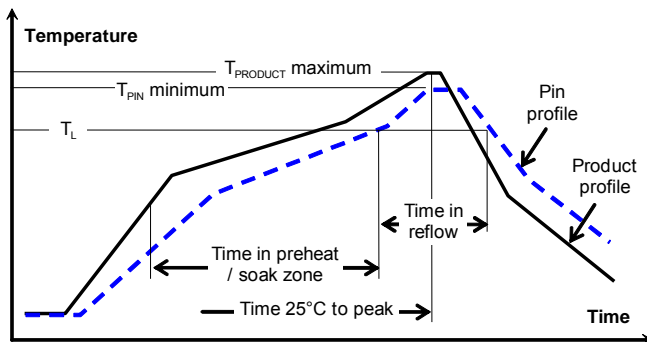

Minimum Pin Temperature Recommendations

Pin number 5 chosen as reference location for the minimum pin temperature recommendation since this will likely be the coolest solder joint during the reflow process.

SnPb solder processes

For SnPb solder processes, a pin temperature (T_{PIN}) in excess of the solder melting temperature, (T_L , 183°C for Sn63Pb37) for more than 60 seconds and a peak temperature of 220°C is recommended to ensure a reliable solder joint.

For dry packed products only: depending on the type of solder paste and flux system used on the host board, up to a recommended maximum temperature of 245°C could be used, if the products are kept in a controlled environment (dry pack handling and storage) prior to assembly.

Lead-free (Pb-free) solder processes

For Pb-free solder processes, a pin temperature (T_{PIN}) in excess of the solder melting temperature (T_L , 217 to 221°C for SnAgCu solder alloys) for more than 60 seconds and a peak temperature of 245°C on all solder joints is recommended to ensure a reliable solder joint.

Maximum Product Temperature Requirements

Top of the product PWB near pin 2 is chosen as reference location for the maximum (peak) allowed product temperature ($T_{PRODUCT}$) since this will likely be the warmest part of the product during the reflow process.

SnPb solder processes

For SnPb solder processes, the product is qualified for MSL 1 according to IPC/JEDEC standard J-STD-020C.

During reflow $T_{PRODUCT}$ must not exceed 225 °C at any time.

Pb-free solder processes

For Pb-free solder processes, the product is qualified for MSL 3 according to IPC/JEDEC standard J-STD-020C.

During reflow $T_{PRODUCT}$ must not exceed 260 °C at any time.

Dry Pack Information

Products intended for Pb-free reflow soldering processes are delivered in standard moisture barrier bags according to IPC/JEDEC standard.

Using products in high temperature Pb-free soldering processes requires dry pack storage and handling. In case the products have been stored in an uncontrolled environment and no longer can be considered dry, the modules must be baked according to J-STD-033.

Thermocouple Attachment

Top of PWB near pin 2 for measurement of maximum product temperature, $T_{PRODUCT}$

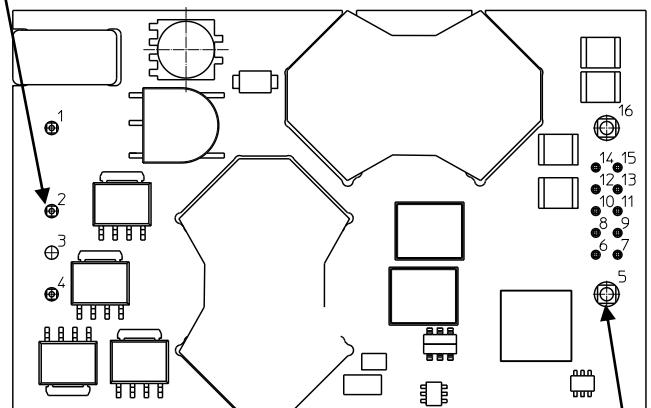

Pin 5 for measurement of minimum pin (solder joint) temperature, T_{PIN}

BMR456 series Fully regulated Advanced Bus Converters
 Input 36-75 V, Output up to 39 A / 468 W

1/28701-FGC 101 1823 revG September 2017

© Flex

Soldering Information - Hole Mounting

The hole mounted product is intended for plated through hole mounting by wave or manual soldering. The pin temperature is specified to maximum to 270°C for maximum 10 seconds.

A maximum preheat rate of 4°C/s and maximum preheat temperature of 150°C is suggested. When soldering by hand, care should be taken to avoid direct contact between the hot soldering iron tip and the pins for more than a few seconds in order to prevent overheating.

A no-clean flux is recommended to avoid entrapment of cleaning fluids in cavities inside the product or between the product and the host board. The cleaning residues may affect long time reliability and isolation voltage.

Delivery Package Information

The products are delivered in antistatic injection molded trays (Jedec design guide 4.10D standard) and in antistatic trays.

Tray Specifications – SMD Version with dry pack	
Material	Antistatic PPE
Surface resistance	$10^5 < \text{Ohm/square} < 10^{11}$
Bakability	The trays can be baked at maximum 125°C for 48 hours
Tray thickness	14.50 mm 0.571 [inch]
Box capacity	20 products (2 full trays/box)
Tray weight	125 g empty, 574 g full tray

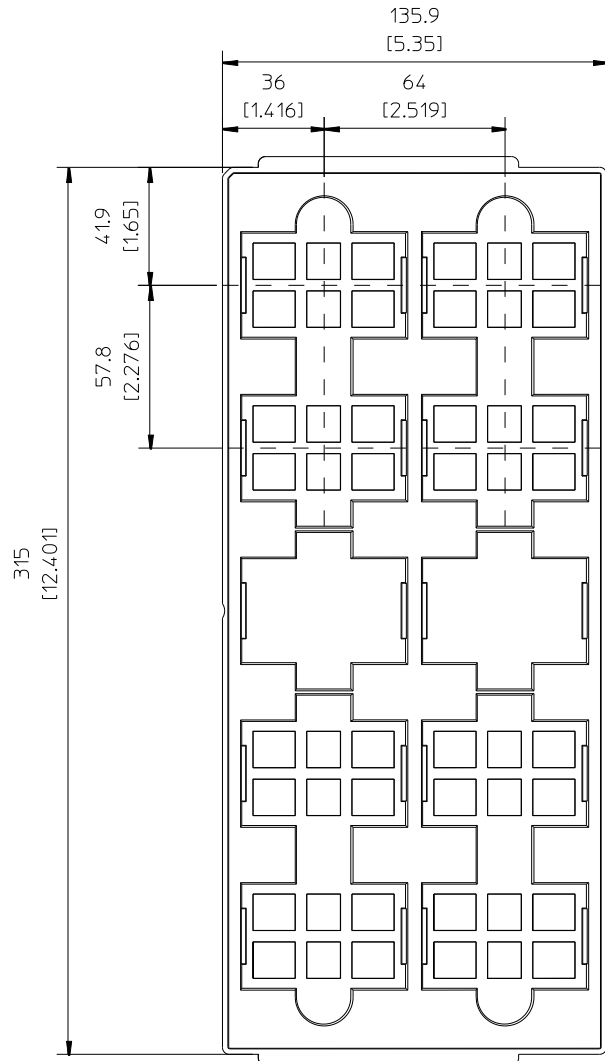

JEDEC standard tray for 2x5 = 10 products.

All dimensions in mm [inch]

Tolerances: X.x ±0.26 [0.01], X.xx ±0.13 [0.005]

Note: pick up positions refer to center of pocket.

See mechanical drawing for exact location on product.

BMR456 series Fully regulated Advanced Bus Converters
Input 36-75 V, Output up to 39 A / 468 W

1/28701-FGC 101 1823 revG September 2017

© Flex

Tray Specifications – Through hole version without dry pack

Material	PE Foam
Surface resistance	$10^5 < \text{Ohm/square} < 10^{11}$
Bakability	The trays cannot be baked
Tray capacity	20 converters/tray
Box capacity	Open frame and baseplate version -60 products (3 full trays/box)
Tray Weight	Product – Open frame 1100 g full tray, 140g empty tray Product – Base plate option 1480 g full tray, 140 g empty tray

Tray Specifications – Through hole version with dry pack

Material	Antistatic Polystyrene (black)
Surface resistance	$10^5 < \text{Ohm/square} < 10^{11}$
Bakability	The tray cannot be baked
Tray thickness	25 mm 0.984 [inch]
Box capacity	48 products (4 full trays/box)
Tray weight	Product – Open frame version 632 g full tray, 56 g empty tray Product – Base plate option 862 g full tray, 58 g empty tray

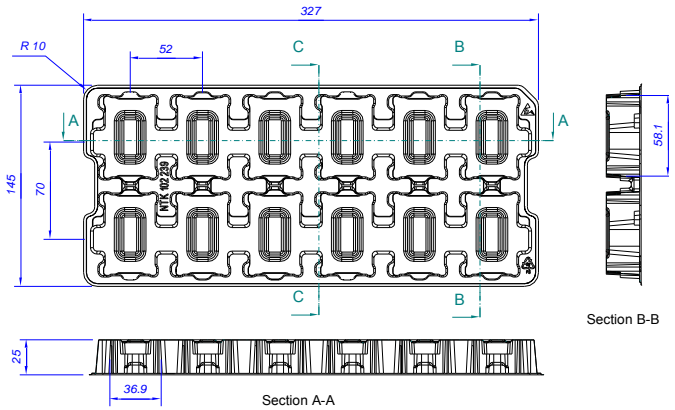
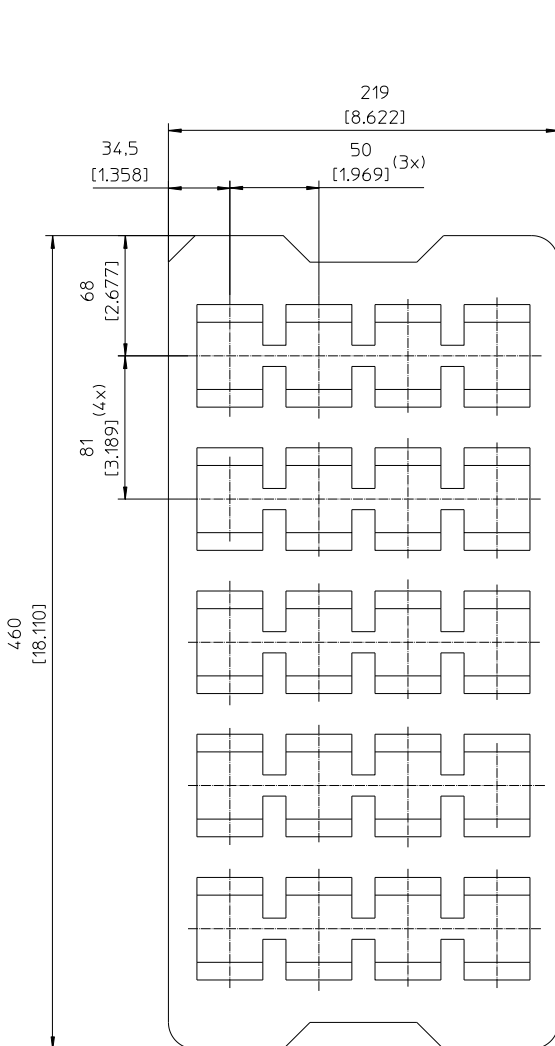

All dimensions in mm [inch]
Tolerances: X.x ± 0.26 [0.01], X.xx ± 0.13 [0.005]
Note: The tray is not designed for machine pick up

BMR456 series Fully regulated Advanced Bus Converters
 Input 36-75 V, Output up to 39 A / 468 W

1/28701-FGC 101 1823 revG September 2017

© Flex

Product Qualification Specification

Characteristics			
External visual inspection	IPC-A-610		
Change of temperature (Temperature cycling)	IEC 60068-2-14 Na	Temperature range Number of cycles Dwell/transfer time	-40 to 100°C 500 15 min/0-1 min
Cold (in operation)	IEC 60068-2-1 Ad	Temperature T _A Duration	-45°C 72 h
Damp heat	IEC 60068-2-67 Cy	Temperature Humidity Duration	85°C 85 % RH 1000 hours
Dry heat	IEC 60068-2-2 Bd	Temperature Duration	125°C 1000 h
Electrostatic discharge susceptibility	IEC 61340-3-1, JESD 22-A114 IEC 61340-3-2, JESD 22-A115	Human body model (HBM) Machine Model (MM)	Class 2, 2000 V Class 3, 200 V
Immersion in cleaning solvents	IEC 60068-2-45 XA, method 2	Water Glycol ether Isopropyl alcohol	55°C 35°C 35°C
Mechanical shock	IEC 60068-2-27 Ea	Peak acceleration Duration	100 g 6 ms
Moisture reflow sensitivity ¹	J-STD-020C	Level 1 (SnPb-eutectic) Level 3 (Pb Free)	225°C 260°C
Operational life test	MIL-STD-202G, method 108A	Duration	1000 h
Resistance to soldering heat ²	IEC 60068-2-20 Tb, method 1A	Solder temperature Duration	270°C 10-13 s
Robustness of terminations	IEC 60068-2-21 Test Ua1 IEC 60068-2-21 Test Ue1	Through hole mount products Surface mount products	All leads All leads
Solderability	IEC 60068-2-58 test Td ¹	Preconditioning Temperature, SnPb Eutectic Temperature, Pb-free	150°C dry bake 16 h 215°C 235°C
	IEC 60068-2-20 test Ta ²	Preconditioning Temperature, SnPb Eutectic Temperature, Pb-free	Steam ageing 235°C 245°C
Vibration, broad band random	IEC 60068-2-64 Fh, method 1	Frequency Spectral density Duration	10 to 500 Hz 0.07 g ² /Hz 10 min in each direction

Notes

¹ Only for products intended for reflow soldering (pin-in-paste and surface mount products)

² Only for products intended for wave soldering (plated through hole products)



Компания «ЭлектроПласт» предлагает заключение долгосрочных отношений при поставках импортных электронных компонентов на взаимовыгодных условиях!

Наши преимущества:

- Оперативные поставки широкого спектра электронных компонентов отечественного и импортного производства напрямую от производителей и с крупнейших мировых складов;
- Поставка более 17-ти миллионов наименований электронных компонентов;
- Поставка сложных, дефицитных, либо снятых с производства позиций;
- Оперативные сроки поставки под заказ (от 5 рабочих дней);
- Экспресс доставка в любую точку России;
- Техническая поддержка проекта, помощь в подборе аналогов, поставка прототипов;
- Система менеджмента качества сертифицирована по Международному стандарту ISO 9001;
- Лицензия ФСБ на осуществление работ с использованием сведений, составляющих государственную тайну;
- Поставка специализированных компонентов (Xilinx, Altera, Analog Devices, Intersil, Interpoint, Microsemi, Aeroflex, Peregrine, Syfer, Eurofarad, Texas Instrument, Miteq, Cobham, E2V, MA-COM, Hittite, Mini-Circuits, General Dynamics и др.);

Помимо этого, одним из направлений компании «ЭлектроПласт» является направление «Источники питания». Мы предлагаем Вам помощь Конструкторского отдела:

- Подбор оптимального решения, техническое обоснование при выборе компонента;
- Подбор аналогов;
- Консультации по применению компонента;
- Поставка образцов и прототипов;
- Техническая поддержка проекта;
- Защита от снятия компонента с производства.



Как с нами связаться

Телефон: 8 (812) 309 58 32 (многоканальный)

Факс: 8 (812) 320-02-42

Электронная почта: org@eplast1.ru

Адрес: 198099, г. Санкт-Петербург, ул. Калинина, дом 2, корпус 4, литера А.