

EMA212 Series



- 3.00" x 5.00" x 1.34"
- High Power Density 10.6 W/in³
- Up to 90% Efficiency
- 5 V Standby & 12 V Fan Outputs
- Active Current Share
- Remote On/Off
- Power Good Signal
- -10 °C to +70 °C Operation
- Universal AC Input 90–264 VAC
- Level B Conducted Emissions
- 48 VDC Input Versions Available (DMA212)

Designed for communications applications, the EMA212 has been developed to meet the needs of networking equipment, voice over IP systems, wireless LANs, servers, storage area networks and post-production broadcast equipment. Designers of these systems demand higher power from AC/DC units in industry-standard 1U formats as processing power and functionality grows within tight space constraints. The EMA212 delivers over 200W across the full universal AC input range from an industry-standard 3 x 5 inch (76.2 x 127 mm) footprint. It is 1.34 inches (34.04 mm) high and achieves 10.6 Watts per cubic inch power density without compromising performance or functionality.

With efficiency up to 90% at full load, the EMA212 needs only 12 CFM air-flow for full power operation at up to 50 °C ambient and will operate at up to 70 °C ambient with de-rating. The main output is 12, 24 or 48 VDC but each power supply also has a 5 V, 100 mA standby output and a 12 V, 1 A output for powering a fan. The unit incorporates a fully featured signal set including AC fail/DC OK, remote on/off and active current sharing.

Models and Ratings

Max Output Power (12 CFM Air Flow)	Output Voltage V1	Output Current (12 CFM Airflow)	Fan Output V2	Standby Supply V3	Model Number
212 W	12.0VDC	16.7 A	12.0 V/1.0 A	5.0 V/0.1 A	EMA212PS12
212 W	24.0VDC	8.3 A	12.0 V/1.0 A	5.0 V/0.1 A	EMA212PS24
205 W	48.0VDC	4.0 A	12.0 V/1.0 A	5.0 V/0.1 A	EMA212PS48

Input Characteristics

Characteristic	Minimum	Typical	Maximum	Units	Notes & Conditions
Input Voltage - Operating	90		264	VAC	
Input Frequency	47	50/60	63	Hz	
Power Factor		>0.9			230 VAC
Input Current - No Load		110		mA	
Input Current - Full Load		2.1/1.1		A	115/230 VAC
Inrush Current			60	A	230 VAC cold start
Earth Leakage Current		0.5	1.1	mA	230/264 VAC 50 Hz
Input Protection	T5 A/250 V internal fuse in line				

Output Characteristics

Characteristic	Minimum	Typical	Maximum	Units	Notes & Conditions
Output Voltage - V1	12		48	VDC	See Models and Ratings table
Initial Set Accuracy			$\pm 1^{(V1)}$, $\pm 5^{(V2)}$ & $\pm 3^{(V3)}$	%	
Output Voltage Adjustment					Not available
Minimum Load					No minimum load required
Start Up Delay		1.5	3	s	90 VAC full load (see fig. 1 to 3)
Start Up Rise Time			20	ms	
Hold Up Time	16	20		ms	90 VAC full load (see fig. 4 to 6)
Drift			± 0.2	%	After 20 min warm up
Line Regulation			$\pm 0.5^{(V1)}$, $\pm 2^{(V2)}$ & $\pm 0.5^{(V3)}$	%	
Load Regulation			$\pm 1^{(V1)}$, $\pm 5^{(V2)}$ & $\pm 1^{(V3)}$	%	0-100% load V1 & V3, 10-100% load V2
Cross Regulation			$\pm 10^{(V2)}$	%	10-100% load change V1
Transient Response - V1			4	%	Recovery within 1% in less than 500 μ s for a 25-75% and 75-25% load step (see fig. 7 & 8)
Over/Undershoot - V1			2/5	%	12/48 V (see fig. 9)
Ripple & Noise			$1^{(V1)}$ & $^{(V3)}$ & $2^{(V2)}$	% pk-pk	20 MHz bandwidth (see fig. 11 to 14)
Overvoltage Protection	115		140	%	Vnom DC. Output 1 only, recycle input to reset
Overload Protection	110		140	% I nom	Output 1 only, auto reset (see fig. 10)
Short Circuit Protection					Trip & Restart (Hiccup mode)
Temperature Coefficient			0.05	%/°C	
Overtemperature Protection				°C	Primary & secondary protection

Start Up Delay From AC Turn On

- KEY
- ① AC
 - ② V1
 - ③ V FAN V2
 - ④ V STANDBY V3

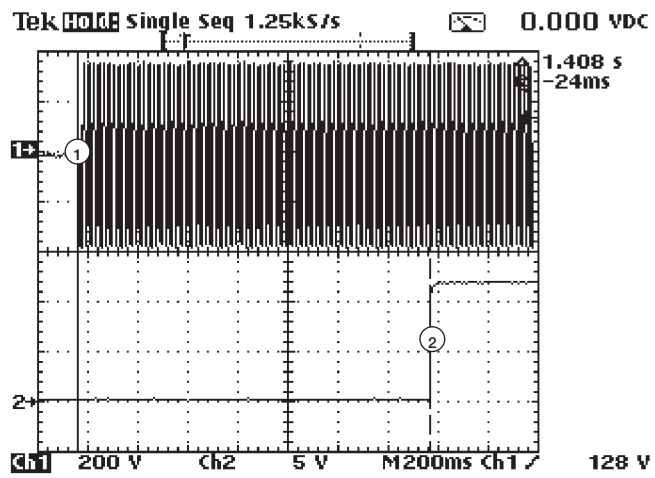

Figure 1
V1 (full load) - 1.40 s

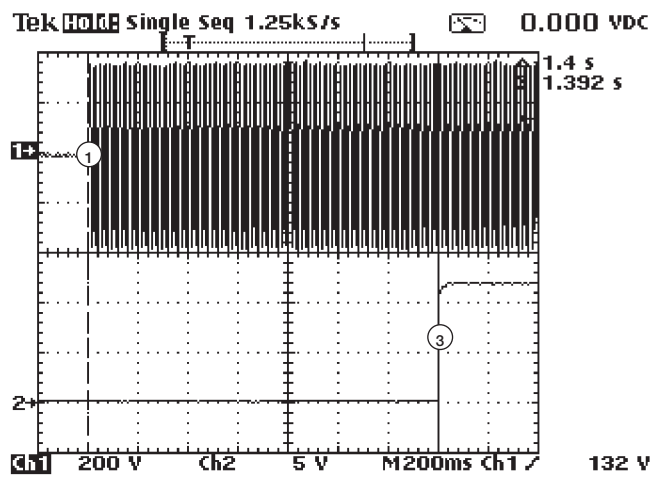

Figure 2
V2 (full load) - 1.45 s

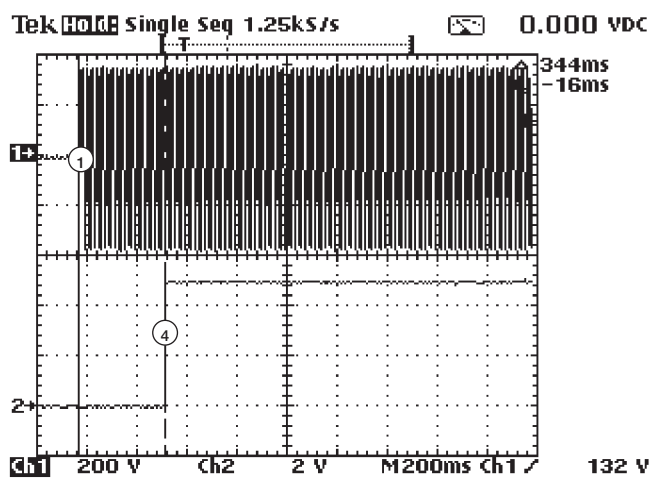

Figure 3
V3 (full load) - 344 ms

Hold Up Time From Loss Of AC

KEY
 ① AC

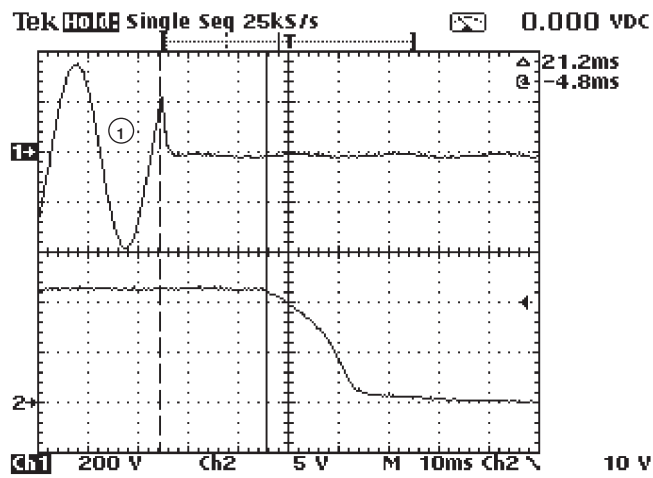

Figure 4

V1 21.2 ms (Full load at 90 VAC input)

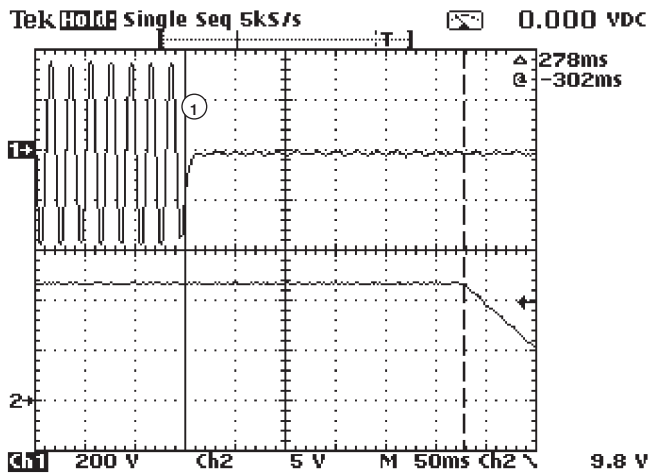

Figure 5

V2 278 ms (Full load at 90 VAC input)

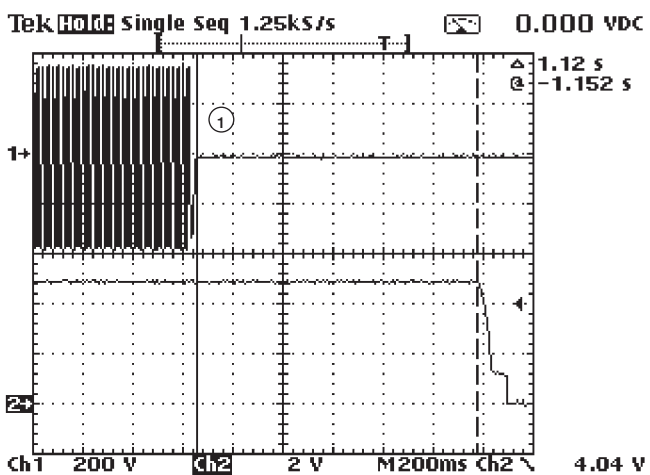

Figure 6

V3 1.12 s (Full load at 90 VAC input)

Output Transient Response 25-75% & 75-25% Load Step

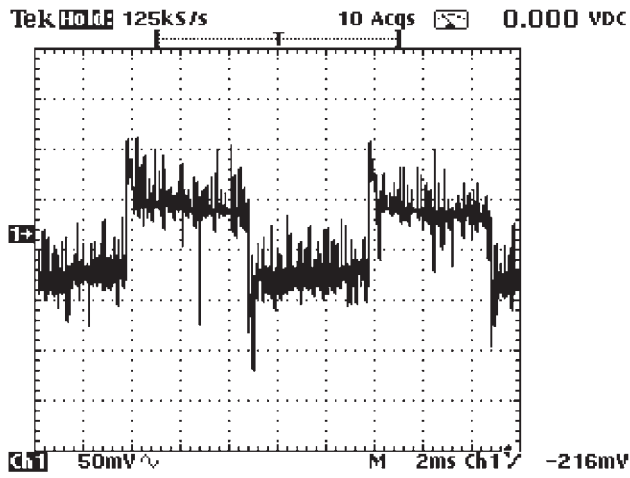

Figure 7
EMA212PS12

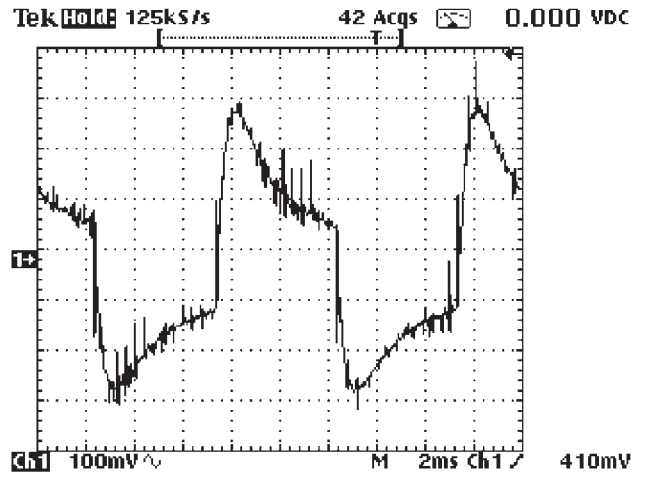

Figure 8
EMA212PS48

Output Overshoot

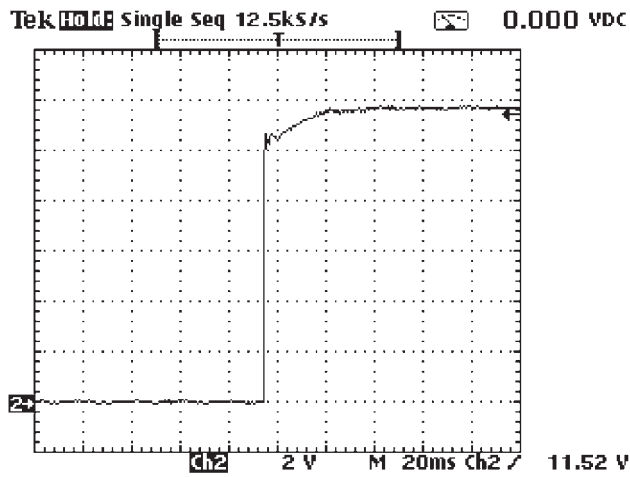

Figure 9
Typical Output Overshoot

Output Overload Characteristic

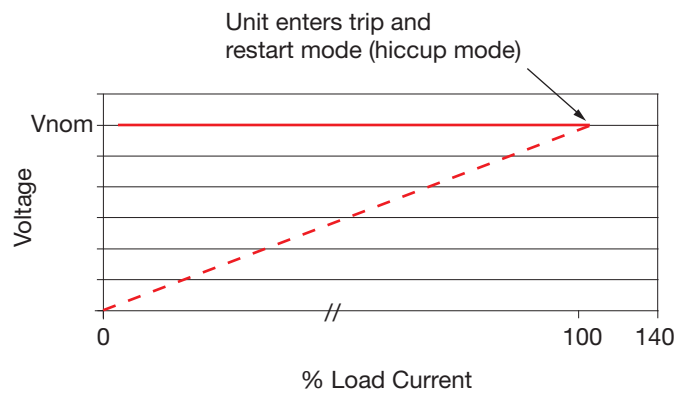

Figure 10
Typical Overload Characteristic

Output Ripple & Noise

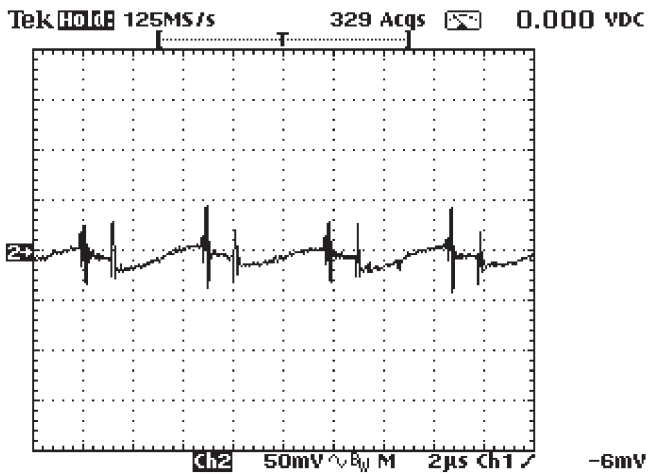

Figure 11
V1 EMA212PS12 (Full load).
80 mV pk-pk Ripple. 20 MHz BW

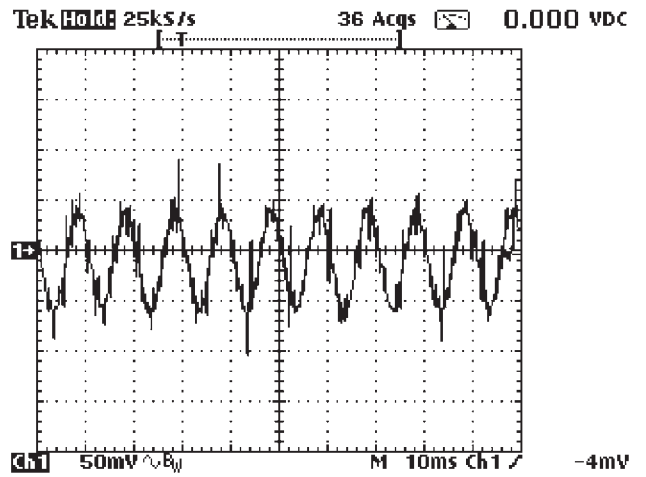

Figure 12
V1 EMA212PS48 (Full load).
180 mV pk-pk Ripple. 20 MHz BW

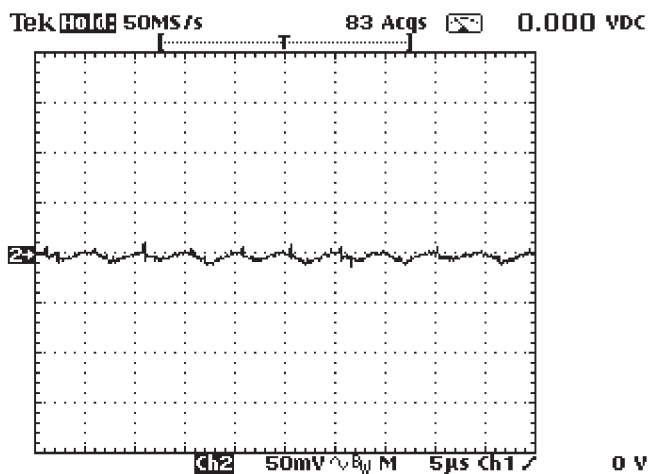

Figure 13
V2 (Full load).
< 25 mV pk-pk Ripple. 20 MHz BW

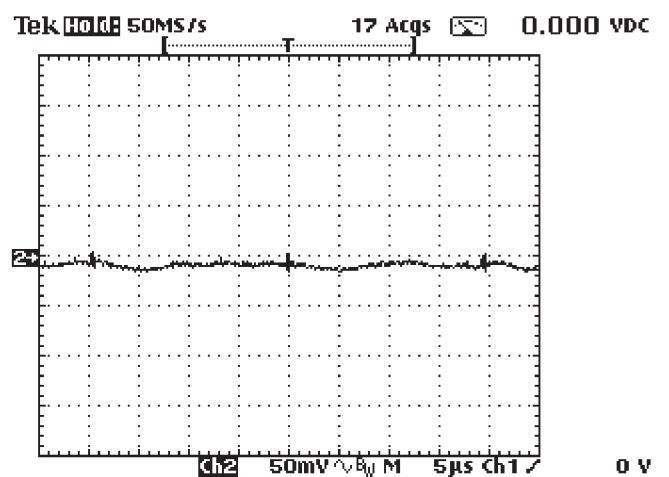

Figure 14
V3 (Full load).
< 25 mV pk-pk Ripple. 20 MHz BW

General Specifications

Characteristic	Minimum	Typical	Maximum	Units	Notes & Conditions
Efficiency		88		%	Full load 230 VAC (see fig. 15 & 16)
Isolation: Input to Output Input to Ground Output to Ground	3000			VAC	
	1500			VAC	
	500			VDC	
Switching Frequency: PFC Main Converter		80		kHz	
		100		kHz	
Power Density			10.6	W/in ³	
Mean Time Between Failure		212		kHrs	MIL-HDBK-217F, ground benign at 25°C.
Weight			0.66 (300)	lb (g)	

Characteristic	Notes & Conditions
Signals	
Combined Power Fail & DC OK	Open collector referenced to output 0V, transistor normally off when AC & output good. Power Fail: Provides ≥ 5 ms warning of loss of output from AC failure. DC OK: Provides warning of DC output failure (see fig. 17 to fig 27)
Remote On/Off	Uncommitted isolated opto-coupler diode - powered diode inhibits the supply.
Current Share	For increased power, up to 3 supplies can be connected in parallel. Output current is shared within 10% at full load. Derate to 90%. The current share function is not designed to offer redundant operation.

Efficiency Versus Load

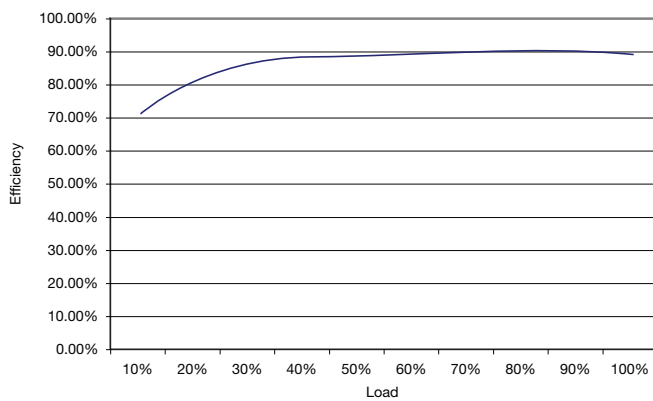

Figure 15
EMA212PS12

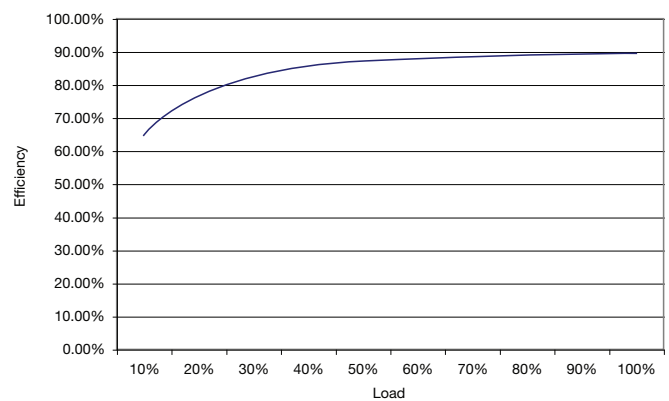
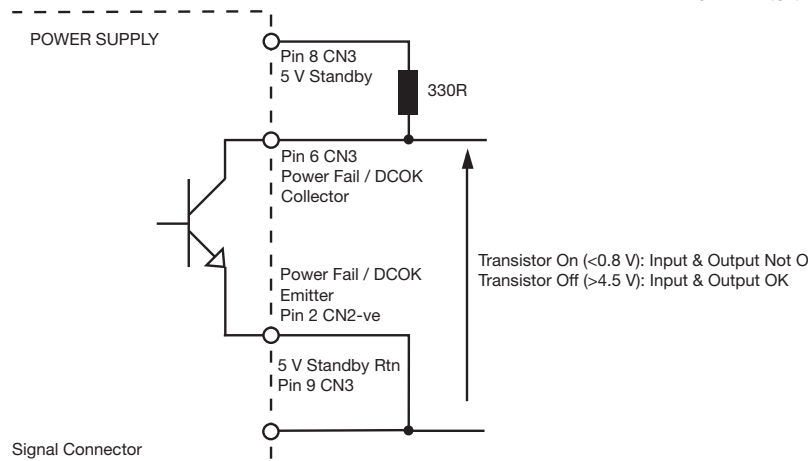

Figure 16
EMA212PS48

Combined Power Fail & DC OK Signal



Remote On/Off

Signal is an isolated control signal which can turn the PSU off by supplying 5 mA into the pin.

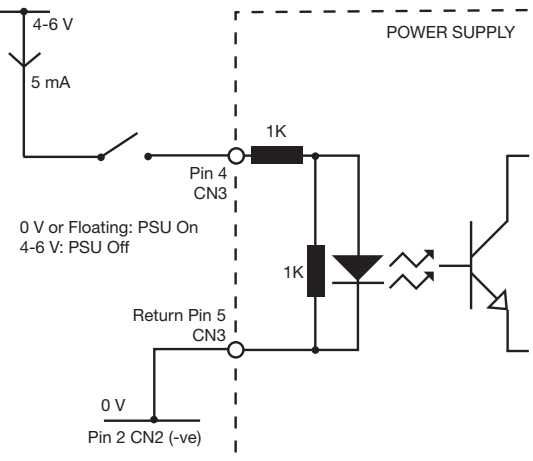

Figure 17

Signals

KEY
 ① AC
 ② Comined Power Fail & DC OK Signal

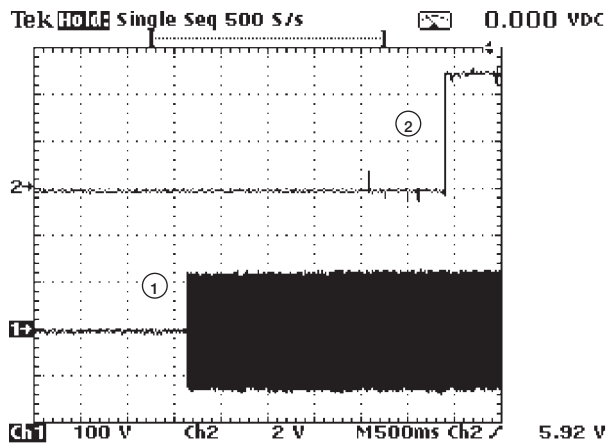

Figure 18
 PF & DC OK signal 'V' AC switch on
 90 VAC full load - 2.8 seconds

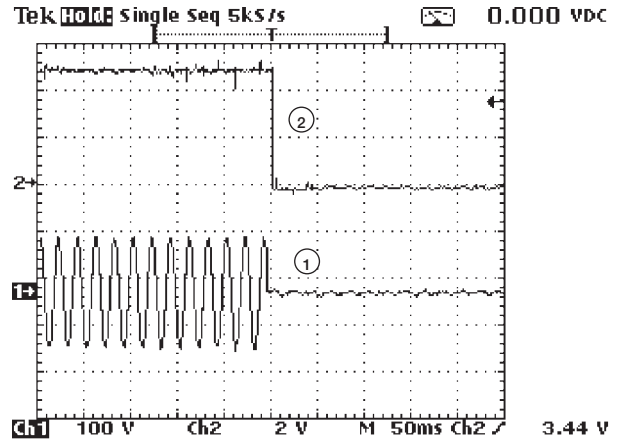

Figure 19
 PF & DC OK signal 'V' AC switch off
 90 VAC full load

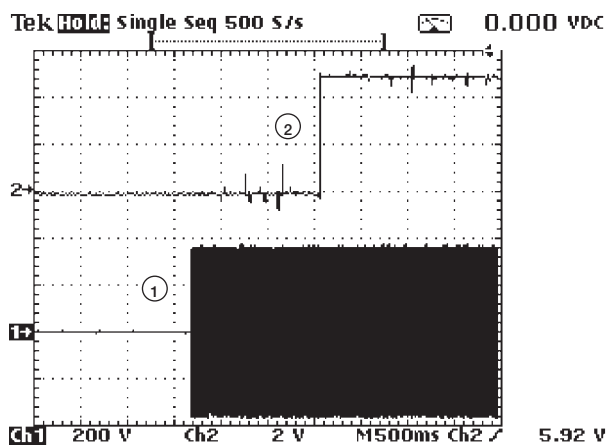

Figure 20
 PF & DC OK signal 'V' AC switch on
 264 VAC full load - 1.4 seconds

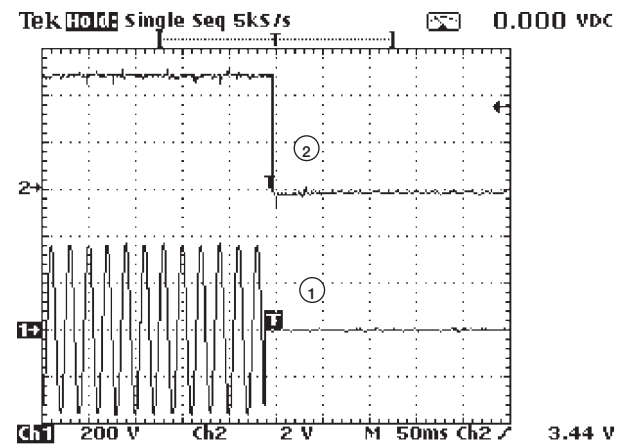

Figure 21
 PF & DC OK signal 'V' AC switch off
 264 VAC full load

Signals

KEY			
① AC	② V1	③ V FAN V2	④ V STANDBY V3

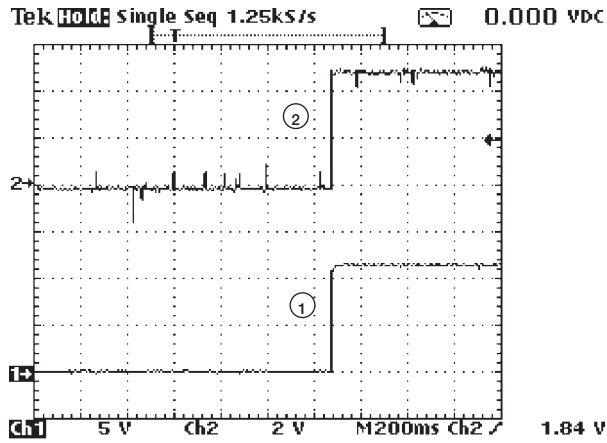

Figure 22
PF/DC OK signal 'V' V1 switch on full load

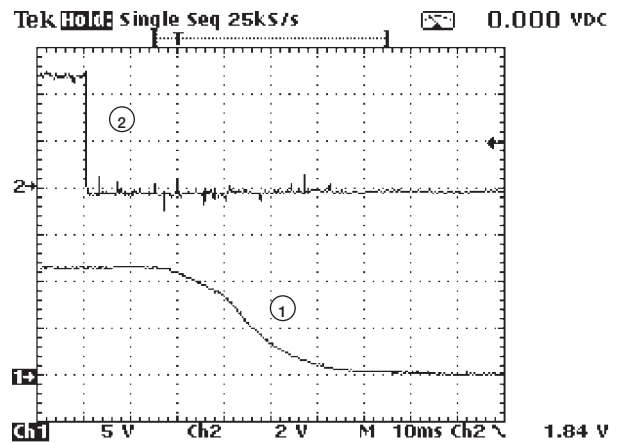

Figure 23
PF/DC OK signal 'V' V1 switch off full load

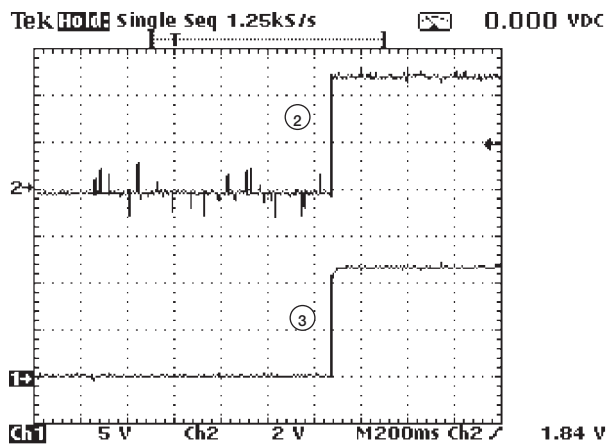

Figure 24
PF/DC OK signal 'V' V2 switch on full load

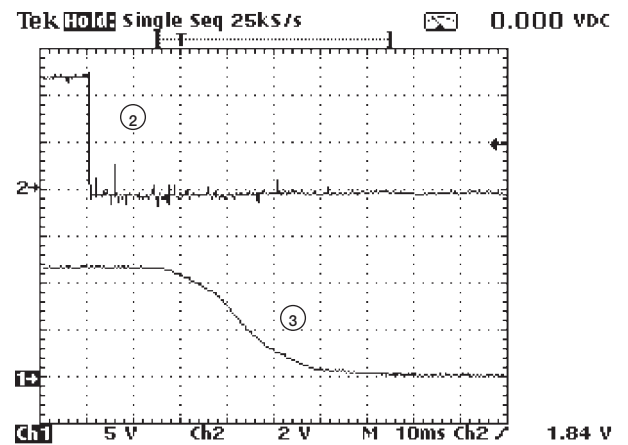

Figure 25
PF/DC OK signal 'V' V2 switch off full load

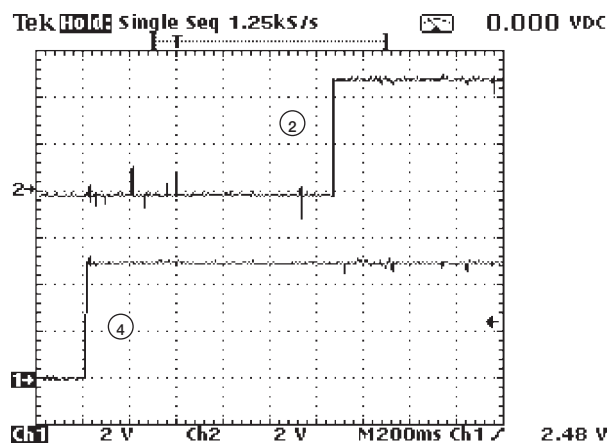

Figure 26
PF/DC OK signal 'V' V3 switch on full load

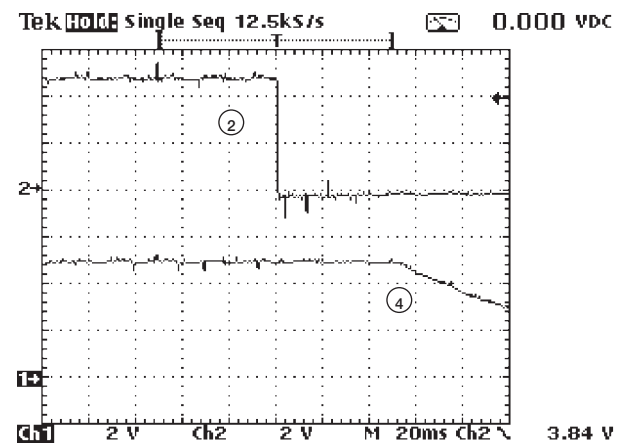

Figure 27
PF/DC OK signal 'V' V3 switch off full load

Environmental

Characteristic	Minimum	Typical	Maximum	Units	Notes & Conditions
Operating Temperature	-10		+70	°C	Derate linearly from +50 °C at 2.5%/°C to 50% at 70 °C
Storage Temperature	-20		+85	°C	
Cooling	12			CFM	See Thermal Considerations. No convection cooled rating
Humidity	5		95	%RH	Non-condensing
Operating Altitude			3000	m	
Shock			30	g peak	Half sine 6 axes
Vibration			2	g	5 Hz to 500 Hz, 3 axes

Electromagnetic Compatibility - Immunity

Phenomenon	Standard	Test Level	Criteria	Notes & Conditions
Harmonic Current	EN61000-3-2		Class A	
EFT	EN61000-4-4	3	A	
Surge	EN61000-4-5	3	A	
Conducted	EN61000-4-6	10V rms	A	
Dips and Interruptions	EN61000-4-11	30% 10 ms	A	
		60% 100 ms	B	
		100% 5000 ms	B	

Electromagnetic Compatibility - Emissions

Phenomenon	Standard	Test Level	Criteria	Notes & Conditions
Conducted	EN55022	Class B		See fig. 19
Radiated	EN55022	Class A		
Voltage Flicker	EN61000-3-3			

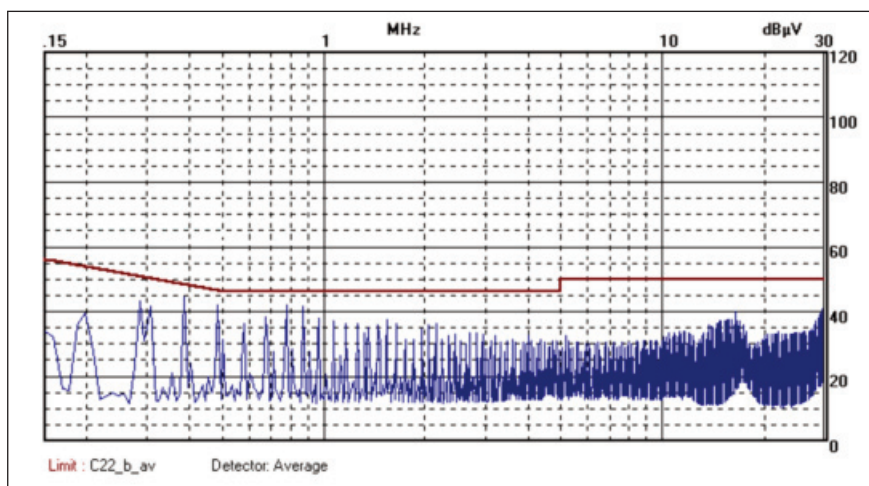
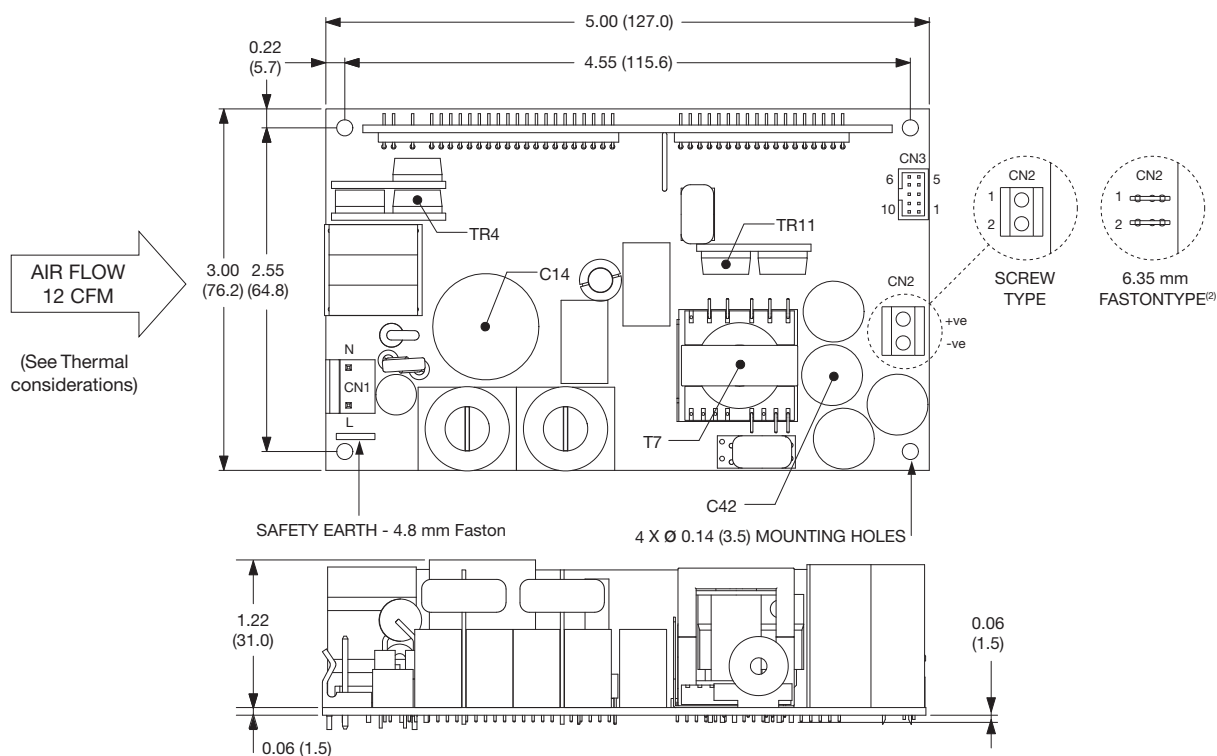

Figure 19
Typical EMC plot

Safety Agency Approvals

Safety Agency	Safety Standard	Category
CB Report	CSA 155548-1790828 IEC60950-1:2001	Information Technology
CSA	CSA CERTIFICATE # 17980822 CSA 22.2 No. 60950-1-03	Information Technology
UL	UL File # E139109 UL60950-1 (2003)	Information Technology
TUV	TUV Certificate # B 07 03 57396 026 EN60950-1/A11:2004	Information Technology
CE	LVD	

Mechanical Details



Notes

1. All dimensions in inches (mm).
2. Units supplied with screw terminal (CN2) as standard. For faston type, add suffix '-F' to the part number.
3. All 4 mounting positions should be connected to safety earth.
4. The air flow needs to be directed through the power supply within the end application.

Pin Connections

PIN CONNECTIONS - CN2	
1	+V1
2	V1 Return

PIN CONNECTIONS - CN3	
1	+V2
2	V2 Return
3	V2 Return
4	ROF
5	ROF Return
6	Power Fail/DC OK
7	Current Share
8	+V3
9	-V3
10	+V2

Mating Connectors:
 CN1: Molex housing 09-50-3031 and crimp 2878.
 CN3: Molex housing 51110-1050 and crimp 50394-8100.

Thermal Considerations

In order to ensure safe operation of the PSU in the end-use equipment, the temperature of the components listed in the table below must not be exceeded. Temperature should be monitored using K type thermocouples placed on the hottest part of the component (out of any direct air flow). See

Temperature Measurements (Ambient \leq 50 °C)	
Component	Max Temperature °C
TR4 case	110 °C
C14	105 °C
C42	105 °C
TR11 case	110 °C
T7 coil	120 °C

drawing on page 11 for component locations.

Service Life

The estimated service life of the EMA212 is determined by the cooling arrangements and load conditions experienced in the end application. Due to the uncertain nature of the end application this estimated service life is based on the actual measured temperature of two key capacitors within the product when installed in the end application. The highest of the two component temperatures should be used.

The graph below expresses the estimated lifetime for a given component temperature and assumes continuous operation at this temperature.

Estimated Service Life vs Component Temperature

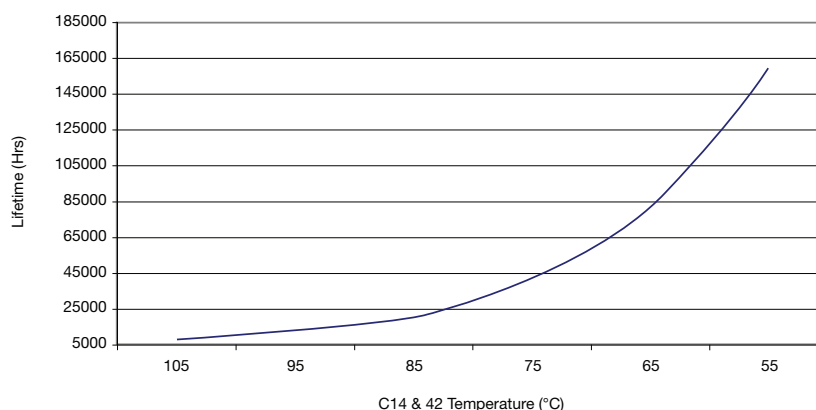



Компания «ЭлектроПласт» предлагает заключение долгосрочных отношений при поставках импортных электронных компонентов на взаимовыгодных условиях!

Наши преимущества:

- Оперативные поставки широкого спектра электронных компонентов отечественного и импортного производства напрямую от производителей и с крупнейших мировых складов;
- Поставка более 17-ти миллионов наименований электронных компонентов;
- Поставка сложных, дефицитных, либо снятых с производства позиций;
- Оперативные сроки поставки под заказ (от 5 рабочих дней);
- Экспресс доставка в любую точку России;
- Техническая поддержка проекта, помощь в подборе аналогов, поставка прототипов;
- Система менеджмента качества сертифицирована по Международному стандарту ISO 9001;
- Лицензия ФСБ на осуществление работ с использованием сведений, составляющих государственную тайну;
- Поставка специализированных компонентов (Xilinx, Altera, Analog Devices, Intersil, Interpoint, Microsemi, Aeroflex, Peregrine, Syfer, Eurofarad, Texas Instrument, Miteq, Cobham, E2V, MA-COM, Hittite, Mini-Circuits, General Dynamics и др.);

Помимо этого, одним из направлений компании «ЭлектроПласт» является направление «Источники питания». Мы предлагаем Вам помощь Конструкторского отдела:

- Подбор оптимального решения, техническое обоснование при выборе компонента;
- Подбор аналогов;
- Консультации по применению компонента;
- Поставка образцов и прототипов;
- Техническая поддержка проекта;
- Защита от снятия компонента с производства.



Как с нами связаться

Телефон: 8 (812) 309 58 32 (многоканальный)

Факс: 8 (812) 320-02-42

Электронная почта: org@eplast1.ru

Адрес: 198099, г. Санкт-Петербург, ул. Калинина, дом 2, корпус 4, литера А.