

General Description

The MIC863 is a dual low-power operational amplifier in a SOT23-8 package. It is designed to operate in the 2V to 5V range, rail-to-rail output, with input common-mode to ground. The MIC863 provides 450kHz gain-bandwidth product while consuming only a 4.2 μ A supply current

With low supply voltage and 8-pin SOT-23 packaging, MIC863 provides two channels as general-purpose amplifiers for portable and battery-powered applications. Its package provides the maximum performance available while maintaining an extremely slim form factor. The minimal power consumption of this IC maximizes the battery life potential.

Datasheets and support documentation are available on Micrel's web site at: www.micrel.com.

Features

- 8-Pin SOT-23 package
- 450kHz gain-bandwidth product
- 800kHz, -3dB bandwidth
- 4.2 μ A supply current/channel
- Rail-to-rail output
- Ground sensing at input (common mode-to-GND)
- Drives large capacitive loads (0.02 μ F)
- Unity gain stable

Applications

- Portable equipment
- Medical instrument
- PDAs
- Pagers
- Cordless phones
- Consumer electronics

Typical Application

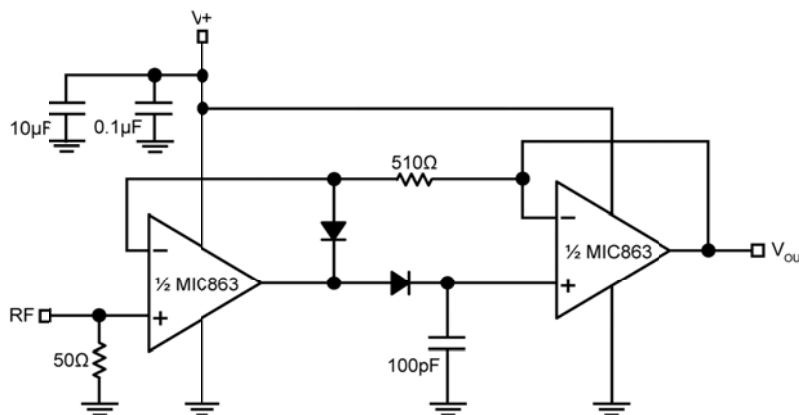

Peak Detector Circuit for AM Radio

Ordering Information

Part Number	Marking ⁽¹⁾	Junction Temperature Range	Lead Finish	Package
MIC863YM8	<u>A</u> 35	-40°C to +85°C	Pb-Free	8-Pin SOT-23

Note:

- Underbar () may not be to scale.

Pin Configuration

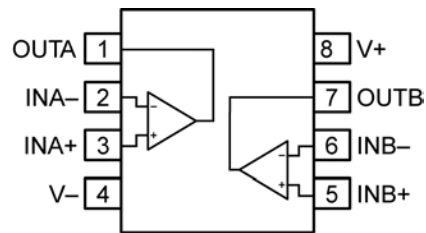

8-Pin SOT-23 (M8)
(Top View)

Pin Description

Pin Number	Pin Name	Pin Function
1	OUTA	Amplifier A Output.
2	INA-	Amplifier A Inverting Input.
3	INA+	Amplifier A Non-Inverting Input
4	V-	Negative Supply.
5	INB+	Amplifier B Non-Inverting Input.
6	INB-	Amplifier B Inverting Input.
7	OUTB	Amplifier B Output.
8	V+	Positive Supply

Absolute Maximum Ratings⁽²⁾

Supply Voltage ($V_{V+} - V_{V-}$)	+6.0V
Differential Input Voltage ($ V_{IN+} - V_{IN-} $) ⁽⁴⁾	+6.0V
Input Voltage ($V_{IN+} - V_{IN-}$)	$V_{V+} + 0.3V, V_{V-} - 0.3V$
Lead Temperature (soldering, 10s)	260°C
Output Short-Circuit Current Duration	Indefinite
Storage Temperature (T_s)	150°C
ESD Rating ⁽⁵⁾	ESD Sensitive

Operating Ratings⁽³⁾

Supply Voltage ($V_{V+} - V_{V-}$)	+2.0V to +5.25V
Ambient Temperature (T_A)	-40°C to +85°C
Package Thermal Resistance	
θ_{JA} (Using 4-Layer PCB)	100°C/W
θ_{CA} (Using 4-Layer PCB)	70°C/W

Electrical Characteristics

$V_+ = +2V, V_- = 0V, V_{CM} = V_+/2; R_L = 500k\Omega$ to $V_+/2; T_A = 25^\circ C$, unless otherwise noted. **Bold** values indicate $-40^\circ C \leq T_A \leq +85^\circ C$.

Symbol	Parameter	Condition	Min.	Typ.	Max.	Units
V_{OS}	Input Offset Voltage		-6	0.1	+6	mV
			-5		+5	
	Differential Offset Voltage			0.5		mV
	Input Offset Voltage Temperature Coefficient			6		$\mu V/^\circ C$
I_B	Input Bias Current			10		pA
I_{OS}	Input Offset Current			5		pA
V_{CM}	Input Voltage Range	CMRR > 50dB	0.5	1		V
CMRR	Common-Mode Rejection Ratio	$0 < V_{CM} < 1V$	45	75		dB
PSRR	Power Supply Rejection Ratio	Supply voltage change of 2V to 2.7V	50	85		dB
A_{VOL}	Large-Signal Voltage Gain	$R_L = 100k\Omega, V_{OUT} = 1.4V_{PP}$	66	81		dB
		$R_L = 500k\Omega, V_{OUT} = 1.4V_{PP}$	73	90		
V_{OUT}	Maximum Output Voltage Swing	$R_L = 500k\Omega$	V+ - 3mV	$V_+ - 1.4mV$		V
	Minimum Output Voltage Swing	$R_L = 500k\Omega$		$V_- + 0.5mV$	V- + 3mV	
GBW	Gain-Bandwidth Product	$R_L = 200k\Omega, C_L = 2pF, A_V = 11$		320		kHz
PM	Phase Margin	$R_L = 200k\Omega, C_L = 2pF, A_V = 11$		69		°
BW	-3dB Bandwidth	$A_V = 1, C_L = 2pF, R_L = 1M\Omega$		600		kHz
SR	Slew Rate	$A_V = 1, C_L = 2pF, R_L = 1M\Omega$, Positive Slew Rate = $0.17V/\mu s$		0.33		V/ μs
I_{SC}	Short-Circuit Output Current	Source	1.8	2.6		mA
		Sink	1.5	2.2		
I_S	Supply Current (per Op Amp)	No Load		3.5	7	μA
	Channel-to-Channel Crosstalk	Note 6		-100		dB

Notes:

- Exceeding the absolute maximum ratings may damage the device.
- The device is not guaranteed to function outside its operating ratings.
- Exceeding the maximum differential input voltage will damage the input stage and degrade performance (in particular, input bias current is likely to increase).
- Devices are ESD sensitive. Handling precautions are recommended. Human body model, 1.5k Ω in series with 100pF.
- DC signal referenced to input. Refer to the *Typical Characteristics* section for "AC Performance Characteristics".

Electrical Characteristics

$V_+ = +2.7V$, $V_- = 0V$, $V_{CM} = V_+/2$; $R_L = 500k\Omega$ to $V_+/2$; $T_A = 25^\circ C$, unless otherwise noted. **Bold** values indicate $-40^\circ C \leq T_A \leq +85^\circ C$.

Symbol	Parameter	Condition	Min.	Typ.	Max.	Units
V_{OS}	Input Offset Voltage		-6	0.1	+6	mV
			-5		+5	
	Differential Offset Voltage			0.5		mV
	Input Offset Voltage Temperature Coefficient			6		$\mu V/^\circ C$
I_B	Input Bias Current			10		pA
I_{OS}	Input Offset Current			5		pA
V_{CM}	Input Voltage Range	CMRR > 60dB	1	1.8		V
CMRR	Common-Mode Rejection Ratio	$0 < V_{CM} < 1.35V$	60	83		dB
PSRR	Power Supply Rejection Ratio	Supply voltage change of 2.7V to 3V	55	85		dB
A_{VOL}	Large-Signal Voltage Gain	$R_L = 100k\Omega$, $V_{OUT} = 2V_{PP}$	70	83		dB
		$R_L = 500k\Omega$, $V_{OUT} = 2V_{PP}$	78	91		
GBW	Gain-Bandwidth Product	$R_L = 200k\Omega$, $C_L = 2pF$, $A_V = 11$		350		kHz
PM	Phase Margin	$R_L = 200k\Omega$, $C_L = 2pF$, $A_V = 11$		65		$^\circ$
BW	-3dB Bandwidth	$A_V = 1$, $C_L = 2pF$, $R_L = 1M\Omega$		600		kHz
SR	Slew Rate	$A_V = 1$, $C_L = 2pF$, $R_L = 1M\Omega$, Positive Slew Rate = $0.17V/\mu s$		0.35		$V/\mu s$
I_{SC}	Short-Circuit Output Current	Source	4.5	6.3		mA
		Sink	4.5	6.2		
I_S	Supply Current (per Op Amp)	No Load		3.6	7	μA
	Channel-to-Channel Crosstalk	Note 6		-120		dB

Electrical Characteristics

$V_+ = +5V$, $V_- = 0V$, $V_{CM} = V_+/2$; $R_L = 500k\Omega$ to $V_+/2$; $T_A = 25^\circ C$, unless otherwise noted. **Bold** values indicate $-40^\circ C \leq T_A \leq +85^\circ C$.

Symbol	Parameter	Condition	Min.	Typ.	Max.	Units
V_{OS}	Input Offset Voltage		-6	0.1	+6	mV
			-5		+5	
	Differential Offset Voltage			0.5		mV
	Input Offset Voltage Temperature Coefficient			6		$\mu V/^\circ C$
I_B	Input Bias Current			10		pA
I_{OS}	Input Offset Current			5		pA
V_{CM}	Input Voltage Range	CMRR > 60dB	3.5	4.1		V
CMRR	Common-Mode Rejection Ratio	$0 < V_{CM} < 3.5V$	60	85		dB
PSRR	Power Supply Rejection Ratio	Supply voltage change of 3V to 5V	60	86		dB
A_{VOL}	Large-Signal Voltage Gain	$R_L = 100k\Omega$, $V_{OUT} = 4.0V_{PP}$	73	81		dB
		$R_L = 500k\Omega$, $V_{OUT} = 4.0V_{PP}$	78	88		
V_{OUT}	Maximum Output Voltage Swing	$R_L = 500k\Omega$	V+ - 3mV	$V_+ - 1.3mV$		V
	Minimum Output Voltage Swing	$R_L = 500k\Omega$		$V_- + 0.7mV$	V- + 3mV	
GBW	Gain-Bandwidth Product	$R_L = 200k\Omega$, $C_L = 2pF$, $A_V = 11$		450		kHz
PM	Phase Margin			63		$^\circ$
BW	-3dB Bandwidth	$A_V = 1$, $C_L = 2pF$, $R_L = 1M\Omega$		800		kHz
SR	Slew Rate	$A_V = 1$, $C_L = 2pF$, $R_L = 1M\Omega$, Positive Slew Rate = $0.2V/\mu s$		0.35		V/ μs
I_{SC}	Short-Circuit Output Current	Source	17	23		mA
		Sink	18	27		
I_S	Supply Current (per Op Amp)	No Load		4.2	8	μA
	Channel-to-Channel Crosstalk	Note 6		-120		dB

Typical Characteristics

DC Performance Characteristics

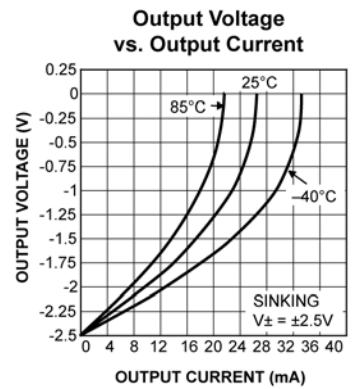
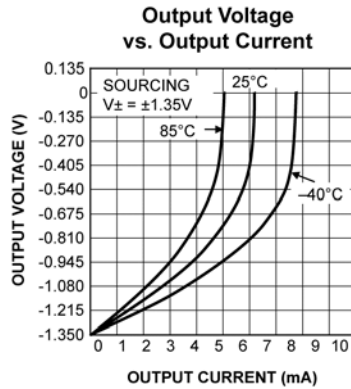
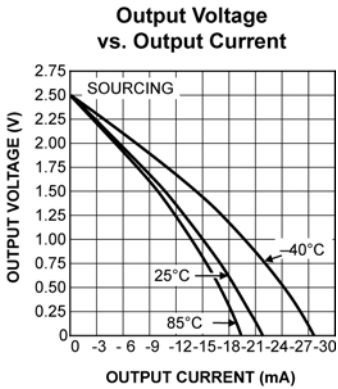
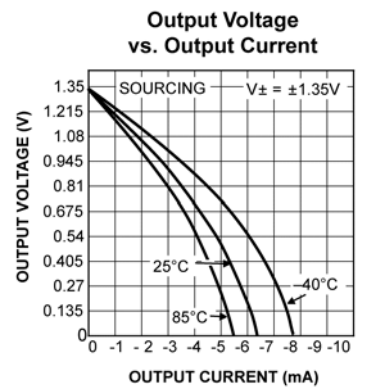
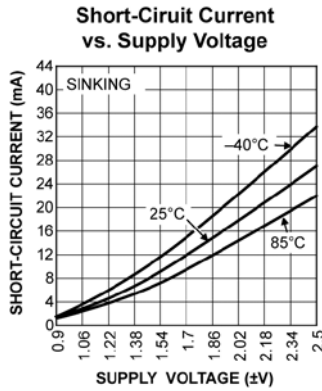
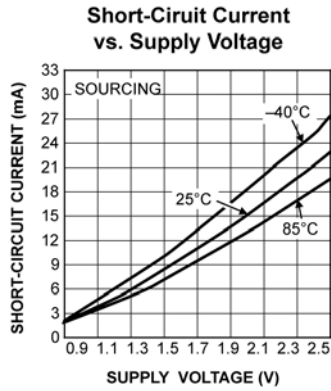
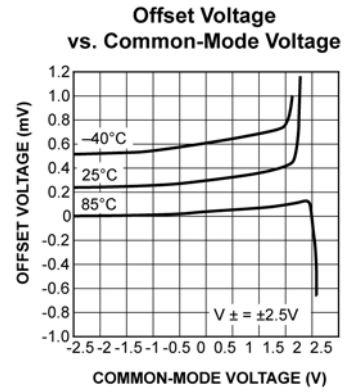
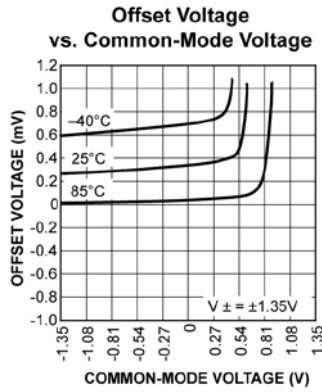
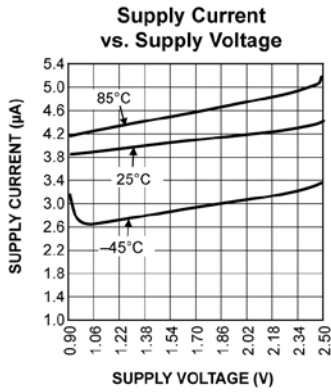

Typical Characteristics (Continued)

DC Performance Characteristics (Continued)

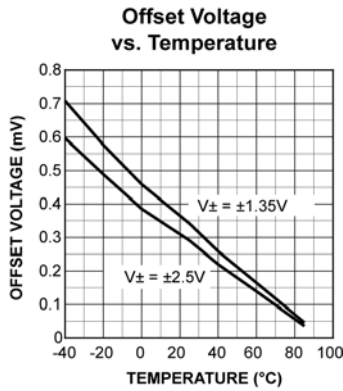
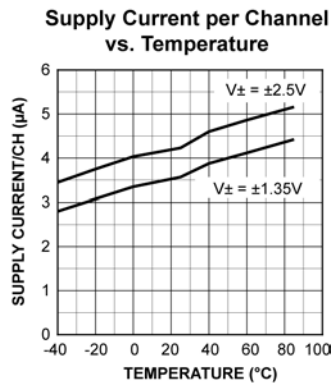
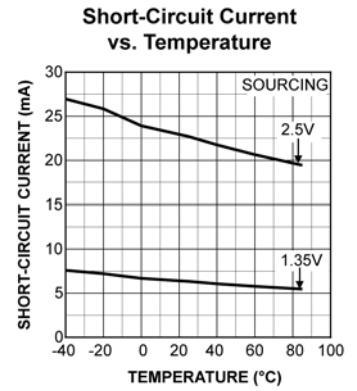
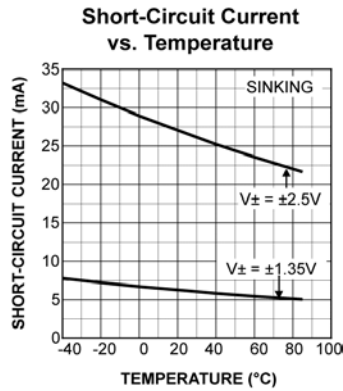
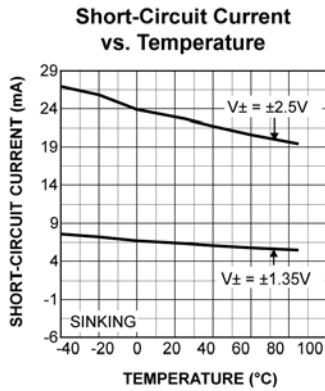

Typical Characteristics (Continued)

AC Performance Characteristics

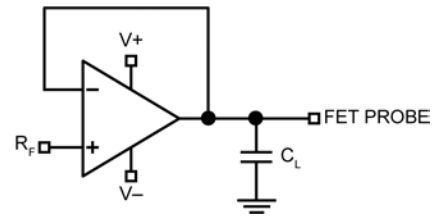
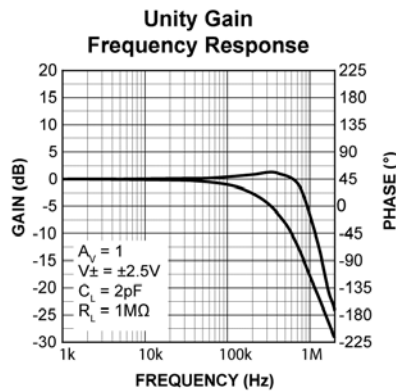
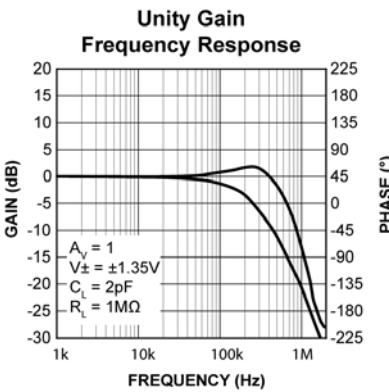
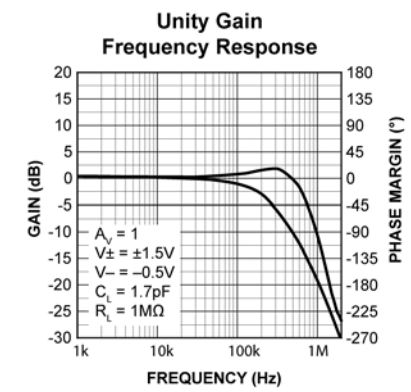
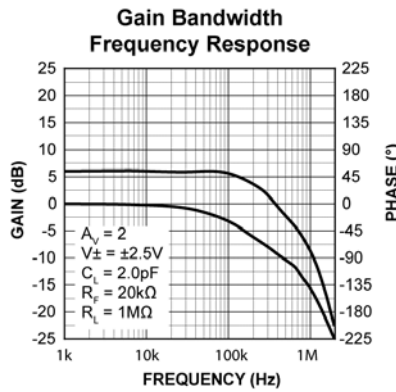
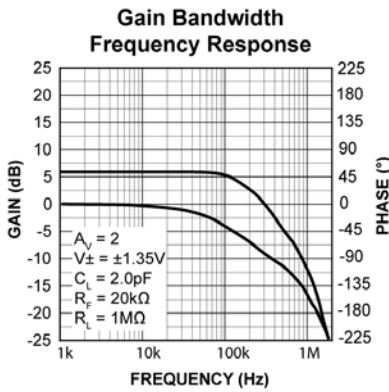
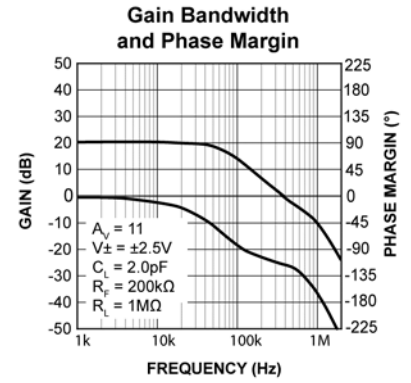
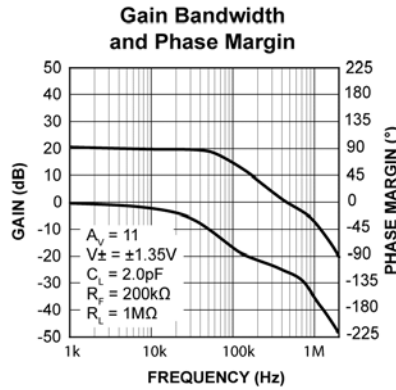
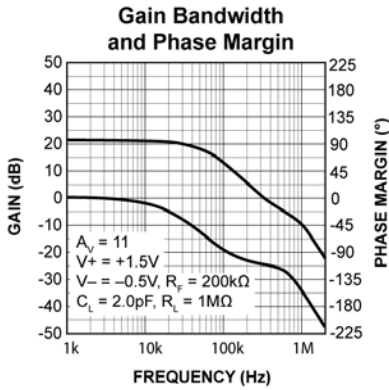

Typical Characteristics (Continued)

AC Performance Characteristics (Continued)

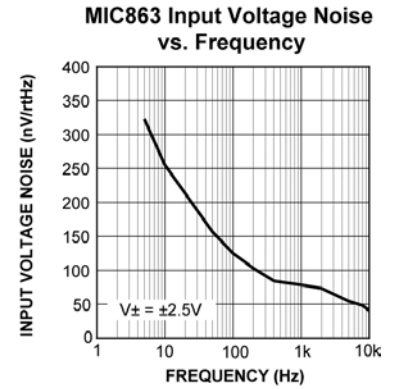
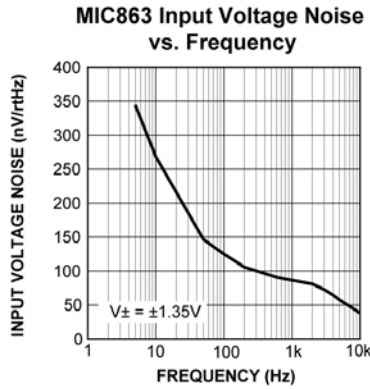
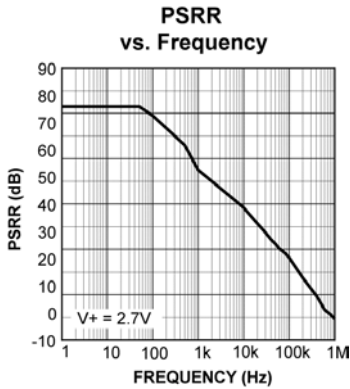
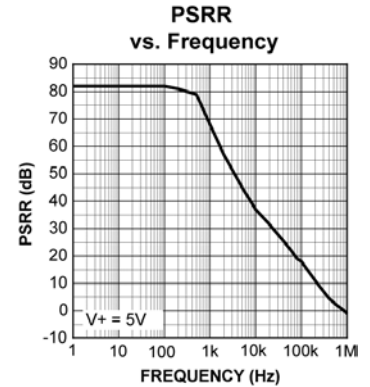
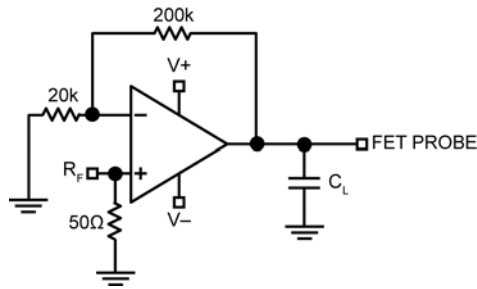
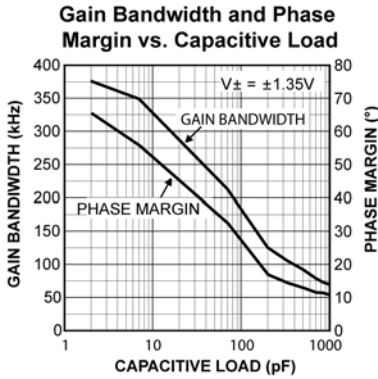
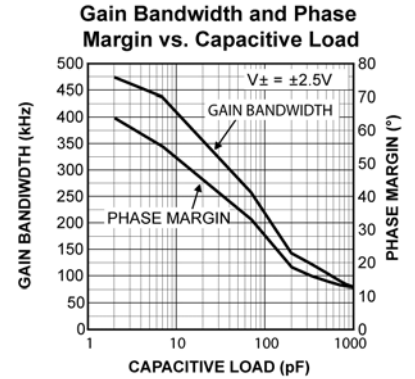
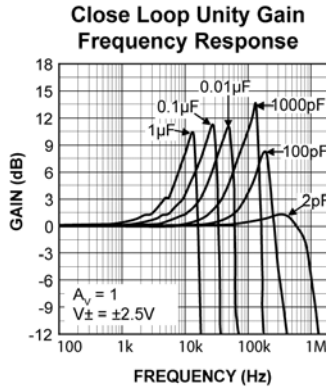
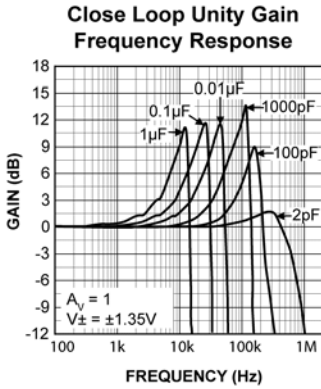

Typical Characteristics (Continued)

AC Performance Characteristics (Continued)

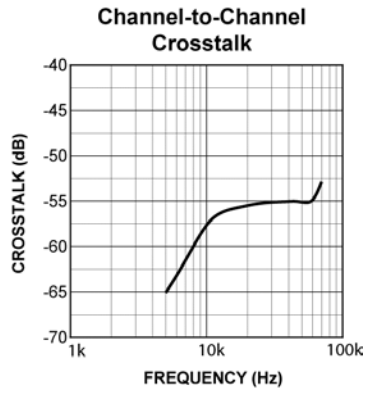

Functional Characteristics

Small Signal Pulse Response

Test Circuit 3: $A_V = 1$

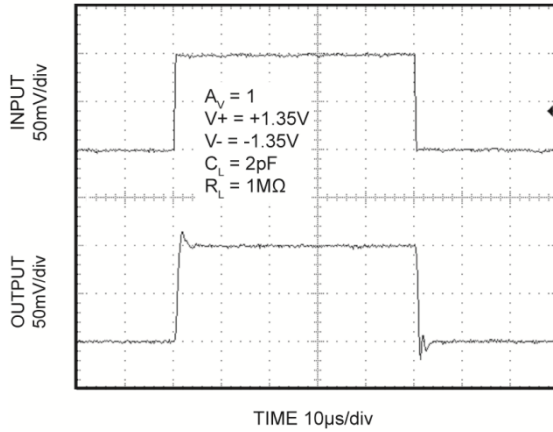

Small Signal Pulse Response

Test Circuit 3: $A_V = 1$

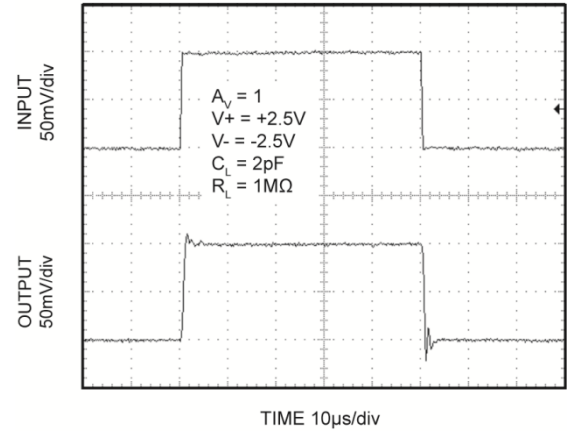

Small Signal Pulse Response

Test Circuit 3: $A_V = 1$

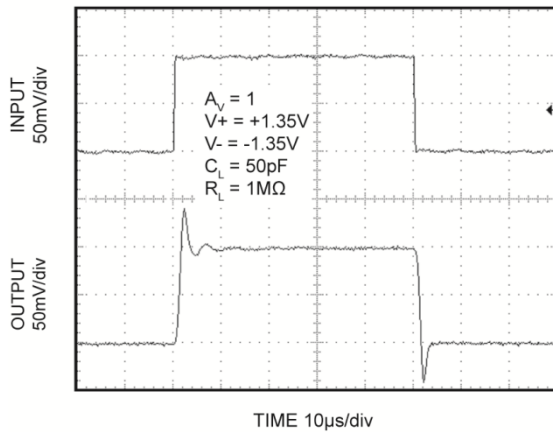

Small Signal Pulse Response

Test Circuit 3: $A_V = 1$

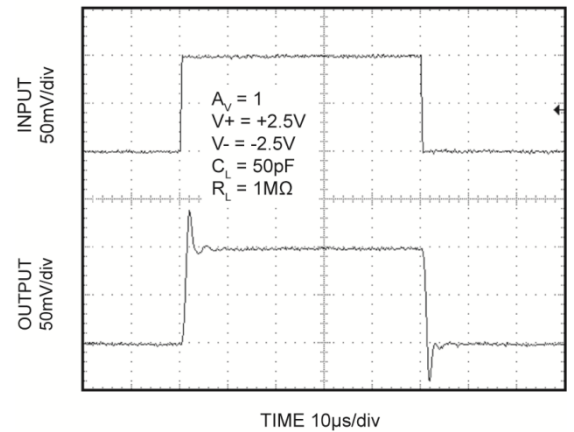

Small Signal Pulse Response

Test Circuit 3: $A_V = 1$

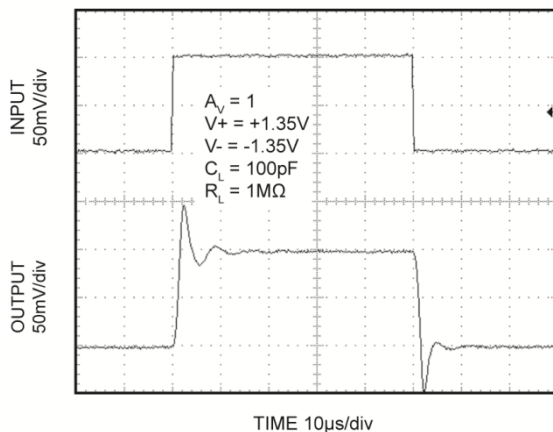

Small Signal Pulse Response

Test Circuit 3: $A_V = 1$

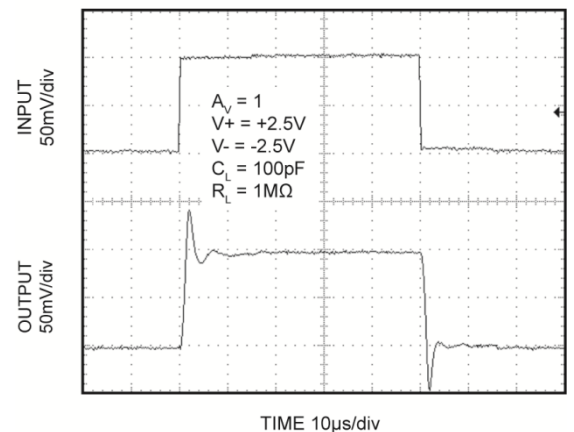

Functional Characteristics (Continued)

Small Signal Pulse Response

Test Circuit 3: $A_V = 1$

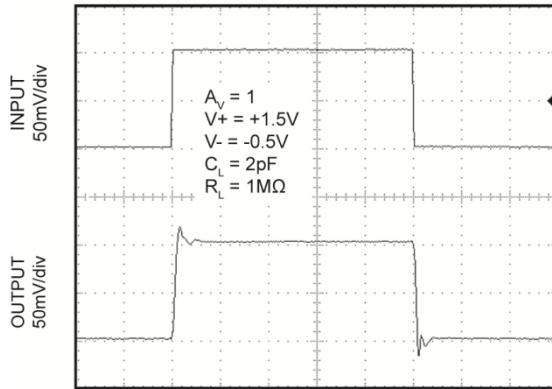

Small Signal Pulse Response

Test Circuit 4: $A_V = -1$

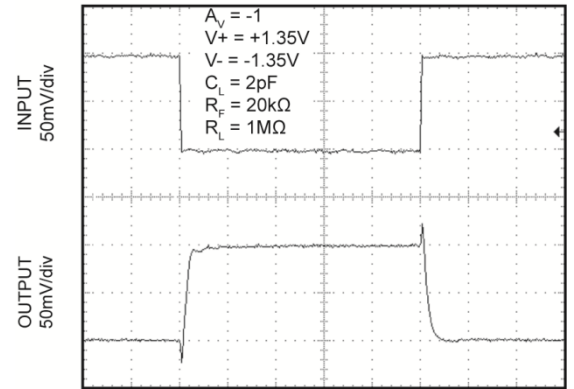

Small Signal Pulse Response

Test Circuit 4: $A_V = -1$

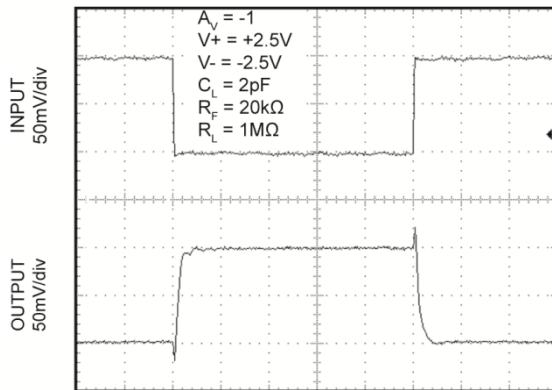

Small Signal Pulse Response

Test Circuit 4: $A_V = -1$

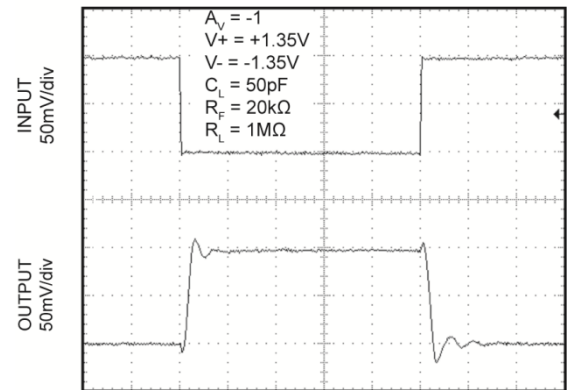

Small Signal Pulse Response

Test Circuit 4: $A_V = -1$

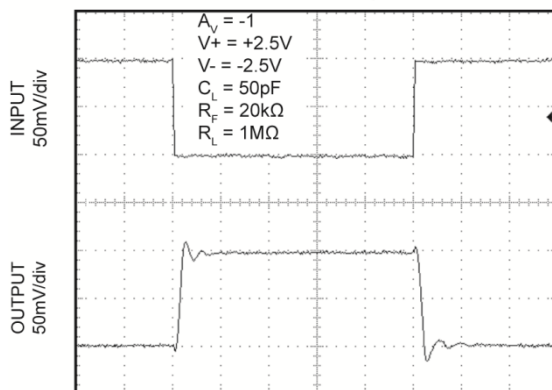

Large Signal Pulse Response

Test Circuit 3: $A_V = 1$

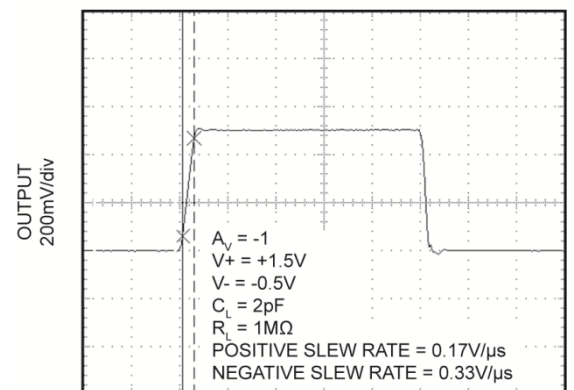

Functional Characteristics (Continued)

Large Signal Pulse Response

Test Circuit 3: $A_V = 1$

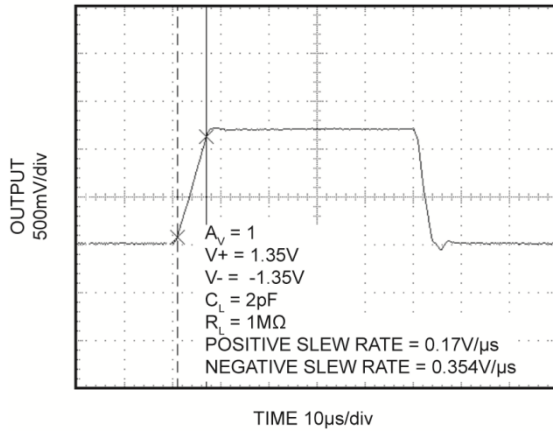

Large Signal Pulse Response

Test Circuit 3: $A_V = 1$

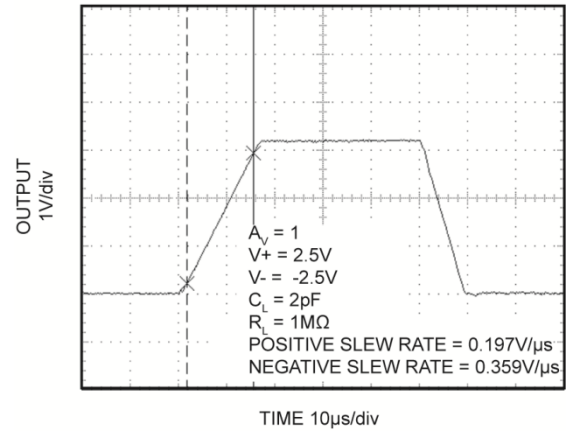

Large Signal Pulse Response

Test Circuit 3: $A_V = 1$

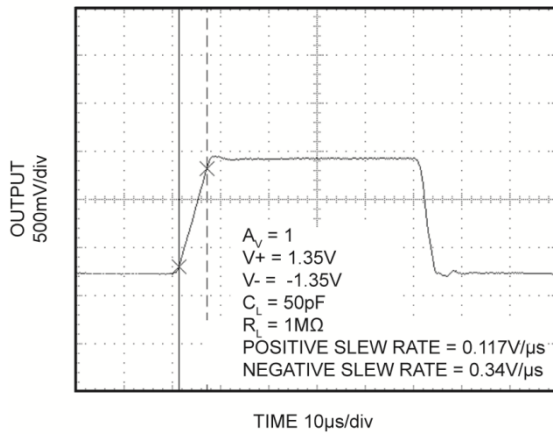

Large Signal Pulse Response

Test Circuit 3: $A_V = 1$

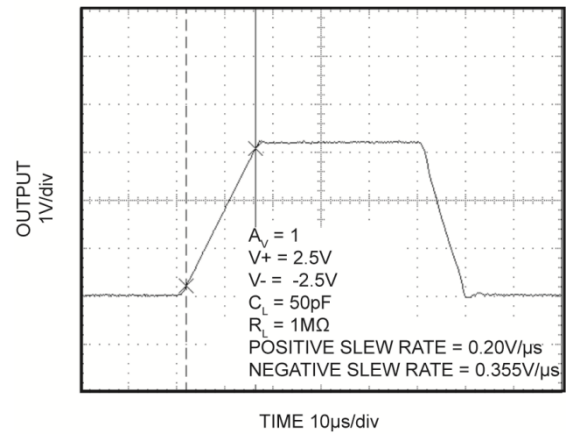

Large Signal Pulse Response

Test Circuit 3: $A_V = 1$

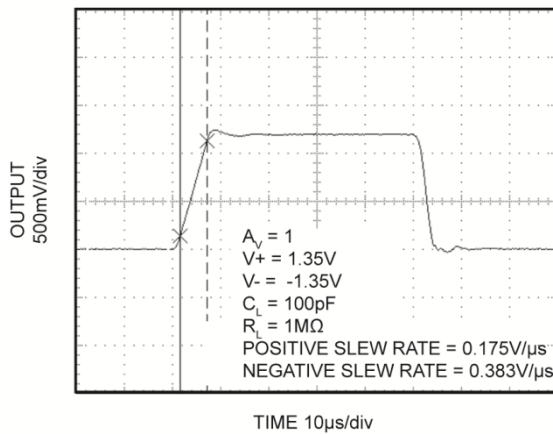

Large Signal Pulse Response

Test Circuit 3: $A_V = 1$

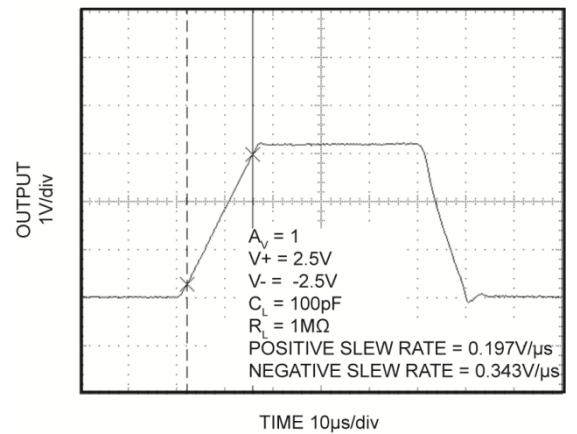

Functional Characteristics (Continued)

Rail-to-Rail Output Operation

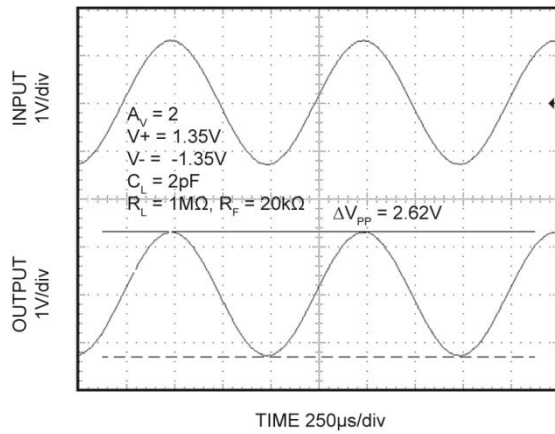

Rail-to-Rail Output Operation

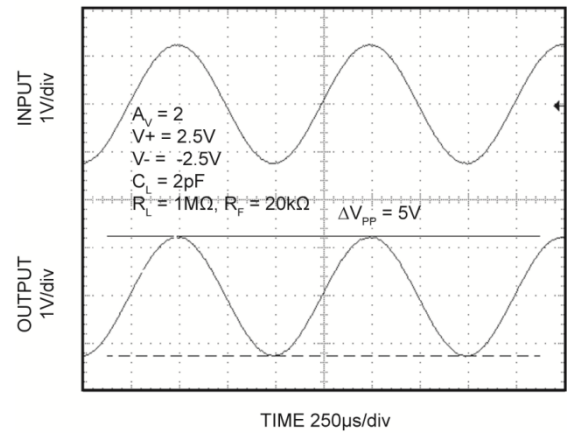

Rail-to-Rail Output Operation

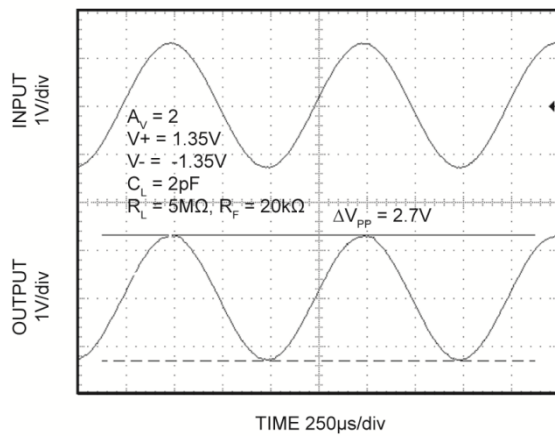

Rail-to-Rail Output Operation

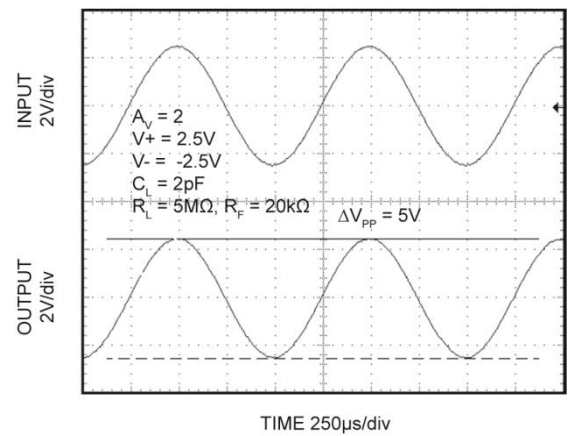

Application Information

Regular supply bypassing techniques are recommended. A 10 μ F capacitor in parallel with a 0.1 μ F capacitor on both the positive and negative supplies are ideal. For best performance all bypassing capacitors should be located as close to the op amp as possible and all capacitors should be low equivalent series inductance (ESL), equivalent series resistance (ESR). Surface-mount ceramic capacitors are ideal.

The MIC863 is intended for single-supply applications configured with a grounded load. It is not advisable to operate the MIC863 under either of the following conditions when the load is less than 20k Ω and the output swing is greater than 1V (peak-to-peak):

1. A grounded load and split supplies ($\pm V$)
or
2. A single supply where the load is terminated above ground.

Under the above listed conditions, there may be some instability when the output is sinking current.

Package Information⁽⁷⁾

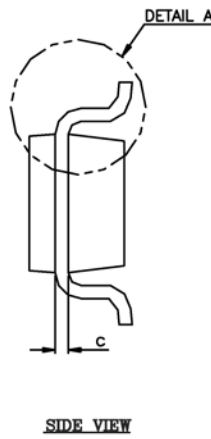
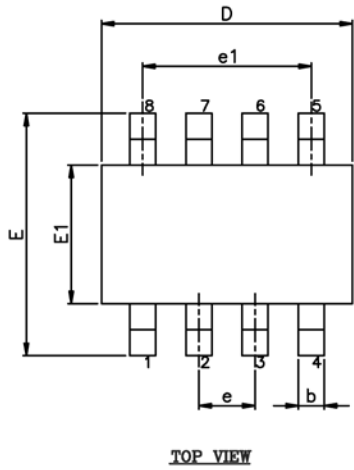

VARIATION(ALL DIMENSIONS SHOWN IN MM)

SYMBOL	MIN.	NOM.	MAX.
A	-	-	1.45
A1	0.00	-	0.15
A2	0.90	1.15	1.30
b	0.22	-	0.38
c	0.08	-	0.22
D	2.90 BSC.		
E	2.80 BSC.		
E1	1.60 BSC.		
e	0.65 BSC.		
e1	1.95 BSC.		
L	0.30	0.45	0.60
L1	0.60 REF.		
L2	0.25 BSC.		
R	0.10	-	-
R1	0.10	-	0.25
θ	0°	4°	8°
θ1	5°	10°	15°

NOTE :
1. JEDEC OUTLINE : MO-178 BA.

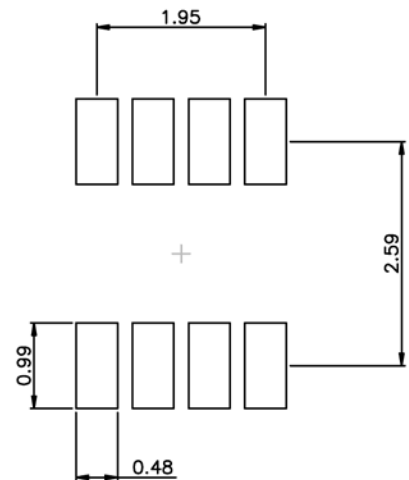
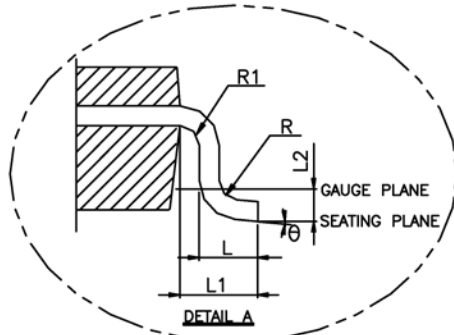
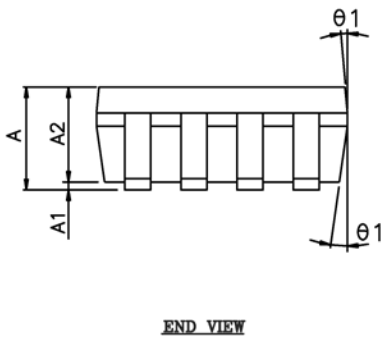

8-Pin SOT-23 (M8)

Note:

7. Package information is correct as of the publication date. For updates and most current information, go to www.micrel.com.

MICREL, INC. 2180 FORTUNE DRIVE SAN JOSE, CA 95131 USA
TEL +1 (408) 944-0800 FAX +1 (408) 474-1000 WEB <http://www.micrel.com>

Micrel makes no representations or warranties with respect to the accuracy or completeness of the information furnished in this data sheet. This information is not intended as a warranty and Micrel does not assume responsibility for its use. Micrel reserves the right to change circuitry, specifications and descriptions at any time without notice. No license, whether express, implied, arising by estoppel or otherwise, to any intellectual property rights is granted by this document. Except as provided in Micrel's terms and conditions of sale for such products, Micrel assumes no liability whatsoever, and Micrel disclaims any express or implied warranty relating to the sale and/or use of Micrel products including liability or warranties relating to fitness for a particular purpose, merchantability, or infringement of any patent, copyright or other intellectual property right.

Micrel Products are not designed or authorized for use as components in life support appliances, devices or systems where malfunction of a product can reasonably be expected to result in personal injury. Life support devices or systems are devices or systems that (a) are intended for surgical implant into the body or (b) support or sustain life, and whose failure to perform can be reasonably expected to result in a significant injury to the user. A Purchaser's use or sale of Micrel Products for use in life support appliances, devices or systems is a Purchaser's own risk and Purchaser agrees to fully indemnify Micrel for any damages resulting from such use or sale.

© 2005 Micrel, Incorporated.

Mouser Electronics

Authorized Distributor

Click to View Pricing, Inventory, Delivery & Lifecycle Information:

[Microchip:](#)

[MIC863YM8-TR](#)



Компания «ЭлектроПласт» предлагает заключение долгосрочных отношений при поставках импортных электронных компонентов на взаимовыгодных условиях!

Наши преимущества:

- Оперативные поставки широкого спектра электронных компонентов отечественного и импортного производства напрямую от производителей и с крупнейших мировых складов;
- Поставка более 17-ти миллионов наименований электронных компонентов;
- Поставка сложных, дефицитных, либо снятых с производства позиций;
- Оперативные сроки поставки под заказ (от 5 рабочих дней);
- Экспресс доставка в любую точку России;
- Техническая поддержка проекта, помощь в подборе аналогов, поставка прототипов;
- Система менеджмента качества сертифицирована по Международному стандарту ISO 9001;
- Лицензия ФСБ на осуществление работ с использованием сведений, составляющих государственную тайну;
- Поставка специализированных компонентов (Xilinx, Altera, Analog Devices, Intersil, Interpoint, Microsemi, Aeroflex, Peregrine, Syfer, Eurofarad, Texas Instrument, Miteq, Cobham, E2V, MA-COM, Hittite, Mini-Circuits, General Dynamics и др.);

Помимо этого, одним из направлений компании «ЭлектроПласт» является направление «Источники питания». Мы предлагаем Вам помощь Конструкторского отдела:

- Подбор оптимального решения, техническое обоснование при выборе компонента;
- Подбор аналогов;
- Консультации по применению компонента;
- Поставка образцов и прототипов;
- Техническая поддержка проекта;
- Защита от снятия компонента с производства.



Как с нами связаться

Телефон: 8 (812) 309 58 32 (многоканальный)

Факс: 8 (812) 320-02-42

Электронная почта: org@eplast1.ru

Адрес: 198099, г. Санкт-Петербург, ул. Калинина, дом 2, корпус 4, литера А.