



MS310-10*

DRAWN EMI/RFI SHIELD DATA-SHEET

*OPTIONAL SHIELD CONFIGURATIONS

| MS SHIELD | MS SET PN. | MS ITEM PN. | DESCRIPTION | RAW MATERIAL |
|--|-------------|--------------|------------------------|-----------------|
|  | MS310-10 | MS310-10C | TWO-PIECE SHIELD COVER | TIN STEEL* |
| | | MS310-10F | TWO-PIECE SHIELD FRAME | |
| | MS310-10-NS | MS310-10C-NS | TWO-PIECE SHIELD COVER | NICKEL SILVER** |
| | | MS310-10F-NS | TWO-PIECE SHIELD FRAME | |
|  | | MS310-10S | ONE-PIECE SHIELD | TIN STEEL* |
| | | MS310-10S-NS | ONE-PIECE SHIELD | NICKEL SILVER** |

* TIN-PLATED STEEL: CRS ELECTROLYTIC TINPLATE

** NICKEL SILVER: UNS C77000 / UNS C73500



MS PN:

DESCRIPTION:

MATERIAL:

© MASACH TECH LTD.
22 HAGANAN, MODIIN 7169513 ISRAEL
T: (+972) 8-9754681 / F: (+972) 8-9754682
info@masach.com / www.masach.com



SHIELD TYPE:

SEAMLESS PROTECTIVE EMI/RFI CAGE



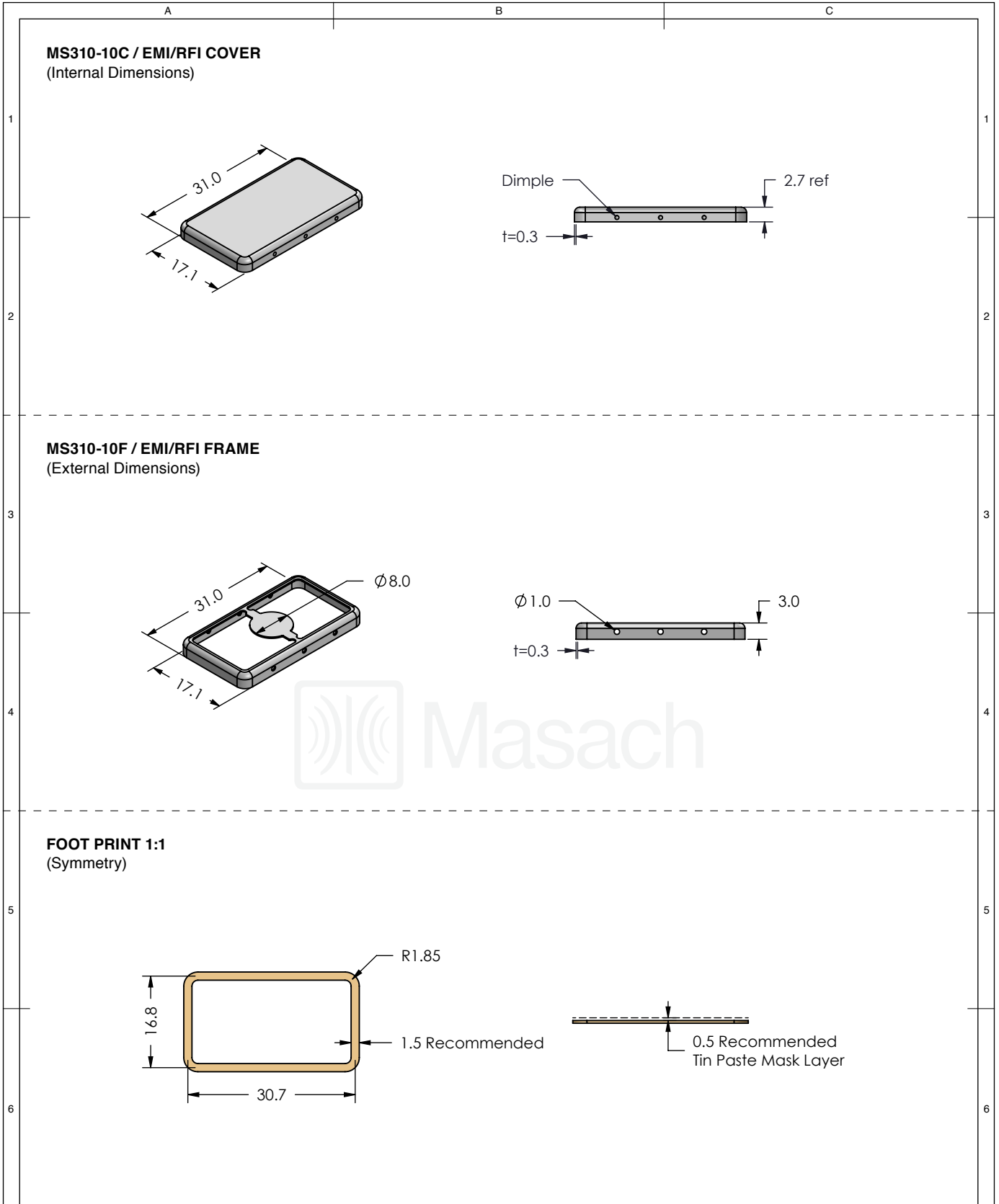

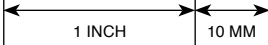

MMGS / PRINT 1:1 / A4

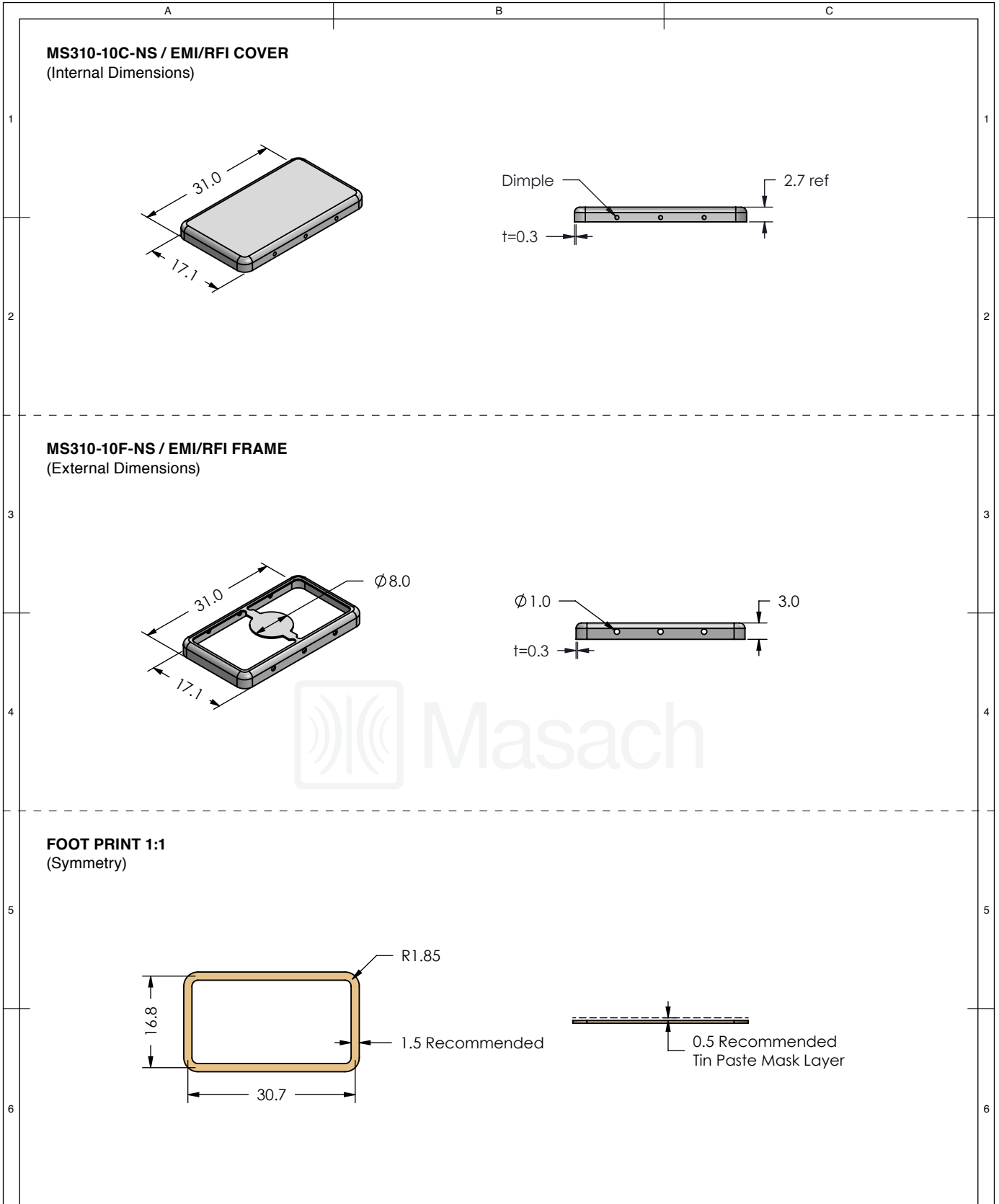

| | | | |
|--|---|---|---|
|  | MS SET PN: | DESCRIPTION: | MATERIAL: |
| | MS310-10 | TWO-PIECE EM/RF SHIELD | TIN PLATED STEEL (1) |
| <p>NOTE: (1) CRS ELECTROLYTIC TINPLATE (2) GENERAL TOLERANCE (+/-) 0.2MM</p> | | | |
| <p>© MASACH TECH LTD. 22 HAGANAN, MODIIN 7169513 ISRAEL T: (+972) 8-9754681 / F: (+972) 8-9754682 info@masach.com / www.masach.com</p> | SHIELD TYPE: |   |  |
| | SEAMLESS PROTECTIVE EMI/RFI CAGE | | MMGS / PRINT 1:1 / A4 |

This product has been designed and manufactured by © Masach Tech Ltd. The use of this product in any type of electronic device or application is not under Masach Tech Ltd. liability.

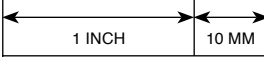

| | | | |
|--|---|---|---|
|  | MS SET PN: | DESCRIPTION: | MATERIAL: |
| | MS310-10-NS | TWO-PIECE EMI/RF SHIELD | NICKEL SILVER (1) |
| <p>NOTE: (1) UNS C77000 / UNS C73500 (2) GENERAL TOLERANCE (+/-) 0.2MM</p> | | | |
| <p>© MASACH TECH LTD. 22 HAGANAN, MODIIN 7169513 ISRAEL T: (+972) 8-9754681 / F: (+972) 8-9754682 info@masach.com / www.masach.com</p> | SHIELD TYPE: |   |  |
| | SEAMLESS PROTECTIVE EMI/RFI CAGE | | MMGS / PRINT 1:1 / A4 |

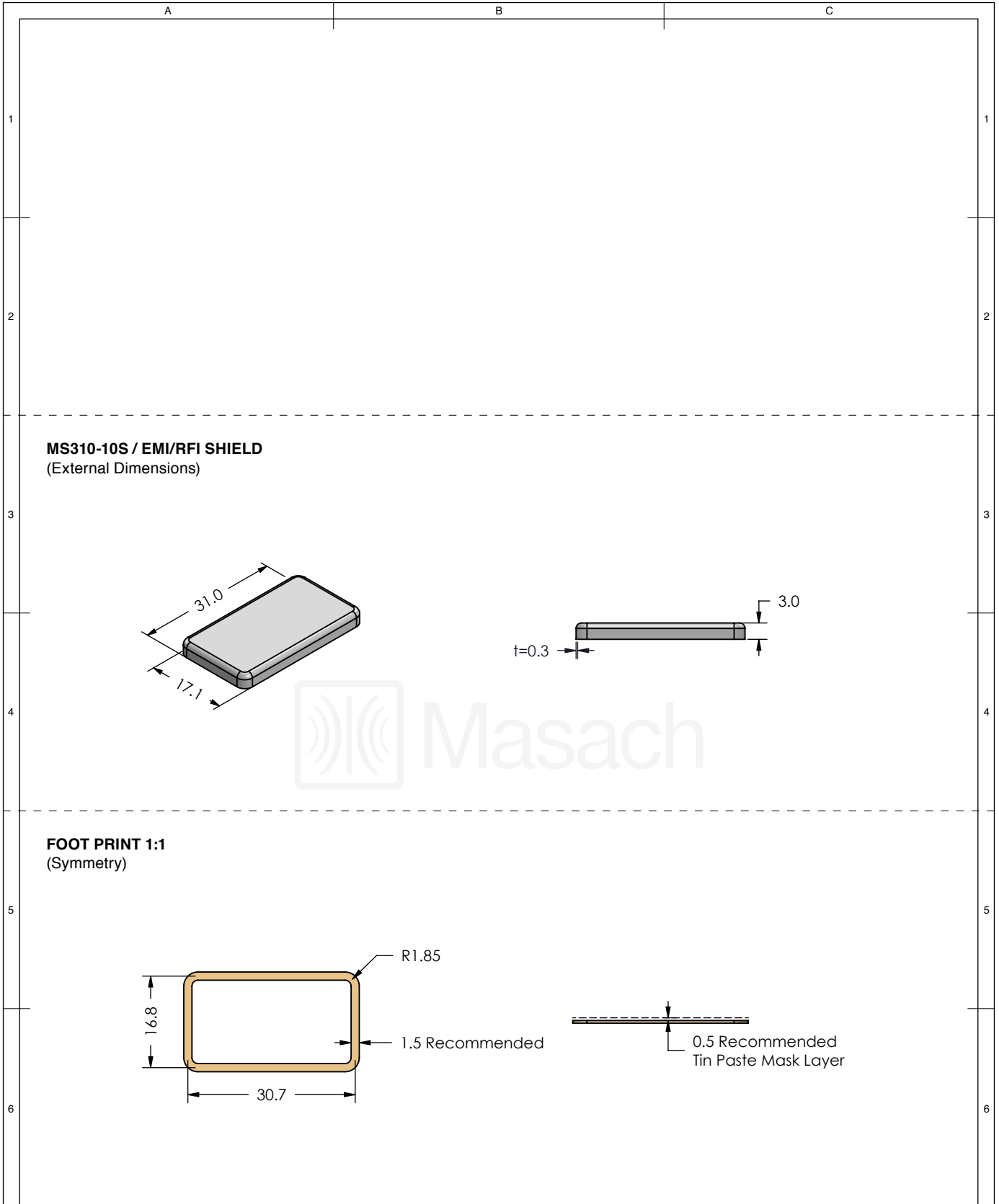

This product has been designed and manufactured by © Masach Tech Ltd. The use of this product in any type of electronic device or application is not under Masach Tech Ltd. liability.

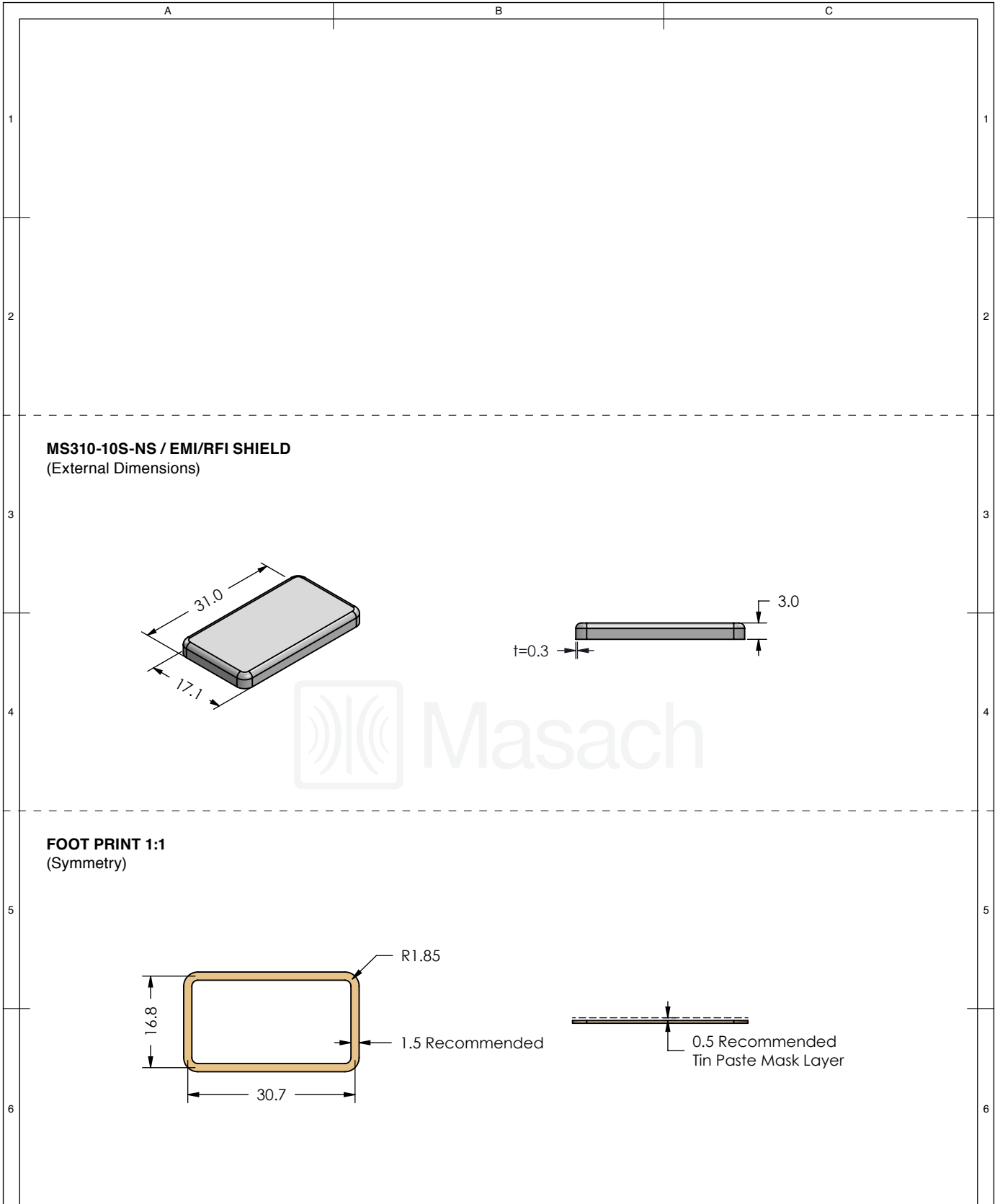

| | | | |
|---|---|--------------------------------|-----------------------------|
| | MS ITEM PN: | DESCRIPTION: | MATERIAL: |
| | MS310-10S | ONE-PIECE EMI/RF SHIELD | TIN PLATED STEEL (1) |
| NOTE: (1) CRS ELECTROLYTIC TINPLATE (2) GENERAL TOLERANCE (+/-) 0.2MM | | | |
| © MASACH TECH LTD. 22 HAGANAN, MODIIN 7169513 ISRAEL T: (+972) 8-9754681 / F: (+972) 8-9754682 info@masach.com / www.masach.com | SHIELD TYPE: | | |
| | SEAMLESS PROTECTIVE EMI/RFI CAGE | | MMGS / PRINT 1:1 / A4 |

This product has been designed and manufactured by © Masach Tech Ltd. The use of this product in any type of electronic device or application is not under Masach Tech Ltd. liability.

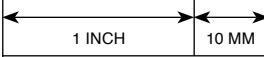

| | | | |
|---|---|---|---|
|  | MS ITEM PN: | DESCRIPTION: | MATERIAL: |
| | MS310-10S-NS | ONE-PIECE EMI/RF SHIELD | NICKEL SILVER (1) |
| NOTE: (1) UNS C77000 / UNS C73500 (2) GENERAL TOLERANCE (+/-) 0.2MM | | | |
| © MASACH TECH LTD. 22 HAGANAN, MODIIN 7169513 ISRAEL T: (+972) 8-9754681 / F: (+972) 8-9754682 info@masach.com / www.masach.com | SHIELD TYPE: |   |  |
| | SEAMLESS PROTECTIVE EMI/RFI CAGE | | MMGS / PRINT 1:1 / A4 |

This product has been designed and manufactured by © Masach Tech Ltd. The use of this product in any type of electronic device or application is not under Masach Tech Ltd. liability.

A

B

C

MS310-10* / SMALL PACKING TRAY / SMD

* COMPATIBLE TO ALL SHIELD CONFIGURATIONS

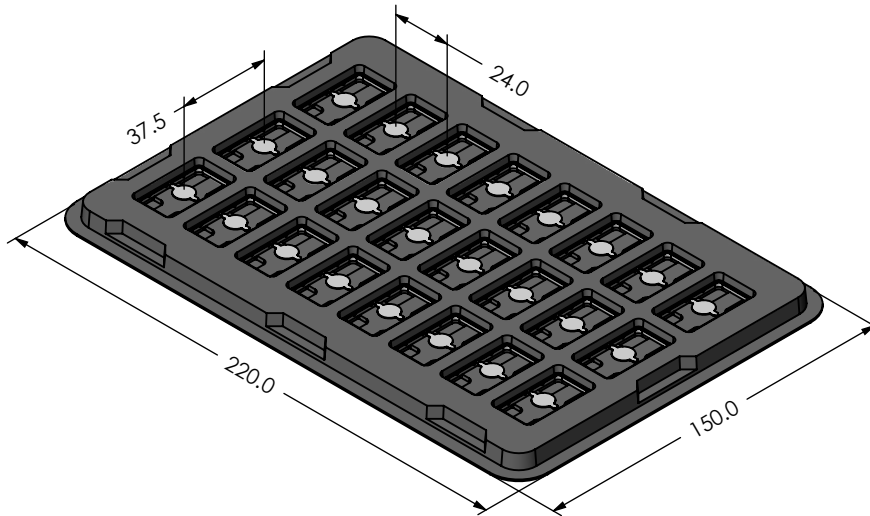

MS310-10* / LARGE PACKING TRAY / SMD

* COMPATIBLE TO ALL SHIELD CONFIGURATIONS

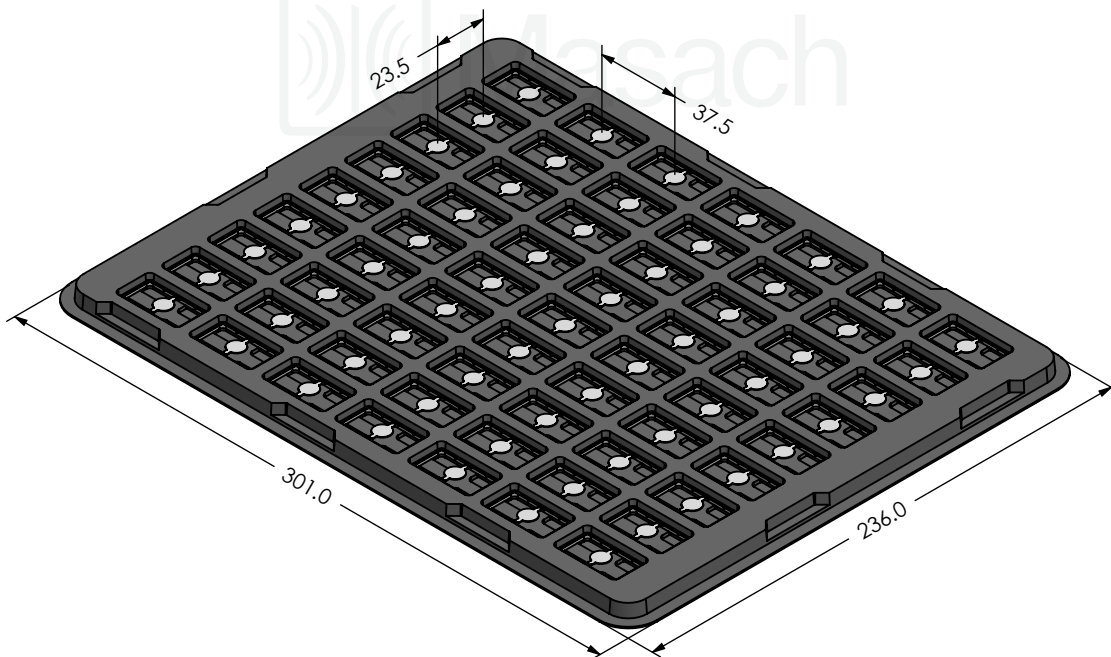

MS PN:

DESCRIPTION:

MATERIAL:

© MASACH TECH LTD.
22 HAGANAN, MODIIN 7169513 ISRAEL
T: (+972) 8-9754681 / F: (+972) 8-9754682
info@masach.com / www.masach.com

SHIELD TYPE:

SEAMLESS PROTECTIVE EMI/RFI CAGE



1 INCH

10 MM

MMGS / PRINT 1:1 / A4

This product has been designed and manufactured by © Masach Tech Ltd. The use of this product in any type of electronic device or application is not under Masach Tech Ltd. liability.

[BACK TO TOP](#)



Компания «ЭлектроПласт» предлагает заключение долгосрочных отношений при поставках импортных электронных компонентов на взаимовыгодных условиях!

Наши преимущества:

- Оперативные поставки широкого спектра электронных компонентов отечественного и импортного производства напрямую от производителей и с крупнейших мировых складов;
- Поставка более 17-ти миллионов наименований электронных компонентов;
- Поставка сложных, дефицитных, либо снятых с производства позиций;
- Оперативные сроки поставки под заказ (от 5 рабочих дней);
- Экспресс доставка в любую точку России;
- Техническая поддержка проекта, помощь в подборе аналогов, поставка прототипов;
- Система менеджмента качества сертифицирована по Международному стандарту ISO 9001;
- Лицензия ФСБ на осуществление работ с использованием сведений, составляющих государственную тайну;
- Поставка специализированных компонентов (Xilinx, Altera, Analog Devices, Intersil, Interpoint, Microsemi, Aeroflex, Peregrine, Syfer, Eurofarad, Texas Instrument, Miteq, Cobham, E2V, MA-COM, Hittite, Mini-Circuits, General Dynamics и др.);

Помимо этого, одним из направлений компании «ЭлектроПласт» является направление «Источники питания». Мы предлагаем Вам помощь Конструкторского отдела:

- Подбор оптимального решения, техническое обоснование при выборе компонента;
- Подбор аналогов;
- Консультации по применению компонента;
- Поставка образцов и прототипов;
- Техническая поддержка проекта;
- Защита от снятия компонента с производства.



Как с нами связаться

Телефон: 8 (812) 309 58 32 (многоканальный)

Факс: 8 (812) 320-02-42

Электронная почта: org@eplast1.ru

Адрес: 198099, г. Санкт-Петербург, ул. Калинина, дом 2, корпус 4, литера А.