



**CONNECTORS
(HIGH VOLTAGE,
HIGH CURRENT,
HYBRIDE)**

**STECKVER-
BINDUNGEN
(HOCH-
SPANNUNG,
HOCHSTROM,
GEMISCHT)**



 **LEMO**



| | | |
|---------------------------------------|-----------|---|
| Bestellbeispiele | 3 | Part number examples |
| Hochspannung | 5 | High voltage |
| Serie Y | 6-7 | Series Y |
| Serie 1Y.3Y | 8 | Series 1Y.3Y |
| Serie B | 9-10 | Series B |
| Serie 0S.1S | 11 | Series 0S.1S |
| Kontaktfiguration | 12-13 | Contactfiguration |
| Hochspannungskabel | 14 | High voltage cable |
| Konfektionierungsanleitung | 15 | Assembling Instructions |
| Technische Informationen | 16 | Technical informations |
| Hochspannungsfest | 17 | High voltage firm |
| Serie S | 18-22 | Series S |
| Serie E | 23-25 | Series E |
| Kontaktfiguration | 26-27 | Contactfiguration |
| Konfektionierungsanleitung | 28 | Assembling Instructions |
| Einpolig Hochstrom | 29 | Unipole high current |
| Serie S | 30-36 | Series S |
| Serie E | 36-39 | Series E |
| Kontaktfiguration | 40 | Contactfiguration |
| Konfektionierungsanleitung | 41 | Assembling instructions |
| Gemischt / Mehrpolig Hochstrom | 43 | Hybride / Multipole high current |
| Serie S | 44-48 | Series S |
| Serie E | 48-51 | Series E |
| Serie B | 51/52 | Series B |
| Serie K | 53/54 | Series K |
| Kontaktfiguration | 55-58 | Contactfiguration |
| PVC-isolierte Kabel | 59 | PVC-insulated Cables |
| Konfektionierungsanleitung | 60 | Assembling Instructions |
| Materialien | 61 | Materials |
| Serie Y | 61 | Series Y |
| Serie B+K | 62 | Series B+K |
| Serie S+E | 63 | Series S+E |
| Spannzangen | 64 | Collets |
| Serie Y | 64 | Series Y |
| Serie B | 65-66 | Series B |
| Serie K | 66-69 | Series K |
| Serie S | 70-76 | Series S |
| Serie E | 77-79 | Series E |
| Zubehör | 80 | Accessories |
| Knickschutztüllen | 80-81 | Bend Relief |
| Schutztüllen | 82 | Overall Bend Relief |



BESTELLBEISPIELE | PART NUMBER EXAMPLES

Straight plug



FFA.1Y.405.CLAC32 = straight plug with cable collet, 1Y series, high voltage 5kV, outer shell in chrome plated brass, PEEK insulator, 1 male solder contact, C type collet for a 3,2 mm diameter cable.

Fixed socket



ERA.1Y.405.CTL = fixed socket, nut fixing, 1Y series, high voltage 5kV, outer shell in chrome plated brass, PTFE insulator, 1 female solder contact.

Fixed coupler



SWH.1S.405 = straight coupler, nut fixing, 1S series, high voltage firm, outer shell in chrome plated brass, PEEK insulator, 1 female contacts each end.

Note:
 "the „Variant“ position in the reference is used to specify either the presence of a collet nut for fitting the bend relief or the anodized colour of the housing in aluminium alloy.
 For models with collet nut for fitting the bend relief, a „Z“ should be indicated and a bend relief can be ordered separately as indicated in the „Accessories“ section. An order for a connector with bend relief should thus include two part numbers.
 For the various housings available in colours, the corresponding letter in the part number for the colour see Unipole/Multipole catalogue.
 For the watertight models of socket, the letter „P“ is used; for the vacuumtight models of socket the letters „PV“ shall be indicated.
 For the plug and socket that should be fitted with an FPM O-ring the letter „H“ shall be indicated.
²⁾Variants see Unipole/Multipole catalogue.

Steckverbindungen

Connectors

Kontaktfiguration

Contactfiguration

Kabel

Cable

Konfektionierungsanleitung

Assembling Instructions

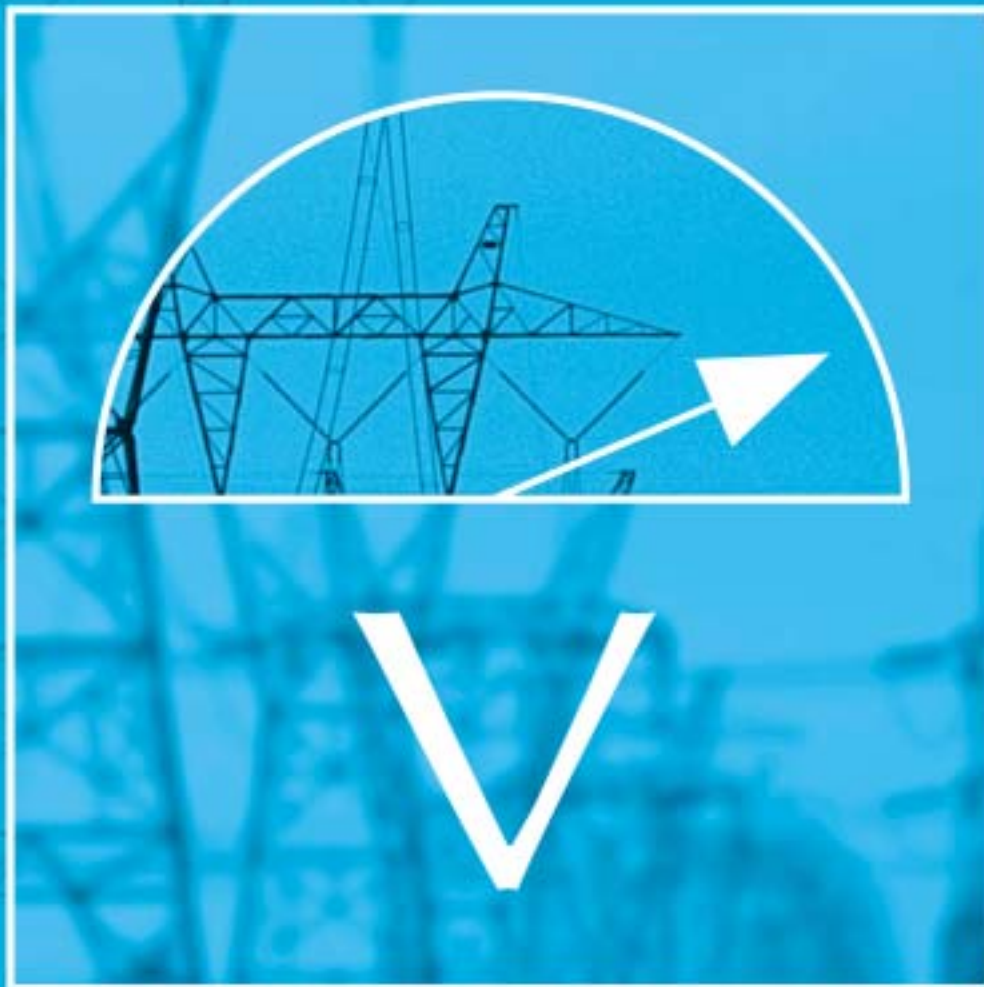

HOCHSPANNUNG
HIGH VOLTAGE



Part number example see page 3



HOCHSPANNUNG | HIGH VOLTAGE
BAUFORM Y-SERIE | MODEL Y-SERIES

ERA Fixed socket, nut fixing

| Reference | | | Dimensions L (mm) | |
|-----------|--------|-------|-------------------|----------------|
| Model | Series | Type | male contact | female contact |
| ERA | 3Y | 415 ✓ | 77 | 109 |
| ERA | 3Y | 430 ✓ | 108 | 150 |



ERA.3Y.260.CZZ Microswitch for fitting onto fixed socket



PSA Fixed socket, nut fixing, with cable collet

| Reference | | | Dimensions L (mm) | |
|-----------|--------|-------|-------------------|----------------|
| Model | Series | Type | male contact | female contact |
| PSA | 3Y | 430 ✓ | - | 146 |



FFB.6Y Straight plug with cable collet and safety nut

50 kV Version, technische Daten auf Anfrage.
 50 kV version, technical informations on request.

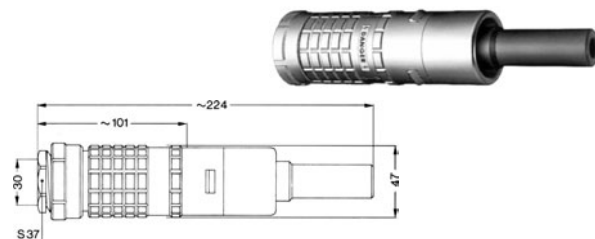

ERA.6Y Fixed socket, nut fixing

50 kV Version, technische Daten auf Anfrage.
 50 kV version, technical informations on request.



HOCHSPANNUNG | HIGH VOLTAGE
BAUFORM 1Y.3Y-SERIE | MODEL 1Y.3Y-SERIES



FFR Straight plug for cable crimping, with bend relief and safety ring

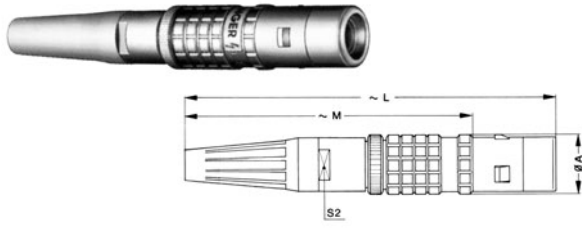

| Reference | | Dimensions (mm) | | | |
|-----------|--------|-----------------|-----|----|----|
| Model | Series | A | L | M | S2 |
| FFR | 1Y ✓ | 13 | 83 | 65 | 9 |
| FFR | 3Y ✓ | 19 | 114 | 84 | 15 |

ERA Fixed socket, nut fixing



| Reference | | Dimensions (mm) | | | | | | | |
|-----------|--------|-----------------|------|---------|----|----|-----|------|----|
| Model | Series | A | B | e | E | L | M | S1 | S3 |
| ERA | 1Y ✓ | 20 | 22.0 | M16x1.0 | 8 | 34 | 4.5 | 14.5 | 19 |
| ERA | 3Y ✓ | 31 | 34.5 | M24x1.0 | 12 | 50 | 6.5 | 22.5 | 30 |

PEP Fixed socket, nut fixing, with cable collet nut (back panel mounting)

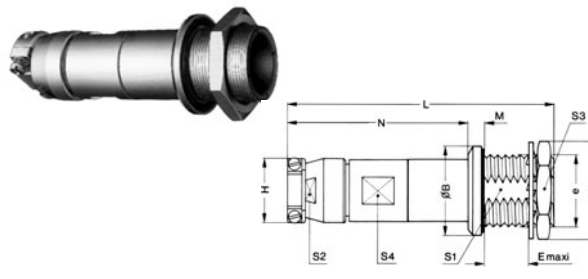

| Reference | | Dimensions (mm) | | | | | | | | | | | |
|-----------|--------|-----------------|----|---------|----|----|----|-----|----|------|----|----|----|
| Model | Series | A | B | e | E | H | L | M | N | S1 | S2 | S3 | S4 |
| PEP | 3Y ✓ | 35 | 31 | M24x1.0 | 13 | 24 | 86 | 3.5 | 62 | 22.5 | 20 | 30 | 20 |

VCP Fixed socket, nut fixing, with key, vacuumtight (back panel mounting)

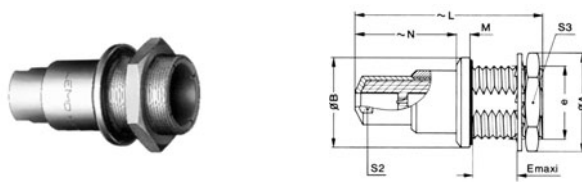

| Reference | | Dimensions (mm) | | | | | | | | |
|-----------|--------|-----------------|------|---------|----|----|-----|----|----|----|
| Model | Series | A | B | e | E | L | M | N | S2 | S3 |
| VCP | 1Y | 20 | 22.0 | M16x1.0 | 8 | 42 | 3.0 | 24 | 9 | 19 |
| VCP | 3Y ✓ | 31 | 34.5 | M24x1.0 | 12 | 60 | 3.5 | 36 | 15 | 30 |

Note: HGP (flange version)
 VPP (watertight version)



Part number example see page 3



HOCHSPANNUNG | HIGH VOLTAGE
BAUFORM B-SERIE | MODEL B-SERIES

FCJ Straight plug with cable clamp and safety ring, keyway (J)

| Reference | | Dimensions (mm) | | | | | |
|-----------|--------|-----------------|----|-----|----|----|----|
| Model | Series | A | H | L | M | S1 | S2 |
| FCJ | 4B ✓ | 25 | 24 | 77 | 59 | 21 | 20 |
| FCJ | 5B ✓ | 35 | 34 | 107 | 82 | 31 | 30 |

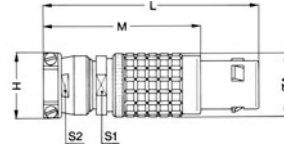

EGJ Fixed socket, nut fixing, with keyway (J)

| Reference | | Dimensions (mm) | | | | | | | |
|-----------|--------|-----------------|----|---------|------|----|-----|------|----|
| Model | Series | A | B | e | E | L | M | S1 | S3 |
| EGJ | 4B ✓ | 28 | 32 | M25x1.0 | 12.5 | 38 | 2.5 | 23.5 | 30 |
| EGJ | 5B ✓ | 40 | 40 | M35x1.0 | 11.0 | 43 | 3.0 | 33.5 | - |

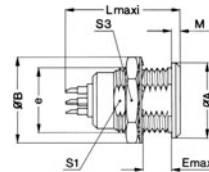

ECJ Fixed socket, with two nuts and keyway (J) (back panel mounting)

| Reference | | Dimensions (mm) | | | | | | | | |
|-----------|--------|-----------------|----|---------|------|----|-----|------|----|----|
| Model | Series | A | B | e | E | L | M | S1 | S3 | S4 |
| ECJ | 4B ✓ | 30 | 32 | M25x1.0 | 10.5 | 38 | 4.5 | 23.5 | 27 | 27 |
| ECJ | 5B | 41 | 40 | M35x1.0 | 9.0 | 43 | 5.0 | 33.5 | 37 | 37 |

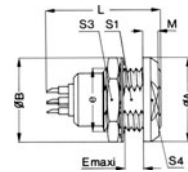

PFJ Fixed socket, with two nuts cable clamp and keyway (J) (back panel mounting)

| Reference | | Dimensions (mm) | | | | | | | | | | |
|-----------|--------|-----------------|----|---------|------|----|-----|-----|------|----|----|----|
| Model | Series | A | B | e | E | H | L | M | S1 | S2 | S3 | S4 |
| PFJ | 4B ✓ | 30 | 32 | M25x1.0 | 10.5 | 24 | 75 | 4.5 | 23.5 | 20 | 30 | 27 |
| PFJ | 5B ✓ | 41 | 40 | M35x1.0 | 9.0 | 34 | 103 | 5.0 | 33.5 | 30 | - | 37 |



HOCHSPANNUNG | HIGH VOLTAGE
BAUFORM B-SERIE | MODEL B-SERIES



PHJ Free socket with cable clamp and keyway (J)



| Reference | | Dimensions (mm) | | | | |
|-----------|--------|-----------------|----|-----|----|----|
| Model | Series | A | H | L | S1 | S2 |
| PHJ | 4B ✓ | 24.4 | 24 | 75 | 21 | 20 |
| PHJ | 5B ✓ | 34.2 | 34 | 103 | 31 | 31 |

**VEJ Fixed socket, nut fixing, with keyway (J)
vacuumtight (back panel mounting)**



| Reference | | Dimensions (mm) | | | | | | | | | | |
|-----------|--------|-----------------|----|----|----|-------|-------|----|-----|------|------|----|
| Model | Series | A | B | C | E | e | e1 | L | M | N | S1 | S3 |
| VEJ | 4B ✓ | 32 | 32 | 25 | 13 | M25x1 | M22x1 | 58 | 3.5 | 34.5 | 23.5 | 30 |
| VEJ | 5B | 40 | 45 | 34 | 13 | M35x1 | M30x1 | 73 | 5.0 | 42.0 | 33.5 | - |

**VPJ Fixed socket, nut fixing, with cable clamp and keyway (J)
vacuumtight (back panel mounting)**



| Reference | | Dimensions (mm) | | | | | | | | | | | | |
|-----------|--------|-----------------|----|----|----|-------|----|-----|-----|------|------|----|----|----|
| Model | Series | A | B | C | E | e | H | L | M | N | S1 | S2 | S3 | S4 |
| VPJ | 4B ✓ | 32 | 32 | 25 | 13 | M25x1 | 24 | 91 | 3.5 | 67.5 | 23.5 | 20 | 30 | 21 |
| VPJ | 5B | 40 | 45 | 34 | 13 | M35x1 | 34 | 112 | 5.0 | 81.0 | 33.5 | 30 | - | 31 |

BAUFORM 0S.1S-SERIE | MODEL 0S.1S-SERIES

FFR Straight plug for cable crimping with safety ring

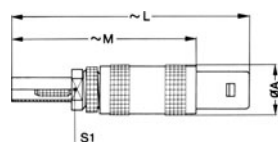

| Reference | | Dimensions (mm) | | | |
|-----------|--------|-----------------|----|----|-----|
| Model | Series | A | L | M | S1 |
| FFR | 0S ✓ | 9 | 42 | 32 | 6.5 |
| FFR | 1S ✓ | 12 | 53 | 42 | 8.5 |



Part number example see page 3



HOCHSPANNUNG | HIGH VOLTAGE
BAUFORM 0S.1S-SERIE | MODEL 0S.1S-SERIES

ERA Fixed socket, nut fixing

| Reference | | Dimensions (mm) | | | | | | | |
|-----------|--------|-----------------|------|---------|---|----|-----|------|----|
| Model | Series | A | B | e | E | L | M | S1 | S3 |
| ERA | 0S ✓ | 10 | 12.5 | M9x0.6 | 7 | 25 | 1.2 | 8.2 | 11 |
| ERA | 1S ✓ | 14 | 16.0 | M12x1.0 | 7 | 30 | 1.5 | 10.5 | 14 |



PCS Free socket for cable crimping

| Reference | | Dimensions (mm) | | |
|-----------|--------|-----------------|----|-----|
| Model | Series | A | L | S1 |
| PCS | 0S ✓ | 9 | 38 | 6.5 |
| PCS | 1S ✓ | 12 | 52 | 8.5 |



PSS Fixed socket for cable crimping, nut fixing

| Reference | | Dimensions (mm) | | | | | | | | |
|-----------|--------|-----------------|------|---------|---|----|-----|------|-----|----|
| Model | Series | A | B | e | E | L | M | S1 | S2 | S3 |
| PSS | 0S ✓ | 10 | 12.5 | M9x0.6 | 7 | 38 | 1.2 | 8.2 | 6.5 | 11 |
| PSS | 1S ✓ | 14 | 16.0 | M12x1.0 | 7 | 52 | 1.5 | 10.5 | 8.5 | 14 |



EWB Fixed socket, nut fixing, vacuumtight

| Reference | | Dimensions (mm) | | | | | | | |
|-----------|--------|-----------------|------|---------|----|----|-----|----|----|
| Model | Series | A | B | e | E | L | M | S3 | S4 |
| EWB | 0S ✓ | 13 | 12.5 | M9x0.6 | 10 | 34 | 3.5 | 9 | 11 |
| EWB | 1S ✓ | 18 | 16.0 | M12x1.0 | 10 | 40 | 4.0 | 11 | 14 |



HOCHSPANNUNG | HIGH VOLTAGE

KONTAKTFIGURATION SERIE Y | CONTACTFIGURATION SERIES Y



| Soldersided seen | | Order-No. | Size | Number of contacts | Contact- \varnothing | Dielectric- \varnothing max. | Conductor- \varnothing max. | Supply voltage ² (kV =) DC | Supply voltage ² (kV ~) AC | Test voltage ³ (kV =) DC | Test voltage ³ (kV ~) AC | Rated current ⁴ |
|------------------|----------------|-----------|------|--------------------|------------------------|--------------------------------|-------------------------------|--|--|--|--|----------------------------|
| Male contact | Female contact | | | | | | | | | | | |
| | | 405 | 1 | 1 | 1.3 | 3.2 | 1.45 | 7 | 5.0 | 10.5 | 7.5 | 8 |
| | | 410 | 1 | 1 | 1.3 | 3.2 | 1.45 | 10 | 7.0 | 15.0 | 10.5 | 8 |
| | | 415 | 3 | 1 | 4.5 | 7.3 | 2.45 | 15 | 10.5 | 22.5 | 16.0 | 15 |
| | | 430 | 3 | 1 | 4.5 | 7.3 | 2.45 | 30 | 21.0 | 45.0 | 32.0 | 15 |
| | | 450 | 6 | 1 | 7.0 | 23 | 6.6 | 50 | - | 70 | - | 25 |

BAUFORM 1Y.3Y-SERIE | MODEL 1Y.3Y-SERIES

| Soldersided seen | | Order-No. | Size | Number of contacts | Contact- \varnothing | Supply voltage ¹ (kVrms) | Supply voltage ¹ (kV dc) | Supply voltage ² (kVrms) | Supply voltage ² (kV dc) | Test voltage ³ (kVrms) | Test voltage ³ (kV dc) | Rated current ⁴ |
|------------------|----------------|-----------|------|--------------------|------------------------|--|--|--|--|--------------------------------------|--------------------------------------|----------------------------|
| Male contact | Female contact | | | | | | | | | | | |
| | | 416 | 1 | 1 | 0.9 | 11.2 | 16 | 16.0 | 23 | 25 | 35 | 6 |
| | | 425 | 3 | 1 | 1.6 | 17.5 | 25 | 24.5 | 35 | 37 | 52 | 8 |

BAUFORM 0S.1S-SERIE | MODEL 0S.1S-SERIES

| | | | | | | | | | | | | |
|--|--|-----|---|---|-----|-----|---|-----|----|------|----|---|
| | | 405 | 0 | 1 | 0.7 | 3.5 | 5 | 5.6 | 8 | 8.5 | 12 | 4 |
| | | 408 | 1 | 1 | 0.9 | 5.6 | 8 | 8.5 | 12 | 12.7 | 18 | 6 |



Part number example see page 3



HOCHSPANNUNG | HIGH VOLTAGE
KONTAKTFIGURATION SERIE B | CONTACTFIGURATION SERIES B

| Soldersided seen | | Order-No. | Size | Number of contacts | Contact-ø mm | Supply voltage ¹ (kV rms) | Supply voltage ¹ (kV dc) | Supply voltage ² (kV rms) | Supply voltage ² (kV dc) | Test voltage ³ (kV rms) | Test voltage ³ (kV dc) | Rated current ⁴ A |
|------------------|----------------|-----------|------|--------------------|-----------------|---|--|---|--|---------------------------------------|--------------------------------------|---------------------------------|
| Male contact | Female contact | | | | | | | | | | | |
| | | 460 | 4 | 10 | 0.9 | 3.5 | 5 | 5.6 | 8 | 8.5 | 12 | 3 |
| | | 464 | 4 | 4 | 0.9 | 5.6 | 8 | 8.5 | 12 | 12.7 | 18 | 4 |
| | | 467 | 4 | 7 | 0.9 | 5.6 | 8 | 8.5 | 12 | 12.7 | 18 | 4 |
| | | 474 | 5 | 14 | 0.9 | 5.6 | 8 | 8.5 | 12 | 12.7 | 18 | 4 |
| | | 481 | 5 | 21 | 0.9 | 5.6 | 8 | 8.5 | 12 | 12.7 | 18 | 4 |

Test norms:

¹ IEC 130.1 §14.5 a) $U_s = \frac{U_e - 1.5}{2}$

² IEC 130.1 §14.5 b) $U_s = \frac{U_e}{1.5}$

³ MIL





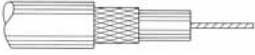

⁴ IEC 512-3

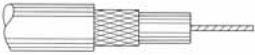

Special LEMO-HV-cables with small outer diameters matching exactly our LEMO-HV-connectors

| | Lead Time | | Suitable Size | Price | Order-No. |
|--|-----------|------|---------------|-------|-----------|
| | Stk. | Req. | | €/m | |
|  | x | - | 0-2 | 0.41 | 140 470 |

| Conductor resistance | Insulation resistance | Operating Voltage U_{max} | Testing Voltage U_{max} | Temperature range | | Inner conductor | | | Insulation | | Outer sheath | |
|----------------------|-----------------------|-----------------------------|---------------------------|-------------------|-------|-----------------|---------|------|------------|------|--------------|----------|
| | | | | from | to | Mat. | Struct. | Ø | Mat. | Ø | Mat. | Ø (±0,2) |
| | | | | Ω/km | MΩ/km | kV dc | kV dc | °C | °C | | | mm |
| 50.0 | 104 | 3 | 5 | -15 | +70 | Cu Sn | 7x0.25 | 0.75 | PE wt | 2.05 | PVC | 3.0 |

| | Lead Time | | Suitable Size | Price | Order-No. |
|--|-----------|------|---------------|-------|----------------------|
| | Stk. | Req. | | €/m | |
|  | x | - | 0-2 | 1.00 | 150 470 |
|  | x | - | 1-3 | 0.87 | 106 330 |
|  | x | - | 3-5 | 1.72 | 315 650 |
|  | x | - | 1-4 | 1.52 | 130 660 |
|  | - | x | 1-4 | 2.22 | 130666 ¹ |
|  | x | - | 2-4 | 7.54 | 201 340 ¹ |

| Capacitance | Conductor resistance | Insulation resistance | Operating Voltage U_{max} | Testing Voltage U_{max} | Temperature range | | Inner conductor | | | Insulation | | Screen | | Outer sheath | |
|-------------|----------------------|-----------------------|-----------------------------|---------------------------|-------------------|------|-----------------|---------|-------|------------|------|--------|------|--------------|-----------------|
| | | | | | from | to | Mat. | Struct. | Ø | Mat. | Ø | Mat. | Ø | Mat. | Ø (±0,2) |
| | | | | | pF/m | Ω/km | MΩ/km | kV dc | kV dc | °C | °C | | | mm | mm |
| 83.1 | 38.2 | 220 | 3 | 6 | -5 | +70 | Cu bl | 7x0.25 | 0.75 | PE nat | 2.05 | Cu bl | 2.4 | PVCrd | 4.0 |
| 84.0 | 77.5 | 5,000 | 9 | 18 | -10 | +70 | Cu bl | 14x0.15 | 0.60 | PE nat | 2.80 | Cu bl | 3.5 | PVCrd | 4.6 |
| 85.0 | 15.0 | 5,000 | 18 | 25 | -10 | +70 | Cu blk | - | 1.50 | PE nat | 6.50 | Cu bl | 7.3 | PVCgr | 8.8 |
| 82.7 | 55.8 | 5,000 | 30 | 60 | -25 | +90 | Cu Sn | 7x0.25 | 0.75 | PErd | 3.90 | Cu bl | 4.4 | PVCrd | 5.4 (+0.2/-0.0) |
| 82.7 | 55.8 | 5,000 | 30 | 60 | -25 | +90 | Cu Sn | 7x0.25 | 0.75 | PErd | 3.90 | Cu bl | 4.4 | PVCrd | 6±0,1 |
| - | 56.1 | 1,000 | 50 | 75 | -20 | +105 | Cu Sn | 7x0.25 | 0.75 | PE nat | 3.15 | Cu Sn | 5.45 | PVCrd | 7.25 |

¹ Note: High voltage cable according to UL-style

¹ Hochspannungskabel gemäß UL-Ausführung



HOCHSPANNUNG | HIGH VOLTAGE KONFEKTIONIERUNGSANLEITUNG | ASSEMBLING INSTRUCTIONS



| Reference | | | Unisolated length (mm) | | |
|-----------|--------|------|------------------------|----|----|
| Model | Series | Type | A | B | C |
| FFA | 1Y | 405 | 8 | 28 | 34 |
| FFA | 1Y | 405X | 8 | 26 | 31 |
| PSA | 1Y | 405 | size on request | | |
| PSA | 1Y | 405X | size on request | | |
| FFA | 1Y | 410 | 8 | 34 | 40 |
| FFA | 1Y | 410X | 8 | 34 | 40 |
| PSA | 1Y | 410 | 8 | 33 | 40 |
| PSA | 1Y | 410X | 8 | 33 | 40 |
| FFA | 3Y | 415 | 15 | 62 | 72 |
| FFA | 3Y | 415X | 7 | 32 | 43 |
| PSA | 3Y | 415 | size on request | | |
| PSA | 3Y | 415X | size on request | | |
| FFA | 3Y | 430 | 14 | 82 | 92 |
| FFA | 3Y | 430X | 12 | 88 | 95 |
| PSA | 3Y | 430 | 8 | 40 | 50 |
| PSA | 3Y | 430X | size on request | | |

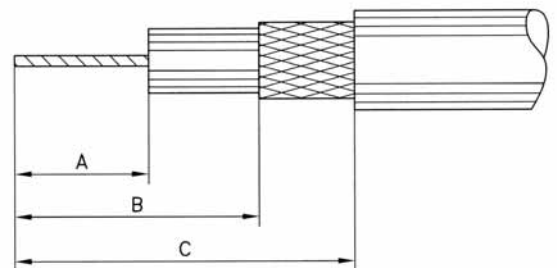

Note: The dimensions are standard values and may vary depending on the cable quality.

Die Abmessungen sind Richtwerte und können sich je nach Kabelqualität ändern.

TECHNISCHE INFORMATIONEN | TECHNICAL INFORMATION

SERIE Y | SERIES Y



| | |
|---|---|
| Die Hochspannungsserie Y besitzt das LEMO Push-Pull Verriegelungssystem mit hohem Sicherheitsfaktor. | The high voltage Y-series with the LEMO Push-Pull Self Latching Connection System provides high security. |
| <ul style="list-style-type: none"> Stecker und Buchse sind mit männlichen oder weiblichen Kontakten lieferbar. | <ul style="list-style-type: none"> Plug and socket are available with male or female contacts. |
| <ul style="list-style-type: none"> Die Luft- und Kriechstrecken sind nach DIN EN 61010 gewährleistet. | <ul style="list-style-type: none"> The creepage distance and air clearance are guaranteed according to DIN EN 61010. |
| <ul style="list-style-type: none"> Einfache Kabelmontage. | <ul style="list-style-type: none"> Simple cable assembly. |
| <ul style="list-style-type: none"> Die Serie Y ist für gepulste Spannungen geeignet, auf Wunsch führen wir einen Langzeittest exakt nach Ihren Spannungsverhältnissen durch. | <ul style="list-style-type: none"> The Y-series is appropriate for pulsed voltage, on request long-term tests are conducted exactly according to your voltage ratio. |



Fixed socket

- 1) outer shell
- 2) earthing crown
- 3) castellated ring
- 4) hexagonal nut
- 5) locking ring
- 6) insulator
- 7) female contact
- 8) sealing ring

Straight plug

- 1) outer shell
- 2) inner shell
- 3) latch sleeve
- 4) collet nut
- 5) centre-piece
- 6) insulator
- 7) male contact
- 8) circlip
- 9) collet

Electrical Datas

| Characteristic | Units | Series | | | | | Standards | Methode |
|------------------------|--------|-------------------|--------|--------|--------|--------|---------------|---------|
| | | 1Y.405 | 1Y.410 | 3Y.415 | 3Y.430 | 6Y.450 | | |
| Operating Voltage | kV dc | 7 | 10 | 15 | 30 | 50 | IEC 130.1 | |
| | kV eff | 5 | 7 | 10.5 | 21 | - | | |
| Contact resistance | mΩ | <3 | <3 | <2 | <2 | <0.4 | MIL-STD-202 | 307 |
| Insulations resistance | Ω | >10 ¹² | | | | | MIL-STD-1344A | 3003.1 |

Mechanical Datas and Temperature Informations

| Characteristic | Units | Series | | | Standards | Methode |
|--------------------------|--------|---------------------------|------|------|---------------|---------|
| | | 1Y | 3Y | 6Y | | |
| Contact-pullout strength | N | <24 | <60 | - | MIL-STD-1344A | 2007.1 |
| Cable-tensile strength | N | <300 | <550 | <800 | MIL-STD-1344A | 2009.1 |
| Mechanical Lifetime | Cycles | <1000 | | | MIL-STD-1344A | 2016 |
| | °C | -55 +230 (-67 °F +446 °F) | | | | |

Panel Cut out

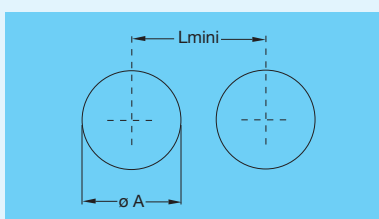

| Series | Dimensions (mm) | | Torque (Nm) |
|--------|-----------------|------|-------------|
| | øA | L | |
| 1Y | 16.1 | 22.0 | 14 |
| 3Y | 24.2 | 35.5 | 25 |
| 6Y | 55.3 | 67.5 | 55 |

Zubehörteile und Werkzeuge siehe Unipole/Multipole Katalog.
Accessories and Tools see Unipole/Multipole Catalogue.

1N = 0.102 Kg

**Steckverbindungen
Connectors
Kontaktfiguration
Contactfiguration
Konfektionierungsanleitung
Assembling Instructions**



**HOCHSPANNUNGSFEST
HIGH VOLTAGE FIRM**

HOCHSPANNUNGSFEST | HIGH VOLTAGE FIRM
BAUFORM S-SERIE | MODEL S-SERIES



FFA Straight plug, cable collet

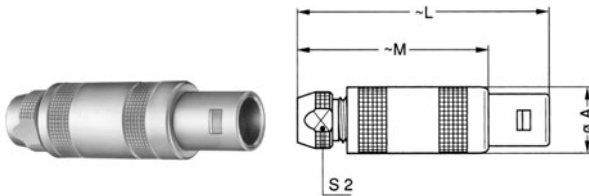

| Reference | | Dimensions (mm) | | | |
|-----------|--------|-----------------|-------|------|------|
| Model | Series | A | L | M | S2 |
| FFA | 0S | 9.0 | 34.5 | 24.5 | 6.5 |
| FFA | 1S ✓ | 12.0 | 42.5 | 31.5 | 8.5 |
| FFA | 2S | 14.8 | 52.0 | 40.0 | 11.0 |
| FFA | 3S ✓ | 17.8 | 61.0 | 46.0 | 14.0 |
| FFA | 4S ✓ | 24.8 | 77.0 | 59.0 | 19.0 |
| FFA | 5S ✓ | 35.1 | 103.0 | 78.0 | 29.0 |

FFA Straight plug with oversize cable collet

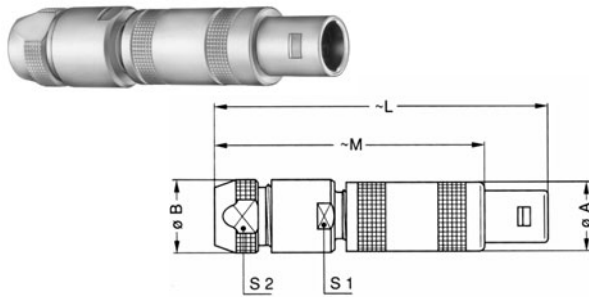

| Reference | | Dimensions (mm) | | | | | |
|-----------|--------|-----------------|------|-------|-------|------|------|
| Model | Series | A | B | L | M | S1 | S2 |
| FFA | 0S ✓ | 9.0 | 10.0 | 45.5 | 35.5 | 9.0 | 8.5 |
| FFA | 1S ✓ | 12.0 | 13.0 | 57.0 | 46.0 | 12.0 | 11.0 |
| FFA | 2S ✓ | 14.8 | 18.0 | 67.0 | 55.0 | 14.0 | 14.0 |
| FFA | 3S ✓ | 17.8 | 21.0 | 85.0 | 70.0 | 19.0 | 19.0 |
| FFA | 4S ✓ | 24.8 | 31.8 | 107.0 | 89.0 | 28.5 | 29.0 |
| FFA | 5S ✓ | 35.1 | 41.8 | 138.0 | 113.0 | 37.5 | 38.0 |

Note: the fitting of oversize collets onto this model allows them to be fitted to the cables that can be accommodated by the next housing size up

FFA Straight plug, cable collet and nut for fitting a bend relief

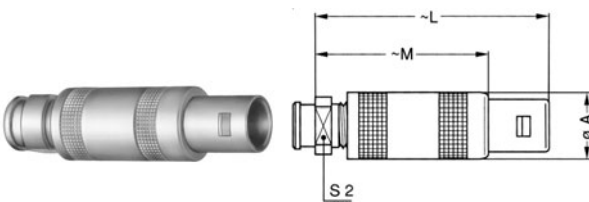

| Reference | | Dimensions (mm) | | | |
|-----------|--------|-----------------|------|------|----|
| Model | Series | A | L | M | S2 |
| FFA | 0S ✓ | 9.0 | 34.5 | 24.5 | 7 |
| FFA | 1S ✓ | 12.0 | 42.5 | 31.5 | 9 |
| FFA | 2S ✓ | 14.8 | 52.0 | 40.0 | 12 |
| FFA | 3S ✓ | 17.8 | 61.0 | 46.0 | 14 |
| FFA | 4S ✓ | 24.8 | 77.0 | 59.0 | 20 |

Note: the bend relief must be ordered separately (see page 80)

FFP Straight plug, cable collet and inner anti-rotating device

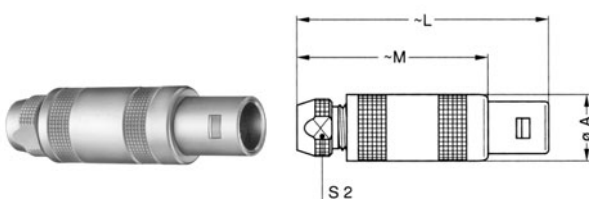

| Reference | | Dimensions (mm) | | | |
|-----------|--------|-----------------|------|------|------|
| Model | Series | A | L | M | S2 |
| FFP | 0S | 9.0 | 34.5 | 24.5 | 6.5 |
| FFP | 1S | 12.0 | 42.5 | 31.5 | 8.5 |
| FFP | 2S | 14.8 | 52.0 | 40.0 | 11.0 |
| FFP | 3S ✓ | 17.8 | 61.0 | 46.0 | 14.0 |
| FFP | 4S | 24.8 | 77.0 | 59.0 | 19.0 |



Part number example see page 3



HOCHSPANNUNGSFEST | HIGH VOLTAGE FIRM BAUFORM S-SERIE | MODEL S-SERIES

FFB Straight plug, cable collet and safety locking ring

| Reference | | Dimensions (mm) | | | |
|-----------|--------|-----------------|------|------|------|
| Model | Series | A | L | M | S2 |
| FFB | 0S ✓ | 9.0 | 36.8 | 26.8 | 6.5 |
| FFB | 1S ✓ | 12.0 | 45.0 | 34.0 | 8.5 |
| FFB | 2S ✓ | 14.8 | 55.5 | 43.5 | 11.0 |
| FFB | 3S ✓ | 17.8 | 65.0 | 50.0 | 14.0 |



FFB Straight plug, cable collet and safety locking ring and nut for fitting a bend relief

| Reference | | Dimensions (mm) | | | |
|-----------|--------|-----------------|------|------|----|
| Model | Series | A | L | M | S2 |
| FFB | 0S | 9.0 | 36.8 | 26.8 | 7 |
| FFB | 1S ✓ | 12.0 | 45.0 | 34.0 | 9 |
| FFB | 2S | 14.8 | 55.5 | 43.5 | 12 |
| FFB | 3S | 17.8 | 65.0 | 50.0 | 14 |



Note: series 0S, 2S and 3S are available on request
the bend relief must be ordered separately (see page 80)

FZP Straight plug for remote handling, cable collet and inner anti-rotating device

| Reference | | Dimensions (mm) | | | | | |
|-----------|--------|-----------------|-------|------|----|------|----|
| Model | Series | A | L | M | N | S2 | S3 |
| FZP | 1S | 16 | 42.5 | 31.5 | 15 | 8.5 | 12 |
| FZP | 2S ✓ | 24 | 52.0 | 40.0 | 21 | 11.0 | 18 |
| FZP | 3S ✓ | 24 | 61.0 | 46.0 | 24 | 14.0 | 18 |
| FZP | 4S | 35 | 77.0 | 59.0 | 30 | 19.0 | 28 |
| FZP | 5S | 43 | 103.0 | 78.0 | 44 | 29.0 | 35 |
| FZP | 6S | 60 | 106.0 | 81.0 | 44 | 38.0 | 50 |



FAA Fixed plug non-latching, nut fixing

| Reference | | Dimensions (mm) | | | | | | | | | |
|-----------|--------|-----------------|------|---------|-----|------|----------------|----------------|------|------|----|
| Model | Series | A | B | e | E | L | L ¹ | L ² | M | S1 | S3 |
| FAA | 0S ✓ | 10 | 12.5 | M9x0.6 | 2.0 | 18.5 | 18.0 | 26,3 | 11.2 | 8.2 | 11 |
| FAA | 1S ✓ | 14 | 16.0 | M12x1.0 | 2.5 | 22.5 | 21.7 | 33,5 | 12.5 | 10.5 | 14 |
| FAA | 2S | 18 | 19.5 | M15x1.0 | 4.0 | 25.0 | 25.3 | 43,0 | 13.8 | 13.5 | 17 |
| FAA | 3S ✓ | 22 | 25.2 | M18x1.0 | 4.0 | 31.0 | 29.0 | 49,0 | 17.0 | 16.5 | 22 |
| FAA | 4S | 28 | 32.0 | M25x1.0 | 2.5 | 35.5 | 39.0 | - | 20.5 | 23.5 | 30 |
| FAA | 5S | 40 | 40.0 | M35x1.0 | 2.5 | 45.0 | - | - | 28.0 | 33.5 | - |



Note: ¹ unipole model
2 high voltage

✓ Bei Lemo vorhanden | available at Lemo

HOCHSPANNUNGSFEST | HIGH VOLTAGE FIRM
BAUFORM S-SERIE | MODEL S-SERIES



FLA Elbow (90°) plug, cable collet



| Reference | | Dimensions (mm) | | | | | | |
|-----------|--------|-----------------|----|------|------|------|----|------|
| Model | Series | A | A1 | H | L | M | S1 | S2 |
| FLA | 0S ✓ | 13 | 13 | 24.5 | 23.0 | 13.0 | 8 | 6.5 |
| FLA | 1S | 16 | 16 | 28.5 | 26.5 | 15.5 | 10 | 8.5 |
| FLA | 2S ✓ | 20 | 20 | 37.0 | 31.0 | 19.0 | 13 | 11.0 |
| FLA | 3S ✓ | 21 | 21 | 44.0 | 38.5 | 23.5 | 15 | 14.0 |
| FLA | 4S | 28 | 28 | 56.0 | 49.0 | 31.0 | 20 | 19.0 |
| FLA | 5S ✓ | - | 37 | 76.5 | 65.0 | 40.0 | 30 | 29.0 |

Note: fig. 1 is used for the unipole type. fig. 2 is used for the multipole type

ERA Fixed socket, nut fixing



| Reference | | Dimensions (mm) | | | | | | | | | |
|-----------|--------|-----------------|------|---------|------|------|------|----------------|-----|------|----|
| Model | Series | A | B | ø | E | L | L' | L ² | M | S1 | S3 |
| ERA | 0S ✓ | 10 | 12.5 | M9x0.6 | 7.0 | 17.5 | 18.5 | 24,6 | 1.2 | 8.2 | 11 |
| ERA | 1S ✓ | 14 | 16.0 | M12x1.0 | 7.5 | 20.2 | 21.5 | 32,0 | 1.5 | 10.5 | 14 |
| ERA | 2S ✓ | 18 | 19.5 | M15x1.0 | 8.5 | 24.5 | 26.0 | 41,4 | 1.8 | 13.5 | 17 |
| ERA | 3S ✓ | 22 | 25.2 | M18x1.0 | 11.5 | 32.0 | 30.0 | 52,0 | 2.0 | 16.5 | 22 |
| ERA | 4S ✓ | 28 | 32.0 | M25x1.0 | 12.0 | 34.0 | 36.0 | 56,7 | 2.5 | 23.5 | 30 |
| ERA | 5S ✓ | 40 | 40.0 | M35x1.0 | 15.5 | 45.0 | 78.5 | - | 3.0 | 33.5 | - |

Note: the 5S series is delivered with a tapered washer and a round nut.
¹ unipole model
² high voltage

EHP Fixed socket, nut fixing, protruding shell



| Reference | | Dimensions (mm) | | | | | | | | | |
|-----------|--------|-----------------|------|---------|-----|------|------|----------------|------|-----|----|
| Model | Series | A | B | ø | E | L | L' | L ² | M | S1 | S3 |
| EHP | 0S ✓ | 10 | 12.5 | M9x0.6 | 2.5 | 17.5 | 18.5 | 25 | 12.5 | 8.2 | 11 |
| EHP | 1S ✓ | 14 | 16.0 | M12x1.0 | 3.5 | 20.2 | 21.5 | 32 | 12.0 | - | 14 |
| EHP | 3S ✓ | 22 | 25.2 | M18x1.0 | 4.0 | 29.0 | 30.0 | 52 | 18.7 | - | 22 |

Note: ¹ unipole model
² high voltage



Part number example see page 3



HOCHSPANNUNGFEST | HIGH VOLTAGE FIRM BAUFORM S-SERIE | MODEL S-SERIES

PCA Free socket, cable collet

| Reference | | Dimensions (mm) | | |
|-----------|--------|-----------------|------|------|
| Model | Series | A | L | S2 |
| PCA | 0S ✓ | 8.9 | 33.5 | 6.5 |
| PCA | 1S ✓ | 11.9 | 40.5 | 8.5 |
| PCA | 2S ✓ | 14.8 | 50.0 | 11.0 |
| PCA | 3S ✓ | 17.8 | 59.0 | 14.0 |
| PCA | 4S ✓ | 24.8 | 75.0 | 19.0 |
| PCA | 5S ✓ | 34.7 | 99.0 | 29.0 |



PCA Free socket with oversize cable collet

| Reference | | Dimensions (mm) | | | | |
|-----------|--------|-----------------|------|-------|------|------|
| Model | Series | A | B | L | S1 | S2 |
| PCA | 0S ✓ | 8.9 | 10,0 | 44.5 | 9.0 | 8.5 |
| PCA | 1S ✓ | 11.9 | 13.0 | 55.0 | 12.0 | 11.0 |
| PCA | 2S ✓ | 14.8 | 18.0 | 65.0 | 14.0 | 14.0 |
| PCA | 3S ✓ | 17.8 | 21.0 | 83.0 | 19.0 | 19.0 |
| PCA | 4S ✓ | 24.8 | 31.8 | 105.0 | 28.5 | 29.0 |



Note: the fitting of oversize collets onto this model allows it to be fitted to the cables that can be accommodated by the next housing size up.

PCA Free socket, cable collet and nut for fitting a bend relief

| Reference | | Dimensions (mm) | | |
|-----------|--------|-----------------|------|------|
| Model | Series | A | L | S2 |
| PCA | 0S ✓ | 8.9 | 33.5 | 7.0 |
| PCA | 1S ✓ | 11.9 | 40.5 | 9.0 |
| PCA | 2S ✓ | 14.8 | 50.0 | 12.0 |
| PCA | 3S ✓ | 17.8 | 59.0 | 14.0 |
| PCA | 4S ✓ | 24.8 | 75.0 | 20.0 |



Note: the bend relief must be ordered separately (see page 80)

PCP Free socket, cable collet and inner anti-rotating device

| Reference | | Dimensions (mm) | | |
|-----------|--------|-----------------|------|------|
| Model | Series | A | L | S2 |
| PCP | 0S ✓ | 8.9 | 33.5 | 6.5 |
| PCP | 1S ✓ | 11.9 | 40.5 | 8.5 |
| PCP | 2S ✓ | 14.8 | 50.0 | 11.0 |
| PCP | 3S ✓ | 17.8 | 59.0 | 14.0 |
| PCP | 4S ✓ | 24.8 | 75.0 | 19.0 |



HOCHSPANNUNGSFEST | HIGH VOLTAGE FIRM
BAUFORM S-SERIE | MODEL S-SERIES



PSA Fixed socket, nut fixing, cable collet



| Reference | | Dimensions (mm) | | | | | | | | |
|-----------|--------|-----------------|------|---------|------|------|-----|------|------|----|
| Model | Series | A | B | e | E | L | M | S1 | S2 | S3 |
| PSA | 0S ✓ | 10 | 12.5 | M9x0.6 | 7.0 | 33.5 | 1.2 | 8.2 | 6.5 | 11 |
| PSA | 1S ✓ | 14 | 16.0 | M12x1.0 | 7.5 | 40.5 | 1.5 | 10.5 | 8.5 | 14 |
| PSA | 2S ✓ | 18 | 19.5 | M15x1.0 | 8.5 | 50.0 | 1.8 | 13.5 | 11.0 | 17 |
| PSA | 3S ✓ | 22 | 25.2 | M18x1.0 | 11.5 | 59.0 | 2.0 | 16.5 | 14.0 | 22 |
| PSA | 4S ✓ | 28 | 32.0 | M25x1.0 | 12.0 | 75.0 | 2.5 | 27.5 | 19.0 | 30 |
| PSA | 5S ✓ | 40 | 40.0 | M35x1.0 | 15.5 | 99.0 | 3.0 | 33.5 | 29.0 | - |

Note: the 5S series is delivered with a tapered washer and a round nut.

PSP Fixed socket, nut fixing, cable collet and inner anti-rotating device



| Reference | | Dimensions (mm) | | | | | | | | |
|-----------|--------|-----------------|------|---------|------|------|-----|------|------|----|
| Model | Series | A | B | e | E | L | M | S1 | S2 | S3 |
| PSP | 0S ✓ | 10 | 12.5 | M9x0.6 | 7.0 | 33.5 | 1.2 | 8.2 | 6.5 | 11 |
| PSP | 1S ✓ | 14 | 16.0 | M12x1.0 | 7.5 | 40.5 | 1.5 | 10.5 | 8.5 | 14 |
| PSP | 2S ✓ | 18 | 19.5 | M15x1.0 | 8.5 | 50.0 | 1.8 | 13.5 | 11.0 | 17 |
| PSP | 3S ✓ | 22 | 25.2 | M18x1.0 | 11.5 | 59.0 | 2.0 | 16.5 | 14.0 | 22 |
| PSP | 4S ✓ | 28 | 32.0 | M25x1.0 | 12.0 | 75.0 | 2.5 | 23.5 | 19.0 | 30 |

RAD Fixed coupler, nut fixing



| Reference | | Dimensions (mm) | | | | | | | |
|-----------|--------|-----------------|------|---------|------|------|-----|------|----|
| Model | Series | A | B | e | E | L | M | S1 | S2 |
| RAD | 0S ✓ | 10 | 12.5 | M9x0.6 | 7.0 | 25.0 | 1.2 | 8.2 | 11 |
| RAD | 1S ✓ | 14 | 16.0 | M12x1.0 | 7.5 | 28.5 | 1.5 | 10.5 | 14 |
| RAD | 2S ✓ | 18 | 19.5 | M15x1.0 | 8.5 | 31.5 | 1.8 | 13.5 | 17 |
| RAD | 3S ✓ | 22 | 25.2 | M18x1.0 | 11.5 | 38.5 | 2.0 | 16.5 | 22 |
| RAD | 4S ✓ | 28 | 32.0 | M25x1.0 | 12.0 | 46.5 | 2.5 | - | 30 |
| RAD | 5S ✓ | 40 | 40.0 | M35x1.0 | 15.5 | 60.5 | 3.0 | - | - |

Note: the 5S series is delivered with a tapered washer and a round nut.

SWH Fixed coupler, nut fixing watertight or vacuumtight



| Reference | | Dimensions (mm) | | | | | | | |
|-----------|--------|-----------------|------|----------|----|----|-----|------|----|
| Model | Series | A | B | e | E | L | M | S1 | S3 |
| SWH | 0S ✓ | 14 | 13.8 | M10x0.75 | 17 | 34 | 2.0 | 9.0 | 12 |
| SWH | 1S ✓ | 17 | 16.0 | M12x1.00 | 28 | 39 | 2.5 | 10.5 | 14 |
| SWH | 2S ✓ | 20 | 21.8 | M16x1.00 | 25 | 44 | 4.0 | 15.0 | 19 |
| SWH | 3S ✓ | 25 | 27.0 | M20x1.00 | 30 | 53 | 4.0 | 18.5 | 24 |
| SWH | 4S ✓ | 34 | 32.0 | M25x1.00 | 50 | 65 | 4.0 | 23.5 | 30 |
| SWH | 5S ✓ | 45 | 40.0 | M35x1.00 | 58 | 80 | 5.0 | 33.5 | - |

Note: see page 26 for the available plug and contact configurations and in order to ensure correct contact alignment.
 The 5S series is delivered with a round nut.



Part number example see page 3



HOCHSPANNUNGSFEST | HIGH VOLTAGE FIRM BAUFORM E-SERIE | MODEL E-SERIES

FFA Straight plug, cable collet – watertight

| Reference | | Dimensions (mm) | | | |
|-----------|--------|-----------------|----|------|----|
| Model | Series | A | L | M | S2 |
| FFA | 0E ✓ | 11 | 34 | 23.0 | 8 |
| FFA | 1E ✓ | 13 | 42 | 28.0 | 9 |
| FFA | 2E ✓ | 16 | 52 | 36.0 | 12 |
| FFA | 3E ✓ | 19 | 61 | 41.0 | 15 |
| FFA | 4E ✓ | 25 | 71 | 50.5 | 19 |
| FFA | 5E ✓ | 38 | 92 | 67.0 | 32 |

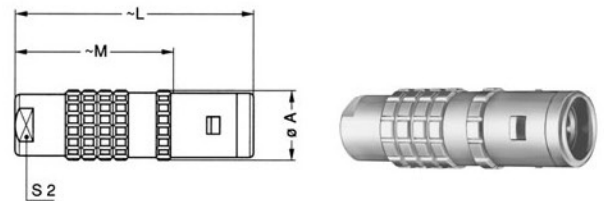

FFA Straight plug with oversize cable collet – watertight

| Reference | | Dimensions (mm) | | | | | |
|-----------|--------|-----------------|------|-----|----|----|----|
| Model | Series | A | B | L | M | S1 | S2 |
| FFA | 1E ✓ | 13 | 14.5 | 55 | 41 | 12 | 12 |
| FFA | 2E ✓ | 16 | 17.0 | 65 | 49 | 15 | 15 |
| FFA | 3E ✓ | 19 | 22.0 | 80 | 60 | 19 | 19 |
| FFA | 4E ✓ | 25 | 36.0 | 105 | 84 | 30 | 32 |

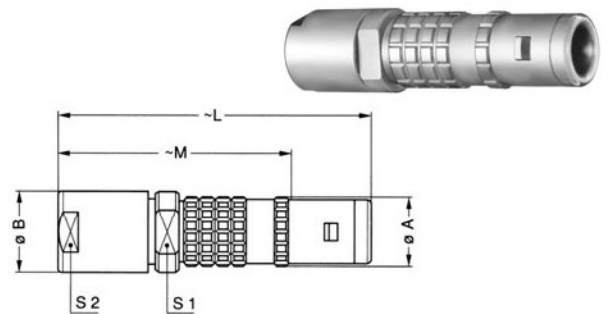

Note: the fitting of oversize collets onto this model allows them to be fitted to the cables that can be accommodated by the next housing size up

FFA Straight plug, cable collet and nut for fitting a bend relief – watertight

| Reference | | Dimensions (mm) | | | |
|-----------|--------|-----------------|----|------|----|
| Model | Series | A | L | M | S2 |
| FFA | 0E ✓ | 11 | 34 | 23.0 | 7 |
| FFA | 1E ✓ | 13 | 42 | 28.0 | 9 |
| FFA | 2E ✓ | 16 | 52 | 36.0 | 12 |
| FFA | 3E ✓ | 19 | 60 | 40.0 | 15 |
| FFA | 4E ✓ | 25 | 71 | 50.5 | 19 |

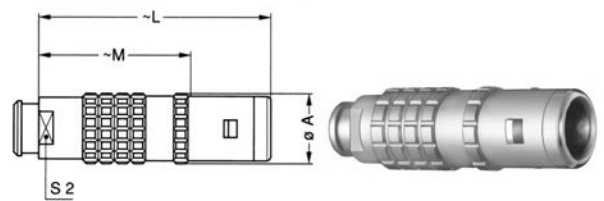

Note: the bend relief must be ordered separately (see page 80)

EBR Fixed socket with round flange, watertight, protruding shell and screw fixing

| Reference | | Dimensions (mm) | | | | | | | | | |
|-----------|--------|-----------------|----|-----|------|------|------|----------------|----------------|----|----|
| Model | Series | A | B | C | H1 | H2 | L | L ¹ | L ² | M | N |
| EBR | 2E ✓ | 28 | 19 | 2.8 | 11.8 | 20.4 | 32.5 | 28.0 | - | 19 | 15 |

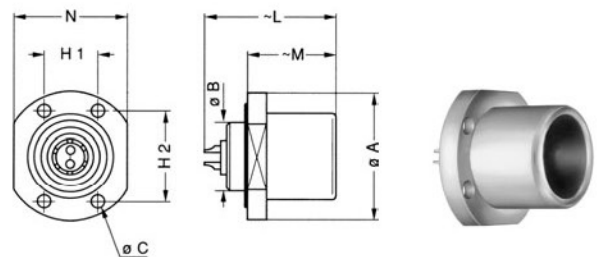

Note: this model is only available in a watertight version
¹ unipole model

2 high voltage on request

✓ Bei Lemo vorhanden | available at Lemo

HOCHSPANNUNGSFEST | HIGH VOLTAGE FIRM
BAUFORM E-SERIE | MODEL E-SERIES



ERA Fixed socket, nut fixing – watertight



| Reference | | Dimensions (mm) | | | | | | | | | |
|-----------|--------|-----------------|------|---------|------|------|------|----------------|-----|------|----|
| Model | Series | A | B | e | E | L | L' | L ² | M | S1 | S3 |
| ERA | 0E ✓ | 18 | 19.5 | M14x1.0 | 7.0 | 19.5 | 20.5 | 26 | 4.0 | 12.5 | 17 |
| ERA | 1E ✓ | 20 | 21.5 | M16x1.0 | 9.0 | 24.0 | 25.3 | 36 | 4.5 | 14.5 | 19 |
| ERA | 2E ✓ | 25 | 27.5 | M20x1.0 | 9.0 | 28.5 | 30.0 | 45,8 | 5.0 | 18.5 | 24 |
| ERA | 3E ✓ | 31 | 34.5 | M24x1.0 | 11.0 | 34.0 | 35.0 | 58 | 6.0 | 22.5 | 30 |
| ERA | 4E ✓ | 37 | 41.5 | M30x1.0 | 9.0 | 36.0 | 38.0 | 59,7 | 6.5 | 28.5 | 36 |
| ERA | 5E ✓ | 55 | 54.0 | M45x1.5 | 10.0 | 44.5 | 78.0 | | 9.0 | 42.5 | - |

Note: the 5E series is delivered with a tapered washer and a round nut
 1 unipole model
 2 high voltage

PCA Free socket, cable collet – watertight

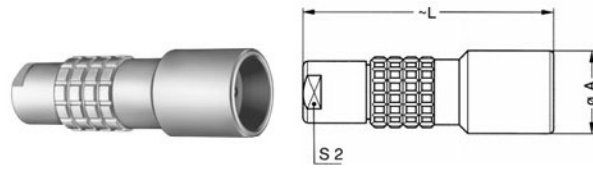

| Reference | | Dimensions (mm) | | |
|-----------|--------|-----------------|------|----|
| Model | Series | A | L | S2 |
| PCA | 0E | 13 | 34.0 | 8 |
| PCA | 1E ✓ | 15 | 45.0 | 9 |
| PCA | 2E ✓ | 19 | 54.0 | 12 |
| PCA | 3E ✓ | 23 | 65.0 | 15 |
| PCA | 4E ✓ | 29 | 75.5 | 19 |
| PCA | 5E | 42 | 95.0 | 32 |

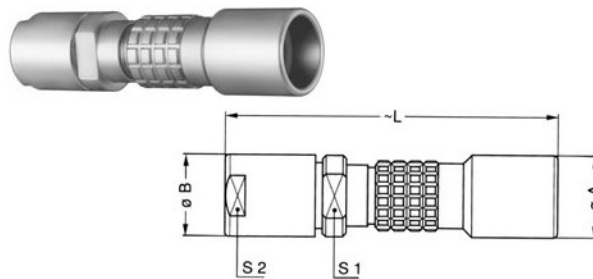

PCA Free socket with oversize cable collet – watertight

| Reference | | Dimensions (mm) | | | | |
|-----------|--------|-----------------|------|-----|----|----|
| Model | Series | A | B | L | S1 | S2 |
| PCA | 1E ✓ | 15 | 14.5 | 58 | 12 | 12 |
| PCA | 2E ✓ | 19 | 17.0 | 67 | 15 | 15 |
| PCA | 3E ✓ | 23 | 22.0 | 84 | 19 | 19 |
| PCA | 4E ✓ | 29 | 36.0 | 109 | 30 | 32 |

Note: the fitting of oversize collets onto this model allows them to be fitted to the cables that can be accommodated by the next housing size up

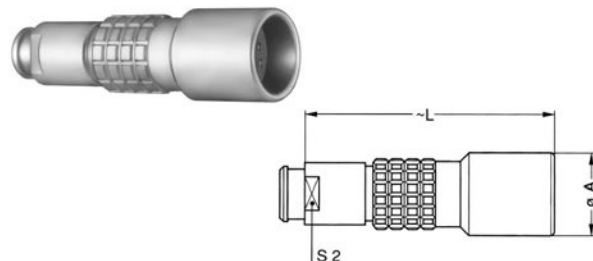

PCA Free socket, cable collet and nut for fitting a bend relief – watertight

| Reference | | Dimensions (mm) | | |
|-----------|--------|-----------------|------|----|
| Model | Series | A | L | S2 |
| PCA | 0E ✓ | 13 | 34.0 | 7 |
| PCA | 1E ✓ | 15 | 45.0 | 9 |
| PCA | 2E ✓ | 19 | 54.0 | 12 |
| PCA | 3E ✓ | 23 | 64.0 | 15 |
| PCA | 4E ✓ | 29 | 75.5 | 19 |

Note: the bend relief must be ordered separately (see page 80)



Part number example see page 3



HOCHSPANNUNGSFEST | HIGH VOLTAGE FIRM BAUFORM E-SERIE | MODEL E-SERIES

RMA Free coupler – watertight

| Reference | | Dimensions (mm) | |
|-----------|--------|-----------------|----|
| Model | Series | A | L |
| RMA | 0E ✓ | 14 | 30 |
| RMA | 1E ✓ | 16 | 40 |
| RMA | 2E ✓ | 20 | 44 |
| RMA | 3E | 25 | 54 |
| RMA | 4E ✓ | 30 | 57 |
| RMA | 5E | 44 | 67 |

Note: see page 26 for the available plug and contact configurations and in order to ensure correct contact alignment



SWH Fixed coupler, nut fixing, watertight and vacuumtight

| Reference | | Dimensions (mm) | | | | | | | |
|-----------|--------|-----------------|------|---------|----|------|-----|------|----|
| Model | Series | A | B | ø | E | L | M | S1 | S3 |
| SWH | 0E | 18 | 19.5 | M14x1.0 | 21 | 36.0 | 4.0 | 12.5 | 17 |
| SWH | 1E ✓ | 20 | 21.5 | M16x1.0 | 29 | 47.0 | 4.5 | 14.5 | 19 |
| SWH | 2E | 25 | 27.5 | M20x1.0 | 28 | 52.5 | 5.0 | 18.5 | 24 |
| SWH | 3E | 31 | 34.5 | M24x1.0 | 33 | 64.0 | 6.0 | 22.5 | 30 |
| SWH | 4E | 37 | 41.5 | M30x1.0 | 43 | 70.0 | 6.5 | 28.5 | 36 |
| SWH | 5E ✓ | 55 | 54.0 | M45x1.5 | 45 | 81.0 | 9.0 | 42.5 | - |

Note: The 5E series are delivered with a round nut. See page 26 for the available plug and contact configurations and in order to ensure correct contact alignment.

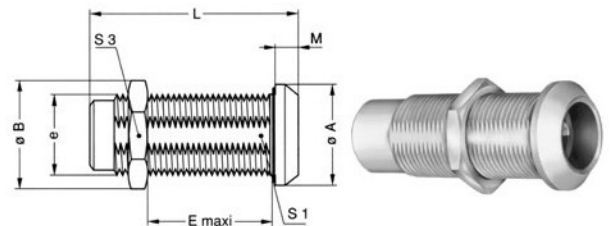

HGP Fixed socket, nut fixing, watertight and vacuumtight

| Reference | | Dimensions (mm) | | | | | | | | | |
|-----------|--------|-----------------|------|---------|------|------|------|------|-----|------|----|
| Model | Series | A | B | ø | E | L | L' | L² | M | S1 | S3 |
| HGP | 0E | 18 | 19.5 | M14x1.0 | 7.0 | 23.5 | 22.0 | 26,2 | 4.0 | 12.5 | 17 |
| HGP | 1E | 20 | 21.5 | M16x1.0 | 9.0 | 28.0 | 28.0 | 33,9 | 4.5 | 14.5 | 19 |
| HGP | 2E | 25 | 27.5 | M20x1.0 | 10.5 | 32.5 | 28.0 | 45,7 | 5.0 | 18.5 | 24 |
| HGP | 3E | 31 | 34.5 | M24x1.0 | 15.5 | 39.5 | 38.5 | 64,7 | 6.0 | 22.5 | 30 |
| HGP | 4E ✓ | 37 | 41.5 | M30x1.0 | 17.5 | 43.0 | 44.0 | | 6.5 | 28.5 | 36 |
| HGP | 5E ✓ | 55 | 54.0 | M45x1.5 | 20.0 | 52.0 | 76.0 | | 9.0 | 42.5 | - |

Note: the 5E series are delivered with a round nut
 1 unipole model
 2 high voltage



✓ Bei Lemo vorhanden | available at Lemo

HOCHSPANNUNGSFEST | HIGH VOLTAGE FIRM
KONTAKTFIGURATION SERIE S+E | CONTACTFIGURATION SERIES S+E

| Soldersided seen | | Order-No. | Size | Impedance | Contact- ϕ | Max. conductor- ϕ | Valid current | Supply voltage U_s (kV dc) | | Test voltage U_e (kV dc) | | Cable-order-no. | Type of insulation | Delivery time |
|------------------|----------------|-----------|------|-----------|-----------------|------------------------|---------------|------------------------------|-----|----------------------------|-----------|-----------------|--------------------|---------------|
| Male contact | Female contact | | | | | | | K-K | K-M | K-K | K-M | | | |
| | | 403 | 0 | - | 0.9 | 0.8 | 4 | - | 4 | - | 6 | RG-174A/U | high voltage | ● |
| | | 405 | 1 | - | 1.35 | 1.1 | 8 | - | 7 | - | 10.5 | 106 330 | high voltage | ● |
| | | 405X | 1 | - | 1.35 | 1.1 | 10 | - | 7 | - | 10.5 | 106 330 | high voltage | ● |
| | | 408 | 2 | - | 2 | 1.8 | 10 | - | 8 | - | 12.0 | 130 660 | high voltage | ● |
| | | 408X | 2 | - | 2 | 1.8 | 10 | - | 8 | - | 12.0 | 130 660 | high voltage | ● |
| | | 405 | 3 | - | 4 | 3.5 | 15 | - | 7 | - | 10.6 | 130 660 | high voltage | ● |
| | | 410 | 3 | - | 2 | 1.8 | 10 | - | 10 | - | 15.0 | 130 660 | high voltage | ● |
| | | 410X | 3 | - | 2 | 1.8 | 6 | - | 10 | - | 15.0 | 130 660 | high voltage | ● |
| | | 415 | 3 | - | 1.3 | 1.0 | 8 | - | 15 | - | 21.0 | 130 660 | high voltage | ● |
| | | 415X | 3 | - | 1.3 | 1.0 | 2 | - | 15 | - | 21.0 | 210 440 | high voltage | ● |
| | | 432 | 3 | - | 1.3 | 1.0 | 3 | 3 | 3 | 4.5 ¹ 8 | 4.5 8 | on request | high voltage | ● |
| | | 410 | 4 | - | 2.5 | 3.2 | 12 | - | 10 | - | 15 | on request | high voltage | ◐ |
| | | 433 | 4 | - | 2 | 1.8 | 14 | 2.1 | 3 | 3.1 ¹ 8 | 4.5 8 | on request | high voltage | ◐ |
| | | 434 | 4 | - | 2 | 1.8 | 14 | 2.1 | 3 | 3.1 ¹ 8 | 4.5 8 | on request | high voltage | ◐ |
| | | 442 | 4 | - | 1.3 | 1 | 14 | 3.5 | 5.0 | 5.2 ¹ 14 | 7.5 14 | on request | high voltage | ◐ |



Part number example see page 3



HOCHSPANNUNGSFEST | HIGH VOLTAGE FIRM
KONTAKTFIGURATION SERIE S+E | CONTACTFIGURATION SERIES S+E

| Soldersided seen | | Order-No. | Size |
|------------------|----------------|-----------|------|
| Male contact | Female contact | | |
| | | 442 | 5 |
| | | 438 | 5 |
| | | 443 | 5 |
| | | 444 | 5 |

| Impedance | Contact-ø | Max. conductor-ø | Valid current | Supply voltage U _s (kV dc) | | Test voltage U _e (kV dc) | | Cable-order-no. | Type of insulation | Delivery time |
|-----------|-----------|------------------|---------------|--|-----|--|------------|-----------------|--------------------|---------------|
| Ω | mm | mm | A | K-K | K-M | K-K | K-M | | | |
| - | 2 | 1.8 | 20 | 3.5 | 5.0 | 5.2 ¹ 14 | 7.5 14 | on request | high voltage | ○ |
| - | 2 | 1.8 | 18 | 2.1 | 3.0 | 3.1 ¹ 14 | 10.5 14 | on request | high voltage | ○ |
| - | 2 | 1.8 | 20 | 3.5 | 5.0 | 5.2 ¹ 14 | 7.5 14 | on request | high voltage | ○ |
| - | 2 | 1.8 | 18 | 3.5 | 5.0 | 5.2 ¹ 14 | 7.5 14 | on request | high voltage | ○ |

Note: ¹ Test nach CEI 130.1 § 14.5b U_s = $\frac{U_e}{1.5}$

HOCHSPANNUNGSFEST | HIGH VOLTAGE FIRM
KONFEKTIONIERUNGSANLEITUNG | ASSEMBLING INSTRUCTIONS



| Reference | | | Contact ø (mm) | Unisolated length (mm) | | |
|-----------|------|-------|-------------------|------------------------|------|------|
| Series | Type | Cable | | A | B | C |
| 0S/0E | 403 | HS | 0.9 | 4.0 | 6.0 | 9.0 |
| 0S/0E | 403X | HS | 0.9 | 4.0 | 6.0 | 9.0 |
| 1S/1E | 405 | HS | 1.35 | 5.0 | 10.5 | 14.0 |
| 1S/1E | 405X | HS | 1.35 | 5.0 | 10.5 | 14.0 |
| 2S/2E | 408 | HS | 2.0 | 7.0 | 14.0 | 18.0 |
| 2S/2E | 408X | HS | 2.0 | 7.0 | 14.0 | 18.0 |
| 3S/3E | 405 | HS | 4.0 | 6.5 | 12.0 | 17.0 |
| 3S/3E | 405X | HS | 4.0 | 6.5 | 12.0 | 17.0 |
| 3S/3E | 410 | HS | 2.0 | 7.5 | 19.0 | 24.0 |
| 3S/3E | 410X | HS | 2.0 | 7.5 | 19.0 | 24.0 |
| 3S/3E | 415 | HS | 1.3 | 6.5 | 27.0 | 32.0 |
| 3S/3E | 415X | HS | 1.3 | 6.5 | 27.0 | 32.0 |
| 4S/4E | 410 | HS | 2.5 | 10.0 | 20.0 | 26.0 |
| 4S/4E | 410X | HS | 2.5 | 10.0 | 20.0 | 26.0 |



Note: The dimensions are standard values and may vary depending on the cable quality.

Die Abmessungen sind Richtwerte und können sich je nach Kabelqualität ändern.

Technische Informationen, Zubehörteile und Werkzeuge siehe Unipole/Multipole Katalog.
 Technical Informations, Accessories and Tools see Unipole/Multipole Catalogue.

The background features a technical drawing of a high-current connector assembly in white lines on a blue background. A large, stylized lightning bolt graphic is positioned on the right side, extending from the top towards the bottom. The drawing shows various components like a grid, a cylindrical part, and a multi-pin connector.

Steckverbindungen
Connectors
Kontaktfiguration
Contactfiguration
Konfektionierungsanleitung
Assembling Instructions



EINPOLIG HOCHSTROM
UNIPOLE HIGH CURRENT

EINPOLIG / HOCHSTROM | UNIPOLE / HIGH CURRENT
BAUFORM S-SERIE | MODEL S-SERIES



FFA Straight plug, cable collet



| Reference | | Dimensions (mm) | | | |
|-----------|--------|-----------------|-------|------|------|
| Model | Series | A | L | M | S2 |
| FFA | 00 ✓ | 6.4 | 26.0 | 18.0 | 4.5 |
| FFA | 0S ✓ | 9.0 | 34.5 | 24.5 | 6.5 |
| FFA | 1S ✓ | 12.0 | 42.5 | 31.5 | 8.5 |
| FFA | 2S ✓ | 14.8 | 52.0 | 40.0 | 11.0 |
| FFA | 3S ✓ | 17.8 | 61.0 | 46.0 | 14.0 |
| FFA | 4S ✓ | 24.8 | 77.0 | 59.0 | 19.0 |
| FFA | 5S ✓ | 35.1 | 103.0 | 78.0 | 29.0 |

FFA Straight plug with oversize cable collet

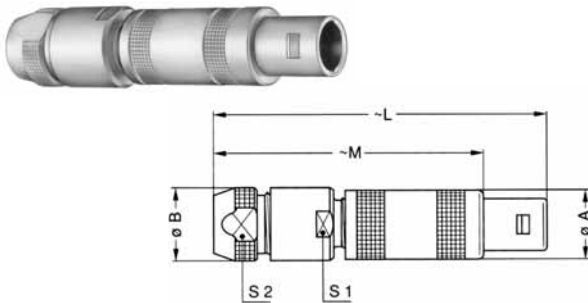

| Reference | | Dimensions (mm) | | | | | |
|-----------|--------|-----------------|------|-------|-------|------|------|
| Model | Series | A | B | L | M | S1 | S2 |
| FFA | 00 ✓ | 6.4 | 8.0 | 34.0 | 26.0 | 7.0 | 6.5 |
| FFA | 0S ✓ | 9.0 | 10.0 | 45.5 | 35.5 | 9.0 | 8.5 |
| FFA | 1S ✓ | 12.0 | 13.0 | 57.0 | 46.0 | 12.0 | 11.0 |
| FFA | 2S ✓ | 14.8 | 18.0 | 67.0 | 55.0 | 14.0 | 14.0 |
| FFA | 3S ✓ | 17.8 | 21.0 | 85.0 | 70.0 | 19.0 | 19.0 |
| FFA | 4S ✓ | 24.8 | 31.8 | 107.0 | 89.0 | 28.5 | 29.0 |
| FFA | 5S ✓ | 35.1 | 41.8 | 138.0 | 113.0 | 37.5 | 38.0 |

Note: the fitting of oversize collets onto this model allows them to be fitted to the cables that can be accommodated by the next housing size up

FFA Straight plug, cable collet
and nut for fitting a bend relief



| Reference | | Dimensions (mm) | | | |
|-----------|--------|-----------------|------|------|----|
| Model | Series | A | L | M | S2 |
| FFA | 00 ✓ | 6.4 | 26.0 | 18.0 | 6 |
| FFA | 0S ✓ | 9.0 | 34.5 | 24.5 | 7 |
| FFA | 1S ✓ | 12.0 | 42.5 | 31.5 | 9 |
| FFA | 2S ✓ | 14.8 | 52.0 | 40.0 | 12 |
| FFA | 3S ✓ | 17.8 | 61.0 | 46.0 | 14 |
| FFA | 4S ✓ | 24.8 | 77.0 | 59.0 | 20 |

Note: the bend relief must be ordered separately (see page 80)



Part number example see page 3



EINPOLIG / HOCHSTROM | UNIPOLE / HIGH CURRENT
BAUFORM S-SERIE | MODEL S-SERIES

FFP Straight plug, cable collet and inner anti-rotating device

| Reference | | Dimensions (mm) | | | |
|-----------|--------|-----------------|------|------|------|
| Model | Series | A | L | M | S2 |
| FFP | 0S | 9.0 | 34.5 | 24.5 | 6.5 |
| FFP | 1S | 12.0 | 42.5 | 31.5 | 8.5 |
| FFP | 2S | 14.8 | 52.0 | 40.0 | 11.0 |
| FFP | 3S ✓ | 17.8 | 61.0 | 46.0 | 14.0 |
| FFP | 4S | 24.8 | 77.0 | 59.0 | 19.0 |



FFB Straight plug, cable collet and safety locking ring

| Reference | | Dimensions (mm) | | | |
|-----------|--------|-----------------|------|------|------|
| Model | Series | A | L | M | S2 |
| FFB | 0S | 9.0 | 36.8 | 26.8 | 6.5 |
| FFB | 1S ✓ | 12.0 | 45.0 | 34.0 | 8.5 |
| FFB | 2S | 14.8 | 55.5 | 43.5 | 11.0 |
| FFB | 3S ✓ | 17.8 | 65.0 | 50.0 | 14.0 |



FFB Straight plug, cable collet and safety locking ring and nut for fitting a bend relief

| Reference | | Dimensions (mm) | | | |
|-----------|--------|-----------------|------|------|----|
| Model | Series | A | L | M | S2 |
| FFB | 0S | 9.0 | 36.8 | 26.8 | 7 |
| FFB | 1S ✓ | 12.0 | 45.0 | 34.0 | 9 |
| FFB | 2S | 14.8 | 55.5 | 43.5 | 12 |
| FFB | 3S | 17.8 | 65.0 | 50.0 | 14 |

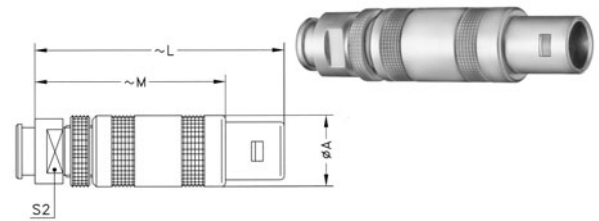

Note: series 0S, 2S and 3S are available on request
the bend relief must be ordered separately (see page 80)

FFF Straight plug, non-latching, cable collet

| Reference | | Dimensions (mm) | | | |
|-----------|--------|-----------------|------|------|------|
| Model | Series | A | L | M | S2 |
| FFF | 00 ✓ | 6.4 | 26.0 | 18.0 | 4.5 |
| FFF | 0S ✓ | 9.0 | 34.5 | 24.5 | 6.5 |
| FFF | 1S | 12.0 | 42.5 | 31.5 | 8.5 |
| FFF | 2S | 14.8 | 52.0 | 40.0 | 11.0 |

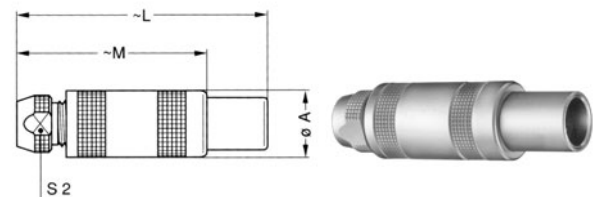

EINPOLIG / HOCHSTROM | UNIPOLE / HIGH CURRENT
BAUFORM S-SERIE | MODEL S-SERIES

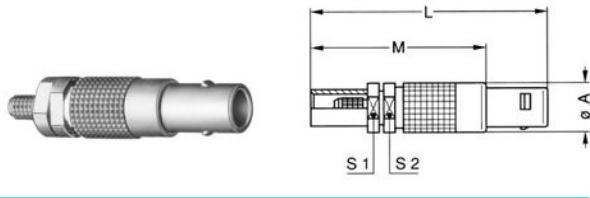

FFS Straight plug for cable crimping

| Reference | | Dimensions (mm) | | | | |
|-----------|--------|-----------------|----|----|-----|-----|
| Model | Series | A | L | M | S1 | S2 |
| FFS | 00 ✓ | 6.4 | 31 | 23 | 5.5 | 5.5 |

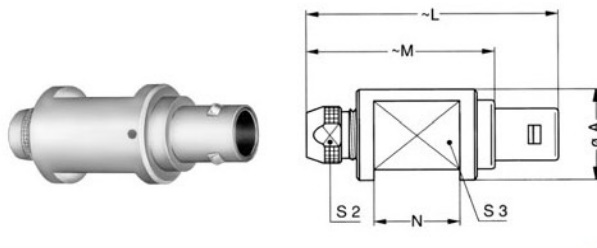

FZP Straight plug for remote handling, cable collet and inner anti-rotating device

| Reference | | Dimensions (mm) | | | | | |
|-----------|--------|-----------------|-------|------|----|------|----|
| Model | Series | A | L | M | N | S2 | S3 |
| FZP | 1S | 16 | 42.5 | 31.5 | 15 | 8.5 | 12 |
| FZP | 2S | 24 | 52.0 | 40.0 | 21 | 11.0 | 18 |
| FZP | 3S | 24 | 61.0 | 46.0 | 24 | 14.0 | 18 |
| FZP | 4S | 35 | 77.0 | 59.0 | 30 | 19.0 | 28 |
| FZP | 5S ✓ | 43 | 103.0 | 78.0 | 44 | 29.0 | 35 |

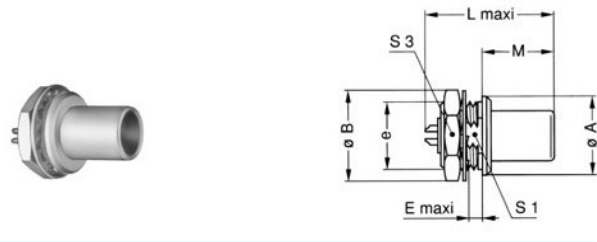

FAA Fixed plug non-latching, nut fixing

| Reference | | Dimensions (mm) | | | | | | | |
|-----------|--------|-----------------|------|---------|-----|------|------|------|----|
| Model | Series | A | B | e | E | L' | M | S1 | S3 |
| FAA | 00 ✓ | 8 | 10.3 | M7x0.5 | 2.0 | 15.5 | 9.0 | 6.3 | 9 |
| FAA | 0S ✓ | 10 | 12.5 | M9x0.6 | 2.0 | 18.0 | 11.2 | 8.2 | 11 |
| FAA | 1S ✓ | 14 | 16.0 | M12x1.0 | 2.5 | 21.7 | 12.5 | 10.5 | 14 |
| FAA | 2S ✓ | 18 | 19.5 | M15x1.0 | 4.0 | 25.3 | 13.8 | 13.5 | 17 |
| FAA | 3S ✓ | 22 | 25.2 | M18x1.0 | 4.0 | 29.0 | 17.0 | 16.5 | 22 |
| FAA | 4S ✓ | 28 | 32.0 | M25x1.0 | 2.5 | 39.0 | 20.5 | 23.5 | 30 |
| FAA | 5S | 40 | 40.0 | M35x1.0 | 2.5 | - | 28.0 | 33.5 | - |

Note: ¹ unipole model

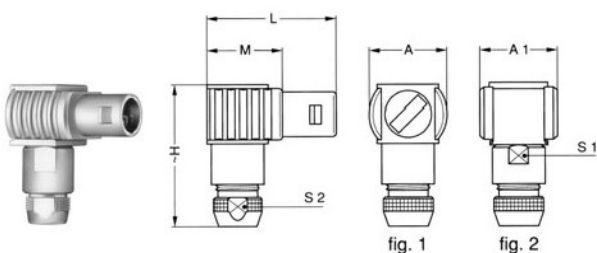

FLA Elbow (90°) plug, cable collet

| Reference | | Dimensions (mm) | | | | | | |
|-----------|--------|-----------------|----|------|------|------|----|------|
| Model | Series | A | A1 | H | L | M | S1 | S2 |
| FLA | 00 ✓ | 9 | - | 16.0 | 17.5 | 9.5 | - | 4.5 |
| FLA | 0S ✓ | 13 | 13 | 24.5 | 23.0 | 13.0 | 8 | 6.5 |
| FLA | 1S ✓ | 16 | 16 | 28.5 | 26.5 | 15.5 | 10 | 8.5 |
| FLA | 2S ✓ | 20 | 20 | 37.0 | 31.0 | 19.0 | 13 | 11.0 |
| FLA | 3S ✓ | 21 | 21 | 44.0 | 38.5 | 23.5 | 15 | 14.0 |
| FLA | 4S ✓ | 28 | 28 | 56.0 | 49.0 | 31.0 | 20 | 19.0 |
| FLA | 5S | - | 37 | 76.5 | 65.0 | 40.0 | 30 | 29.0 |

Note: fig.1 is used for the unipole type, fig.2 is used for the multipole type

EINPOLIG / HOCHSTROM | UNIPOLE / HIGH CURRENT
 BAUFORM S-SERIE | MODEL S-SERIES

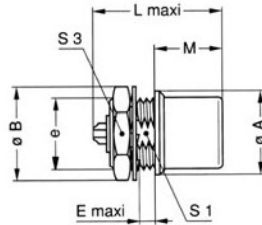

EHP Fixed socket, nut fixing, protruding shell

| Reference | | Dimensions (mm) | | | | | | | |
|-----------|--------|-----------------|------|---------|-----|------|------|-----|----|
| Model | Series | A | B | e | E | L' | M | S1 | S3 |
| EHP | 0S ✓ | 10 | 12.5 | M9x0.6 | 2.5 | 18.5 | 12.5 | 8.2 | 11 |
| EHP | 1S | 14 | 16.0 | M12x1.0 | 3.5 | 21.5 | 12.0 | - | 14 |
| EHP | 3S ✓ | 22 | 25.2 | M18x1.0 | 4.0 | 30.0 | 18.7 | - | 22 |

Note: ¹unipole model

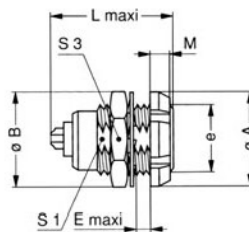

ERD Fixed socket with two nuts
 (back panel mounting)

| Reference | | Dimensions (mm) | | | | | | | |
|-----------|--------|-----------------|------|---------|------|------|-----|------|----|
| Model | Series | A | B | e | E | L' | M | S1 | S3 |
| ERD | 0S ✓ | 12 | 12.5 | M9x0.6 | 5.5 | 18.5 | 2.5 | 8.2 | 11 |
| ERD | 1S ✓ | 16 | 16.0 | M12x1.0 | 6.0 | 21.5 | 3.5 | 10.5 | 14 |
| ERD | 2S ✓ | 20 | 19.5 | M15x1.0 | 6.5 | 26.0 | 3.5 | 13.5 | 17 |
| ERD | 3S | 24 | 25.2 | M18x1.0 | 9.0 | 30.0 | 4.5 | 16.5 | 22 |
| ERD | 4S | 30 | 32.0 | M25x1.0 | 10.0 | 36.0 | 4.5 | 23.5 | 30 |

Note: the 3S and 4S series are delivered with a conical nut
¹unipole model

RMA Free coupler

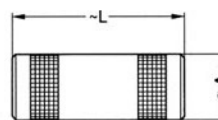

| Reference | | Dimensions (mm) | |
|-----------|--------|-----------------|------|
| Model | Series | A | L |
| RMA | 00 ✓ | 6.4 | 22.0 |
| RMA | 0S ✓ | 8.9 | 25.0 |
| RMA | 1S | 11.9 | 28.5 |
| RMA | 2S | 14.8 | 31.5 |
| RMA | 3S ✓ | 17.8 | 38.5 |
| RMA | 4S ✓ | 24.8 | 46.5 |
| RMA | 5S | 34.7 | 60.5 |

Note: see page 40 for the available plug and contact configurations and in order to ensure correct contact alignment



Part number example see page 3



EINPOLIG / HOCHSTROM | UNIPOLE / HIGH CURRENT
BAUFORM S-SERIE | MODEL S-SERIES

RAD Fixed coupler, nut fixing

| Reference | | Dimensions (mm) | | | | | | | |
|-----------|--------|-----------------|------|---------|------|------|-----|------|----|
| Model | Series | A | B | e | E | L | M | S1 | S2 |
| RAD | 00 ✓ | 8 | 10.3 | M7x0.5 | 5.5 | 22.0 | 1.0 | 6.3 | 9 |
| RAD | 0S | 10 | 12.5 | M9x0.6 | 7.0 | 25.0 | 1.2 | 8.2 | 11 |
| RAD | 1S | 14 | 16.0 | M12x1.0 | 7.5 | 28.5 | 1.5 | 10.5 | 14 |
| RAD | 2S | 18 | 19.5 | M15x1.0 | 8.5 | 31.5 | 1.8 | 13.5 | 17 |
| RAD | 3S | 22 | 25.2 | M18x1.0 | 11.5 | 38.5 | 2.0 | 16.5 | 22 |
| RAD | 4S ✓ | 28 | 32.0 | M25x1.0 | 12.0 | 46.5 | 2.5 | - | 30 |
| RAD | 5S | 40 | 40.0 | M35x1.0 | 15.5 | 60.5 | 3.0 | - | - |

Note: the 5S series is delivered with a tapered washer and a round nut see page 40 for the available plug and contact configurations and in order to ensure correct contact alignment



SWH Fixed coupler, nut fixing watertight or vacuumtight

| Reference | | Dimensions (mm) | | | | | | | |
|-----------|--------|-----------------|------|----------|----|----|-----|------|----|
| Model | Series | A | B | e | E | L | M | S1 | S3 |
| SWH | 0S ✓ | 14 | 13.8 | M10x0.75 | 17 | 34 | 2.0 | 9.0 | 12 |
| SWH | 1S ✓ | 17 | 16.0 | M12x1.00 | 28 | 39 | 2.5 | 10.5 | 14 |
| SWH | 2S ✓ | 20 | 21.8 | M16x1.00 | 25 | 44 | 4.0 | 15.0 | 19 |
| SWH | 3S ✓ | 25 | 27.0 | M20x1.00 | 30 | 53 | 4.0 | 18.5 | 24 |
| SWH | 4S ✓ | 34 | 32.0 | M25x1.00 | 50 | 65 | 4.0 | 23.5 | 30 |
| SWH | 5S ✓ | 45 | 40.0 | M35x1.00 | 58 | 80 | 5.0 | 33.5 | - |

Note: see page 40 for the available plug and contact configurations and in order to ensure correct contact alignment. The 5S series is delivered with a round nut.



PCA Free socket, cable collet

| Reference | | Dimensions (mm) | | |
|-----------|--------|-----------------|------|------|
| Model | Series | A | L | S2 |
| PCA | 00 ✓ | 6.5 | 25.0 | 4.5 |
| PCA | 0S ✓ | 8.9 | 33.5 | 6.5 |
| PCA | 1S ✓ | 11.9 | 40.5 | 8.5 |
| PCA | 2S | 14.8 | 50.0 | 11.0 |
| PCA | 3S ✓ | 17.8 | 59.0 | 14.0 |
| PCA | 4S ✓ | 24.8 | 75.0 | 19.0 |
| PCA | 5S | 34.7 | 99.0 | 29.0 |

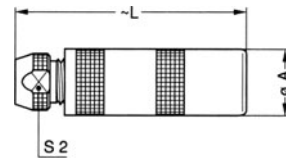

PCA Free socket with oversize cable collet

| Reference | | Dimensions (mm) | | | | |
|-----------|--------|-----------------|------|-------|------|------|
| Model | Series | A | B | L | S1 | S2 |
| PCA | 00 ✓ | 6.5 | 8.0 | 33.0 | 7.0 | 6.5 |
| PCA | 0S ✓ | 8.9 | 10.0 | 44.5 | 9.0 | 8.5 |
| PCA | 1S ✓ | 11.9 | 13.0 | 55.0 | 12.0 | 11.0 |
| PCA | 2S ✓ | 14.8 | 18.0 | 65.0 | 14.0 | 14.0 |
| PCA | 3S ✓ | 17.8 | 21.0 | 83.0 | 19.0 | 19.0 |
| PCA | 4S ✓ | 24.8 | 31.8 | 105.0 | 28.5 | 29.0 |

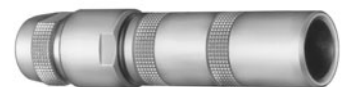

Note: the fitting of oversize collets onto this model allows them to be fitted to the cables that can be accommodated by the next housing size up

✓ Bei Lemo vorhanden | available at Lemo

EINPOLIG / HOCHSTROM | UNIPOLE / HIGH CURRENT
BAUFORM S-SERIE | MODEL S-SERIES



PCA Free socket, cable collet and nut for fitting a bend relief

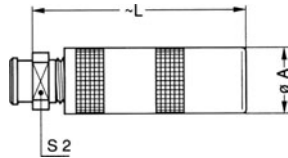

| Reference | | Dimensions (mm) | | |
|-----------|--------|-----------------|------|----|
| Model | Series | A | L | S2 |
| PCA | 00 ✓ | 6.5 | 25.0 | 6 |
| PCA | 0S ✓ | 8.9 | 33.5 | 7 |
| PCA | 1S ✓ | 11.9 | 40.5 | 9 |
| PCA | 2S ✓ | 14.8 | 50.0 | 12 |
| PCA | 3S ✓ | 17.8 | 59.0 | 14 |
| PCA | 4S ✓ | 24.8 | 75.0 | 20 |

Note: the bend relief must be ordered separately (see page 80)

PSA Fixed socket, nut fixing, cable collet

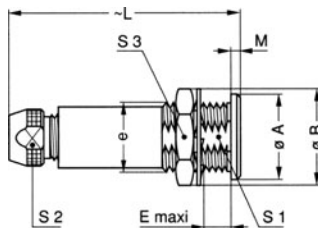

| Reference | | Dimensions (mm) | | | | | | | | |
|-----------|--------|-----------------|------|---------|------|------|-----|------|------|----|
| Model | Series | A | B | e | E | L | M | S1 | S2 | S3 |
| PSA | 00 ✓ | 8 | 10.3 | M7x0.5 | 5.5 | 25.0 | 1.0 | 6.3 | 4.5 | 9 |
| PSA | 0S ✓ | 10 | 12.5 | M9x0.6 | 7.0 | 33.5 | 1.2 | 8.2 | 6.5 | 11 |
| PSA | 1S ✓ | 14 | 16.0 | M12x1.0 | 7.5 | 40.5 | 1.5 | 10.5 | 8.5 | 14 |
| PSA | 2S ✓ | 18 | 19.5 | M15x1.0 | 8.5 | 50.0 | 1.8 | 13.5 | 11.0 | 17 |
| PSA | 3S ✓ | 22 | 25.2 | M18x1.0 | 11.5 | 59.0 | 2.0 | 16.5 | 14.0 | 22 |
| PSA | 4S ✓ | 28 | 32.0 | M25x1.0 | 12.0 | 75.0 | 2.5 | 23.5 | 19.0 | 30 |
| PSA | 5S ✓ | 40 | 40.0 | M35x1.0 | 15.5 | 99.0 | 3.0 | 33.5 | 29.0 | - |

Note: the 5S series is delivered with a tapered washer and a round nut.

BAUFORM E-SERIE | MODEL E-SERIES

FFA Straight plug, cable collet – watertight

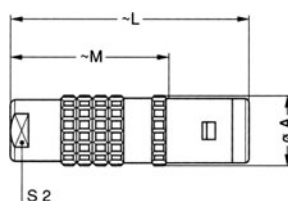

| Reference | | Dimensions (mm) | | | |
|-----------|--------|-----------------|----|------|----|
| Model | Series | A | L | M | S2 |
| FFA | 0E ✓ | 11 | 34 | 23.0 | 8 |
| FFA | 1E ✓ | 13 | 42 | 28.0 | 9 |
| FFA | 2E ✓ | 16 | 52 | 36.0 | 12 |
| FFA | 3E ✓ | 19 | 61 | 41.0 | 15 |
| FFA | 4E ✓ | 25 | 71 | 50.5 | 19 |
| FFA | 5E ✓ | 38 | 92 | 67.0 | 32 |



Part number example see page 3



EINPOLIG / HOCHSTROM | UNIPOLE / HIGH CURRENT

BAUFORM E-SERIE | MODEL E-SERIES

FFA Straight plug with oversize cable collet – watertight

| Reference | | Dimensions (mm) | | | | | |
|-----------|--------|-----------------|------|-----|----|----|----|
| Model | Series | A | B | L | M | S1 | S2 |
| FFA | 1E ✓ | 13 | 14.5 | 55 | 41 | 12 | 12 |
| FFA | 2E ✓ | 16 | 17.0 | 65 | 49 | 15 | 15 |
| FFA | 3E ✓ | 19 | 22.0 | 80 | 60 | 19 | 19 |
| FFA | 4E ✓ | 25 | 36.0 | 105 | 84 | 30 | 32 |

Note: the fitting of oversize collets onto this model allows them to be fitted to the cables that can be accommodated by the next housing size up



FFA Straight plug, cable collet and nut for fitting a bend relief – watertight

| Reference | | Dimensions (mm) | | | |
|-----------|--------|-----------------|----|------|----|
| Model | Series | A | L | M | S2 |
| FFA | 0E ✓ | 11 | 34 | 23.0 | 7 |
| FFA | 1E ✓ | 13 | 42 | 28.0 | 9 |
| FFA | 2E ✓ | 16 | 52 | 36.0 | 12 |
| FFA | 3E ✓ | 19 | 60 | 40.0 | 15 |
| FFA | 4E ✓ | 25 | 71 | 50.5 | 19 |

Note: the bend relief must be ordered separately (see page 80)



FFF Straight plug non-latching, cable collet – watertight

| Reference | | Dimensions (mm) | | | |
|-----------|--------|-----------------|----|----|----|
| Model | Series | A | L | M | S2 |
| FFF | 0E | 11 | 34 | 23 | 8 |
| FFF | 1E ✓ | 13 | 42 | 28 | 9 |



FLA Elbow (90°) plug, cable collet – watertight

| Reference | | Dimensions (mm) | | | | | | | |
|-----------|--------|-----------------|------|----|----|------|----|----|----|
| Model | Series | A | D | H | L | M | S1 | S2 | S3 |
| FLA | 0E | 11.5 | 7.6 | 27 | 36 | 25.0 | 10 | 8 | 8 |
| FLA | 1E | 14.0 | 8.8 | 33 | 43 | 29.0 | 12 | 9 | 10 |
| FLA | 2E | 17.5 | 10.5 | 40 | 51 | 35.0 | 15 | 12 | 13 |
| FLA | 3E ✓ | 21.0 | 11.5 | 47 | 60 | 40.0 | 18 | 15 | 15 |
| FLA | 4E | 27.5 | 15.5 | 57 | 72 | 51.5 | 24 | 19 | 20 |



EINPOLIG / HOCHSTROM | UNIPOLE / HIGH CURRENT
BAUFORM E-SERIE | MODEL E-SERIES

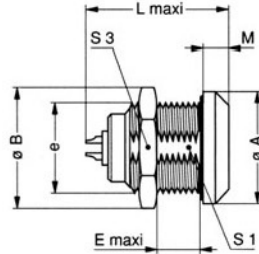

ERA Fixed socket, nut fixing – watertight

| Reference | | Dimensions (mm) | | | | | | | |
|-----------|--------|-----------------|------|---------|----|------|-----|------|----|
| Model | Series | A | B | e | E | L' | M | S1 | S3 |
| ERA | 0E ✓ | 18 | 19.5 | M14x1.0 | 7 | 20.5 | 4.0 | 12.5 | 17 |
| ERA | 1E ✓ | 20 | 21.5 | M16x1.0 | 9 | 25.3 | 4.5 | 14.5 | 19 |
| ERA | 2E ✓ | 25 | 27.5 | M20x1.0 | 9 | 30.0 | 5.0 | 18.5 | 24 |
| ERA | 3E ✓ | 31 | 34.5 | M24x1.0 | 11 | 35.0 | 6.0 | 22.5 | 30 |
| ERA | 4E ✓ | 37 | 41.5 | M30x1.0 | 9 | 38.0 | 6.5 | 28.5 | 36 |
| ERA | 5E ✓ | 55 | 54.0 | M45x1.5 | 10 | 78.0 | 9.0 | 42.5 | - |

Note: the 5E series is delivered with a round nut
1 unipole model

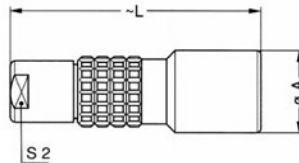
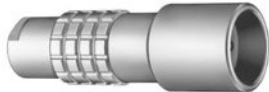

PCA Free socket, cable collet – watertight

| Reference | | Dimensions (mm) | | |
|-----------|--------|-----------------|------|----|
| Model | Series | A | L | S2 |
| PCA | 0E ✓ | 13 | 34.0 | 8 |
| PCA | 1E ✓ | 15 | 45.0 | 9 |
| PCA | 2E ✓ | 19 | 54.0 | 12 |
| PCA | 3E ✓ | 23 | 65.0 | 15 |
| PCA | 4E | 29 | 75.5 | 19 |
| PCA | 5E | 42 | 95.0 | 32 |

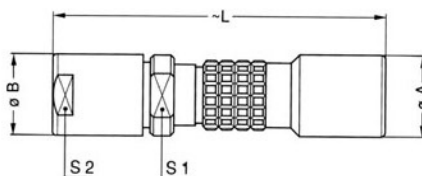

PCA Free socket with oversize cable collet – watertight

| Reference | | Dimensions (mm) | | | | |
|-----------|--------|-----------------|------|-----|----|----|
| Model | Series | A | B | L | S1 | S2 |
| PCA | 1E ✓ | 15 | 14.5 | 58 | 12 | 12 |
| PCA | 2E ✓ | 19 | 17.0 | 67 | 15 | 15 |
| PCA | 3E ✓ | 23 | 22.0 | 84 | 19 | 19 |
| PCA | 4E ✓ | 29 | 36.0 | 109 | 30 | 32 |

Note: the fitting of oversize collets onto this model allows them to be fitted to the cables that can be accommodated by the next housing size up



Part number example see page 3



EINPOLIG / HOCHSTROM | UNIPOLE / HIGH CURRENT
BAUFORM E-SERIE | MODEL E-SERIES

PCA Free socket, cable collet and nut for fitting a bend relief – watertight

| Reference | | Dimensions (mm) | | |
|-----------|--------|-----------------|------|----|
| Model | Series | A | L | S2 |
| PCA | 0E ✓ | 13 | 34.0 | 7 |
| PCA | 1E ✓ | 15 | 45.0 | 9 |
| PCA | 2E ✓ | 19 | 54.0 | 12 |
| PCA | 3E ✓ | 23 | 64.0 | 15 |
| PCA | 4E ✓ | 29 | 75.5 | 19 |

Note: the bend relief must be ordered separately (see page 80)



HGP Fixed socket, nut fixing, watertight and vacuumtight

| Reference | | Dimensions (mm) | | | | | | | |
|-----------|--------|-----------------|------|---------|------|------|-----|------|----|
| Model | Series | A | B | ø | E | L' | M | S1 | S3 |
| HGP | 0E ✓ | 18 | 19.5 | M14x1.0 | 7.0 | 22.0 | 4.0 | 12.5 | 17 |
| HGP | 1E ✓ | 20 | 21.5 | M16x1.0 | 9.0 | 28.0 | 4.5 | 14.5 | 19 |
| HGP | 2E | 25 | 27.5 | M20x1.0 | 10.5 | 28.0 | 5.0 | 18.5 | 24 |
| HGP | 3E | 31 | 34.5 | M24x1.0 | 15.5 | 38.5 | 6.0 | 22.5 | 30 |
| HGP | 4E | 37 | 41.5 | M30x1.0 | 17.5 | 44.0 | 6.5 | 28.5 | 36 |
| HGP | 5E | 55 | 54.0 | M45x1.5 | 20.0 | 76.0 | 9.0 | 42.5 | - |

Note: the 5E series is delivered with a round nut
 'unipole model

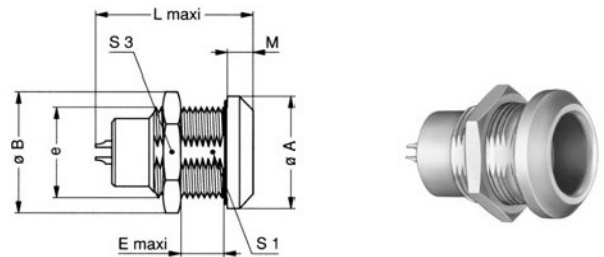

EINPOLIG / HOCHSTROM | UNIPOLE / HIGH CURRENT
KONTAKTFIGURATION SERIE E+S | CONTACTFIGURATION SERIES E+S

| Soldersided seen | | Order-No. | Size | Impedance | Contact- ϕ (ϕA) | Max. conductor- ϕ | Valid current | Supply voltage U_s (kV dc) | | Test voltage U_e (kV dc) | | Cable-order-no. | Type of insulation | Delivery time |
|------------------|----------------|-----------|------|-----------|------------------------------|------------------------|---------------|------------------------------|-----|----------------------------|-----|-----------------|--------------------|---------------|
| Male contact | Female contact | | | | | | | K-K | K-M | K-K | K-M | | | |
| | | 113 | 00 | - | 1.3 | 1.0 | 8 | 0.25 | 0.4 | 0.8 | 1.2 | RG-174/U | unipole | ● |
| | | 116 | 0 | - | 1.6 | 1.4 | 12 | - | 0.7 | - | 2.1 | RG-174/U | unipole | ● |
| | | 120 | 1 | - | 2 | 1.8 | 18 | - | 0.9 | - | 2.7 | RG-174 A/U | unipole | ● |
| | | 130 | 1 | - | 3 | 2.7 | 25 | - | 0.7 | - | 2.1 | 140 470 | unipole | ● |
| | | 130 | 2 | - | 3 | 2.7 | 30 | - | 1.0 | - | 3.0 | on request | unipole | ● |
| | | 140 | 2 | - | 4 | 3.7 | 40 | - | 0.8 | - | 2.4 | on request | unipole | ● |
| | | 140 | 3 | - | 4 | 3.7 | 43 | - | 1.1 | - | 3.3 | on request | unipole | ● |
| | | 160 | 3 | - | 6 | 5.5 | 65 | - | 0.8 | - | 2.4 | on request | unipole | ● |
| | | 140 | 4 | - | 4 | 3.7 | 46 | - | 1.4 | - | 4.2 | on request | unipole | ◐ |
| | | 160 | 4 | - | 6 | 5.5 | 70 | - | 1.3 | - | 3.9 | on request | unipole | ◐ |
| | | 112 | 5 | - | 12 | 12 | 230 | - | 0.7 | - | 2.1 | on request | unipole | ○ |



EINPOLIG / HOCHSTROM | UNIPOLE / HIGH CURRENT
KONFEKTIONIERUNGSANLEITUNG | ASSEMBLING INSTRUCTIONS



| Reference | | | Contact ø (mm) | Unisolated length (mm) | | |
|-----------|------|----------|-------------------|------------------------|-----|------|
| Series | Type | Cable | | A | B | C |
| 0S/0E | 116 | one-lead | 1.6 | 3.0 | 4.5 | 6.0 |
| 1S/1E | 120 | one-lead | 2.0 | 3.0 | 5.0 | 7.0 |
| 1S/1E | 130 | one-lead | 3.0 | 3.0 | 5.0 | 7.0 |
| 2S/2E | 130 | one-lead | 3.0 | 5.0 | 6.0 | 9.0 |
| 2S/2E | 140 | one-lead | 4.0 | 4.0 | 6.0 | 9.0 |
| 3S/3E | 140 | one-lead | 4.0 | 4.0 | 9.0 | 12.0 |
| 3S/3E | 160 | one-lead | 6.0 | 5.0 | 9.0 | 12.0 |
| 4S/4E | 140 | one-lead | 4.0 | 3.5 | 8.0 | 12.0 |
| 4S/4E | 160 | one-lead | 6.0 | 5.5 | 8.0 | 12.0 |
| 5S/5E | 112 | one-lead | 12.0 | 16.0 | - | 19.0 |



Note: The dimensions are standard values and may vary depending on the cable quality.

Die Abmessungen sind Richtwerte und können sich je nach Kabelqualität ändern.

**Steckverbindungen
Connectors
Kontaktfiguration
Contactfiguration
Kabel
Cable
Konfektionierungsanleitung
Assembling Instructions**



**GEMISCHT / MEHRPOLIG HOCHSTROM
HYBRID / MULTIPOLE HIGH CURRENT**

GEMISCHT/MEHRPOLIG HOCHSTROM | HYBRIDE/MULTIPOLE HIGH CURRENT
BAUFORM S-SERIE | MODEL S-SERIES



FFA Straight plug, cable collet



| Reference | | Dimensions (mm) | | | |
|-----------|--------|-----------------|-----|----|----|
| Model | Series | A | L | M | S2 |
| FFA | 2S | 14.8 | 52 | 40 | 11 |
| FFA | 3S ✓ | 17.8 | 61 | 46 | 14 |
| FFA | 4S ✓ | 24.8 | 77 | 59 | 19 |
| FFA | 5S ✓ | 35.1 | 103 | 78 | 29 |



FFA Straight plug with oversize cable collet

| Reference | | Dimensions (mm) | | | | | |
|-----------|--------|-----------------|------|-----|-----|------|----|
| Model | Series | A | B | L | M | S1 | S2 |
| FFA | 2S ✓ | 14.8 | 18.0 | 67 | 55 | 14.0 | 14 |
| FFA | 3S ✓ | 17.8 | 21.0 | 85 | 70 | 19.0 | 19 |
| FFA | 4S ✓ | 24.8 | 31.8 | 107 | 89 | 28.5 | 29 |
| FFA | 5S ✓ | 35.1 | 41.8 | 138 | 113 | 37.5 | 38 |

Note: the fitting of oversize collets onto this model allows them to be fitted to the cables that can be accommodated by the next housing size up

FFA Straight plug, cable collet and nut for fitting a bend relief



| Reference | | Dimensions (mm) | | | |
|-----------|--------|-----------------|----|----|----|
| Model | Series | A | L | M | S2 |
| FFA | 2S ✓ | 14.8 | 52 | 40 | 12 |
| FFA | 3S ✓ | 17.8 | 61 | 46 | 14 |
| FFA | 4S ✓ | 24.8 | 77 | 59 | 20 |

Note: the bend relief must be ordered separately (see page 80)

FFP Straight plug, cable collet and inner anti-rotating device



| Reference | | Dimensions (mm) | | | |
|-----------|--------|-----------------|----|----|----|
| Model | Series | A | L | M | S2 |
| FFP | 2S | 14.8 | 52 | 40 | 11 |
| FFP | 3S ✓ | 17.8 | 61 | 46 | 14 |
| FFP | 4S ✓ | 24.8 | 77 | 59 | 19 |



Part number example see page 3



GEMISCHT/MEHRPOLIG HOCHSTROM | HYBRIDE/MULTIPOLE HIGH CURRENT BAUFORM S-SERIE | MODEL S-SERIES

FFB Straight plug, cable collet and safety locking ring

| Reference | | Dimensions (mm) | | | |
|-----------|--------|-----------------|------|------|------|
| Model | Series | A | L | M | S2 |
| FFB | 2S ✓ | 14.8 | 55.5 | 43.5 | 11.0 |
| FFB | 3S ✓ | 17.8 | 65.0 | 50.0 | 14.0 |



FFB Straight plug, cable collet and safety locking ring and nut for fitting a bend relief

| Reference | | Dimensions (mm) | | | |
|-----------|--------|-----------------|------|------|----|
| Model | Series | A | L | M | S2 |
| FFB | 2S | 14.8 | 55.5 | 43.5 | 12 |
| FFB | 3S | 17.8 | 65.0 | 50.0 | 14 |



Note: series 2S and 3S are available on request
the bend relief must be ordered separately (see page 80)

FLA Elbow (90°) plug, cable collet

| Reference | | Dimensions (mm) | | | | | | |
|-----------|--------|-----------------|----|------|------|------|----|----|
| Model | Series | A | A1 | H | L | M | S1 | S2 |
| FLA | 2S | 20 | 20 | 37.0 | 31.0 | 19.0 | 13 | 11 |
| FLA | 3S | 21 | 21 | 44.0 | 38.5 | 23.5 | 15 | 14 |
| FLA | 4S ✓ | 28 | 28 | 56.0 | 49.0 | 31.0 | 20 | 19 |
| FLA | 5S ✓ | - | 37 | 76.5 | 65.0 | 40.0 | 30 | 29 |

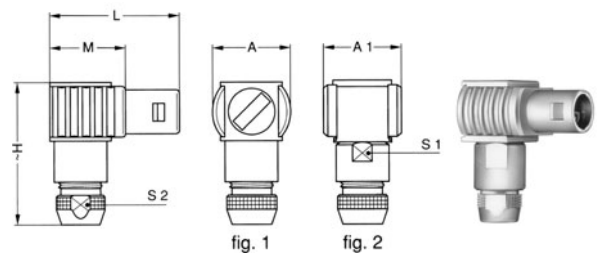

Note: fig.1 is used for the unipole type; fig.2 is used for the multipole type

ERA Fixed socket, nut fixing

| Reference | | Dimensions (mm) | | | | | | | | |
|-----------|--------|-----------------|------|---------|------|------|------|-----|------|----|
| Model | Series | A | B | e | E | L | L' | M | S1 | S3 |
| ERA | 2S | 18 | 19.5 | M15x1.0 | 8.5 | 24.5 | 26.0 | 1.8 | 13.5 | 17 |
| ERA | 3S ✓ | 22 | 25.2 | M18x1.0 | 11.5 | 29.0 | 30.0 | 2.0 | 16.5 | 22 |
| ERA | 4S ✓ | 28 | 32.0 | M25x1.0 | 12.0 | 34.0 | 36.0 | 2.5 | 23.5 | 30 |
| ERA | 5S ✓ | 40 | 40.0 | M35x1.0 | 15.5 | 45.0 | 78.5 | 3.0 | 33.5 | - |



Note: the 5S series is delivered with a tapered washer and a round nut
1 unipole model

✓ Bei Lemo vorhanden | available at Lemo

GEMISCHT/MEHRPOLIG HOCHSTROM | HYBRIDE/MULTIPOLE HIGH CURRENT
BAUFORM S-SERIE | MODEL S-SERIES



ERN Fixed socket, nut fixing, with earthing tag

| Reference | | Dimensions (mm) | | | | | | | | |
|-----------|--------|-----------------|------|---------|------|------|------|-----|------|----|
| Model | Series | A | B | e | E | L | L' | M | S1 | S3 |
| ERN | 2S ✓ | 18 | 19.5 | M15x1.0 | 8.5 | 26.3 | 26.3 | 1.8 | 13.5 | 17 |
| ERN | 3S | 22 | 25.2 | M18x1.0 | 11.5 | 29.8 | 30.0 | 2.0 | 16.5 | 22 |

Note: ¹ unipole model



EHP Fixed socket, nut fixing, protruding shell

| Reference | | Dimensions (mm) | | | | | | | | |
|-----------|--------|-----------------|------|---------|---|----|----|------|----|----|
| Model | Series | A | B | e | E | L | L' | M | S1 | S3 |
| EHP | 3S ✓ | 22 | 25.2 | M18x1.0 | 4 | 29 | 30 | 18.7 | - | 22 |

Note: ¹ unipole model



EBC Fixed socket with square flange, protruding shell and screw fixing

| Reference | | Dimensions (mm) | | | | | | | | |
|-----------|--------|-----------------|----|-----|------|------|------|------|-----|--|
| Model | Series | A | B | C | H | L | L' | M | N | |
| EBC | 2S | 22 | 15 | 3.2 | 15.5 | 24.5 | 26.0 | 18.5 | 4.4 | |
| EBC | 3S | 25 | 18 | 3.2 | 18.0 | 29.0 | 30.0 | 23.5 | 3.0 | |
| EBC | 5S ✓ | 45 | 40 | 4.3 | 36.8 | 45.0 | 53.5 | 15.0 | 4.0 | |

Note: ¹ unipole model



ERD Fixed socket with two nuts (back panel mounting)

| Reference | | Dimensions (mm) | | | | | | | | |
|-----------|--------|-----------------|------|---------|------|------|----|-----|------|----|
| Model | Series | A | B | e | E | L | L' | M | S1 | S3 |
| ERD | 2S | 20 | 19.5 | M15x1.0 | 6.5 | 24.5 | 26 | 3.5 | 13.5 | 17 |
| ERD | 3S ✓ | 24 | 25.2 | M18x1.0 | 9.0 | 29.0 | 30 | 4.5 | 16.5 | 22 |
| ERD | 4S | 30 | 32.0 | M25x1.0 | 10.0 | 34.0 | 36 | 4.5 | 23.5 | 30 |

Note: the 3S and 4S series are delivered with a conical nut ¹ unipole model



Part number example see page 3



GEMISCHT/MEHRPOLIG HOCHSTROM | HYBRIDE/MULTIPOLE HIGH CURRENT BAUFORM S-SERIE | MODEL S-SERIES

ECP Fixed socket with two nuts, long threaded shell, with straight contact for printed circuit (back panel mounting)

| Reference | | Dimensions (mm) | | | | | | | |
|-----------|--------|-----------------|------|---------|----|-----|----|------|----|
| Model | Series | A | B | e | E | M | N | S1 | S3 |
| ECP | 2S ✓ | 20 | 19.5 | M15x1.0 | 11 | 3.5 | 20 | 13.5 | 17 |
| ECP | 3S ✓ | 24 | 25.2 | M18x1.0 | 14 | 4.5 | 24 | 16.5 | 22 |

Note: This contact type is available for all EXX socket models. Length 'L' depends on the number of contacts. The 3S-series is delivered with a conical nut.

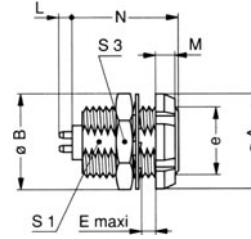

PCA Free socket, cable collet

| Reference | | Dimensions (mm) | | |
|-----------|--------|-----------------|----|----|
| Model | Series | A | L | S2 |
| PCA | 2S | 14.8 | 50 | 11 |
| PCA | 3S ✓ | 17.8 | 59 | 14 |
| PCA | 4S ✓ | 24.8 | 75 | 19 |
| PCA | 5S ✓ | 34.7 | 99 | 29 |

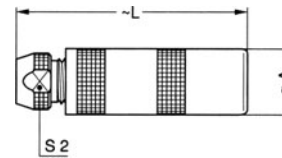

PCA Free socket with oversize cable collet

| Reference | | Dimensions (mm) | | | | |
|-----------|--------|-----------------|------|-----|------|----|
| Model | Series | A | B | L | S1 | S2 |
| PCA | 2S ✓ | 14.8 | 18.0 | 65 | 14.0 | 14 |
| PCA | 3S ✓ | 17.8 | 21.0 | 83 | 19.0 | 19 |
| PCA | 4S ✓ | 24.8 | 31.8 | 105 | 28.5 | 29 |

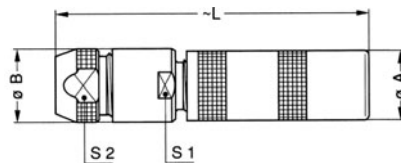

Note: the fitting of oversize collets onto this model allows it to be fitted to the cables that can be accommodated by the next housing size up

PCA Free socket, cable collet and nut for fitting a bend relief

| Reference | | Dimensions (mm) | | |
|-----------|--------|-----------------|----|----|
| Model | Series | A | L | S2 |
| PCA | 2S ✓ | 14.8 | 50 | 12 |
| PCA | 3S ✓ | 17.8 | 59 | 14 |
| PCA | 4S ✓ | 24.8 | 75 | 20 |

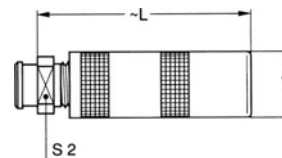

Note: the bend relief must be ordered separately (see page 80)

GEMISCHT/MEHRPOLIG HOCHSTROM | HYBRIDE/MULTIPOLE HIGH CURRENT
BAUFORM S-SERIE | MODEL S-SERIES



PSA Fixed socket, nut fixing, cable collet

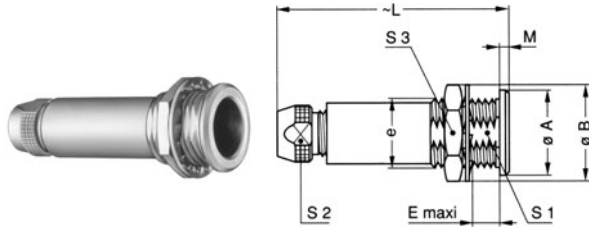

| Reference | | Dimensions (mm) | | | | | | | | |
|-----------|--------|-----------------|------|---------|------|----|-----|------|----|----|
| Model | Series | A | B | e | E | L | M | S1 | S2 | S3 |
| PSA | 2S | 18 | 19.5 | M15x1.0 | 8.5 | 50 | 1.8 | 13.5 | 11 | 17 |
| PSA | 3S ✓ | 22 | 25.2 | M18x1.0 | 11.5 | 59 | 2.0 | 16.5 | 14 | 22 |
| PSA | 4S ✓ | 28 | 32.0 | M25x1.0 | 12.0 | 75 | 2.5 | 23.5 | 19 | 30 |
| PSA | 5S ✓ | 40 | 40.0 | M35x1.0 | 15.5 | 99 | 3.0 | 33.5 | 29 | - |

Note: the 5S series is delivered with a tapered washer and a round nut

PSP Fixed socket, nut fixing, cable collet and inner anti-rotating device



| Reference | | Dimensions (mm) | | | | | | | | |
|-----------|--------|-----------------|------|---------|------|----|-----|------|----|----|
| Model | Series | A | B | e | E | L | M | S1 | S2 | S3 |
| PSP | 2S | 18 | 19.5 | M15x1.0 | 8.5 | 50 | 1.8 | 13.5 | 11 | 17 |
| PSP | 3S | 22 | 25.2 | M18x1.0 | 11.5 | 59 | 2.0 | 16.5 | 14 | 22 |
| PSP | 4S ✓ | 28 | 32.0 | M25x1.0 | 12.0 | 75 | 2.5 | 23.5 | 19 | 30 |

BAUFORM E-SERIE | MODEL E-SERIES

FFA Straight plug, cable collet – watertight



| Reference | | Dimensions (mm) | | | |
|-----------|--------|-----------------|----|------|----|
| Model | Series | A | L | M | S2 |
| FFA | 2E ✓ | 16 | 52 | 36.0 | 12 |
| FFA | 3E ✓ | 19 | 61 | 41.0 | 15 |
| FFA | 4E ✓ | 25 | 71 | 50.5 | 19 |
| FFA | 5E | 38 | 92 | 67.0 | 32 |

FFA Straight plug with oversize cable collet – watertight



| Reference | | Dimensions (mm) | | | | | |
|-----------|--------|-----------------|----|-----|----|----|----|
| Model | Series | A | B | L | M | S1 | S2 |
| FFA | 2E ✓ | 16 | 17 | 65 | 49 | 15 | 15 |
| FFA | 3E ✓ | 19 | 22 | 80 | 60 | 19 | 19 |
| FFA | 4E ✓ | 25 | 36 | 105 | 84 | 30 | 32 |

Note: the fitting of oversize collets onto this model allows them to be fitted to the cables that can be accommodated by the next housing size up

✓ Bei Lemo vorhanden | available at Lemo



Part number example see page 3



GEMISCHT/MEHRPOLIG HOCHSTROM | HYBRIDE/MULTIPOLE HIGH CURRENT

BAUFORM E-SERIE | MODEL E-SERIES

FFA straight plug, cable collet and nut for fitting a bend relief – watertight

| Reference | | Dimensions (mm) | | | |
|-----------|--------|-----------------|----|------|----|
| Model | Series | A | L | M | S2 |
| FFA | 2E ✓ | 16 | 52 | 36.0 | 12 |
| FFA | 3E ✓ | 19 | 60 | 40.0 | 15 |
| FFA | 4E ✓ | 25 | 71 | 50.5 | 19 |

Note: the bend relief must be ordered separately (see page 80)



FAA Fixed plug non-latching, nut fixing – watertight

| Reference | | Dimensions (mm) | | | | | | | | |
|-----------|--------|-----------------|------|---------|-----|------|------|------|------|----|
| Model | Series | A | B | e | E | L | L' | M | S1 | S3 |
| FAA | 2E | 25 | 27.5 | M20x1.0 | 4.0 | 27.0 | 27.0 | 18.0 | 18.5 | 24 |
| FAA | 3E ✓ | 31 | 34.5 | M24x1.0 | 4.5 | 32.5 | 32.5 | 22.5 | 22.5 | 30 |

Note: ¹ unipole model



FLA Elbow (90°) plug, cable collet – watertight

| Reference | | Dimensions (mm) | | | | | | | |
|-----------|--------|-----------------|------|----|----|------|----|----|----|
| Model | Series | A | D | H | L | M | S1 | S2 | S3 |
| FLA | 2E | 17.5 | 10.5 | 40 | 51 | 35.0 | 15 | 12 | 13 |
| FLA | 3E ✓ | 21.0 | 11.5 | 47 | 60 | 40.0 | 18 | 15 | 15 |
| FLA | 4E | 27.5 | 15.5 | 57 | 72 | 51.5 | 24 | 19 | 20 |



ERA Fixed socket, nut fixing – watertight

| Reference | | Dimensions (mm) | | | | | | | | |
|-----------|--------|-----------------|------|---------|----|------|----|-----|------|----|
| Model | Series | A | B | e | E | L | L' | M | S1 | S3 |
| ERA | 2E ✓ | 25 | 27.5 | M20x1.0 | 9 | 28.5 | 30 | 5.0 | 18.5 | 24 |
| ERA | 3E ✓ | 31 | 34.5 | M24x1.0 | 11 | 34.0 | 35 | 6.0 | 22.5 | 30 |
| ERA | 4E ✓ | 37 | 41.5 | M30x1.0 | 9 | 36.0 | 38 | 6.5 | 28.5 | 36 |
| ERA | 5E | 55 | 54.0 | M45x1.5 | 10 | 44.5 | 78 | 9.0 | 42.5 | - |

Note: the 5E series is delivered with a round nut.
¹ unipole model

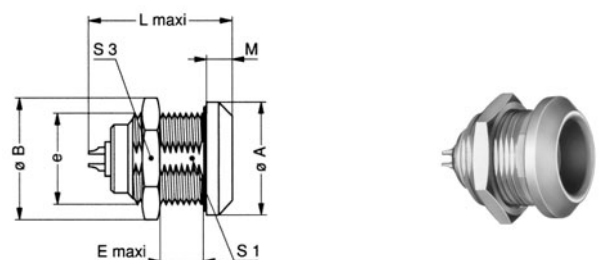

GEMISCHT/MEHRPOLIG HOCHSTROM | HYBRIDE/MULTIPOLE HIGH CURRENT
BAUFORM E-SERIE | MODEL E-SERIES

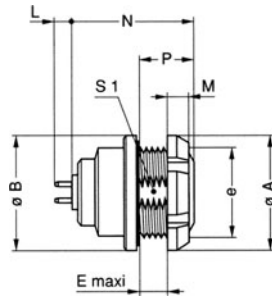

EEP Fixed socket, nut fixing, with straight contact for printed circuit (back panel mounting) – watertight

| Reference | | Dimensions (mm) | | | | | | | |
|-----------|--------|-----------------|----|---------|---|-----|------|----|------|
| Model | Series | A | B | e | E | M | N | P | S1 |
| EEP | 2E ✓ | 25 | 25 | M20x1.0 | 5 | 3.5 | 25.5 | 10 | 18.5 |
| EEP | 3E ✓ | 30 | 31 | M24x1.0 | 7 | 4.5 | 30.5 | 12 | 22.5 |

Note: length 'L' depends on the number of contacts

PCA Free socket, cable collet – watertight

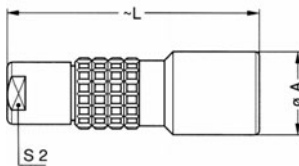

| Reference | | Dimensions (mm) | | |
|-----------|--------|-----------------|------|----|
| Model | Series | A | L | S2 |
| PCA | 2E ✓ | 19 | 54.0 | 12 |
| PCA | 3E ✓ | 23 | 65.0 | 15 |
| PCA | 4E ✓ | 29 | 75.5 | 19 |
| PCA | 5E | 42 | 95.0 | 32 |

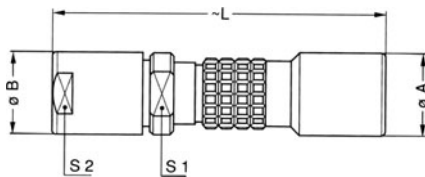

PCA Free socket with oversize cable collet – watertight

| Reference | | Dimensions (mm) | | | | |
|-----------|--------|-----------------|----|-----|----|----|
| Model | Series | A | B | L | S1 | S2 |
| PCA | 2E ✓ | 19 | 17 | 67 | 15 | 15 |
| PCA | 3E ✓ | 23 | 22 | 84 | 19 | 19 |
| PCA | 4E ✓ | 29 | 36 | 109 | 30 | 32 |

Note: the fitting of oversize collets onto this model allows them to be fitted to the cables that can be accommodated by the next housing size up

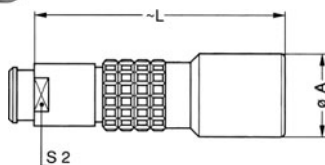

PCA Free socket, cable collet and nut for fitting a bend relief – watertight

| Reference | | Dimensions (mm) | | |
|-----------|--------|-----------------|------|----|
| Model | Series | A | L | S2 |
| PCA | 2E ✓ | 19 | 54.0 | 12 |
| PCA | 3E ✓ | 23 | 64.0 | 15 |
| PCA | 4E ✓ | 29 | 75.5 | 19 |

Note: the bend relief must be ordered separately (see page 80)



Part number example see page 3



GEMISCHT/MEHRPOLIG HOCHSTROM | HYBRIDE/MULTIPOLE HIGH CURRENT BAUFORM E-SERIE | MODEL E-SERIES

PSA Fixed socket, nut fixing, cable collet – watertight

| Reference | | Dimensions (mm) | | | | | | | | |
|-----------|--------|-----------------|------|---------|----|------|-----|------|----|----|
| Model | Series | A | B | e | E | L | M | S1 | S2 | S3 |
| PSA | 2E | 25 | 27.5 | M20x1.0 | 9 | 54.0 | 5.0 | 18.5 | 12 | 24 |
| PSA | 3E | 31 | 34.5 | M24x1.0 | 11 | 65.0 | 6.0 | 22.5 | 15 | 30 |
| PSA | 4E ✓ | 37 | 41.5 | M30x1.5 | 9 | 75.5 | 6.5 | 28.5 | 19 | 36 |
| PSA | 5E | 51 | 54.0 | M45x1.5 | 10 | 95.0 | 9.0 | - | 32 | 54 |

Note: the 5E series is delivered with a round nut



HGP Fixed socket, nut fixing, watertight and vacuumtight

| Reference | | Dimensions (mm) | | | | | | | | |
|-----------|--------|-----------------|------|---------|------|------|------|-----|------|----|
| Model | Series | A | B | e | E | L | L' | M | S1 | S3 |
| HGP | 2E ✓ | 25 | 27.5 | M20x1.0 | 10.5 | 32.5 | 28.0 | 5.0 | 18.5 | 24 |
| HGP | 3E ✓ | 31 | 34.5 | M24x1.0 | 15.5 | 39.5 | 38.5 | 6.0 | 22.5 | 30 |
| HGP | 4E | 37 | 41.5 | M30x1.0 | 17.5 | 43.0 | 44.0 | 6.5 | 28.5 | 36 |
| HGP | 5E | 55 | 54.0 | M45x1.5 | 20.0 | 52.0 | 76.0 | 9.0 | 42.5 | - |

Note: the 5E series is delivered with a round nut
 1 unipole model



BAUFORM B-SERIE | MODEL B-SERIES

FGG Straight plug with key (G) or keys (code A to M and R)

| Reference | | Dimensions (mm) | | | | |
|-----------|--------|-----------------|-----|----|----|----|
| Model | Series | A | L | M | S1 | S2 |
| FGG | 1B ✓ | 12 | 43 | 32 | 10 | 9 |
| FGG | 2B ✓ | 15 | 49 | 37 | 13 | 12 |
| FGG | 3B ✓ | 18 | 58 | 43 | 15 | 14 |
| FGG | 4B ✓ | 25 | 75 | 57 | 21 | 20 |
| FGG | 5B ✓ | 35 | 103 | 78 | 31 | 30 |



GEMISCHT/MEHRPOLIG HOCHSTROM | HYBRIDE/MULTIPOLE HIGH CURRENT
BAUFORM B-SERIE | MODEL B-SERIES



EGG Fixed socket with nut fixing and key (G) or keys (code A to M and R)



| Reference | | Dimensions (mm) | | | | | | | | |
|-----------|--------|-----------------|----|---------|------|------|-----|------|------|----|
| Model | Series | A | B | e | E | L | M | N | S1 | S3 |
| EGG | 1B ✓ | 14 | 16 | M12x1.0 | 7.5 | 21.7 | 1.5 | 19.5 | 10.5 | 14 |
| EGG | 2B ✓ | 18 | 20 | M15x1.0 | 8.5 | 25.0 | 1.8 | 21.5 | 13.5 | 17 |
| EGG | 3B ✓ | 22 | 25 | M18x1.0 | 11.5 | 30.0 | 2.0 | 25.5 | 16.5 | 22 |
| EGG | 4B ✓ | 28 | 32 | M25x1.0 | 12.0 | 34.5 | 2.5 | 30.5 | 23.5 | 30 |
| EGG | 5B ✓ | 40 | 40 | M35x1.0 | 15.5 | 45.5 | 3.0 | 36.5 | 33.5 | - |

PKG Fixed socket with nut fixing and key (G) or keys (code A to M and R) and cable collet



| Reference | | Dimensions (mm) | | | | | | | | |
|-----------|--------|-----------------|------|---------|------|------|-----|------|----|----|
| Model | Series | A | B | e | E | L | M | S1 | S2 | S3 |
| PKG | 1B ✓ | 14 | 16.0 | M12x1.0 | 7.5 | 40.5 | 1.5 | 10.5 | 9 | 14 |
| PKG | 2B ✓ | 18 | 19.5 | M15x1.0 | 8.5 | 47.0 | 1.8 | 13.5 | 12 | 17 |
| PKG | 3B ✓ | 22 | 25.0 | M18x1.0 | 11.5 | 56.0 | 2.0 | 16.5 | 14 | 22 |
| PKG | 4B ✓ | 28 | 32.0 | M25x1.0 | 12.5 | 73.0 | 2.5 | 23.5 | 20 | 30 |
| PKG | 5B ✓ | 40 | 40.0 | M35x1.0 | 11.0 | 99.0 | 3.0 | 33.5 | 30 | - |

PFG Fixed socket with two nuts, key (G) or keys (code A to M and R) and cable collet



| Reference | | Dimensions (mm) | | | | | | | | |
|-----------|--------|-----------------|----|---------|------|------|-----|------|----|----|
| Model | Series | A | B | e | E | L | M | S1 | S2 | S3 |
| PFG | 1B ✓ | 16 | 16 | M12x1.0 | 5.0 | 40.5 | 3.5 | 10.5 | 9 | 14 |
| PFG | 2B ✓ | 20 | 20 | M15x1.0 | 6.5 | 47.0 | 3.5 | 13.5 | 12 | 17 |
| PFG | 3B ✓ | 24 | 25 | M18x1.0 | 9.0 | 56.0 | 4.5 | 16.5 | 14 | 22 |
| PFG | 4B ✓ | 30 | 32 | M25x1.0 | 11.0 | 73.0 | 4.5 | 23.5 | 20 | 30 |

PHG Free socket with key (G) or keys (code A to M and R) and cable collet



| Reference | | Dimensions (mm) | | | |
|-----------|--------|-----------------|------|----|----|
| Model | Series | A | L | S1 | S2 |
| PHG | 1B ✓ | 12.5 | 40.5 | 10 | 9 |
| PHG | 2B ✓ | 16.5 | 47.0 | 13 | 12 |
| PHG | 3B ✓ | 19.0 | 56.0 | 15 | 14 |
| PHG | 4B ✓ | 24.4 | 73.0 | 21 | 20 |
| PHG | 5B ✓ | 34.2 | 99.0 | 31 | 30 |



Part number example see page 3



GEMISCHT/MEHRPOLIG HOCHSTROM | HYBRIDE/MULTIPOLE HIGH CURRENT
BAUFORM K-SERIE | MODEL K-SERIES

FGG Straight plug with key (G) or keys (code A to F and L) and cable collet – watertight

| Reference | | Dimensions (mm) | | | | |
|-----------|--------|-----------------|------|----|------|------|
| Model | Series | A | C | L | M | S2 |
| FGG | 1K ✓ | 13 | 7.1 | 42 | 28.0 | 8.9 |
| FGG | 2K ✓ | 16 | 9.2 | 52 | 36.0 | 11.9 |
| FGG | 3K ✓ | 19 | 10.5 | 61 | 41.0 | 14.9 |
| FGG | 4K ✓ | 25 | 14.0 | 71 | 50.5 | 18.9 |
| FGG | 5K ✓ | 38 | 23.5 | 92 | 67.0 | 31.9 |

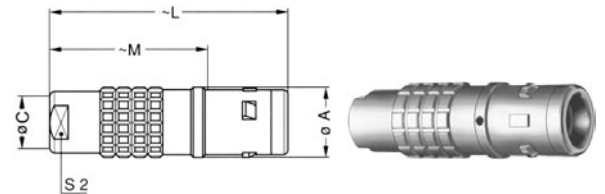

FGG Straight plug with key (G) or keys (code A to F and L) and oversize collet – watertight

| Reference | | Dimensions (mm) | | | | | | |
|-----------|--------|-----------------|------|------|-----|----|------|------|
| Model | Series | A | B | C | L | M | S1 | S2 |
| FGG | 1K ✓ | 13 | 14.5 | 9.2 | 55 | 41 | 11.9 | 11.9 |
| FGG | 2K ✓ | 16 | 17.0 | 10.5 | 65 | 49 | 14.9 | 14.9 |
| FGG | 3K ✓ | 19 | 22.0 | 15.3 | 80 | 60 | 18.9 | 18.9 |
| FGG | 4K ✓ | 25 | 36.0 | 23.5 | 105 | 84 | 30.0 | 31.9 |



FGG Straight plug with key (G) or keys (code A to F and L) and bend relief – watertight

| Reference | | Dimensions (mm) | | | | |
|-----------|--------|-----------------|------|------|------|------|
| Model | Series | A | C | L | M | S2 |
| FGG | 1K ✓ | 13 | 7.1 | 45.0 | 31.0 | 9.0 |
| FGG | 2K ✓ | 16 | 8.7 | 49.0 | 33.0 | 11.9 |
| FGG | 3K ✓ | 19 | 10.8 | 62.0 | 42.0 | 15.0 |
| FGG | 4K ✓ | 25 | 15.3 | 78.5 | 50.5 | 18.9 |



Note: the bend relief must be ordered separately (see page 82)

EGG Fixed socket with nut fixing and key (G) or keys (code A to F and L) – watertight

| Reference | | Dimensions (mm) | | | | | | | |
|-----------|--------|-----------------|------|---------|----|------|-----|------|----|
| Model | Series | A | B | e | E | L | M | S1 | S3 |
| EGG | 1K ✓ | 20 | 21.5 | M16x1.0 | 9 | 26.0 | 4.5 | 14.5 | 19 |
| EGG | 2K ✓ | 25 | 27.5 | M20x1.0 | 9 | 29.0 | 5.0 | 18.5 | 24 |
| EGG | 3K ✓ | 31 | 34.5 | M24x1.0 | 11 | 34.5 | 6.0 | 22.5 | 30 |
| EGG | 4K ✓ | 37 | 41.5 | M30x1.0 | 9 | 35.0 | 6.5 | 28.5 | 36 |
| EGG | 5K ✓ | 54 | 54.0 | M45x1.5 | 10 | 43.5 | 9.0 | 42.5 | 54 |



GEMISCHT/MEHRPOLIG HOCHSTROM | HYBRIDE/MULTIPOLE HIGH CURRENT
BAUFORM K-SERIE | MODEL K-SERIES



PKG Fixed socket, nut fixing, with key (G) or keys (code A to F and L) and cable collet – watertight

| Reference | | Dimensions (mm) | | | | | | | | |
|-----------|--------|-----------------|------|---------|----|------|-----|------|----|----|
| Model | Series | A | B | e | E | L | M | S1 | S2 | S3 |
| PKG | 1K ✓ | 20 | 21.5 | M16x1.0 | 9 | 45.0 | 4.5 | 14.5 | 9 | 19 |
| PKG | 2K ✓ | 25 | 27.5 | M20x1.0 | 9 | 54.0 | 5.0 | 18.5 | 12 | 24 |
| PKG | 3K ✓ | 31 | 34.5 | M24x1.0 | 11 | 65.0 | 6.0 | 22.5 | 15 | 30 |
| PKG | 4K ✓ | 37 | 41.5 | M30x1.0 | 9 | 75.5 | 6.5 | 28.5 | 19 | 36 |
| PKG | 5K ✓ | 55 | 54.0 | M45x1.0 | 15 | 95.0 | 9.0 | 42.5 | 32 | - |



PHG Free socket, nut fixing, with key (G) or keys (code A to F and L) and cable collet – watertight

| Reference | | Dimensions (mm) | | | |
|-----------|--------|-----------------|------|------|------|
| Model | Series | A | C | L | S2 |
| PHG | 1K ✓ | 15 | 7.1 | 45.0 | 8.9 |
| PHG | 2K ✓ | 19 | 9.2 | 54.0 | 11.9 |
| PHG | 3K ✓ | 23 | 10.5 | 65.0 | 14.9 |
| PHG | 4K ✓ | 29 | 14.0 | 75.5 | 18.9 |
| PHG | 5K ✓ | 42 | 23.5 | 95.0 | 31.9 |



PHG Free socket, nut fixing, with key (G) or keys (code A to F and L) and oversize collet – watertight

| Reference | | Dimensions (mm) | | | | | |
|-----------|--------|-----------------|------|------|-------|------|------|
| Model | Series | A | B | C | L | S1 | S2 |
| PHG | 1K ✓ | 15 | 14.5 | 9.2 | 58.0 | 11.9 | 11.9 |
| PHG | 2K ✓ | 19 | 17.0 | 10.5 | 67.0 | 14.9 | 14.9 |
| PHG | 3K ✓ | 23 | 22.0 | 14.0 | 86.0 | 18.9 | 18.9 |
| PHG | 4K ✓ | 29 | 36.0 | 14.0 | 123.5 | 30.0 | 31.9 |



PHG Free socket, nut fixing, with key (G) or keys (code A to F and L) and nut for fitting a bend relief – watertight

| Reference | | Dimensions (mm) | | | |
|-----------|--------|-----------------|------|------|------|
| Model | Series | A | C | L | S2 |
| PHG | 1K ✓ | 15 | 7.1 | 48.0 | 9.0 |
| PHG | 2K ✓ | 19 | 9.2 | 57.0 | 11.9 |
| PHG | 3K ✓ | 23 | 10.5 | 66.0 | 15.0 |
| PHG | 4K ✓ | 29 | 14.0 | 75.5 | 18.9 |

Note: the bend relief must be ordered separately (see page 80)



Part number example see page 3



GEMISCHT/MEHRPOLIG HOCHSTROM | HYBRIDE/MULTIPOLE HIGH CURRENT
KONTAKTFIGURATION SERIE S+E | CONTACTFIGURATION SERIES S+E

| Soldersided seen | | Order-No. | Size | Impedance | Contact- ϕ | Max. conductor- ϕ | Valid current | Supply voltage | | Test voltage | | Cable-order-no. | Type of insulation | Delivery time |
|------------------|----------------|-----------|------|-----------|-------------------|------------------------|---------------|----------------|------------|--------------|------------|--------------------|--------------------|---------------|
| Male contact | Female contact | | | | | | | U_s (KV dc) | K-M | K-K | K-M | | | |
| Ω | mm | mm | A | K-K | K-M | K-K | K-M | | | | | | | |
| | | 702 | 2 | - | 1.3 3.0 | 1.0 2.7 | 15 - | 0.6 3.5 | 0.8 5.0 | 1.8 - | 2.4 - | 020 140 106 330 | mixed | ● |
| | | 702 | 3 | - | 1.3 2.0 2.0 | 1.0 1.8 1.8 | 10 18 | 3.0 0.35 | 3.0 0.5 | 4.5 1.0 | 4.5 1.5 | 317 440 | mixed | ●○ |
| | | 703 | 3 | - | 1.3 1.3 | 1.0 1.0 | 3 14 | 3.0 0.7 | 3.0 1.0 | 4.5 2.1 | 4.5 3.0 | 317 440 | mixed | ●○ |
| | | 704 | 3 | - | 1.3 1.3 | 1.0 1.0 | 3 10 | 3.0 0.35 | 3.0 0.5 | 4.5 1.0 | 4.5 1.5 | 317 440 | mixed | ● |
| | | 705 | 3 | - | 1.3 1.3 | 1.0 1.0 | 3 9 | 3.0 0.35 | 3.0 0.5 | 4.5 1.0 | 4.5 1.5 | 317 480 | mixed | ● |
| | | 706 | 3 | - | 1.3 1.3 | 1.0 1.0 | 3 8 | 3.0 0.35 | 3.0 0.5 | 4.5 1.0 | 4.5 1.5 | 317 480 | mixed | ● |
| | | 707 | 3 | - | 1.3 1.3 | 1.0 1.0 | 3 8 | 3.0 0.35 | 3.0 0.5 | 4.5 1.0 | 4.5 1.5 | 317 480 | mixed | ● |
| | | 708 | 3 | - | 1.3 0.9 | 1.0 0.8 | 8 6 | 3.0 0.25 | 3.0 0.4 | 4.5 0.8 | 4.5 1.2 | 317 480 | mixed | ● |
| | | 732 | 3 | - | 1.3 1.3 | 1.0 1.0 | 10 14 | 3.0 0.7 | 3.0 1.0 | 4.5 2.1 | 4.5 3.0 | 321 740 | mixed | ● |
| | | 734 | 3 | - | 1.3 1.3 | 1.0 1.0 | 3 10 | 3.0 0.7 | 3.0 1.0 | 4.5 2.1 | 4.5 3.0 | 321 740 | mixed | ● |
| | | 702 | 4 | - | 2.0 3.0 | 1.8 2.7 | 6 22 | 3.0 0.7 | 3.0 1.0 | 4.5 2.1 | 4.5 3.0 | RG-cable | mixed | ● |
| | | 703 | 4 | - | 2.0 2.0 | 1.8 1.8 | 6 16 | 3.0 0.7 | 3.0 1.0 | 4.5 2.1 | 4.5 3.0 | on request | mixed | ● |
| | | 704 | 4 | - | 2.0 1.3 | 1.8 1.0 | 6 13 | 3.0 0.9 | 3.0 1.3 | 4.5 2.7 | 4.5 3.9 | on request | mixed | ● |

GEMISCHT/MEHRPOLIG HOCHSTROM | HYBRIDE/MULTIPOLE HIGH CURRENT
KONTAKTFIGURATION SERIE S+E | CONTACTFIGURATION SERIES S+E



| Soldersided seen | | Order-No. | Size | Impedance | Contact- ϕ | Max. conductor- ϕ | Valid current | Supply voltage U_s (kV dc) | | Test voltage U_e (kV dc) | | Cable-order-no. | Type of insulation | Delivery time |
|------------------|----------------|-----------|------|-----------|-----------------|------------------------|---------------|------------------------------|-----|----------------------------|------|-----------------|--------------------|---------------|
| Male contact | Female contact | | | | | | | K-K | K-M | K-K | K-M | | | |
| | | 705 | 4 | - | 2.0 | 1.8 | 6 | 3.0 | 3.0 | 4.5 | 4.5 | on request | mixed | ● |
| | | | | - | 1.3 | 1.0 | 11 | 0.7 | 1.0 | 8.0 | 8.0 | | | |
| | | 706 | 4 | - | 2.0 | 1.8 | 6 | 3.0 | 3.0 | 4.5 | 4.5 | on request | mixed | ● |
| | | | | - | 1.3 | 1.0 | 9 | 0.7 | 1.0 | 8.0 | 8.0 | | | |
| | | 707 | 4 | - | 2.0 | 1.8 | 6 | 3.0 | 3.0 | 4.5 | 4.5 | on request | mixed | ● |
| | | | | - | 1.3 | 1.0 | 9 | 0.7 | 1.0 | 8.0 | 8.0 | | | |
| | | 708 | 4 | - | 2.0 | 1.8 | 6 | 3.0 | 3.0 | 4.5 | 4.5 | on request | mixed | ● |
| | | | | - | 1.3 | 1.0 | 9 | 0.7 | 1.0 | 8.0 | 8.0 | | | |
| | | 709 | 4 | - | 2.0 | 1.8 | 6 | 3.0 | 3.0 | 4.5 | 4.5 | on request | mixed | ● |
| | | | | - | 0.9 | 0.7 | 7 | 0.7 | 1.0 | 2.1 | 3.0 | | | |
| | | 712 | 4 | - | 2.0 | 1.8 | 6 | 3.0 | 3.0 | 4.5 | 4.5 | on request | mixed | ● |
| | | | | - | 0.9 | 0.8 | 7 | 0.7 | 1.0 | 2.1 | 3.0 | | | |
| | | 734 | 4 | - | 2.0 | 1.8 | 14 | 3.0 | 3.0 | 4.5 | 4.5 | on request | mixed | ● |
| | | | | - | 1.3 | 1.0 | 13 | 0.7 | 1.0 | 2.1 | 3.1 | | | |
| | | 714 | 4 | - | 2.0 | 1.8 | 14 | 3.0 | 3.0 | 4.5 | 4.5 | on request | mixed | ● |
| | | | | - | 0.9 | 0.8 | 7 | 0.7 | 1.0 | 2.1 | 3.0 | | | |
| | | 735 | 4 | - | 2.0 | 1.8 | 14 | 3.0 | 3.0 | 4.5 | 4.5 | on request | mixed | ● |
| | | | | - | 1.3 | 1.0 | 11 | 0.7 | 1.0 | 2.1 | 3.0 | | | |
| | | 737 | 4 | - | 2.0 | 1.8 | 14 | 3.0 | 3.0 | 4.5 | 4.5 | on request | mixed | ● |
| | | | | - | 1.3 | 1.0 | 9 | 0.7 | 1.0 | 2.1 | 3.0 | | | |
| | | 742 | 4 | - | 2.0 | 1.8 | 15 | 3.0 | 3.0 | 4.5 | 4.5 | on request | mixed | ● |
| | | | | - | 0.9 | 1.0 | 7 | 0.7 | 1.0 | 2.1 | 3.0 | | | |
| | | 706 | 5 | - | 2.0 | 1.8 | 10 | 5.0 | 5.0 | 7.5 | 7.5 | on request | mixed | ○ |
| | | | | - | 2.0 | 1.8 | 10 | 0.8 | 1.0 | 14.0 | 14.0 | | | |



Part number example see page 3



GEMISCHT/MEHRPOLIG HOCHSTROM | HYBRIDE/MULTIPOLE HIGH CURRENT
KONTAKTFIGURATION SERIE S+E | CONTACTFIGURATION SERIES S+E

| Soldersided seen | | Order-No. | Size | Impedance | Contact- ϕ | Max. conductor- ϕ | Valid current | Supply voltage U_s (kV dc) | | Test voltage U_e (kV dc) | | Cable-order-no. | Type of insulation | Delivery time |
|------------------|----------------|-----------|------|-----------|-----------------|------------------------|---------------|------------------------------|-----|----------------------------|-----|-----------------|--------------------|---------------|
| Male contact | Female contact | | | | | | | K-K | K-M | K-K | K-M | | | |
| | | 708 | 5 | - | 2 | 1.8 | 10 | 5.0 | 5.0 | 7.5 | 7.5 | on request | mixed | ○ |
| | | 710 | 5 | - | 2 | 1.8 | 20 | 5.0 | 5.0 | 7.5 | 7.5 | on request | mixed | ○ |
| | | 724 | 5 | - | 2 | 1.8 | 10 | 5.0 | 5.0 | 7.5 | 7.5 | on request | mixed | ○ |
| | | 730 | 5 | - | 3 | 2.7 | 12 | 10 | 10 | 15 | 15 | on request | mixed | ○ |
| | | 733 | 5 | - | 2 | 1.8 | 6 | 5.0 | 5.0 | 7.5 | 7.5 | see catalogue | mixed | ○ |
| | | 736 | 5 | - | 2 | 1.8 | 15 | 5.0 | 5.0 | 7.5 | 7.5 | see catalogue | mixed | ○ |
| | | 738 | 5 | - | 2 | 1.8 | 6 | 5.0 | 5.0 | 7.5 | 7.5 | see catalogue | mixed | ○ |
| | | 740 | 5 | - | 2 | 1.8 | 20 | 5.0 | 5.0 | 7.5 | 7.5 | see catalogue | mixed | ○ |
| | | 754 | 5 | - | 2 | 1.8 | 6 | 5.0 | 5.0 | 7.5 | 7.5 | catalogue | mixed | ○ |
| | | 746 | 5S | - | 1.3 | 1.0 | 6 | 0.4 | 0.6 | 1.6 | 2.2 | 316 250 | mixed | ● |
| | | 760 | 5S | - | 2.0 | 1.8 | - | 3.5 | 5.0 | - | - | 106 330 | mixed | ● |

GEMISCHT/MEHRPOLIG HOCHSTROM | HYBRIDE/MULTIPOLE HIGH CURRENT
KONTAKTFIGURATION SERIE B+K | CONTACTFIGURATION SERIES B+K



| Soldersided seen | | Order-No. | Standart Group | Watertight Group | High Voltage (HV) | | | | | Low Voltage (LV) | | | | | | | | |
|------------------|----------------|-----------|----------------|------------------|-------------------|--------------|---------|----------------|------------|------------------|-----------|--------------|----|----------------|------------|--------------------------|----------------------|---------------|
| Male contact | Female contact | | | | Nb of contacts | ø Dielectric | AWG max | Us (kV r.m.s.) | Us (kV dc) | Nb of contacts | ø A | Contact Type | | Us (kV r.m.s.) | Us (kV dc) | Test Voltage (kV r.m.s.) | Test Voltage (kV dc) | Rated Current |
| | | | | | mm | | kV | kV | | mm | To solder | To crimp | kV | kV | kV | kV | A | |
| | | 702 | 1B | 1K | 1 | 2.0 | 26 | 2.1 | 3.0 | 2 | 1.3 | ● | ○ | 0.40 | 0.60 | 1.2 | 1.8 | 12.0 |
| | | 731 | 1B | 1K | 2 | 0.7 | - | - | - | 1 | 1.3 | ● | ○ | 0.40 | 0.60 | 1.2 | 1.8 | 12.0 |
| | | 704 | 2B | 2K | 1 | 2.0 | 20 | 2.1 | 3.0 | 4 | 0.7 | ● | ○ | 0.40 | 0.60 | 1.2 | 1.8 | 5.0 |
| | | 718 | 3B | - | 1 | 2.0 | 22 | 3.0 | - | 18 | 0.7 | ● | ● | - | 0.60 | - | 2.0 | 5.5 |
| | | 740 | 3B | - | 2 | 2.0 | 22 | 3.0 | - | 10 | 0.7 | ● | ● | - | 0.60 | - | 2.0 | 5.5 |
| | | 745 | 4B | 4K | 2 | 2.0 | 22 | 5.6 | 8.0 | 16 | 0.9 | ● | ● | 0.63 | 0.90 | 1.9 | 2.7 | 7.0 |
| | | 752 | 5B | 5K | 2 | 3.8 | 14 | 1.5 | 2.2 | 20 | 1.3 | ● | ● | 0.53 | 0.70 | 1.6 | 2.3 | 10.0 |
| | | | | | 2 | | | | | 1.6 | | ● | ○ | | | | | |
| | | 759 | 5B | 5K | 2 | 2.0 | 22 | 5.6 | 8.0 | 54 | 0.9 | ● | ● | 0.53 | 0.70 | 1.6 | 2.3 | 3.0 |



**GEMISCHT/MEHRPOLIG HOCHSTROM | HYBRIDE/MULTIPOLE HIGH CURRENT
PVC-ISOLIERTE KOMBINATIONSKABEL | PVC-INSULATED COMBINATION CABLES**

| | Lead Time | | Price | Order-No. | Amount of Order | Wave impedance | Constructed of | Twisting | Tape | Screen | | Outer Sheath | |
|---|-----------|------|-------|-----------|-----------------|------------------|--|-----------------------|------------|--------|--------|--------------|----|
| | Stk. | Req. | €/m | | | | | | | Mat. | Mat. | Ø | |
|  | | | | | m | $\Omega (\pm 2)$ | | | | | | | mm |
|  | x | - | 3.38 | 317 440 | 20/100 | 50 | 1 coax cable type RG 174 A/U as well as 4 control wires 14x0.15 mm cross section 0.25 mm ² | RG 174+ control wires | PETP-Folie | CuSn | PVC gr | 7.2 | |
|  | x | - | 4.97 | 317 480 | 20/100 | 50 | 1 coax cable type RG 174 A/U as well as 8 control wires 14x0.15 mm cross section 0.25 mm ² | RG 174+ control wires | PETP-Folie | CuSn | PVC gr | 7.3 | |
|  | x | - | 6.03 | 417 410 | 20/100 | 50 | 1 coax cable type RG 174 A/U as well as 14 control wires 14x0.15 mm cross section 0.25 mm ² | RG 174+ control wires | PETP-Folie | CuSn | PVC gr | 10.0 | |
|  | x | - | 5.58 | 321 740 | 20/100 | 50 | 1 coax cable type RG 174 A/U as well as 6 control wires 18x0.10 mm cross section 0.14 mm ² | RG 174+ control wires | PETP-Folie | CuSn | PVC bk | 8.0 | |



Due to different cables,
 please ask for the stripping length





Housings (Y-series)



| Reference | Material |
|-----------|----------|
| C | Brass |

Detailed characteristics of these materials are presented on table.

Insulators (Y-series)



| Reference | Material or form | Note |
|-----------|------------------|------|
| L | PEEK | ● |
| T | PTFE | ● |

Detailed characteristics of these materials are presented on table.

Contacts (Y-series)

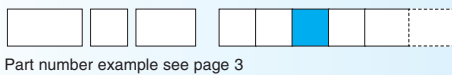

Contacts for plugs, free or fixed sockets

| Reference | Contact type |
|-----------|---------------|
| A | Male solder |
| L | Female solder |

Material and treatment

| Component (see picture page 16) | Material (Standard) | Surface treatment (µm) | | | |
|------------------------------------|------------------------------|------------------------|----|-----|-----|
| | | Cu | Ni | Cr | Au |
| Outer shell and collet nut | Brass (ASTM C 385) | 0.5 | 3 | 0.3 | |
| Earthing crown | Cu-Be (FS-QQ-C-530) | 0.5 | 3 | | 1.5 |
| Latch sleeve | Special brass | 0.5 | 3 | 0.3 | |
| Locking ring | Brass (ASTM C 385) | 0.5 | 3 | | |
| Inner sleeve | Brass (ASTM C 385) | 0.5 | 3 | | |
| Other metallic parts | Brass (ASTM C 385) | 0.5 | 3 | | |
| O-ring | Silicone rubber (ASTM D 200) | | | | |
| Insulator | PTFE (ASTM D 1457-83) | | | | |
| | PEEK (MIL-P-46183) | | | | |
| Male contact | Brass (ASTM C 385) | 0.5 | 3 | | 1.5 |
| Female contact | Cu-Be (FS-QQ-C-530) | 0.5 | 3 | | 2.0 |

The surface treatment standards are as follows:
 - Nickel FS-QQ-N-290A
 - Chrome FS-QQ-C-320B
 - Gold MIL-G-45204C type I, class 1.

MATERIALIEN | MATERIALS
SERIE B+K | SERIES B+K



Part number example see page 3

Housings (B + K series)

| Ref. | Material | Surface treatment | | Note |
|----------|-------------------------------|----------------------------|---------------------------------|------|
| | | Outer shell and collet nut | Latch sleeve and earthing crown | |
| C | Brass | chrome | nickel | ● |
| N | Brass | nickel | nickel | ○ |
| K | Brass | black chrome | nickel | ○ |
| S | Stainless steel | without treatment | nickel-plated brass | ○ |
| T | Stainless steel | without treatment | stainless steel | ○ |
| U | Stainless steel ¹⁾ | without treatment | stainless steel | ○ |
| L | Aluminium alloy ²⁾ | anodized | nickel-plated brass | ○ |
| G | PEEK ³⁾ | without treatment | nickel-plated brass | ○ |
| P | PSU ⁴⁾ | without treatment | nickel-plated brass | ○ |
| R | PPSU ⁵⁾ | without treatment | nickel-plated brass | ○ |
| X | Avional ⁶⁾ | nickel | nickel-plated brass | ○ |

Note:
detailed characteristics of these materials and treatments are presented on Unipole/Multipole catalogue.

¹⁾ the other metallic parts are in stainless steel.
²⁾ the „variant“ position of the reference is used to specify the anodized colour.
³⁾ only available for FGG and ENG models of the B series.
⁴⁾ only available for ENY and FGY models of the B series. For the colour, see the „variant“ position.
⁵⁾ only available for ENY and FGY models of the B series.
⁶⁾ anthracite colour.

● First choice alternative
 ○ Special order alternative



Part number example see page 3

Insulators (B + K series)

| Reference | Material |
|-----------|----------|
| L | PEEK |

Detailed characteristics of these materials are presented on Unipole/Multipole catalogue.



Part number example see page 3

Contacts (B + K series)

Contacts for plugs, free or fixed sockets

| Reference | Contact type |
|-----------|----------------------------------|
| A | Male solder |
| C | Male crimp (fig.1) ¹⁾ |
| B | Male crimp (fig.2) ¹⁾ |
| G | Male crimp (fig.2) ¹⁾ |

| Reference | Contact type |
|-----------|------------------------------------|
| L | Female solder |
| M | Female crimp (fig.1) ¹⁾ |
| P | Female crimp (fig.2) ¹⁾ |
| U | Female crimp (fig.2) ¹⁾ |

Note:
¹⁾ there are two forms of crimp barrels. Please consult adjacent table for contact selection and see Unipole/Multipole catalogue.



MATERIALIEN | MATERIALS
SERIE S+E | SERIES S+E



Housings (S + E series)

| Ref. | Material | Surface treatment | | Note |
|------|-------------------------------|----------------------------|---------------------------------|------|
| | | Outer shell and collet nut | Latch sleeve and earthing crown | |
| C | Brass ¹⁾ | chrome | nickel | ● |
| D | Brass | gold-plated | nickel | ○ |
| N | Brass | nickel | nickel | ○ |
| K | Brass | black chrome | nickel | ○ |
| S | Stainless steel | without treatment | nickel-plated brass | ○ |
| T | Stainless steel | without treatment | stainless steel | ○ |
| U | Stainless steel ²⁾ | without treatment | stainless steel | ○ |
| L | Aluminium alloy ³⁾ | anodized | nickel-plated brass | ○ |
| B | POM black ⁴⁾ | without treatment | nickel-plated brass | ○ |
| G | PEEK ⁴⁾ | without treatment | nickel-plated brass | ○ |
| P | PSU ⁵⁾ | without treatment | nickel-plated brass | ○ |
| R | PPSU ⁶⁾ | without treatment | nickel-plated brass | ○ |

Note:
detailed characteristics of these materials are presented on Unipole/Multipole catalogue.

¹⁾ in the E series the latch sleeve is chrome-plated.

²⁾ the other metallic components are in stainless steel.

³⁾ the „variant“ position of the reference is used to specify the anodized colour.

⁴⁾ only available for FFP, ERN and PCP models of the S series.

⁵⁾ available only for the FFL model of the S series.

⁶⁾ available only for the FFL model of the S series.

● First choice alternative
○ Special order alternative



Insulators (S + E series)

| Reference | Material or form | Note |
|-----------|--------------------|------|
| L | PEEK | ● |
| T | PTFE ¹⁾ | ● |

Note:
detailed characteristics of these materials are presented on Unipole/Multipole catalogue.

¹⁾ only for unipole types.

● First choice alternative ○ Special order alternative



Contacts (S + E series)

Contacts for plugs, free or fixed sockets

| Ref. | Contact type |
|------|-------------------------------|
| A | Male solder |
| C | Male crimp ^{1) 4)} |
| L | Female solder |
| M | Female crimp ^{2) 4)} |

Note:

¹⁾ for the FFS model of the 00 series and FFA or FFL models of the S series.

²⁾ for the PSS model of the 00 series and PCA or PSA models of the S series.

³⁾ for the FTA model of the S series.

⁴⁾ for conductor range that can fit with crimp contacts consult Unipole/ Multipole catalogue.

Contacts for couplers

| Ref. | Contact type | unipole | multipole |
|------|-----------------|---------|-----------|
| A | Male - Female | ○ | — |
| L | Female - Male | ○ | ● |
| M | Female - Female | ● | ○ |

Multipole connectors are fitted with hermaphroditic inserts including male and female contacts. However, by convention, the letter indicating the contact type in the part number composition will be the male contact (reference A) for plugs and female contact (reference A) for sockets. In case of an odd number of contacts, the letter of reference corresponds to the one with the large number of contacts. For example, a 309 type connector with contact (reference A) will include 5 male and 4 female contacts.

For RAD and SWH fixed couplers, the first contact type mentioned is always the one at the flange end.
Connectors can be configured „inverted“ i.e. plugs equipped with female contacts (reference L), sockets with male contacts (reference A). This solution is particularly useful when plugs are mated to a coupler and it is essential to respect contact alignment.

SPANNZANGEN | COLLETS

SERIE Y | SERIES Y



| Reference | | Serie | Ø Collet (mm) | | Ø Cable (mm) | | Part number of the collet ¹⁾ | Lead time |
|-----------|----|-------|---------------|------|--------------|---------------|---|-----------|
| Type | Ø | | Ø A | Ø B | max. | min. | | |
| C | 17 | 1Y | 1.7 | - | 1.6 | 1.3 | FFA.1S.717.CN | ○ |
| C | 22 | | 2.2 | - | 2.1 | 1.7 | FFA.1S.722.CN | ○ |
| C | 27 | | 2.7 | - | 2.6 | 2.2 | FFA.1S.727.CN | ● |
| C | 32 | | 3.2 | - | 3.1 | 2.6 | FFA.1S.732.CN | ● |
| C | 37 | | 3.7 | - | 3.6 | 2.7 | FFA.1S.737.CN | ● |
| C | 42 | | 4.2 | - | 4.1 | 3.3 | FFA.1S.742.CN | ● |
| C | 47 | | 4.7 | - | 4.6 | 3.8 | FFA.1S.747.CN | ● |
| C | 52 | | 5.2 | - | 5.1 | 4.3 | FFA.1S.752.CN | ● |
| C | 57 | | 5.7 | - | 5.6 | 4.8 | FFA.1S.757.CN | ● |
| C | 62 | | 6.2 | 5.2 | 6.1 | 5.3 | FFA.1S.762.CN | ● |
| C | 66 | | 6.6 | 5.5 | 6.5 | 5.9 | FFA.1S.766.CN | ● |
| C | 68 | | 6.8 | 5.5 | 6.7 | 6.0 | FFA.1S.768.CN | ○ |
| C | 42 | 3Y | 4.2 | - | 4.0 | 3.1 | FFA.3S.742.CN | ○ |
| C | 52 | | 5.2 | - | 5.0 | 4.1 | FFA.3S.752.CN | ● |
| C | 57 | | 5.7 | - | 5.5 | 4.6 | FFA.3S.757.CN | ● |
| C | 62 | | 6.2 | - | 6.0 | 5.1 | FFA.3S.762.CN | ● |
| C | 67 | | 6.7 | - | 6.5 | 5.6 | FFA.3S.767.CN | ● |
| C | 72 | | 7.2 | - | 7.0 | 6.1 | FFA.3S.772.CN | ● |
| C | 77 | | 7.7 | - | 7.5 | 6.6 | FFA.3S.777.CN | ● |
| C | 82 | | 8.2 | - | 8.0 | 7.1 | FFA.3S.782.CN | ● |
| C | 87 | | 8.7 | - | 8.5 | 7.6 | FFA.3S.787.CN | ● |
| C | 92 | | 9.2 | 8.7 | 9.0 | 8.1 | FFA.3S.792.CN | ● |
| C | 97 | | 9.7 | 8.7 | 9.5 | 9.1 | FFA.3S.797.CN | ● |
| C | 10 | | 10.2 | 8.7 | 10.0 | 9.6 | FFA.3S.710.CN | ○ |
| C | 11 | 10.7 | 8.7 | 10.5 | 10.1 | FFA.3S.711.CN | ● | |
| C | 12 | 6Y | 12.2 | 12.2 | 12.0 | 11.1 | FFB.6Y.712.CN | ● |
| C | 14 | | 14.2 | 14.2 | 14.0 | 13.1 | FFB.6Y.714.CN | ● |
| C | 21 | | 21.2 | 21.2 | 21.0 | 20.0 | FFB.6Y.721.CN | ● |
| C | 27 | | 26.6 | 23.0 | 26.4 | 25.5 | FFB.6Y.727.CN | ○ |
| C | 29 | | 29.0 | 24.5 | 28.8 | 27.9 | FFB.6Y.729.CN | ○ |
| C | 30 | | 30.2 | 27.2 | 30.0 | 29.1 | FFB.6Y.730.CN | ● |

Note:
¹⁾ for ordering collets separately.

- on stock
- on request



Part number example see page 3



SPANNZANGEN | COLLETS
SERIE B | SERIES B

D and M type collets



| Reference | | Serie | ø Collet (mm) | | ø Cable (mm) | | Part number of the collet ¹⁾ | Part number of the reducer ²⁾ | Part number of the reducing cone ²⁾ | Part number of the collet nut |
|-----------|----|-------|---------------|------|--------------|------|---|--|--|-------------------------------|
| Type | ø | | ø A | ø B | max. | min. | | | | |
| M | 27 | 1B | 2.7 | – | 2.6 | 2.2 | FFC.00.727.CN | FGG.1B.138.LN | FGG.1B.158.LN | FGG.1B.130.LC |
| M | 31 | | 3.1 | – | 3.0 | 2.6 | FFC.00.731.CN | FGG.1B.138.LN | FGG.1B.158.LN | FGG.1B.130.LC |
| D | 42 | | 4.2 | – | 4.0 | 3.1 | FGG.1B.742.DN | – | – | FGG.1B.130.LC |
| D | 52 | | 5.2 | – | 5.0 | 4.1 | FGG.1B.752.DN | – | – | FGG.1B.130.LC |
| D | 62 | | 6.2 | – | 6.0 | 5.1 | FGG.1B.762.DN | – | – | FGG.1B.130.LC |
| D | 72 | | 7.2 | 6.7 | 7.0 | 6.1 | FGG.1B.772.DN | – | – | FGG.1B.130.LC |
| D | 76 | | 7.6 | 6.7 | 7.5 | 7.1 | FGG.1B.776.DN ³⁾ | – | – | FGG.1B.132.LC |
| M | 21 | 2B | 2.1 | – | 2.0 | 1.5 | FGG.0B.721.DN | FGG.2B.138.LN | FGG.2B.158.LN | FGG.2B.130.LC |
| M | 31 | | 3.1 | – | 3.0 | 2.1 | FGG.0B.731.DN | FGG.2B.138.LN | FGG.2B.158.LN | FGG.2B.130.LC |
| M | 42 | | 4.2 | – | 4.0 | 3.1 | FGG.0B.742.DN | FGG.2B.138.LN | FGG.2B.158.LN | FGG.2B.130.LC |
| D | 52 | | 5.2 | – | 5.0 | 4.1 | FGG.2B.752.DN | – | – | FGG.2B.130.LC |
| D | 62 | | 6.2 | – | 6.0 | 5.1 | FGG.2B.762.DN | – | – | FGG.2B.130.LC |
| D | 72 | | 7.2 | – | 7.0 | 6.1 | FGG.2B.772.DN | – | – | FGG.2B.130.LC |
| D | 82 | | 8.2 | – | 8.0 | 7.1 | FGG.2B.782.DN | – | – | FGG.2B.130.LC |
| D | 92 | | 9.2 | 8.6 | 9.0 | 8.1 | FGG.2B.792.DN | – | – | FGG.2B.130.LC |
| D | 99 | | 9.9 | 8.6 | 9.7 | 9.1 | FGG.2B.799.DN ³⁾ | – | – | FGG.2B.132.LC |
| M | 52 | 3B | 5.2 | – | 5.0 | 4.1 | FGG.1B.752.DN | FGG.3B.138.LN | FGG.3B.158.LN | FGG.3B.130.LC |
| D | 62 | | 6.2 | – | 6.0 | 5.1 | FGG.3B.762.DN | – | – | FGG.3B.130.LC |
| D | 72 | | 7.2 | – | 7.0 | 6.1 | FGG.3B.772.DN | – | – | FGG.3B.130.LC |
| D | 82 | | 8.2 | – | 8.0 | 7.1 | FGG.3B.782.DN | – | – | FGG.3B.130.LC |
| D | 92 | | 9.2 | – | 9.0 | 8.1 | FGG.3B.792.DN | – | – | FGG.3B.130.LC |
| D | 10 | | 10.2 | – | 10.0 | 9.1 | FGG.3B.710.DN | – | – | FGG.3B.130.LC |
| D | 11 | | 11.2 | 10.2 | 11.0 | 10.1 | FGG.3B.711.DN | – | – | FGG.3B.130.LC |
| D | 12 | | 11.9 | 10.2 | 11.7 | 11.1 | FGG.3B.712.DN ³⁾ | – | – | FGG.3B.132.LC |

Note:

- ¹⁾ for ordering collets separately.
- ²⁾ for ordering an M type collet, a reducer and its reducing cone should also be ordered.
- ³⁾ these collets cannot be used for connector models with nut for fitting a bend relief.

All dimensions are in millimetres.

SPANNZANGEN | COLLETS
SERIE B | SERIES B



D and M type collets



| Reference | | Serie | ø Collet (mm) | | ø Cable (mm) | | Part number of the collet ¹⁾ | Part number of the reducer ²⁾ | Part number of the reducing cone ²⁾ | Part number of the collet nut |
|-----------|----|-------|---------------|------|--------------|------|---|--|--|-------------------------------|
| Type | ø | | ø A | ø B | max. | min. | | | | |
| M | 62 | 4B | 6.2 | – | 6.0 | 5.1 | FGG.2B.762.DN | FGG.4B.138.LN | FGG.4B.158.LN | FGG.4B.130.LC |
| M | 72 | | 7.2 | – | 7.0 | 6.1 | FGG.2B.772.DN | FGG.4B.138.LN | FGG.4B.158.LN | FGG.4B.130.LC |
| M | 82 | | 8.2 | – | 8.0 | 7.1 | FGG.2B.782.DN | FGG.4B.138.LN | FGG.4B.158.LN | FGG.4B.130.LC |
| M | 92 | | 9.2 | 8.6 | 9.0 | 8.1 | FGG.2B.792.DN | FGG.4B.138.LN | FGG.4B.158.LN | FGG.4B.130.LC |
| D | 10 | | 10.8 | – | 10.5 | 9.1 | FGG.4B.710.DN | – | – | FGG.4B.130.LC |
| D | 12 | | 12.3 | – | 12.0 | 10.6 | FGG.4B.712.DN | – | – | FGG.4B.130.LC |
| D | 13 | | 13.8 | 12.5 | 13.5 | 12.1 | FGG.4B.713.DN | – | – | FGG.4B.130.LC |
| D | 15 | | 15.3 | 12.5 | 15.0 | 13.6 | FGG.4B.715.DN | – | – | FGG.4B.130.LC |
| D | 16 | | 16.3 | 12.5 | 16.0 | 15.1 | FGG.4B.716.DN ³⁾ | – | – | FGG.4B.132.LC |
| D | 11 | 5B | 11.8 | – | 11.5 | 9.6 | FGG.5B.711.DN | – | – | FGG.5B.130.LC |
| D | 13 | | 13.8 | – | 13.5 | 11.6 | FGG.5B.713.DN | – | – | FGG.5B.130.LC |
| D | 15 | | 15.8 | – | 15.5 | 13.6 | FGG.5B.715.DN | – | – | FGG.5B.130.LC |
| D | 17 | | 17.8 | – | 17.5 | 15.6 | FGG.5B.717.DN ³⁾ | – | – | FGG.5B.130.LC |
| D | 19 | | 19.8 | – | 19.5 | 17.6 | FGG.5B.719.DN ³⁾ | – | – | FGG.5B.130.LC |
| D | 21 | | 21.8 | – | 21.5 | 19.6 | FGG.5B.721.DN ³⁾ | – | – | FGG.5B.130.LC |
| D | 23 | | 23.8 | 21.8 | 23.5 | 21.6 | FGG.5B.723.DN ³⁾ | – | – | FGG.5B.130.LC |
| D | 25 | | 25.3 | 21.8 | 25.0 | 23.6 | FGG.5B.725.DN ³⁾ | – | – | FGG.5B.132.LC |

Bend relief collet nut and bend relief

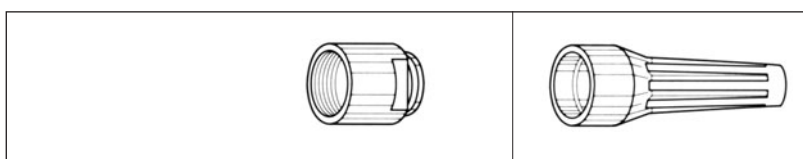

| Reference | | Serie | Part number of the collet nut | Bend relief to be used ¹⁾ |
|-----------|-----------|-------|-------------------------------|--------------------------------------|
| Type | ø | | | |
| M | 27 and 31 | 1B | FFM.1B.130.LC | GMA.1B.***.●● |
| D | 42 to 72 | | FFM.1B.130.LC | GMA.1B.***.●● |
| M | 21 and 31 | 2B | FFM.2B.132.LC | GMA.0B.***.●● |
| M | 42 | | FFM.2B.130.LC | GMA.2B.***.●● |
| D | 52 to 92 | | FFM.2B.130.LC | GMA.2B.***.●● |
| M | 52 | 3B | FFM.3B.131.LC | GMA.1B.***.●● |
| D | 62 to 11 | | FFM.3B.130.LC | GMA.3B.***.●● |
| M | 62 and 72 | 4B | FFM.4B.132.LC | GMA.2B.***.●● |
| M | 82 and 92 | | FFM.4B.130.LC | GMA.4B.***.●● |
| D | 10 to 15 | | FFM.4B.130.LC | GMA.4B.***.●● |
| D | 11 to 15 | 5B | FFM.5B.130.LC | GMA.4B.***.●● |

Note:

- ¹⁾ for ordering collet separately.
- ²⁾ for ordering an M type collet, a reducer and its reducing cone should also be ordered.
- ³⁾ these collets cannot be used for connector models with collet nut for fitting a bend relief.

Note:

¹⁾ the bend relief is to be ordered separately (see page 80). All dimensions are in millimetres.



Part number example see page 3

SPANNZANGEN | COLLETS
SERIE K | SERIES K



C + K type collets



| Reference | | Serie | ø Collet (mm) | | ø Cable (mm) | | Part number of the collet system ¹⁾ | Part number of the oversize collet and of the two split centre-pieces ²⁾ | Part number of the collet nut ²⁾ |
|-----------|----|-------|---------------|------|--------------|------|--|---|---|
| Type | ø | | ø A | ø B | max. | min. | | | |
| C | 15 | 1K | 1.6 | – | 1.5 | 1.3 | FFA.1E.715.CNS | – | FFA.1E.130.LC |
| C | 20 | | 2.2 | – | 2.0 | 1.6 | FFA.1E.720.CNS | – | FFA.1E.130.LC |
| C | 25 | | 3.2 | – | 2.5 | 2.1 | FFA.1E.725.CNS | – | FFA.1E.130.LC |
| C | 30 | | 3.2 | – | 3.0 | 2.6 | FFA.1E.730.CNS | – | FFA.1E.130.LC |
| C | 35 | | 4.2 | – | 3.5 | 3.1 | FFA.1E.735.CNS | – | FFA.1E.130.LC |
| C | 40 | | 4.2 | – | 4.0 | 3.6 | FFA.1E.740.CNS | – | FFA.1E.130.LC |
| C | 45 | | 5.2 | – | 4.5 | 4.1 | FFA.1E.745.CNS | – | FFA.1E.130.LC |
| C | 50 | | 5.2 | – | 5.0 | 4.6 | FFA.1E.750.CNS | – | FFA.1E.130.LC |
| C | 55 | | 6.2 | 6.2 | 5.5 | 5.1 | FFA.1E.755.CNS | – | FFA.1E.130.LC |
| C | 60 | | 6.2 | 6.2 | 6.0 | 5.6 | FFA.1E.760.CNS | – | FFA.1E.130.LC |
| C | 65 | | 7.2 | 6.7 | 6.5 | 6.1 | FFA.1E.765.CNS | – | FFA.1E.130.LC |
| K | 70 | | 7.2 | – | 7.0 | 6.6 | FFA.2E.770.CNS | FFA.1K.137.LCN | FFA.2E.130.LC ²⁾ |
| K | 75 | | 8.2 | 8.2 | 7.5 | 7.1 | FFA.2E.775.CNS | FFA.1K.137.LCN | FFA.2E.130.LC ²⁾ |
| K | 80 | | 8.2 | 8.2 | 8.0 | 7.6 | FFA.2E.780.CNS | FFA.1K.137.LCN | FFA.2E.130.LC ²⁾ |
| K | 85 | | 9.2 | 8.6 | 8.5 | 8.1 | FFA.2E.785.CNS | FFA.1K.137.LCN | FFA.2E.130.LC ²⁾ |
| C | 15 | | 2K | 2.2 | – | 1.5 | 1.3 | FFA.2E.715.CNS | – |
| C | 20 | 2.2 | | – | 2.0 | 1.6 | FFA.2E.720.CNS | – | FFA.2E.130.LC |
| C | 25 | 3.2 | | – | 2.5 | 2.1 | FFA.2E.725.CNS | – | FFA.2E.130.LC |
| C | 30 | 3.2 | | – | 3.0 | 2.6 | FFA.2E.730.CNS | – | FFA.2E.130.LC |
| C | 35 | 4.2 | | – | 3.5 | 3.1 | FFA.2E.735.CNS | – | FFA.2E.130.LC |
| C | 40 | 4.2 | | – | 4.0 | 3.6 | FFA.2E.740.CNS | – | FFA.2E.130.LC |
| C | 45 | 5.2 | | – | 4.5 | 4.1 | FFA.2E.745.CNS | – | FFA.2E.130.LC |
| C | 50 | 5.2 | | – | 5.0 | 4.6 | FFA.2E.750.CNS | – | FFA.2E.130.LC |
| C | 55 | 6.2 | | – | 5.5 | 5.1 | FFA.2E.755.CNS | – | FFA.2E.130.LC |
| C | 60 | 6.2 | | – | 6.0 | 5.6 | FFA.2E.760.CNS | – | FFA.2E.130.LC |
| C | 65 | 7.2 | | – | 6.5 | 6.1 | FFA.2E.765.CNS | – | FFA.2E.130.LC |
| C | 70 | 7.2 | | – | 7.0 | 6.6 | FFA.2E.770.CNS | – | FFA.2E.130.LC |
| C | 75 | 8.2 | | 8.2 | 7.5 | 7.1 | FFA.2E.775.CNS | – | FFA.2E.130.LC |
| C | 80 | 8.2 | | 8.2 | 8.0 | 7.6 | FFA.2E.780.CNS | – | FFA.2E.130.LC |
| C | 85 | 9.2 | | 8.6 | 8.5 | 8.1 | FFA.2E.785.CNS | – | FFA.2E.130.LC |
| K | 90 | 9.2 | | – | 9.0 | 8.6 | FFA.3E.790.CNS | FFA.2K.137.LCN | FFA.3E.130.LC ²⁾ |
| K | 95 | 10.2 | | 10.2 | 9.5 | 9.1 | FFA.3E.795.CNS | FFA.2K.137.LCN | FFA.3E.130.LC ²⁾ |
| K | 10 | 10.2 | | 10.2 | 10.0 | 9.6 | FFA.3E.710.CNS | FFA.2K.137.LCN | FFA.3E.130.LC ²⁾ |
| K | 11 | 11.2 | | 10.6 | 11.0 | 10.1 | FFA.3E.711.CNS | FFA.2K.137.LCN | FFA.3E.130.LC ²⁾ |

Note:

¹⁾ for ordering the collet system separately.

²⁾ for ordering the K type collet, the oversize collet and the split centre-pieces, as well as the corresponding collet nut should also be ordered.
All dimensions are in millimetres.

SPANNZANGEN COLLETS

SERIE K SERIES K



C + K type collets

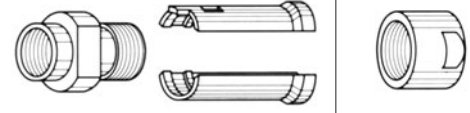

| Reference | | Serie | ø Collet (mm) | | ø Cable (mm) | | Part number of the collet system ¹⁾ | Part number of the oversize collet and of the two split centre-pieces ²⁾ | Part number of the collet nut ²⁾ |
|-----------|----|-------|---------------|------|--------------|----------------|--|---|---|
| Type | ø | | ø A | ø B | max. | min. | | | |
| C | 30 | 3K | 3.2 | - | 3.0 | 2.6 | FFA.3E.730.CNS | - | FFA.3E.130.LC |
| C | 35 | | 4.2 | - | 3.5 | 3.1 | FFA.3E.735.CNS | - | FFA.3E.130.LC |
| C | 40 | | 4.2 | - | 4.0 | 3.6 | FFA.3E.740.CNS | - | FFA.3E.130.LC |
| C | 45 | | 5.2 | - | 4.5 | 4.1 | FFA.3E.745.CNS | - | FFA.3E.130.LC |
| C | 50 | | 5.2 | - | 5.0 | 4.6 | FFA.3E.750.CNS | - | FFA.3E.130.LC |
| C | 55 | | 6.2 | - | 5.5 | 5.1 | FFA.3E.755.CNS | - | FFA.3E.130.LC |
| C | 60 | | 6.2 | - | 6.0 | 5.6 | FFA.3E.760.CNS | - | FFA.3E.130.LC |
| C | 65 | | 7.2 | - | 6.5 | 6.1 | FFA.3E.765.CNS | - | FFA.3E.130.LC |
| C | 70 | | 7.2 | - | 7.0 | 6.6 | FFA.3E.770.CNS | - | FFA.3E.130.LC |
| C | 75 | | 8.2 | - | 7.5 | 7.1 | FFA.3E.775.CNS | - | FFA.3E.130.LC |
| C | 80 | | 8.2 | - | 8.0 | 7.6 | FFA.3E.780.CNS | - | FFA.3E.130.LC |
| C | 85 | | 9.2 | - | 8.5 | 8.1 | FFA.3E.785.CNS | - | FFA.3E.130.LC |
| C | 90 | | 9.2 | - | 9.0 | 8.6 | FFA.3E.790.CNS | - | FFA.3E.130.LC |
| C | 95 | | 10.2 | 10.2 | 9.5 | 9.1 | FFA.3E.795.CNS | - | FFA.3E.130.LC |
| C | 10 | | 10.2 | 10.2 | 10.0 | 9.6 | FFA.3E.710.CNS | - | FFA.3E.130.LC |
| C | 11 | | 11.2 | 11.2 | 10.5 | 10.1 | FFA.3E.711.CNS | - | FFA.3E.130.LC |
| K | 11 | | 12.3 | - | 12.0 | 10.6 | FFA.4E.711.CNS | FFA.3K.137.LCN | FFA.4E.130.LC ²⁾ |
| K | 12 | | 13.8 | 13.8 | 12.8 | 12.1 | FFA.4E.712.CNS | FFA.3K.137.LCN | FFA.4E.130.LC ²⁾ |
| K | 13 | | 13.8 | 13.8 | 13.5 | 12.9 | FFA.4E.713.CNS | FFA.3K.137.LCN | FFA.4E.130.LC ²⁾ |
| K | 14 | | 15.3 | 15.3 | 14.0 | 13.6 | FFA.4E.714.CNS | FFA.3K.137.LCN | FFA.4E.130.LC ²⁾ |
| K | 15 | 15.3 | 15.3 | 15.0 | 14.1 | FFA.4E.715.CNS | FFA.3K.137.LCN | FFA.4E.130.LC ²⁾ | |
| C | 50 | 4K | 6.3 | - | 5.0 | 4.8 | FFA.4E.750.CNS | - | FFA.4E.130.LC |
| C | 55 | | 6.3 | - | 5.5 | 5.1 | FFA.4E.755.CNS | - | FFA.4E.130.LC |
| C | 60 | | 6.3 | - | 6.0 | 5.6 | FFA.4E.760.CNS | - | FFA.4E.130.LC |
| C | 65 | | 7.3 | - | 6.5 | 6.1 | FFA.4E.765.CNS | - | FFA.4E.130.LC |
| C | 70 | | 7.3 | - | 7.0 | 6.6 | FFA.4E.770.CNS | - | FFA.4E.130.LC |
| C | 75 | | 8.3 | - | 7.5 | 7.1 | FFA.4E.775.CNS | - | FFA.4E.130.LC |
| C | 80 | | 8.3 | - | 8.0 | 7.6 | FFA.4E.780.CNS | - | FFA.4E.130.LC |
| C | 85 | | 9.3 | - | 8.5 | 8.1 | FFA.4E.785.CNS | - | FFA.4E.130.LC |
| C | 90 | | 9.3 | - | 9.0 | 8.6 | FFA.4E.790.CNS | - | FFA.4E.130.LC |
| C | 95 | | 10.8 | - | 9.5 | 9.1 | FFA.4E.795.CNS | - | FFA.4E.130.LC |
| C | 10 | | 10.8 | - | 10.5 | 9.6 | FFA.4E.710.CNS | - | FFA.4E.130.LC |
| C | 11 | | 12.3 | - | 12.0 | 10.6 | FFA.4E.711.CNS | - | FFA.4E.130.LC |
| C | 12 | | 13.8 | 13.8 | 12.8 | 12.1 | FFA.4E.712.CNS | - | FFA.4E.130.LC |
| C | 13 | | 13.8 | 13.8 | 13.5 | 12.9 | FFA.4E.713.CNS | - | FFA.4E.130.LC |
| C | 14 | | 15.3 | 15.3 | 14.0 | 13.6 | FFA.4E.714.CNS | - | FFA.4E.130.LC |
| C | 15 | | 15.3 | 15.3 | 15.0 | 14.1 | FFA.4E.715.CNS | - | FFA.4E.130.LC |
| K | 16 | | 17.8 | - | 16.5 | 15.6 | FFA.4K.716.CNS | FFA.4K.137.LCN ³⁾ | FFA.4K.136.LC ²⁾ |
| K | 17 | | 17.8 | - | 17.5 | 16.6 | FFA.4K.717.CNS | FFA.4K.137.LCN | FFA.4K.136.LC ²⁾ |
| K | 18 | | 19.8 | - | 18.5 | 17.6 | FFA.4K.718.CNS | FFA.4K.137.LCN | FFA.4K.136.LC ²⁾ |
| K | 19 | | 19.8 | - | 19.5 | 18.6 | FFA.4K.719.CNS | FFA.4K.137.LCN | FFA.4K.136.LC ²⁾ |
| K | 20 | | 21.8 | - | 20.5 | 19.6 | FFA.4K.720.CNS | FFA.4K.137.LCN | FFA.4K.136.LC ²⁾ |
| K | 21 | | 21.8 | - | 21.5 | 20.6 | FFA.4K.721.CNS | FFA.4K.137.LCN | FFA.4K.136.LC ²⁾ |
| K | 22 | | 23.8 | 23.8 | 22.5 | 21.6 | FFA.4K.722.CNS | FFA.4K.137.LCN | FFA.4K.136.LC ²⁾ |
| K | 23 | | 23.8 | 23.8 | 23.5 | 22.6 | FFA.4K.723.CNS | FFA.4K.137.LCN | FFA.4K.136.LC ²⁾ |

Note: ¹⁾ for ordering the collet system separately.
²⁾ for ordering the K type collet, the oversize collet and the split centre-pieces, as well as the corresponding collet nut should also be ordered.

³⁾ in 4K series, the centre-piece is made of one piece.

All dimensions are in millimetres.



Part number example see page 3



SPANNZANGEN | COLLETS
SERIE K | SERIES K

C type collets



| Reference | | Serie | ø Collet (mm) | | ø Cable (mm) | | Part number of the collet system ¹⁾ | Part number of the collet nut |
|-----------|----|-------|---------------|------|--------------|------|--|-------------------------------|
| Type | ø | | ø A | ø B | max. | min. | | |
| C | 10 | 5K | 11.8 | – | 10.5 | 9.6 | FFA.5K.710.CNS | FFA.5K.130.LC |
| C | 11 | | 11.8 | – | 11.5 | 10.6 | FFA.5K.711.CNS | FFA.5K.130.LC |
| C | 12 | | 13.8 | – | 12.5 | 11.6 | FFA.5K.712.CNS | FFA.5K.130.LC |
| C | 13 | | 13.8 | – | 13.5 | 12.6 | FFA.5K.713.CNS | FFA.5K.130.LC |
| C | 14 | | 15.8 | – | 14.5 | 13.6 | FFA.5K.714.CNS | FFA.5K.130.LC |
| C | 15 | | 15.8 | – | 15.5 | 14.6 | FFA.5K.715.CNS | FFA.5K.130.LC |
| C | 16 | | 17.8 | – | 16.5 | 15.6 | FFA.5K.716.CNS | FFA.5K.130.LC |
| C | 17 | | 17.8 | – | 17.5 | 16.6 | FFA.5K.717.CNS | FFA.5K.130.LC |
| C | 18 | | 19.8 | – | 18.5 | 17.6 | FFA.5K.718.CNS | FFA.5K.130.LC |
| C | 19 | | 19.8 | – | 19.5 | 18.6 | FFA.5K.719.CNS | FFA.5K.130.LC |
| C | 20 | | 21.8 | – | 20.5 | 19.6 | FFA.5K.720.CNS | FFA.5K.130.LC |
| C | 21 | | 21.8 | – | 21.5 | 20.6 | FFA.5K.721.CNS | FFA.5K.130.LC |
| C | 22 | | 23.8 | 23.8 | 22.5 | 21.6 | FFA.5K.722.CNS | FFA.5K.130.LC |
| C | 23 | | 23.8 | 23.8 | 23.5 | 22.6 | FFA.5K.723.CNS | FFA.5K.130.LC |

Note:

¹⁾ for ordering the collet system separately.

Bend relief collet nut and bend relief

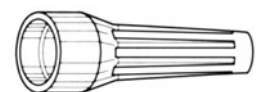
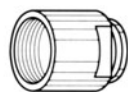

| Reference | | Serie | Part number of the collet nut | Bend relief to be used ¹⁾ |
|-----------|----------|-------|-------------------------------|--------------------------------------|
| Type | ø | | | |
| C | 15 to 65 | 1K | FFM.1E.130.LC | GMA.1B.***.●● |
| K | 70 to 85 | | FFM.2E.130.LC | GMA.2B.***.●● |
| C | 15 to 85 | 2K | FFM.2E.130.LC | GMA.2B.***.●● |
| K | 90 to 11 | | FFM.3E.130.LC | GMA.3B.***.●● |
| C | 30 to 10 | 3K | FFM.3E.130.LC | GMA.3B.***.●● |
| K | 11 to 15 | | FFM.4E.130.LC | GMA.4B.***.●● |
| C | 50 to 15 | 4K | FFM.4E.130.LC | GMA.4B.***.●● |

Note:

¹⁾ the bend relief is to be ordered separately (see page 80).
All dimensions are in millimetres.

SPANNZANGEN COLLETS

SERIE S SERIES S



C, K and L type collets



C or K type collets



L type collet

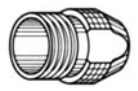

| Reference | | Serie | ø Collet (mm) | | ø Cable (mm) | | Part number of the collet ¹⁾ | Part number of the oversize collet and of the split centre-pieces ³⁾ | Part number of the collet nut ^{3) 5)} |
|-----------|----|-------|---------------|-----|--------------|---------------|---|---|--|
| Type | ø | | ø A | ø B | max. | min. | | | |
| C | 17 | OS | 1.7 | – | 1.6 | 1.3 | FFA.0S.717.CN | – | FFA.0S.130.LC |
| C | 22 | | 2.2 | – | 2.1 | 1.7 | FFA.0S.722.CN | – | FFA.0S.130.LC |
| C | 27 | | 2.7 | – | 2.6 | 2.2 | FFA.0S.727.CN | – | FFA.0S.130.LC |
| C | 32 | | 3.2 | – | 3.1 | 2.7 | FFA.0S.732.CN | – | FFA.0S.130.LC |
| C | 37 | | 3.7 | – | 3.6 | 3.0 | FFA.0S.737.CN | – | FFA.0S.130.LC |
| C | 42 | | 4.2 | 3.7 | 4.1 | 3.3 | FFA.0S.742.CN | – | FFA.0S.130.LC |
| C | 44 | | 4.4 | 3.7 | 4.3 | 3.5 | FFA.0S.744.CN | – | FFA.0S.132.LC |
| K | 47 | | 4.7 | – | 4.6 | 3.8 | FFA.1S.747.CN | FFA.0S.137.LCN | FFA.1S.130.LC |
| K | 52 | | 5.2 | – | 5.1 | 4.3 | FFA.1S.752.CN | FFA.0S.137.LCN | FFA.1S.130.LC |
| K | 57 | | 5.7 | – | 5.6 | 4.8 | FFA.1S.757.CN | FFA.0S.137.LCN | FFA.1S.130.LC |
| K | 62 | | 6.2 | 5.2 | 6.1 | 5.3 | FFA.1S.762.CN | FFA.0S.137.LCN | FFA.1S.130.LC |
| K | 66 | | 6.6 | 5.4 | 6.5 | 5.9 | FFA.1S.766.CN | FFA.0S.137.LCN | FFA.1S.131.LC |
| K | 68 | | 6.8 | – | 6.7 | 6.0 | FFA.1S.768.CN | FFA.0S.137.LCN | FFA.1S.131.LC |
| C | 17 | | 1.7 | – | 1.6 | 1.3 | FLA.0S.717.CN ⁴⁾ | – | FFA.0S.130.LC |
| C | 22 | | 2.2 | – | 2.1 | 1.7 | FLA.0S.722.CN ⁴⁾ | – | FFA.0S.130.LC |
| C | 27 | | 2.7 | – | 2.6 | 2.2 | FLA.0S.727.CN ⁴⁾ | – | FFA.0S.130.LC |
| C | 32 | | 3.2 | – | 3.1 | 2.7 | FLA.0S.732.CN ⁴⁾ | – | FFA.0S.130.LC |
| C | 37 | | 3.7 | – | 3.6 | 3.0 | FLA.0S.737.CN ⁴⁾ | – | FFA.0S.130.LC |
| C | 42 | | 4.2 | 3.7 | 4.1 | 3.3 | FLA.0S.742.CN ⁴⁾ | – | FFA.0S.130.LC |
| C | 44 | | 4.4 | 3.7 | 4.3 | 3.5 | FLA.0S.744.CN ⁴⁾ | – | FFA.0S.132.LC |
| L | 17 | 1.7 | – | 1.6 | 1.3 | FFA.0S.717.LN | – | FFA.0S.130.LC | |
| L | 22 | 2.2 | – | 2.1 | 1.7 | FFA.0S.722.LN | – | FFA.0S.130.LC | |
| L | 27 | 2.7 | – | 2.6 | 2.2 | FFA.0S.727.LN | – | FFA.0S.130.LC | |
| L | 32 | 3.2 | – | 3.1 | 2.7 | FFA.0S.732.LN | – | FFA.0S.130.LC | |
| L | 37 | 3.7 | – | 3.6 | 3.0 | FFA.0S.737.LN | – | FFA.0S.130.LC | |
| L | 42 | 4.2 | – | 4.1 | 3.3 | FFA.0S.742.LN | – | FFA.0S.130.LC | |
| L | 44 | 4.4 | – | 4.3 | 3.5 | FFA.0S.744.LN | – | FFA.0S.132.LC | |

Note: see following page for text of notes ¹⁾ through ⁵⁾.
All dimensions are in millimetres.



Part number example see page 3



SPANNZANGEN | COLLETS
SERIE S | SERIES S

C, K and L type collets



C or K type collets



L type collet



| Reference | | Serie | ø Collet (mm) | | ø Cable (mm) | | Part number of the collet ¹⁾ | Part number of the oversize collet and of the split centre-pieces ³⁾ | Part number of the collet nut ^{3) 5)} |
|-----------|----|-------|---------------|-----|--------------|-----------------------------|---|---|--|
| Type | ø | | ø A | ø B | max. | min. | | | |
| C | 17 | 1S | 1.7 | – | 1.6 | 1.3 | FFA.1S.717.CN | – | FFA.1S.130.LC |
| C | 22 | | 2.2 | – | 2.1 | 1.7 | FFA.1S.722.CN | – | FFA.1S.130.LC |
| C | 27 | | 2.7 | – | 2.6 | 2.2 | FFA.1S.727.CN | – | FFA.1S.130.LC |
| C | 32 | | 3.2 | – | 3.1 | 2.6 | FFA.1S.732.CN | – | FFA.1S.130.LC |
| C | 37 | | 3.7 | – | 3.6 | 2.7 | FFA.1S.737.CN | – | FFA.1S.130.LC |
| C | 42 | | 4.2 | – | 4.1 | 3.3 | FFA.1S.742.CN | – | FFA.1S.130.LC |
| C | 47 | | 4.7 | – | 4.6 | 3.8 | FFA.1S.747.CN | – | FFA.1S.130.LC |
| C | 52 | | 5.2 | – | 5.1 | 4.3 | FFA.1S.752.CN | – | FFA.1S.130.LC |
| C | 57 | | 5.7 | – | 5.6 | 4.8 | FFA.1S.757.CN | – | FFA.1S.130.LC |
| C | 62 | | 6.2 | 5.2 | 6.1 | 5.3 | FFA.1S.762.CN | – | FFA.1S.130.LC |
| C | 66 | | 6.6 | 5.4 | 6.5 | 5.9 | FFA.1S.766.CN | – | FFA.1S.131.LC |
| C | 68 | | 6.8 | – | 6.7 | 6.0 | FFA.1S.768.CN | – | FFA.1S.131.LC |
| K | 72 | | 7.2 | 6.7 | 7.0 | 6.1 | FFA.2S.772.CN | FFA.1S.137.LCN | FFA.2S.130.LC |
| K | 77 | | 7.7 | 6.7 | 7.5 | 7.1 | FFA.2S.777.CN | FFA.1S.137.LCN | FFA.2S.130.LC |
| K | 82 | | 8.2 | 6.7 | 8.0 | 7.6 | FFA.2S.782.CN | FFA.1S.137.LCN | FFA.2S.130.LC |
| K | 87 | | 8.7 | 6.7 | 8.5 | 8.1 | FFA.2S.787.CN | FFA.1S.137.LCN | FFA.2S.130.LC |
| C | 17 | | 1.7 | – | 1.6 | 1.3 | FLA.1S.717.CN ⁴⁾ | – | FFA.1S.130.LC |
| C | 22 | | 2.2 | – | 2.1 | 1.7 | FLA.1S.722.CN ⁴⁾ | – | FFA.1S.130.LC |
| C | 27 | | 2.7 | – | 2.6 | 2.2 | FLA.1S.727.CN ⁴⁾ | – | FFA.1S.130.LC |
| C | 32 | | 3.2 | – | 3.1 | 2.6 | FLA.1S.732.CN ⁴⁾ | – | FFA.1S.130.LC |
| C | 37 | | 3.7 | – | 3.6 | 2.7 | FLA.1S.737.CN ⁴⁾ | – | FFA.1S.130.LC |
| C | 42 | | 4.2 | – | 4.1 | 3.3 | FLA.1S.742.CN ⁴⁾ | – | FFA.1S.130.LC |
| C | 47 | | 4.7 | – | 4.6 | 3.8 | FLA.1S.747.CN ⁴⁾ | – | FFA.1S.130.LC |
| C | 52 | | 5.2 | – | 5.1 | 4.3 | FLA.1S.752.CN ⁴⁾ | – | FFA.1S.130.LC |
| C | 57 | | 5.7 | – | 5.6 | 4.8 | FLA.1S.757.CN ⁴⁾ | – | FFA.1S.130.LC |
| C | 62 | | 6.2 | 5.2 | 6.1 | 5.3 | FLA.1S.762.CN ⁴⁾ | – | FFA.1S.130.LC |
| C | 66 | 6.6 | 5.4 | 6.5 | 5.9 | FLA.1S.766.CN ⁴⁾ | – | FFA.1S.131.LC | |
| C | 68 | 6.8 | 5.5 | 6.7 | 6.0 | FLA.1S.768.CN ⁴⁾ | – | FFA.1S.131.LC | |
| L | 17 | 1.7 | – | 1.6 | 1.3 | FFA.1S.717.LN | – | FFA.1S.130.LC | |
| L | 22 | 2.2 | – | 2.1 | 1.7 | FFA.1S.722.LN | – | FFA.1S.130.LC | |
| L | 27 | 2.7 | – | 2.6 | 2.2 | FFA.1S.727.LN | – | FFA.1S.130.LC | |
| L | 32 | 3.2 | – | 3.1 | 2.6 | FFA.1S.732.LN | – | FFA.1S.130.LC | |
| L | 37 | 3.7 | – | 3.6 | 2.7 | FFA.1S.737.LN | – | FFA.1S.130.LC | |
| L | 42 | 4.2 | – | 4.1 | 3.3 | FFA.1S.742.LN | – | FFA.1S.130.LC | |
| L | 47 | 4.7 | – | 4.6 | 3.8 | FFA.1S.747.LN | – | FFA.1S.130.LC | |
| L | 50 | 5.0 | – | 4.9 | 4.7 | FFA.1S.750.LN | – | FFA.1S.130.LC | |
| L | 52 | 5.2 | – | 5.1 | 4.3 | FFA.1S.752.LN | – | FFA.1S.130.LC | |
| L | 57 | 5.7 | – | 5.6 | 4.8 | FFA.1S.757.LN | – | FFA.1S.130.LC | |
| L | 62 | 6.2 | – | 6.1 | 5.3 | FFA.1S.762.LN | – | FFA.1S.130.LC | |
| L | 66 | 6.6 | – | 6.5 | 5.9 | FFA.1S.766.LN | – | FFA.1S.131.LC | |

Note:

- ¹⁾ for ordering collets separately.
- ²⁾ these collets can only be used with the FLA model.
- ³⁾ for ordering a K type collet separately, the oversize collet and the corresponding collet nut should also be ordered.
- ⁴⁾ these collets should be used with FLA, FFP and PCP models.
- ⁵⁾ for models with bend relief, the FFM.●●.130.LC collet nut should be ordered (see page 76).

All dimensions are in millimetres.

SPANNZANGEN COLLETS
SERIE S | SERIES S

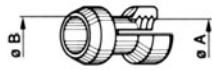
C, K and L type collets

C or K type collets



L type collet

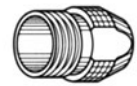

| Reference | | Serie | ø Collet (mm) | | ø Cable (mm) | | Part number of the collet ¹⁾ | Part number of the oversize collet and of the split centre-pieces ³⁾ | Part number of the collet nut ^{3) 5)} |
|-----------|----|-------|---------------|-----|--------------|---------------|---|---|--|
| Type | ø | | ø A | ø B | max. | min. | | | |
| C | 17 | 2S | 1.7 | - | 1.6 | 1.3 | FFA.2S.717.CN | - | FFA.2S.130.LC |
| C | 27 | | 2.7 | - | 2.5 | 1.7 | FFA.2S.727.CN | - | FFA.2S.130.LC |
| C | 32 | | 3.2 | - | 3.0 | 2.5 | FFA.2S.732.CN | - | FFA.2S.130.LC |
| C | 42 | | 4.2 | - | 4.0 | 3.1 | FFA.2S.742.CN | - | FFA.2S.130.LC |
| C | 52 | | 5.2 | - | 5.0 | 4.1 | FFA.2S.752.CN | - | FFA.2S.130.LC |
| C | 62 | | 6.2 | - | 6.0 | 5.1 | FFA.2S.762.CN | - | FFA.2S.130.LC |
| C | 72 | | 7.2 | 6.7 | 7.0 | 6.1 | FFA.2S.772.CN | - | FFA.2S.130.LC |
| C | 77 | | 7.7 | 6.7 | 7.5 | 7.1 | FFA.2S.777.CN | - | FFA.2S.130.LC |
| C | 82 | | 8.2 | 6.7 | 8.0 | 7.6 | FFA.2S.782.CN | - | FFA.2S.130.LC |
| C | 87 | | 8.7 | 6.7 | 8.5 | 8.1 | FFA.2S.787.CN | - | FFA.2S.130.LC |
| K | 92 | | 9.2 | 8.7 | 9.0 | 8.1 | FFA.3S.792.CN | FFA.2S.137.LCN | FFA.3S.130.LC |
| K | 97 | | 9.7 | 8.7 | 9.5 | 9.1 | FFA.3S.797.CN | FFA.2S.137.LCN | FFA.3S.130.LC |
| K | 10 | | 10.2 | 8.7 | 10.0 | 9.6 | FFA.3S.710.CN | FFA.2S.137.LCN | FFA.3S.130.LC |
| K | 11 | | 10.7 | 9.0 | 10.5 | 10.1 | FFA.3S.711.CN | FFA.2S.137.LCN | FFA.3S.130.LC |
| C | 17 | | 1.7 | - | 1.6 | 1.3 | FLA.2S.717.CN ⁴⁾ | - | FFA.2S.130.LC |
| C | 27 | | 2.7 | - | 2.5 | 1.7 | FLA.2S.727.CN ⁴⁾ | - | FFA.2S.130.LC |
| C | 32 | | 3.2 | - | 3.0 | 2.5 | FLA.2S.732.CN ⁴⁾ | - | FFA.2S.130.LC |
| C | 42 | | 4.2 | - | 4.0 | 3.1 | FLA.2S.742.CN ⁴⁾ | - | FFA.2S.130.LC |
| C | 52 | | 5.2 | - | 5.0 | 4.1 | FLA.2S.752.CN ⁴⁾ | - | FFA.2S.130.LC |
| C | 62 | | 6.2 | - | 6.0 | 5.1 | FLA.2S.762.CN ⁴⁾ | - | FFA.2S.130.LC |
| C | 72 | | 7.2 | 6.7 | 7.0 | 6.1 | FLA.2S.772.CN ⁴⁾ | - | FFA.2S.130.LC |
| C | 77 | | 7.7 | 6.7 | 7.5 | 7.1 | FLA.2S.777.CN ⁴⁾ | - | FFA.2S.130.LC |
| C | 82 | | 8.2 | 6.7 | 8.0 | 7.6 | FLA.2S.782.CN ⁴⁾ | - | FFA.2S.130.LC |
| C | 87 | | 8.7 | 6.7 | 8.5 | 8.1 | FLA.2S.787.CN ⁴⁾ | - | FFA.2S.130.LC |
| L | 27 | | 2.7 | - | 2.5 | 1.7 | FFA.2S.727.LN | - | FFA.2S.130.LC |
| L | 32 | | 3.2 | - | 3.0 | 2.5 | FFA.2S.732.LN | - | FFA.2S.130.LC |
| L | 42 | | 4.2 | - | 4.0 | 3.1 | FFA.2S.742.LN | - | FFA.2S.130.LC |
| L | 52 | | 5.2 | - | 5.0 | 4.1 | FFA.2S.752.LN | - | FFA.2S.130.LC |
| L | 62 | | 6.2 | - | 6.0 | 5.1 | FFA.2S.762.LN | - | FFA.2S.130.LC |
| L | 72 | | 7.2 | - | 7.0 | 6.1 | FFA.2S.772.LN | - | FFA.2S.130.LC |
| L | 77 | | 7.9 | - | 7.5 | 7.1 | FFA.2S.777.LN | - | FFA.2S.130.LC |
| L | 82 | | 8.2 | - | 8.0 | 7.6 | FFA.2S.782.LN | - | FFA.2S.130.LC |
| L | 87 | 8.7 | - | 8.5 | 8.1 | FFA.2S.787.LN | - | FFA.2S.130.LC | |

Note:
¹⁾ for ordering collets separately.

³⁾ for ordering a K type collet separately, the oversize collet and the corresponding collet nut should also be ordered.

⁴⁾ these collets should be used with FLA, FFP and PCP models.

⁵⁾ for models with bend relief, the FFM.●●.130.LC collet nut should be ordered (see page 76).

All dimensions are in millimetres.



Part number example see page 3



SPANNZANGEN | COLLETS
SERIE S | SERIES S

C, K and L type collets

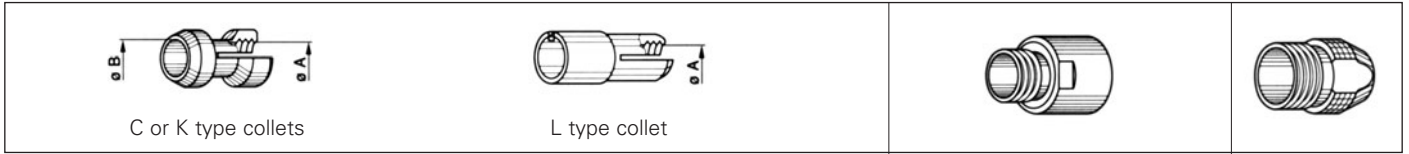

| Reference | | Serie | ø Collet (mm) | | ø Cable (mm) | | Part number of the collet ¹⁾ | Part number of the oversize collet and of the split centre-pieces ³⁾ | Part number of the collet nut ^{3) 5)} |
|-----------|----|-------|---------------|------|--------------|---------------|---|---|--|
| Type | ø | | ø A | ø B | max. | min. | | | |
| C | 32 | 3S | 3.2 | – | 3.0 | 2.5 | FFA.3S.732.CN | – | FFA.3S.130.LC |
| C | 42 | | 4.2 | – | 4.0 | 3.1 | FFA.3S.742.CN | – | FFA.3S.130.LC |
| C | 52 | | 5.2 | – | 5.0 | 4.1 | FFA.3S.752.CN | – | FFA.3S.130.LC |
| C | 62 | | 6.2 | – | 6.0 | 5.1 | FFA.3S.762.CN | – | FFA.3S.130.LC |
| C | 72 | | 7.2 | – | 7.0 | 6.1 | FFA.3S.772.CN | – | FFA.3S.130.LC |
| C | 82 | | 8.2 | – | 8.0 | 7.1 | FFA.3S.782.CN | – | FFA.3S.130.LC |
| C | 92 | | 9.2 | 8.7 | 9.0 | 8.1 | FFA.3S.792.CN | – | FFA.3S.130.LC |
| C | 97 | | 9.7 | 8.7 | 9.5 | 9.1 | FFA.3S.797.CN | – | FFA.3S.130.LC |
| C | 10 | | 10.2 | 8.7 | 10.0 | 9.6 | FFA.3S.710.CN | – | FFA.3S.130.LC |
| C | 11 | | 10.7 | 9.0 | 10.5 | 10.1 | FFA.3S.711.CN | – | FFA.3S.130.LC |
| K | 12 | | 12.2 | – | 12.0 | 11.1 | FFA.4S.712.CN | FFA.3S.137.LCN | FFA.4S.130.LC |
| K | 13 | | 13.2 | 12.2 | 13.0 | 12.1 | FFA.4S.713.CN | FFA.3S.137.LCN | FFA.4S.130.LC |
| C | 32 | | 3.2 | – | 3.0 | 2.5 | FLA.3S.732.CN ⁴⁾ | – | FFA.3S.130.LC |
| C | 42 | | 4.2 | – | 4.0 | 3.1 | FLA.3S.742.CN ⁴⁾ | – | FFA.3S.130.LC |
| C | 52 | | 5.2 | – | 5.0 | 4.1 | FLA.3S.752.CN ⁴⁾ | – | FFA.3S.130.LC |
| C | 62 | | 6.2 | – | 6.0 | 5.1 | FLA.3S.762.CN ⁴⁾ | – | FFA.3S.130.LC |
| C | 72 | | 7.2 | – | 7.0 | 6.1 | FLA.3S.772.CN ⁴⁾ | – | FFA.3S.130.LC |
| C | 82 | | 8.2 | – | 8.0 | 7.1 | FLA.3S.782.CN ⁴⁾ | – | FFA.3S.130.LC |
| C | 92 | | 9.2 | 8.7 | 9.0 | 8.1 | FLA.3S.792.CN ⁴⁾ | – | FFA.3S.130.LC |
| C | 97 | | 9.7 | 8.7 | 9.5 | 9.1 | FLA.3S.797.CN ⁴⁾ | – | FFA.3S.130.LC |
| C | 10 | | 10.7 | 8.7 | 10.5 | 9.8 | FLA.3S.710.CN ⁴⁾ | – | FFA.3S.130.LC |
| C | 11 | | 10.7 | 9.0 | 10.5 | 10.1 | FLA.3S.711.CN ⁴⁾ | – | FFA.3S.130.LC |
| L | 42 | | 4.2 | – | 4.0 | 3.1 | FFA.3S.742.LN | – | FFA.3S.130.LC |
| L | 52 | | 5.2 | – | 5.0 | 4.1 | FFA.3S.752.LN | – | FFA.3S.130.LC |
| L | 62 | | 6.2 | – | 6.0 | 5.1 | FFA.3S.762.LN | – | FFA.3S.130.LC |
| L | 72 | | 7.2 | – | 7.0 | 6.1 | FFA.3S.772.LN | – | FFA.3S.130.LC |
| L | 82 | | 8.2 | – | 8.0 | 7.1 | FFA.3S.782.LN | – | FFA.3S.130.LC |
| L | 92 | | 9.2 | – | 9.0 | 8.1 | FFA.3S.792.LN | – | FFA.3S.130.LC |
| L | 97 | 9.7 | – | 9.5 | 9.1 | FFA.3S.797.LN | – | FFA.3S.130.LC | |
| L | 10 | 10.2 | – | 10.0 | 9.6 | FFA.3S.710.LN | – | FFA.3S.130.LC | |
| L | 11 | 10.7 | – | 10.5 | 10.1 | FFA.3S.711.LN | – | FFA.3S.130.LC | |

Note:

- ¹⁾ for ordering collets separately.
 - ³⁾ for ordering a K type collet separately, the oversize collet and the corresponding collet nut should also be ordered.
 - ⁴⁾ these collets should be used with FLA, FFP and PCP models.
 - ⁵⁾ for models with bend relief, the FFM.●●.130.LC collet nut should be ordered (see page 76).
- All dimensions are in millimetres.

SPANNZANGEN COLLETS

SERIE S SERIES S



C, K and L type collets

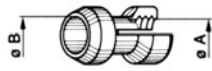

C or K type collet



L type collet

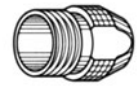
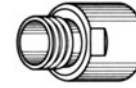

| Reference | | Serie | ø Collet (mm) | | ø Cable (mm) | | Part number of the collet ¹⁾ | Part number of the oversize collet and of the split centre-pieces ³⁾ | Part number of the collet nut ^{3) 5)} |
|-----------|----|-------|---------------|------|--------------|---------------|---|---|--|
| Type | ø | | ø A | ø B | max. | min. | | | |
| C | 52 | 4S | 5.2 | - | 5.0 | 4.1 | FFA.4S.752.CN | - | FFA.4S.130.LC |
| C | 62 | | 6.2 | - | 6.0 | 5.1 | FFA.4S.762.CN | - | FFA.4S.130.LC |
| C | 72 | | 7.2 | - | 7.0 | 6.1 | FFA.4S.772.CN | - | FFA.4S.130.LC |
| C | 82 | | 8.2 | - | 8.0 | 7.1 | FFA.4S.782.CN | - | FFA.4S.130.LC |
| C | 92 | | 9.2 | - | 9.0 | 8.1 | FFA.4S.792.CN | - | FFA.4S.130.LC |
| C | 10 | | 10.2 | - | 10.0 | 9.1 | FFA.4S.710.CN | - | FFA.4S.130.LC |
| C | 11 | | 11.2 | - | 11.0 | 10.1 | FFA.4S.711.CN | - | FFA.4S.130.LC |
| C | 12 | | 12.2 | - | 12.0 | 11.1 | FFA.4S.712.CN | - | FFA.4S.130.LC |
| C | 13 | | 13.2 | 12.2 | 13.0 | 12.6 | FFA.4S.713.CN | - | FFA.4S.130.LC |
| K | 14 | | 14.2 | - | 14.0 | 13.1 | FFA.5S.714.CN | FFA.4S.137.LCN | FFA.5S.130.LC |
| K | 15 | | 15.2 | - | 15.0 | 14.1 | FFA.5S.715.CN | FFA.4S.137.LCN | FFA.5S.130.LC |
| K | 16 | | 16.2 | - | 16.0 | 15.1 | FFA.5S.716.CN | FFA.4S.137.LCN | FFA.5S.130.LC |
| K | 17 | | 17.2 | - | 17.0 | 16.1 | FFA.5S.717.CN | FFA.4S.137.LCN | FFA.5S.130.LC |
| K | 18 | | 18.2 | - | 18.0 | 17.1 | FFA.5S.718.CN | FFA.4S.137.LCN | FFA.5S.130.LC |
| K | 19 | | 19.2 | - | 19.0 | 18.1 | FFA.5S.719.CN | FFA.4S.137.LCN | FFA.5S.130.LC |
| K | 20 | | 20.2 | 19.7 | 20.0 | 19.1 | FFA.5S.720.CN | FFA.4S.137.LCN | FFA.5S.130.LC |
| K | 21 | | 21.2 | 19.7 | 21.0 | 20.1 | FFA.5S.721.CN | FFA.4S.137.LCN | FFA.5S.130.LC |
| K | 22 | | 22.2 | 19.7 | 22.0 | 21.1 | FFA.5S.722.CN | FFA.4S.137.LCN | FFA.5S.130.LC |
| C | 52 | | 5.2 | - | 5.0 | 4.1 | FLA.4S.752.CN ⁴⁾ | - | FFA.4S.130.LC |
| C | 62 | | 6.2 | - | 6.0 | 5.1 | FLA.4S.762.CN ⁴⁾ | - | FFA.4S.130.LC |
| C | 72 | | 7.2 | - | 7.0 | 6.1 | FLA.4S.772.CN ⁴⁾ | - | FFA.4S.130.LC |
| C | 82 | | 8.2 | - | 8.0 | 7.1 | FLA.4S.782.CN ⁴⁾ | - | FFA.4S.130.LC |
| C | 92 | | 9.2 | - | 9.0 | 8.1 | FLA.4S.792.CN ⁴⁾ | - | FFA.4S.130.LC |
| C | 10 | | 10.2 | - | 10.0 | 9.1 | FLA.4S.710.CN ⁴⁾ | - | FFA.4S.130.LC |
| C | 11 | | 11.2 | - | 11.0 | 10.1 | FLA.4S.711.CN ⁴⁾ | - | FFA.4S.130.LC |
| C | 12 | | 12.2 | - | 12.0 | 11.1 | FLA.4S.712.CN ⁴⁾ | - | FFA.4S.130.LC |
| C | 13 | | 13.2 | 12.2 | 13.0 | 12.6 | FLA.4S.713.CN ⁴⁾ | - | FFA.4S.130.LC |
| L | 52 | | 5.2 | - | 5.0 | 4.1 | FFA.4S.752.LN | - | FFA.4S.130.LC |
| L | 62 | | 6.2 | - | 6.0 | 5.1 | FFA.4S.762.LN | - | FFA.4S.130.LC |
| L | 72 | | 7.2 | - | 7.0 | 6.1 | FFA.4S.772.LN | - | FFA.4S.130.LC |
| L | 82 | | 8.2 | - | 8.0 | 7.1 | FFA.4S.782.LN | - | FFA.4S.130.LC |
| L | 92 | | 9.2 | - | 9.0 | 8.1 | FFA.4S.792.LN | - | FFA.4S.130.LC |
| L | 10 | 10.2 | - | 10.0 | 9.1 | FFA.4S.710.LN | - | FFA.4S.130.LC | |
| L | 11 | 11.2 | - | 11.0 | 10.1 | FFA.4S.711.LN | - | FFA.4S.130.LC | |
| L | 12 | 12.2 | - | 12.0 | 11.1 | FFA.4S.712.LN | - | FFA.4S.130.LC | |
| L | 13 | 13.2 | - | 13.0 | 12.6 | FFA.4S.713.LN | - | FFA.4S.130.LC | |

Note:
¹⁾ for ordering collets separately.

³⁾ for ordering a K type collet separately, the oversize collet and the corresponding collet nut should also be ordered.

⁴⁾ these collets should be used with FLA, FFP and PCP models.

⁵⁾ for models with bend relief, the FFM.●●.130.LC collet nut should be ordered (see page 76).

All dimensions are in millimetres. These notes also apply to the following page.



Part number example see page 3



SPANNZANGEN | COLLETS
SERIE S | SERIES S

C and K type collets

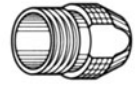
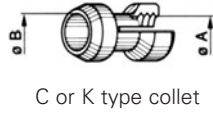

| Reference | | Serie | ø Collet (mm) | | ø Cable (mm) | | Part number of the collet ¹⁾ | Part number of the oversize collet and of the split centre-pieces ³⁾ | Part number of the collet nut ³⁾ |
|-----------|----|-------|---------------|------|--------------|-----------------------------|---|---|---|
| Type | ø | | ø A | ø B | max. | min. | | | |
| C | 72 | 5S | 7.2 | - | 7.0 | 6.1 | FFA.5S.772.CN | - | FFA.5S.130.LC |
| C | 82 | | 8.2 | - | 8.0 | 7.1 | FFA.5S.782.CN | - | FFA.5S.130.LC |
| C | 92 | | 9.2 | - | 9.0 | 8.1 | FFA.5S.792.CN | - | FFA.5S.130.LC |
| C | 10 | | 10.2 | - | 10.0 | 9.1 | FFA.5S.710.CN | - | FFA.5S.130.LC |
| C | 11 | | 11.2 | - | 11.0 | 10.1 | FFA.5S.711.CN | - | FFA.5S.130.LC |
| C | 12 | | 12.2 | - | 12.0 | 11.1 | FFA.5S.712.CN | - | FFA.5S.130.LC |
| C | 13 | | 13.2 | - | 13.0 | 12.1 | FFA.5S.713.CN | - | FFA.5S.130.LC |
| C | 14 | | 14.2 | - | 14.0 | 13.1 | FFA.5S.714.CN | - | FFA.5S.130.LC |
| C | 15 | | 15.2 | - | 15.0 | 14.1 | FFA.5S.715.CN | - | FFA.5S.130.LC |
| C | 16 | | 16.2 | - | 16.0 | 15.1 | FFA.5S.716.CN | - | FFA.5S.130.LC |
| C | 17 | | 17.2 | - | 17.0 | 16.1 | FFA.5S.717.CN | - | FFA.5S.130.LC |
| C | 18 | | 18.2 | - | 18.0 | 17.1 | FFA.5S.718.CN | - | FFA.5S.130.LC |
| C | 19 | | 19.2 | - | 19.0 | 18.1 | FFA.5S.719.CN | - | FFA.5S.130.LC |
| C | 20 | | 20.2 | 19.7 | 20.0 | 19.1 | FFA.5S.720.CN | - | FFA.5S.130.LC |
| C | 21 | | 21.2 | 19.7 | 21.0 | 20.1 | FFA.5S.721.CN | - | FFA.5S.130.LC |
| C | 22 | | 22.2 | 19.7 | 22.0 | 21.1 | FFA.5S.722.CN | - | FFA.5S.130.LC |
| K | 23 | | 23.2 | - | 23.0 | 22.1 | FFA.6S.723.CN | FFA.5S.137.LCN | FFA.6S.130.LC |
| K | 24 | | 24.2 | - | 24.0 | 23.1 | FFA.6S.724.CN | FFA.5S.137.LCN | FFA.6S.130.LC |
| K | 25 | | 25.2 | - | 25.0 | 24.1 | FFA.6S.725.CN | FFA.5S.137.LCN | FFA.6S.130.LC |
| K | 26 | | 26.2 | - | 26.0 | 25.1 | FFA.6S.726.CN | FFA.5S.137.LCN | FFA.6S.130.LC |
| K | 27 | | 27.2 | - | 27.0 | 26.1 | FFA.6S.727.CN | FFA.5S.137.LCN | FFA.6S.130.LC |
| K | 28 | | 28.2 | 27.2 | 28.0 | 27.1 | FFA.6S.728.CN | FFA.5S.137.LCN | FFA.6S.130.LC |
| K | 29 | 29.2 | 27.2 | 29.0 | 28.1 | FFA.6S.729.CN | FFA.5S.137.LCN | FFA.6S.130.LC | |
| K | 30 | 30.2 | 27.2 | 30.0 | 29.1 | FFA.6S.730.CN | FFA.5S.137.LCN | FFA.6S.130.LC | |
| C | 72 | 7.2 | - | 7.0 | 6.1 | FLA.5S.772.CN ²⁾ | - | FFA.5S.130.LC | |
| C | 82 | 8.2 | - | 8.0 | 7.1 | FLA.5S.782.CN ²⁾ | - | FFA.5S.130.LC | |
| C | 92 | 9.2 | - | 9.0 | 8.1 | FLA.5S.792.CN ²⁾ | - | FFA.5S.130.LC | |
| C | 10 | 10.2 | - | 10.0 | 9.1 | FLA.5S.710.CN ²⁾ | - | FFA.5S.130.LC | |
| C | 11 | 11.2 | - | 11.0 | 10.1 | FLA.5S.711.CN ²⁾ | - | FFA.5S.130.LC | |
| C | 12 | 12.2 | - | 12.0 | 11.1 | FLA.5S.712.CN ²⁾ | - | FFA.5S.130.LC | |
| C | 13 | 13.2 | - | 13.0 | 12.1 | FLA.5S.713.CN ²⁾ | - | FFA.5S.130.LC | |
| C | 14 | 14.2 | - | 14.0 | 13.1 | FLA.5S.714.CN ²⁾ | - | FFA.5S.130.LC | |
| C | 15 | 15.2 | - | 15.0 | 14.1 | FLA.5S.715.CN ²⁾ | - | FFA.5S.130.LC | |
| C | 16 | 16.2 | - | 16.0 | 15.1 | FLA.5S.716.CN ²⁾ | - | FFA.5S.130.LC | |
| C | 17 | 17.2 | - | 17.0 | 16.1 | FLA.5S.717.CN ²⁾ | - | FFA.5S.130.LC | |
| C | 18 | 18.2 | - | 18.0 | 17.1 | FLA.5S.718.CN ²⁾ | - | FFA.5S.130.LC | |
| C | 19 | 19.2 | - | 19.0 | 18.1 | FLA.5S.719.CN ²⁾ | - | FFA.5S.130.LC | |
| C | 20 | 20.2 | 19.7 | 20.0 | 19.1 | FLA.5S.720.CN ²⁾ | - | FFA.5S.130.LC | |
| C | 21 | 21.2 | 19.7 | 21.0 | 20.1 | FLA.5S.721.CN ²⁾ | - | FFA.5S.130.LC | |
| C | 22 | 22.2 | 19.7 | 22.0 | 21.1 | FLA.5S.722.CN ²⁾ | - | FFA.5S.130.LC | |

Continuation on page 76

SPANNZANGEN COLLETS

SERIE S SERIES S



L type collet



L type collet

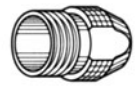

| Reference | | Serie | ø Collet (mm) | | ø Cable (mm) | | Part number of the collet ¹⁾ | Part number of the oversize collet and of the split centre-pieces ³⁾ | Part number of the collet nut ³⁾ |
|-----------|----|-------|---------------|-----|--------------|------|---|---|---|
| Type | ø | | ø A | ø B | max. | min. | | | |
| L | 92 | 5S | 9.2 | – | 9.0 | 8.1 | FFA.5S.792.LN | – | FFA.5S.130.LC |
| L | 10 | | 10.2 | – | 10.0 | 9.1 | FFA.5S.710.LN | – | FFA.5S.130.LC |
| L | 11 | | 11.2 | – | 11.0 | 10.1 | FFA.5S.711.LN | – | FFA.5S.130.LC |
| L | 12 | | 12.2 | – | 12.0 | 11.1 | FFA.5S.712.LN | – | FFA.5S.130.LC |
| L | 13 | | 13.2 | – | 13.0 | 12.1 | FFA.5S.713.LN | – | FFA.5S.130.LC |
| L | 14 | | 14.2 | – | 14.0 | 13.1 | FFA.5S.714.LN | – | FFA.5S.130.LC |
| L | 15 | | 15.2 | – | 15.0 | 14.1 | FFA.5S.715.LN | – | FFA.5S.130.LC |
| L | 16 | | 16.2 | – | 16.0 | 15.1 | FFA.5S.716.LN | – | FFA.5S.130.LC |
| L | 17 | | 17.2 | – | 17.0 | 16.1 | FFA.5S.717.LN | – | FFA.5S.130.LC |
| L | 18 | | 18.2 | – | 18.0 | 17.1 | FFA.5S.718.LN | – | FFA.5S.130.LC |
| L | 19 | | 19.2 | – | 19.0 | 18.1 | FFA.5S.719.LN | – | FFA.5S.130.LC |
| L | 20 | | 20.2 | – | 20.0 | 19.1 | FFA.5S.720.LN | – | FFA.5S.130.LC |
| L | 21 | | 21.2 | – | 21.0 | 20.1 | FFA.5S.721.LN | – | FFA.5S.130.LC |

Bend relief nut and bend relief

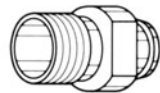

| Reference | | Serie | Part number of the collet nut | Bend relief to be used ¹⁾ |
|-----------|----------|-------|-------------------------------|--------------------------------------|
| Type | ø | | | |
| C | 27 to 42 | 0S | FFM.0S.130.LC | GMA.0B.0••.D• |
| K | 47 to 62 | | FFM.1S.130.LC | GMA.1B.0••.D• |
| L | 27 to 42 | | FFM.0S.130.LC | GMA.0B.0••.D• |
| C | 27 to 62 | 1S | FFM.1S.130.LC | GMA.1B.0••.D• |
| K | 72 to 82 | | FFM.2S.130.LC | GMA.2B.0••.D• |
| L | 27 to 62 | | FFM.1S.130.LC | GMA.1B.0••.D• |
| C | 42 to 82 | 2S | FFM.2S.130.LC | GMA.2B.0••.D• |
| K | 92 to 10 | | FFM.3S.130.LC | GMA.3B.0••.D• |
| L | 42 to 82 | | FFM.2S.130.LC | GMA.2B.0••.D• |
| C | 52 to 10 | 3S | FFM.3S.130.LC | GMA.3B.0••.D• |
| K | 12 to 13 | | FFM.4S.130.LC | GMA.4B.0••.D• |
| L | 52 to 10 | | FFM.3S.130.LC | GMA.3B.0••.D• |
| C | 82 to 13 | 4S | FFM.4S.130.LC | GMA.4B.0••.D• |
| L | 82 to 13 | | FFM.4S.130.LC | GMA.4B.0••.D• |

Note:
¹⁾ the bend relief is to be ordered separately (see page 80).



Part number example see page 3



SPANNZANGEN | COLLETS
SERIE E | SERIES E

C and K type collets



| Reference | | Serie | ø Collet (mm) | | ø Cable (mm) | | Part number of the collet system ¹⁾ | Part number of the oversize collet and of the split centre-pieces ²⁾ | Part number of the collet nut ²⁾ | |
|-----------|----|-------|---------------|------|--------------|------|--|---|---|---------------|
| Type | ø | | ø A | ø B | max. | min. | | | | |
| C | 10 | 0E | 1.6 | – | 1.2 | 1.0 | FFA.0E.710.CNS | – | FFA.00.130.LC | |
| C | 15 | | 1.6 | – | 1.5 | 1.3 | FFA.0E.715.CNS | – | FFA.00.130.LC | |
| C | 20 | | 2.1 | – | 2.0 | 1.6 | FFA.0E.720.CNS | – | FFA.00.130.LC | |
| C | 25 | | 3.1 | – | 2.5 | 2.1 | FFA.0E.725.CNS | – | FFA.00.130.LC | |
| C | 30 | | 3.1 | – | 3.0 | 2.6 | FFA.0E.730.CNS | – | FFA.00.130.LC | |
| C | 35 | | 4.2 | 4.2 | 3.5 | 3.1 | FFA.0E.735.CNS | – | FFA.00.130.LC | |
| C | 40 | | 4.2 | 4.2 | 4.0 | 3.6 | FFA.0E.740.CNS | – | FFA.00.130.LC | |
| C | 45 | | 5.2 | 5.2 | 4.5 | 4.1 | FFA.0E.745.CNS | – | FFA.00.130.LC | |
| C | 50 | | 5.2 | 5.2 | 5.0 | 4.6 | FFA.0E.750.CNS | – | FFA.00.130.LC | |
| C | 15 | 1E | 1.6 | – | 1.5 | 1.3 | FFA.1E.715.CNS | – | FFA.1E.130.LC | |
| C | 20 | | 2.2 | – | 2.0 | 1.6 | FFA.1E.720.CNS | – | FFA.1E.130.LC | |
| C | 25 | | 3.2 | – | 2.5 | 2.1 | FFA.1E.725.CNS | – | FFA.1E.130.LC | |
| C | 30 | | 3.2 | – | 3.0 | 2.6 | FFA.1E.730.CNS | – | FFA.1E.130.LC | |
| C | 35 | | 4.2 | – | 3.5 | 3.1 | FFA.1E.735.CNS | – | FFA.1E.130.LC | |
| C | 40 | | 4.2 | – | 4.0 | 3.6 | FFA.1E.740.CNS | – | FFA.1E.130.LC | |
| C | 45 | | 5.2 | – | 4.5 | 4.1 | FFA.1E.745.CNS | – | FFA.1E.130.LC | |
| C | 50 | | 5.2 | – | 5.0 | 4.6 | FFA.1E.750.CNS | – | FFA.1E.130.LC | |
| C | 55 | | 6.2 | 6.2 | 5.5 | 5.1 | FFA.1E.755.CNS | – | FFA.1E.130.LC | |
| C | 60 | | 6.2 | 6.2 | 6.0 | 5.6 | FFA.1E.760.CNS | – | FFA.1E.130.LC | |
| C | 65 | | 7.2 | 6.7 | 6.5 | 6.1 | FFA.1E.765.CNS | – | FFA.1E.130.LC | |
| K | 70 | | 7.2 | – | 7.0 | 6.6 | FFA.2E.770.CNS | FFA.1E.137.LCN | FFA.2E.130.LC | |
| K | 75 | | 8.2 | 8.2 | 7.5 | 7.1 | FFA.2E.775.CNS | FFA.1E.137.LCN | FFA.2E.130.LC | |
| K | 80 | | 8.2 | 8.2 | 8.0 | 7.6 | FFA.2E.780.CNS | FFA.1E.137.LCN | FFA.2E.130.LC | |
| K | 85 | | 9.2 | 8.6 | 8.5 | 8.1 | FFA.2E.785.CNS | FFA.1E.137.LCN | FFA.2E.130.LC | |
| C | 15 | | 2E | 2.2 | – | 1.5 | 1.3 | FFA.2E.715.CNS | – | FFA.2E.130.LC |
| C | 20 | | | 2.2 | – | 2.0 | 1.6 | FFA.2E.720.CNS | – | FFA.2E.130.LC |
| C | 25 | 3.2 | | – | 2.5 | 2.1 | FFA.2E.725.CNS | – | FFA.2E.130.LC | |
| C | 30 | 3.2 | | – | 3.0 | 2.6 | FFA.2E.730.CNS | – | FFA.2E.130.LC | |
| C | 35 | 4.2 | | – | 3.5 | 3.1 | FFA.2E.735.CNS | – | FFA.2E.130.LC | |
| C | 40 | 4.2 | | – | 4.0 | 3.6 | FFA.2E.740.CNS | – | FFA.2E.130.LC | |
| C | 45 | 5.2 | | – | 4.5 | 4.1 | FFA.2E.745.CNS | – | FFA.2E.130.LC | |
| C | 50 | 5.2 | | – | 5.0 | 4.6 | FFA.2E.750.CNS | – | FFA.2E.130.LC | |
| C | 55 | 6.2 | | – | 5.5 | 5.1 | FFA.2E.755.CNS | – | FFA.2E.130.LC | |
| C | 60 | 6.2 | | – | 6.0 | 5.6 | FFA.2E.760.CNS | – | FFA.2E.130.LC | |
| C | 65 | 7.2 | | – | 6.5 | 6.1 | FFA.2E.765.CNS | – | FFA.2E.130.LC | |
| C | 70 | 7.2 | | – | 7.0 | 6.6 | FFA.2E.770.CNS | – | FFA.2E.130.LC | |
| C | 75 | 8.2 | | 8.2 | 7.5 | 7.1 | FFA.2E.775.CNS | – | FFA.2E.130.LC | |
| C | 80 | 8.2 | | 8.2 | 8.0 | 7.6 | FFA.2E.780.CNS | – | FFA.2E.130.LC | |
| C | 85 | 9.2 | | 8.6 | 8.5 | 8.1 | FFA.2E.785.CNS | – | FFA.2E.130.LC | |
| K | 90 | 9.2 | | – | 9.0 | 8.6 | FFA.3E.790.CNS | FFA.2E.137.LCN | FFA.3E.130.LC | |
| K | 95 | 10.2 | | 10.2 | 9.5 | 9.1 | FFA.3E.795.CNS | FFA.2E.137.LCN | FFA.3E.130.LC | |
| K | 10 | 10.2 | | 10.2 | 10.0 | 9.6 | FFA.3E.710.CNS | FFA.2E.137.LCN | FFA.3E.130.LC | |
| K | 11 | 11.2 | | 10.6 | 11.0 | 10.1 | FFA.3E.711.CNS | FFA.2E.137.LCN | FFA.3E.130.LC | |

Note:

¹⁾ for ordering the collet system separately.

²⁾ for ordering a K type collet separately, the oversize collet and the corresponding collet nut should also be ordered (see page 79).

All dimensions are in millimetres.

SPANNZANGEN COLLETS

SERIE E SERIES E



C and K type collets



| Reference | | Serie | ø Collet (mm) | | ø Cable (mm) | | Part number of the collet system ¹⁾ | Part number of the oversize collet and of the split centre-pieces ²⁾ | Part number of the collet nut ²⁾ |
|-----------|----|-------|---------------|------|--------------|----------------|--|---|---|
| Type | ø | | ø A | ø B | max. | min. | | | |
| C | 30 | 3E | 3.2 | - | 3.0 | 2.6 | FFA.3E.730.CNS | - | FFA.3E.130.LC |
| C | 35 | | 4.2 | - | 3.5 | 3.1 | FFA.3E.735.CNS | - | FFA.3E.130.LC |
| C | 40 | | 4.2 | - | 4.0 | 3.6 | FFA.3E.740.CNS | - | FFA.3E.130.LC |
| C | 45 | | 5.2 | - | 4.5 | 4.1 | FFA.3E.745.CNS | - | FFA.3E.130.LC |
| C | 50 | | 5.2 | - | 5.0 | 4.6 | FFA.3E.750.CNS | - | FFA.3E.130.LC |
| C | 55 | | 6.2 | - | 5.5 | 5.1 | FFA.3E.755.CNS | - | FFA.3E.130.LC |
| C | 60 | | 6.2 | - | 6.0 | 5.6 | FFA.3E.760.CNS | - | FFA.3E.130.LC |
| C | 65 | | 7.2 | - | 6.5 | 6.1 | FFA.3E.765.CNS | - | FFA.3E.130.LC |
| C | 70 | | 7.2 | - | 7.0 | 6.6 | FFA.3E.770.CNS | - | FFA.3E.130.LC |
| C | 75 | | 8.2 | - | 7.5 | 7.1 | FFA.3E.775.CNS | - | FFA.3E.130.LC |
| C | 80 | | 8.2 | - | 8.0 | 7.6 | FFA.3E.780.CNS | - | FFA.3E.130.LC |
| C | 85 | | 9.2 | - | 8.5 | 8.1 | FFA.3E.785.CNS | - | FFA.3E.130.LC |
| C | 90 | | 9.2 | - | 9.0 | 8.6 | FFA.3E.790.CNS | - | FFA.3E.130.LC |
| C | 95 | | 10.2 | 10.2 | 9.5 | 9.1 | FFA.3E.795.CNS | - | FFA.3E.130.LC |
| C | 10 | | 10.2 | 10.2 | 10.0 | 9.6 | FFA.3E.710.CNS | - | FFA.3E.130.LC |
| C | 11 | | 11.2 | 11.2 | 11.0 | 10.1 | FFA.3E.711.CNS | - | FFA.3E.130.LC |
| K | 11 | | 12.3 | - | 12.0 | 10.6 | FFA.4E.711.CNS | FFA.3E.137.LCN | FFA.4E.130.LC |
| K | 12 | 13.8 | 13.8 | 12.8 | 12.1 | FFA.4E.712.CNS | FFA.3E.137.LCN | FFA.4E.130.LC | |
| K | 13 | 13.8 | 13.8 | 13.5 | 12.9 | FFA.4E.713.CNS | FFA.3E.137.LCN | FFA.4E.130.LC | |
| K | 14 | 15.3 | 15.3 | 14.0 | 13.6 | FFA.4E.714.CNS | FFA.3E.137.LCN | FFA.4E.130.LC | |
| K | 15 | 15.3 | 15.3 | 15.0 | 14.1 | FFA.4E.715.CNS | FFA.3E.137.LCN | FFA.4E.130.LC | |
| C | 50 | 4E | 6.3 | - | 5.0 | 4.6 | FFA.4E.750.CNS | - | FFA.4E.130.LC |
| C | 55 | | 6.3 | - | 5.5 | 5.1 | FFA.4E.755.CNS | - | FFA.4E.130.LC |
| C | 60 | | 6.3 | - | 6.0 | 5.6 | FFA.4E.760.CNS | - | FFA.4E.130.LC |
| C | 65 | | 7.3 | - | 6.5 | 6.1 | FFA.4E.765.CNS | - | FFA.4E.130.LC |
| C | 70 | | 7.3 | - | 7.0 | 6.6 | FFA.4E.770.CNS | - | FFA.4E.130.LC |
| C | 75 | | 8.3 | - | 7.5 | 7.1 | FFA.4E.775.CNS | - | FFA.4E.130.LC |
| C | 80 | | 8.3 | - | 8.0 | 7.6 | FFA.4E.780.CNS | - | FFA.4E.130.LC |
| C | 85 | | 9.3 | - | 8.5 | 8.1 | FFA.4E.785.CNS | - | FFA.4E.130.LC |
| C | 90 | | 9.3 | - | 9.0 | 8.6 | FFA.4E.790.CNS | - | FFA.4E.130.LC |
| C | 95 | | 10.8 | - | 9.5 | 9.1 | FFA.4E.795.CNS | - | FFA.4E.130.LC |
| C | 10 | | 10.8 | - | 10.5 | 9.6 | FFA.4E.710.CNS | - | FFA.4E.130.LC |
| C | 11 | | 12.3 | - | 12.0 | 10.6 | FFA.4E.711.CNS | - | FFA.4E.130.LC |
| C | 12 | | 13.8 | 13.8 | 12.8 | 12.1 | FFA.4E.712.CNS | - | FFA.4E.130.LC |
| C | 13 | | 13.8 | 13.8 | 13.5 | 12.9 | FFA.4E.713.CNS | - | FFA.4E.130.LC |
| C | 14 | | 15.3 | 15.3 | 14.0 | 13.6 | FFA.4E.714.CNS | - | FFA.4E.130.LC |
| C | 15 | | 15.3 | 15.3 | 15.0 | 14.1 | FFA.4E.715.CNS | - | FFA.4E.130.LC |
| K | 16 | | 17.8 | - | 16.5 | 15.6 | FFA.4K.716.CNS | FFA.4E.137.LCN ³⁾ | FFA.4K.136.LC |
| K | 17 | | 17.8 | - | 17.5 | 16.6 | FFA.4K.717.CNS | FFA.4E.137.LCN | FFA.4K.136.LC |
| K | 18 | | 19.8 | - | 18.5 | 17.6 | FFA.4K.718.CNS | FFA.4E.137.LCN | FFA.4K.136.LC |
| K | 19 | | 19.8 | - | 19.5 | 18.6 | FFA.4K.719.CNS | FFA.4E.137.LCN | FFA.4K.136.LC |
| K | 20 | | 21.8 | - | 20.5 | 19.6 | FFA.4K.720.CNS | FFA.4E.137.LCN | FFA.4K.136.LC |
| K | 21 | | 21.8 | - | 21.5 | 20.6 | FFA.4K.721.CNS | FFA.4E.137.LCN | FFA.4K.136.LC |
| K | 22 | | 23.8 | 23.8 | 22.5 | 21.6 | FFA.4K.722.CNS | FFA.4E.137.LCN | FFA.4K.136.LC |
| K | 23 | 23.8 | 23.8 | 23.5 | 22.6 | FFA.4K.723.CNS | FFA.4E.137.LCN | FFA.4K.136.LC | |

Note: ¹⁾ for ordering the collet system separately.

²⁾ for ordering a K type collet separately, the oversize collet and the corresponding collet nut should also be ordered (see page 79).

³⁾ in 4E series, the centre-piece is made of one piece. All dimensions are in millimetres.



Part number example see page 3



SPANNZANGEN | COLLETS
SERIE E | SERIES E

C type collets



| Reference | | Serie | ø Collet (mm) | | ø Cable (mm) | | Part number of the collet system ¹⁾ | Part number of the collet nut |
|-----------|----|-------|---------------|------|--------------|------|--|-------------------------------|
| Type | ø | | ø A | ø B | max. | min. | | |
| C | 10 | 5E | 11.8 | – | 10.5 | 9.6 | FFA.5K.710.CNS | FFA.5K.130.LC |
| C | 11 | | 11.8 | – | 11.5 | 10.6 | FFA.5K.711.CNS | FFA.5K.130.LC |
| C | 12 | | 13.8 | – | 12.5 | 11.6 | FFA.5K.712.CNS | FFA.5K.130.LC |
| C | 13 | | 13.8 | – | 13.5 | 12.6 | FFA.5K.713.CNS | FFA.5K.130.LC |
| C | 14 | | 15.8 | – | 14.5 | 13.6 | FFA.5K.714.CNS | FFA.5K.130.LC |
| C | 15 | | 15.8 | – | 15.5 | 14.6 | FFA.5K.715.CNS | FFA.5K.130.LC |
| C | 16 | | 17.8 | – | 16.5 | 15.6 | FFA.5K.716.CNS | FFA.5K.130.LC |
| C | 17 | | 17.8 | – | 17.5 | 16.6 | FFA.5K.717.CNS | FFA.5K.130.LC |
| C | 18 | | 19.8 | – | 18.5 | 17.6 | FFA.5K.718.CNS | FFA.5K.130.LC |
| C | 19 | | 19.8 | – | 19.5 | 18.6 | FFA.5K.719.CNS | FFA.5K.130.LC |
| C | 20 | | 21.8 | – | 20.5 | 19.6 | FFA.5K.720.CNS | FFA.5K.130.LC |
| C | 21 | | 21.8 | – | 21.5 | 20.6 | FFA.5K.721.CNS | FFA.5K.130.LC |
| C | 22 | | 23.8 | 23.8 | 22.5 | 21.6 | FFA.5K.722.CNS | FFA.5K.130.LC |
| C | 23 | | 23.8 | 23.8 | 23.5 | 22.6 | FFA.5K.723.CNS | FFA.5K.130.LC |

Note:

¹⁾ for ordering the collet system separately.

Bend relief nut and bend relief



| Reference | | Serie | Part number of the collet nut | Bend relief to be used ¹⁾ |
|-----------|----------|-------|-------------------------------|--------------------------------------|
| Type | ø | | | |
| C | 10 to 50 | 0E | FFM.0E.130.LC | GMA.0B.***.. |
| C | 15 to 65 | 1E | FFM.1E.130.LC | GMA.1B.***.. |
| K | 70 to 85 | | FFM.2E.130.LC | GMA.2B.***.. |
| C | 15 to 85 | 2E | FFM.2E.130.LC | GMA.2B.***.. |
| K | 90 to 11 | | FFM.3E.130.LC | GMA.3B.***.. |
| C | 30 to 10 | 3E | FFM.3E.130.LC | GMA.3B.***.. |
| K | 11 to 15 | | FFM.4E.130.LC | GMA.4B.***.. |
| C | 50 to 15 | 4E | FFM.4E.130.LC | GMA.4B.***.. |

Note:

¹⁾ the bend relief is to be ordered separately (see page 80).
All dimensions are in millimetres.



KATALOGÜBERSICHT CATALOG SUMMARY

Please request the appropriate catalog from our marketing department, or directly: www.lemo.de

Connectors

- F-Series – Harsh Environment Connectors
- Special cable and fibre optic cable
- Thermo Series – for the highest measure range in temperature
- Multifunctional connector combinations for the CAMAC-technology
- Connectors, Audio-Video
- P-Series (REDEL)
- Unipole & Multipole Connectors

Fibre optic connectors

Monomode and Multimode according to LEMO-Push-Pull-System

Coaxial Connectors

(COELVER)

Bitte fordern Sie Ihren entsprechenden Katalog von unserer Marketing-Abteilung an, oder direkt unter: www.lemo.de

Steckverbindungen

- F-Serie – Für harte Anwendungsgebiete
- Spezialkabel und LWL-Leitungen
- Serie Thermo für höchste Temperatur-Messbereiche
- Vielseitige Steckkombinationen in der CAMAC-Technik
- Connectors, Audio-Video
- P-Series (REDEL)
- Unipole & Multipole Connectors

Glasfaser-Steckverbindungen

Monomode und Multimode nach dem LEMO-Push-Pull-System

Koaxial Steckverbinder

(COELVER)



LEMO HEADQUARTERS

SWITZERLAND

LEMO SA

Chemin des Champs-Courbes 28 - P.O. Box 194 - CH-1024 Ecublens
Tel. (+41 21) 695 16 00 - Fax (+41 21) 695 16 02 - e-mail: info@lemo.com

LEMO SUBSIDIARIES

AUSTRIA

LEMO Elektronik GesmbH

Ameisgasse 49-51 / DG1
1140 Wien
Tel: (+43 1) 914 23 20 0
Fax: (+43 1) 911 70 90
sales@lemo.at

LEMO JAPAN Ltd

2-7-22, Mita,
Minato-ku, Tokyo
108-0073 JAPAN
81-3-5446-5510
81-3-5446-5511

LEMO Trading (Shanghai) Co., Ltd.

5th Floor, Block 6, City of ELITE,
1000 Jinhai Road
Shanghai, China 201206
(86 21) 5899 7721
(86 21) 5899 7727

LEMO Connectors Nederland BV

De Trompet 1060
1967 DA Heemskerk
(31) 251 25 78 20
(31) 251 25 78 21

DENMARK

LEMO Denmark A/S

Gammel Mosevej 46
2820 Gentofte
Tel: (+45) 45 20 44 00
Fax: (+45) 45 20 44 01
info-dk@lemo.com

NORWAY / ICELAND

LEMO Norway A/S

Stanseveien 6B
0975 Oslo
Tel: (+47) 22 91 70 40
Fax: (+47) 22 91 70 41
info-no@lemo.com

FRANCE

LEMO France Sàrl

165, avenue Jean Jaurès
94700 Maisons Alfort
Tel: (+33 1) 45 17 27 90
Fax: (+33 1) 45 17 27 99
info-fr@lemo.com

SPAIN / PORTUGAL

IBERLEMO S.A.

Brasil, 45, 08402 Granollers
Barcelona
Tel: (+34 93) 860 44 20
Fax: (+34 93) 879 10 77
info-es@lemo.com

GERMANY

LEMO Elektronik GmbH

Hanns-Schwindt-Str. 6
81829 München
Tel: (+49 89) 42 77 03
Fax: (+49 89) 420 21 92
info@lemo.de

SWEDEN / FINLAND

LEMO Nordic AB

Mariehällsvägen 39A
168 65 Bromma
Tel: (+46 8) 635 60 60
Fax: (+46 8) 635 60 61
info-se@lemo.com

HONG KONG

LEMO Hong Kong Ltd.

Room 33, 7th Floor
HITEC, 1 Trademart Drive
Kowloon Bay - Hong Kong
Tel: (+852) 21 74 04 68
Fax: (+852) 21 74 04 92
hk.sales@lemo.com

SWITZERLAND

LEMO Verkauf AG

Grundstrasse 22 B
6343 Rotkreuz
Tel: (+41 41) 790 49 40
Fax: (+41 41) 790 49 43
ch.sales@lemo.com

HUNGARY

REDEL Elektronika Kft

Vágóhíd u. 26
1201 Budapest XX.
Tel: (+36 1) 421 47 10
Fax: (+36 1) 421 47 57
info-hu@lemo.com

UNITED KINGDOM

LEMO UK Ltd

Unit 15 & 16
Hazelwood Trading Estate
Worthing
West Sussex, BN14 8NP
Tel: (+44 1903) 23 45 43
Fax: (+44 1903) 20 62 31
lemo-uk@lemo.com

ITALY

LEMO Italia srl

Viale Lunigiana 25
20125 Milano
Tel: (+39 02) 66 71 10 46
Fax: (+39 02) 66 71 10 66
sales.it@lemo.com

USA

LEMO USA Inc

P.O. Box 2408
Rohnert Park
CA 94927-2408
Tel: (+1 707) 578 88 11
(+1 800) 444 53 66
Fax: (+1 707) 578 03 69
info@lemousa.com

LEMO DISTRIBUTORS

AUSTRALIA, BRAZIL, CANADA, CZECH REPUBLIC, GREECE, INDIA, ISRAEL,
MALAYSIA, NEW ZEALAND, PHILIPPINES, POLAND, RUSSIA, SINGAPORE,
SOUTH AFRICA, SOUTH KOREA, TAIWAN, THAILAND, TURKEY, UKRAINE

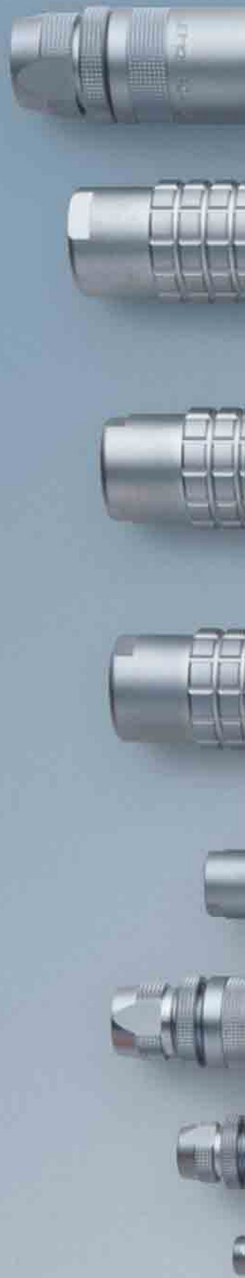

Mouser Electronics

Authorized Distributor

Click to View Pricing, Inventory, Delivery & Lifecycle Information:

LEMO:

[FFA.1S.305.CLAC27](#) [FFA.1S.304.CLAZ](#) [FFA.4S.842.ZLA1](#) [FFA.1E.303.CLAC35](#) [ERA.1S.408.CLL](#)
[FFA.2C.314.CLAC80Z](#) [FFA.1S.305.CLAC66](#) [FFA.0E.250.CTAC30Z](#) [FFA.1S.304.CLAC52Z](#) [FFA.1E.302.CLAC50](#)
[FFA.1S.304.CLAC32](#) [FFA.00.250.NTAC29Z](#) [FFA.4S.313.ZLA](#) [FFA.1S.303.CLAL42](#) [FFA.0S.302.CLAK57](#)
[FFA.0S.303.CLAK52](#) [FFA.0S.304.CLAK52](#) [FFA.2S.310.CLAC52](#) [FFA.2E.702.CJAC70Z](#) [FFA.1S.303.CLAC47](#)
[FFA.00.250.CTAC27](#) [ERA.0S.403.CLL](#) [FFA.0E.730.CNS](#) [EGG.3B.718.CJL](#) [FFA.1E.302.CLAC65Z](#)
[FFA.2S.305.CLAC42](#) [FFA.1S.302.CLAC52](#) [FFA.1S.130.LC](#) [FFA.0S.137.LCN](#) [FFA.0S.302.CLAK68](#) [EGG.1B.731.CJL](#)
[EGG.1B.731.ZJL](#) [EGG.2B.704.CLL](#) [ERA.0S.403.CTL](#) [ERA.1Y.405.CTL](#) [ERA.1Y.410.CLL](#) [ERA.1Y.410.CTA](#)
[ERA.1Y.410.CTL](#) [ERA.1Y.416.CLL](#) [ERA.1Y.416.CLL37](#) [ERA.3E.734.CJL](#) [ERA.3Y.260.CZZ](#) [ERA.3Y.430.CTA](#)
[ERA.3Y.430.CTL](#) [ERA.3Y.430.CTLZ](#) [ERA.3Y.487.HT](#) [ERA.6Y.450.CLL](#) [ERD.3Y.415.CTLM](#) [FFA.00.010.CZZN22](#)
[FFA.00.110.CZZ](#) [FFA.00.110.KZZ](#) [FFA.00.110.NZZ](#) [FFA.00.113.CLAC22](#) [FFA.00.113.CLAC27](#) [FFA.00.113.CLAC29](#)
[FFA.00.113.CLAC31](#) [FFA.00.113.CLAK37Z](#) [FFA.00.113.CTAC22](#) [FFA.00.113.CTAC22Z](#) [FFA.00.113.CTAC27](#)
[FFA.00.113.CTAC27Z](#) [FFA.00.113.CTAC29](#) [FFA.00.113.CTAC29Z](#) [FFA.00.113.CTAC31](#) [FFA.00.113.CTAC31Z](#)
[FFA.00.113.ZLA](#) [FFA.00.113.ZNA](#) [FFA.00.113.ZTA](#) [FFA.00.130.LC](#) [FFA.00.130.LD](#) [FFA.00.130.LN](#) [FFA.00.137.LC](#)
[FFA.00.137.LCN](#) [FFA.00.151.LN](#) [FFA.00.152.LN](#) [FFA.00.250.CLAC22](#) [FFA.00.250.CLAC22Z](#)
[FFA.00.250.CLAC27Z](#) [FFA.00.250.CLAC31](#) [FFA.00.250.CLLC29](#) [FFA.00.250.CTAC22](#) [FFA.00.250.CTAC22Z](#)
[FFA.00.250.CTAC27Z](#) [FFA.00.250.CTAC31](#) [FFA.00.250.CTAC31Z](#) [FFA.00.250.CTAK37](#) [FFA.00.250.CTAK37Z](#)
[FFA.00.250.CTAK42](#) [FFA.00.250.CTAK42Z](#) [FFA.00.250.CTAZ](#) [FFA.00.250.CTAZZ](#) [FFA.00.250.CTLC22](#)
[FFA.00.250.CTLC22Z](#) [FFA.00.250.CTLC27](#) [FFA.00.250.CTLC27Z](#) [FFA.00.250.CTLC29](#) [FFA.00.250.CTLC29Z](#)
[FFA.00.250.DTAC15](#) [FFA.00.250.DTAC22](#) [FFA.00.250.DTAC22Z](#)



Компания «ЭлектроПласт» предлагает заключение долгосрочных отношений при поставках импортных электронных компонентов на взаимовыгодных условиях!

Наши преимущества:

- Оперативные поставки широкого спектра электронных компонентов отечественного и импортного производства напрямую от производителей и с крупнейших мировых складов;
- Поставка более 17-ти миллионов наименований электронных компонентов;
- Поставка сложных, дефицитных, либо снятых с производства позиций;
- Оперативные сроки поставки под заказ (от 5 рабочих дней);
- Экспресс доставка в любую точку России;
- Техническая поддержка проекта, помощь в подборе аналогов, поставка прототипов;
- Система менеджмента качества сертифицирована по Международному стандарту ISO 9001;
- Лицензия ФСБ на осуществление работ с использованием сведений, составляющих государственную тайну;
- Поставка специализированных компонентов (Xilinx, Altera, Analog Devices, Intersil, Interpoint, Microsemi, Aeroflex, Peregrine, Syfer, Eurofarad, Texas Instrument, Miteq, Cobham, E2V, MA-COM, Hittite, Mini-Circuits, General Dynamics и др.);

Помимо этого, одним из направлений компании «ЭлектроПласт» является направление «Источники питания». Мы предлагаем Вам помощь Конструкторского отдела:

- Подбор оптимального решения, техническое обоснование при выборе компонента;
- Подбор аналогов;
- Консультации по применению компонента;
- Поставка образцов и прототипов;
- Техническая поддержка проекта;
- Защита от снятия компонента с производства.



Как с нами связаться

Телефон: 8 (812) 309 58 32 (многоканальный)

Факс: 8 (812) 320-02-42

Электронная почта: org@eplast1.ru

Адрес: 198099, г. Санкт-Петербург, ул. Калинина, дом 2, корпус 4, литера А.